

Instruction manual

Consumption sensor Typ 8007

with Display, 4 ... 20 mA and Pulse output (galv. isolated)

Stationary and mobile

flow and consumption measurement for compressed air and gases



I. Foreword

Dear customer,

thank you very much for deciding in favour of the Typ 8007. Please read this installation and operation manual carefully before mounting and initiating the device and follow our advice. A riskless operation and a correct functioning of the Typ 8007 are only guaranteed in case of careful observation of the described instructions and notes.



Christian Bürkert GmbH & Co. KG
Christian-Bürkert-Straße 13-17
D-74653 Ingelfingen, Germany

www.burkert.com

II. Table of content

I. Foreword	2
1 Safety instructions	5
2 Instruments description	8
3 Technical data	9
4 Installation	10
4.1 Pipe/tube requirements	10
4.2 Inlet / outlet runs	10
4.3 Installation Typ 8007	11
4.3.1 ½“ welded nipple with ball valve ½“	11
4.3.2 Spot drilling collar with ball valve	11
4.4 Installation of the Sensor	12
4.4.1 Mounting Typ 8007 onto the ball valve	12
4.5 Display Head Position	12
5 Measuring ranges	13
5.1 Maximum Flow Ranges „Low Speed“	14
5.2 Maximum Flow Ranges „Standard“	16
5.3 Maximum Flow ranges „Extended“	18
5.4 Maximum Flow ranges „Maximum“	20
6 Dimension	22
7 Electrical wiring	23
7.1 Electrical wiring	23
8 Operation	24
8.1 Initialization	25
8.2 Main menu	25
8.3 Settings	26
8.3.1 Sensor Setup	27
8.3.1.1 Input / change tube diameter.....	27
8.3.1.2 Input / change consumption counter	28
8.3.1.3 Definition of the units for flow, velocity, temperature and pressure	28
8.3.1.4 Definition of the reference conditions	29
8.3.1.5 Setting of Zeropoint and Low-flow cut off	31
8.3.2 Modbus Setup.....	32
8.3.2.1 Modbus Settings (2001...2005).....	33
8.3.2.2 Values Register (1001 ...1500)	33
8.3.3 Pulse /Alarm.....	35
8.3.3.1 Pulse output.....	35
8.3.4 User Setup	36
8.3.4.1 Password	36
8.3.4.2 Language.....	36
8.3.4.3 Display / Touch.....	37
8.3.5 Advanced.....	37
8.3.6 4 -20mA	38
8.3.7 Typ 8007 Info	40

9	Status / Error messages	41
9.1	Status messages	41
9.2	Error messages	42
10	Maintenance	43
11	Cleaning of the sensor head	43
12	Re-Calibration	43
13	Spare parts and repair	43
14	Calibration	43
15	Warranty	44

1 Safety instructions



Please read carefully before starting the device!

Warning:

Do not exceed the pressure range of 50 bar.
Over 10 bar we recommend using the high-pressure protection for a safe installation and removal.

Observe the measuring ranges of the sensor!

Overheating destroys the sensor.

Observe the admissible storage and transportation temperature as well as the permitted operating temperature (e.g. protect the instrument from direct insolation).

Always observe the direction of flow when positioning the sensor!

The safety ring at the sensor head must always remain undamaged and sit correctly in the destined slot.

The screwed fixture must be pressure tight.

The adapter sleeve must be tightened with a torque of 20 to 30 Nm.

It is necessary to avoid condensation on the sensor element or water drops in the measuring air as they may cause faulty.

The values of the inlet and outlet sections must not fall below the specified minimum values as this causes increased deviations in the measuring results.

The manufacturer cannot be held liable for any damage that occurs because of non-observance or non-compliance with these instructions. Should the device be tampered with in any matter other than a procedure, which is described and specified in the manual, the warranty is cancelled and the manufacturer is exempt from liability.

The device is destined exclusively for the described application.

CS Instruments GmbH offers no guarantee for the suitability for any other purpose and is not liable for errors that may have slipped into this operation manual. CS Instruments GmbH is also not liable for consequential damage resulting from the delivery, capability or use of this device.

We offer you to take back the instruments of the instruments family Typ 8007 which you would like to dispose of.

Qualified employees from the measurement and control technology branch should only carry out adjustments and calibrations.



Please read carefully before starting the device!

The consumption sensor Typ 8007 works according to the calorimetric measuring principle.

Burnable gases

If this consumption sensor is used for measurement of burnable gases (e.g. natural gas) we explicitly point out that the sensor has no DVGW (= German Technical Association for Gas and Water) admission, however, it can be used for natural gas.

A DVGW admission is not mandatory.

The consumption sensor Typ 8007 corresponds with the latest state of technology and can generally be used for burnable and non-burnable gases.

For the use in e.g. natural gas, the sensor will be calibrated in natural gas. The calibration protocol (inspection certificate) is included in the scope of delivery.

The area outside the pipe (environment of the sensor) is **not allowed** to be an explosive area (Ex-area)

The installation has to be done by authorized expert staff.

Please read carefully before starting the device!



The consumption sensor Typ 8007 measures the flow velocity (calorimetric principle) in the center of the pipe. Please observe mounting instruction and inlet section = 15 x inner diameter and outlet section = 5 x inner diameter.

The final values of the measuring ranges are as follows:

Typ 8007 Standard version 92.7 m/s, please take the flow rates from the tables on pages 14-15

Typ 8007 Extended 185 m/s, please take the flow rates from the tables on pages 16-17

Typ 8007 maximum 224 m/s, please take the flow rates from the tables on pages 18-19

1. Typ 8007 with Display with 4... 20 mA analogue- and pulse output

Please enter inner diameter of the pipe!

Values indicated in the display:

Actual value in m³/h, m³/min etc.

Counter in m³, l, cf

as well as pulse output, 1 pulse per m³, l, cf

are calculated according to the set diameter. Please take the analogue value for flow rate 4... 20 mA from the tables on pages 14 to 19

4 mA always corresponds with the starting value 0 m³/h, 0 m³/min. The final value 20 mA can be taken from the tables on pages 14 to 19.

Example Typ 8007 Standard:

1" with inner diameter 25.0 mm, 4 mA = 0 m³/h and 20 mA = 122.2 m³/h

2" with inner diameter 53.1 mm, 4 mA = 0 m³/h und 20 mA = 600.0 m³/h

2. Typ 8007 without Display with 4... 20 mA analogue- and pulse output

No adjustments are necessary at the consumption sensor.

The respective final values for the flow rate can be taken from the tables on the pages 14 to 19. Analogue start value 4 mA is always set as scaling value 0 m³/h, 0 m³/min etc. Analogue end value 20 mA is the final value, see tables pages 14 -19.

Example Typ 8007 Standard:

1" with inner diameter 25.0 mm, 4 mA = 0 m³/h and 20 mA = 122.2 m³/h

2" with inner diameter 53.1 mm, 4 mA = 0 m³/h und 20 mA = 600.0 m³/h

2 Instruments description

The Typ 8007 is a compact consumption counter for compressed air and gases.

Special features:

- Optimum accuracy due to compact design
- Integrated Display showing Flow, consumption, velocity and temperature
- Input inner tube diameter via display keys
- Units free selectable. m³/h, m³/min, l/min, l/s, kg/h, kg/min, kg/s, cfm
- Modbus RTU (RS485) Interface
- Analogoutput 4..20mA
- Pulse output galv. isolated.

PC Service Software

- Analogoutput 4...20 mA scaleable
- Selection of gas type (Air, Nitrogen, Argon, Nitrous oxide, CO₂, Oxygen, Natural gas)
- Read out Service data
- Sensordiagnoses

3 Technical data

Measurement:	Flow, Consumption and Velocity
Selectable Units:	m³/h (Standard settings ex- factory) m ³ /min, l/min, l/s, ft/min, cfm, m/s, kg/h, kg/min, kg/s
Measuring principle:	calorimetric measurement
Sensor:	Pt45, Pt1000
Measuring medium:	Air, gases
Operating temperature:	-30 ... 100°C probe tube -20 ... 70°C housing
Operating pressure:	up to 50 bar
Power supply:	18 to 36 VDC
Power consumption:	max. 5W
Digital output:	RS 485 (Modbus RTU)
Analog output:	4...20 mA (see tables page 13 -18), max. burden < 500 Ohm
Pulse output:	pulse output potential free (dry contact) passive: max. 48Vdc, 150mA 1 pulse pro m ³ resp. pro l, Valency adjustable with the display keys
Accuracy:	± 1,5 % m.v. *, ± 0,3 % f.s. *
Display:	optional TFT 1.8" Resolution 220 x 176
Mounting thread:	G ½"
Material:	Stainless steel 1.4301 / 1.4404
Protection class	IP65

* m.v. = measured values

f.s. = full scale

4 Installation

4.1 Pipe/tube requirements

- Correctly sized gaskets
- Correct aligned flanges and gaskets
- Diameter mismatch at the pipe junctions should be avoided but must be less than 1mm. For further information see ISO 14511
- Ensure clean pipes after installation
- .

4.2 Inlet / outlet runs

In order to maintain the accuracy stipulated in the data sheets, the sensor must be inserted in the centre of a straight pipe section with an undisturbed flow progression.

An undisturbed flow progression is achieved if the sections in front of the sensor (inlet) and behind the sensor (outlet) are sufficiently long, straight and without any obstructions such as edges, seams, curves etc.

Therefore, it is necessary to ensure the recommended inlet and outlet runs.

Table Inlet / Outlet runs

Flow obstruction before the measurement section	Min length Inlet run (L1)	Min length Outlet run (L2)
Slight curve (elbow < 90°)	12 x D	5 x D
Reduction (Pipe narrows to the measurement section)	15 x D	5 x D
Expansion (Pipe expands to the measurement section)	15 x D	5 x D
90° elbow or T-piece	15 x D	5 x D
2x elbow á 90° in einer Ebene	20 x D	5 x D
2x elbow á 90° 3-dimensional	35 x D	5 x D
Control valve	45 x D	5 x D

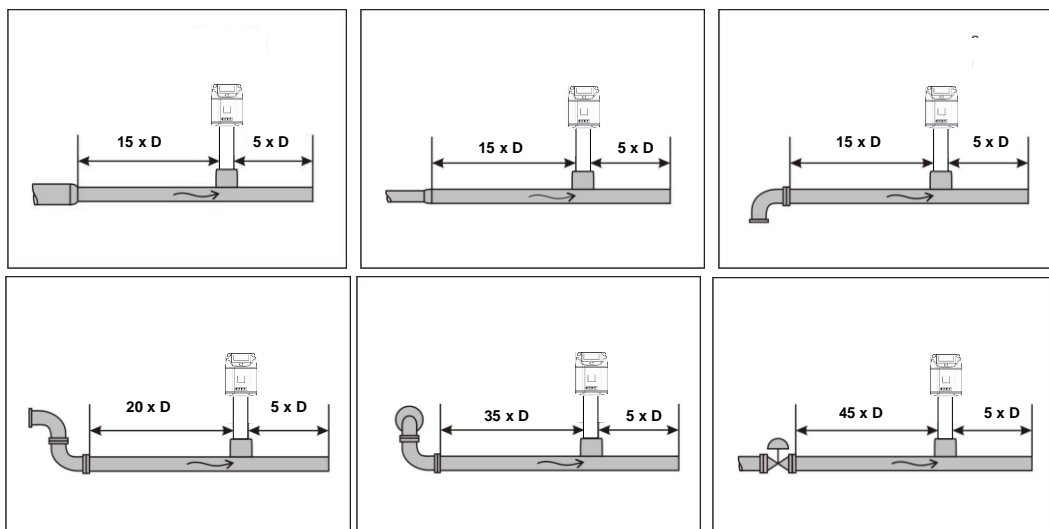

The values represent the min. lengths. In case the min. inlet / outlet runs could not be ensured, it must be expected to get increased or significant deviations of the measurement values.

4.3 Installation Typ 8007

The installation of the sensor is done via a ball valve 1/2".

If no valid measuring point with a ball valve 1/2" is available there are following ways to set up a measuring point.



When using the consumption sensor in systems with working pressure > 10 bar, for safety reasons the use of a high pressure protection is required.

4.3.1 1/2" welded nipple with ball valve 1/2"



Important:

Ensure that the system is in shut down, ie. depressurized.

Note for installation with ball valve

Ball valve R 1/2", DN 15

Passage ball valve: Minimum Ø15 mm

4.3.2 Spot drilling collar with ball valve



In case the system could not be shut down, means to be set depressurized, there could be used the spot drilling collar and drilling jig to drill through the ball valve.

4.4 Installation of the Sensor

4.4.1 Mounting Typ 8007 onto the ball valve

- Assembly is carried out by inserting the connection thread with gasket. (G1/2" thread, SW 32) into the connection piece (ball valve).
The sensor has to be tightened by hand as far as possible and then tightened with stipulated torque of 25-30 Nm.
It must be ensured that the installation is pressure-tight.



- The sensor is then inserted to the required immersion depth and aligned according to the direction of the airflow.
A depth scale engraved on the probe tube, a flow alignment arrow and an aligning device will be of help for you.
Once the sensor has been aligned the adapter sleeve must be tightened with stipulated torque of 20-30Nm (SW 17).

Attention: Alignment of the sensor must not be modified when tightening the connection thread and adapter sleeve. In this case, please check the immersion depth and alignment again and correct it if necessary. The angular deviation should not be greater than $\pm 2^\circ$ in relation to ideal position as otherwise the measuring accuracy will decrease.

Calculation mounting depth:

Alignment flow direction

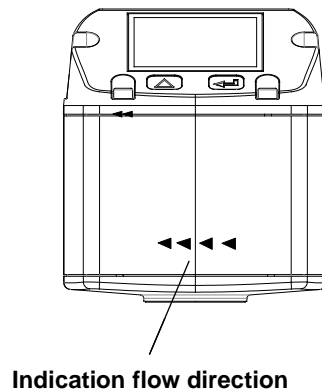
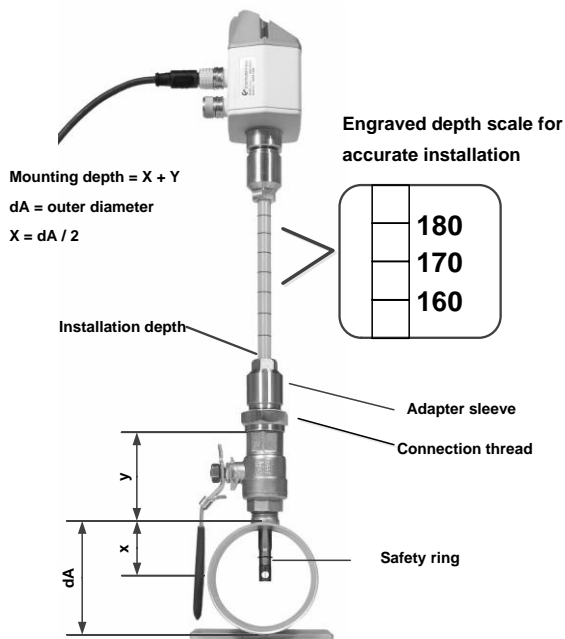

4.5 Display Head Position

Fastening screws

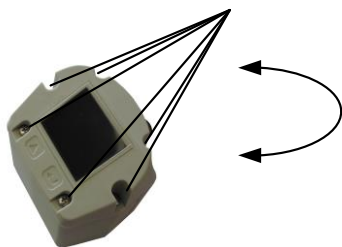

The Position of the Display head is twistable by 180 e.g. in case of reverse flow direction.
For this purpose the 6 fastening screws are to be released and the display head rotated 180°.

Caution:

It must be ensured that the connection plugs are still plugged and the gasket is installed correctly.

5 Measuring ranges

The consumption sensor Type 8007 is available in 4 different versions:

- Low Speed max. measuring range of 50 m/s
- Standard max. measuring range of 92,7 m/s
- Extended max. measuring range of 185.0 m/s
- Maximum max. measuring range of 224 m/s

The sensors are **programmed to pipe inner diameter of 53,1 mm.**

	Measuring range	Analogoue output Scaling
• Low Speed	0 ... 323,6 m ³ /h	4mA = 0 m ³ h, 20mA = 323,6 m ³ /h
• Standard	0 ... 600 m ³ /h	4mA = 0 m ³ h, 20mA = 600 m ³ /h
• Extended	0 ... 1197,59 m ³ /h	4mA = 0 m ³ h, 20mA = 1197,59 m ³ /h
• Maximum	0 ... 1450,06 m ³ /h	4mA = 0 m ³ h, 20mA = 1450,06 m ³ /h

In case of use in **other** inner pipe diameter the diameter, using the display version, the diameter has to be set first.

The corresponding scale values for the respective version could be found in sections 5.1 to 5.3.

Example:

Pipe 1", Inner diameter 25mm

	Measuring range	Analogoue output Scaling
• Low Speed	0 ... 65,9 m ³ /h	4mA = 0 m ³ h, 20mA = 65,9 m ³ /h
• Standard	0 ... 122,2 m ³ /h	4mA = 0 m ³ h, 20mA = 122,2 m ³ /h
• Extendedn	0 ... 243,88 m ³ /h	4mA = 0 m ³ h, 20mA = 243,88 m ³ /h
• Maximum	0 ... 295,30 m ³ /h	4mA = 0 m ³ h, 20mA = 295,30 m ³ /h

Please note:

The consumption Type 8007 corresponds with the latest state of technology and can generally be used for burnable and non-burnable gases.

If this consumption sensor is used for measurement of burnable gases (e.g. natural gas) we explicitly point out that the sensor has no DVGW admission, however, it can be used for burnable gases. A DVGW admission is not mandatory.

For the use in e.g. natural gas, the sensor will be calibrated in natural gas. The calibration protocol (inspection certificate) is included in the scope of delivery.

The area outside the pipe (environment of the sensor) is **not allowed** to be an explosive area. (Ex area)

5.1 Maximum Flow Ranges „Low Speed“

Inner diameter of the pipe		Flow (final value of measuring range in Nm ³ /h)								Max.
Inch	mm	Air ²⁾	Air ³⁾	Ar ³⁾	CO ₂ ³⁾	N ₂ ³⁾	O ₂ ³⁾	N ₂ O ³⁾	Natural gas ³⁾	m/s
1/4"	6,0	2,5	2,3	4,0	2,5	2,3	2,4	2,5	1,5	50
	10,0	8,1	7,5	12,7	8,0	7,5	7,8	8,0	4,8	50
	15,0	21,0	19,3	32,8	20,8	19,3	20,0	20,6	12,4	50
1/2"	16,1	24,6	22,6	38,5	24,3	22,6	23,5	24,1	14,5	50
	3/4"	21,7	48,1	44,2	75,1	47,5	44,2	45,8	47,1	50
1"	25,0	65,9	60,6	103,0	65,2	60,6	62,8	64,6	38,9	50
	26,0	71,7	65,9	112,0	70,9	65,9	68,3	70,3	42,4	50
	27,3	79,6	73,2	124,5	78,8	73,2	75,9	78,1	47,1	50
	28,5	87,4	80,3	136,6	86,5	80,3	83,3	85,7	51,7	50
	30,0	97,6	89,7	152,5	96,5	89,7	93,0	95,7	57,7	50
1 1/4"	32,8	118,0	108,5	184,5	116,8	108,5	112,6	115,7	69,8	50
	36,0	143,6	132,0	224,5	142,1	132,0	137,0	140,8	84,9	50
	36,3	146,0	134,4	228,6	144,7	134,4	139,4	143,4	86,5	50
1 1/2"	39,3	172,7	159,0	270,3	171,1	159,0	164,9	169,6	102,2	50
	40,0	179,3	164,9	280,4	177,5	164,9	171,0	175,9	106,0	50
	41,9	197,8	181,0	307,7	194,8	181,0	187,8	193,0	116,4	50
	43,1	210,0	193,1	328,4	207,8	193,1	200,3	206,0	124,2	50
	45,8	238,3	219,1	372,7	235,9	219,1	227,3	233,8	140,9	50
2"	50,0	286,2	263,1	447,5	283,2	263,1	273,0	280,7	169,3	50
	51,2	300,5	276,2	469,8	297,3	276,2	286,6	294,7	177,7	50
	53,1	323,6	297,5	505,9	320,2	297,5	308,7	317,4	191,3	50
	54,5	341,3	313,8	533,6	337,7	313,8	325,6	334,7	201,8	50
	57,5	381,8	370,0	629,2	398,2	370,0	383,9	394,7	238,0	50
	60,0	417,3	383,5	652,3	412,8	383,5	398,0	409,2	246,7	50
	64,2	479,4	440,8	749,6	474,4	440,8	457,3	470,2	283,5	50

²⁾ Referred to DIN 1945 / ISO 1217 (20°C, 1000mbar) and compressed air.

³⁾ Referred to DIN 1343: 0°C, 1013,25 mbar

MAN 1000539696 - EN Version: - Status: RL (released / freigegeben) - printed: 09.09.2026

Inner diameter of the pipe		Flow (final value of measuring range in Nm ³ /h)								Max.
Inch	mm	Air ²⁾	Air ³⁾	Ar ³⁾	CO ₂ ³⁾	N ₂ ³⁾	O ₂ ³⁾	N ₂ O ³⁾	Natural gas ³⁾ Methan	m/s
2 1/2"	65,0	492,7	452,4	769,3	486,8	452,4	469,4	482,6	290,9	50
	70,3	577,7	531,1	903,2	571,6	531,1	551,0	566,6	341,6	50
	71,1	590,6	543,2	923,8	584,6	543,2	563,6	579,6	349,4	50
3"	76,1	678,5	623,8	1060,9	671,4	623,8	647,2	665,5	401,2	50
	80,0	749,7	690,2	1173,8	742,9	690,2	716,1	736,4	444,0	50
	82,5	798,3	734,9	1249,8	791,0	734,9	762,5	784,1	472,7	50
4"	84,9	846,3	778,3	1323,6	837,6	778,3	807,5	830,4	500,6	50
	90,0	952,5	875,7	1489,2	942,4	875,7	908,5	934,3	563,2	50
	100,0	1177,5	1082,4	1840,8	1164,9	1082,4	1123,0	1154,7	696,2	50
5"	107,1	1352,2	1243,0	2114,0	1337,8	1243,0	1289,7	1326,2	799,5	50
	110,0	1426,1	1311,2	2230,0	1411,3	1311,2	1360,5	1398,9	843,4	50
	125,0	1846,3	1695,3	2883,1	1824,5	1695,3	1758,9	1808,6	1090,3	50
6"	133,7	2114,9	1939,4	3298,4	2087,4	1939,4	2012,2	2069,1	1247,4	50
	150,0	2665,0	2444,1	4156,6	2630,5	2444,1	2535,9	2607,6	1572,0	50
	159,3	3009,2	2756,5	4688,0	2966,8	2756,5	2860,0	2940,9	1773,0	50
8"	182,5	3949,8	3622,2	6160,3	3898,5	3622,2	3758,3	3864,6	2329,8	50
	190,0	4286,4	3926,1	6677,0	4225,6	3926,1	4073,5	4188,7	2525,2	50
	200,0	4755,1	4355,4	7407,2	4687,6	4355,4	4519,0	4646,8	2801,3	50
10"	206,5	5069,0	4643,1	7896,5	4997,3	4643,1	4817,5	4953,7	2986,4	50
	250,0	7412,1	6813,4	11587,6	7333,2	6813,4	7069,3	7269,3	4382,3	50
	260,4	8060,9	7400,9	12586,7	7965,5	7400,9	7678,9	7896,0	4760,2	50
12"	300,0	10699,0	9823,0	16706,0	10572,4	9823,0	10192,0	10480,2	6318,1	50
	309,7	11401,8	10468,5	17803,8	11267,2	10468,5	10861,7	11168,8	6733,3	50
	339,6	13709,8	12587,4	21407,5	13547,7	12587,4	13060,2	13429,6	8096,1	50
15"	388,8	17970,3	17463,1	29699,6	18795,4	17463,1	18119,0	18631,4	11232,1	50
	500,0	29720,1	27286,1	46405,6	29367,8	27286,1	28310,9	29111,6	17550,2	50
	600,0	42796,7	39292,0	66824,1	42289,6	39292,0	40767,7	41920,7	25272,3	50
18"	700,0	58251,3	53480,7	90955,0	57560,9	53480,7	55489,4	57058,7	34398,4	50
	800,0	76083,1	69852,4	118798,3	75181,6	69852,4	72476,0	74525,7	44928,5	50
	900,0	96292,9	88407,0	150354,1	95151,6	88407,0	91727,5	94321,5	56862,7	50
24"	1000,0	118880,3	109144,4	185622,4	117471,1	109144,4	113243,7	116446,3	70200,9	50

²⁾ Referred to DIN 1945 / ISO 1217 (20°C, 1000mbar) and compressed air.

³⁾ Referred to DIN 1343: 0°C, 1013,25 mbar

MAN 1000530696 EN Version: Status: RL (released / freigegeben) printed: 09.03.2020

5.2 Maximum Flow Ranges „Standard“

Inner diameter of the pipe		Flow (final value of measuring range in Nm ³ /h)								Max.
Inch	mm	Air ²⁾	Air ³⁾	Ar ³⁾	CO ₂ ³⁾	N ₂ ³⁾	O ₂ ³⁾	N ₂ O ³⁾	Natural gas ³⁾ Methan	m/s
1/4"	6,0	4,7	4,3	7,4	4,7	4,3	4,5	4,6	2,8	92,7
	10,0	15,1	13,9	23,6	14,9	13,9	14,4	14,8	8,9	92,7
	15,0	38,9	35,8	60,8	38,5	35,8	37,1	38,2	23,0	92,7
1/2"	16,1	45,6	41,9	71,3	45,1	41,9	43,5	44,7	26,9	92,7
3/4"	21,7	89,1	81,9	139,3	88,1	81,9	85,0	87,4	52,7	92,7
1"	25,0	122,2	112,3	191,0	120,9	112,3	116,5	119,8	72,2	92,7
	26,0	132,9	122,1	207,7	131,5	122,1	126,7	130,3	78,6	92,7
	27,3	147,5	135,7	230,8	146,1	135,7	140,8	144,8	87,3	92,7
	28,5	162,0	148,9	253,2	160,3	148,9	154,5	158,9	95,8	92,7
	30,0	180,9	166,3	282,8	179,0	166,3	172,5	177,4	107,0	92,7
1 1/4"	32,8	218,8	201,1	342,0	216,5	201,1	208,7	214,6	129,4	92,7
	36,0	266,3	244,8	416,3	263,4	244,8	254,0	261,1	157,4	92,7
	36,3	270,7	249,2	423,8	268,2	249,2	258,5	265,9	160,3	92,7
1 1/2"	39,3	320,1	294,7	501,2	317,2	294,7	305,7	314,4	189,5	92,7
	40,0	332,5	305,7	519,8	329,0	305,7	317,1	326,1	196,6	92,7
	41,9	366,7	335,5	570,5	361,1	335,5	348,1	357,9	215,8	92,7
	43,1	389,4	358,0	608,8	385,3	358,0	371,4	381,9	230,3	92,7
	45,8	441,9	406,3	691,0	437,3	406,3	421,5	433,5	261,3	92,7
2"	50,0	530,6	487,8	829,6	525,0	487,8	506,1	520,5	313,8	92,7
	51,2	557,1	512,1	871,0	551,2	512,1	531,4	546,4	329,4	92,7
	53,1	600,0	551,5	938,0	593,6	551,5	572,3	588,4	354,7	92,7
	54,5	632,8	581,7	989,3	626,1	581,7	603,6	620,6	374,2	92,7
	57,5	707,8	685,9	1166,6	738,3	685,9	711,7	731,8	441,2	92,7
	60,0	773,6	711,1	1209,4	765,4	711,1	737,8	758,7	457,4	92,7
	64,2	888,9	817,2	1389,7	879,5	817,2	847,8	871,8	525,6	92,7

²⁾ Referred to DIN 1945 / ISO 1217 (20°C, 1000mbar) and compressed air.

³⁾ Referred to DIN 1343: 0°C, 1013,25 mbar

Inner diameter of the pipe		Flow (final value of measuring range in Nm ³ /h)								Max.
Inch	mm	Air ²⁾	Air ³⁾	Ar ³⁾	CO ₂ ³⁾	N ₂ ³⁾	O ₂ ³⁾	N ₂ O ³⁾	Natural gas ³⁾ Methan	m/s
2 1/2"	65,0	913,5	838,7	1426,3	902,6	838,7	870,2	894,8	539,4	92,7
	70,3	1071	984,6	1674,5	1059,7	984,6	1021,6	1050,4	633,3	92,7
	71,1	1095	1007,1	1712,8	1083,9	1007,1	1044,9	1074,5	647,8	92,7
	76,1	1258	1156,5	1966,9	1244,8	1156,5	1200,0	1233,9	743,9	92,7
3"	80,0	1390	1279,6	2176,3	1377,3	1279,6	1327,7	1365,3	823,1	92,7
	82,5	1480	1362,5	2317,2	1466,5	1362,5	1413,7	1453,7	876,4	92,7
	84,9	1569	1442,9	2454,0	1553,0	1442,9	1497,1	1539,5	928,1	92,7
	90,0	1766	1623,5	2761,0	1747,3	1623,5	1684,4	1732,1	1044,2	92,7
4"	100,0	2183	2006,7	3412,8	2159,8	2006,7	2082,0	2140,9	1290,7	92,7
	107,1	2507	2304,5	3919,3	2480,3	2304,5	2391,1	2458,7	1482,2	92,7
	110,0	2644	2431,0	4134,4	2616,5	2431,0	2522,3	2593,6	1563,6	92,7
	125,0	3423	3143,0	5345,2	3382,7	3143,0	3261,0	3353,2	2021,5	92,7
5"	133,7	3921	3595,7	6115,2	3870,0	3595,7	3730,7	3836,2	2312,7	92,7
	150,0	4941	4531,3	7706,4	4877,0	4531,3	4701,5	4834,4	2914,5	92,7
	159,3	5579	5110,6	8691,6	5500,5	5110,6	5302,5	5452,5	3287,1	92,7
	182,5	7323	6715,6	11421,2	7227,9	6715,6	6967,8	7164,9	4319,4	92,7
6"	190,0	7947	7278,9	12379,2	7834,2	7278,9	7552,3	7765,8	4681,7	92,7
	200,0	8816	8074,9	13733,0	8690,9	8074,9	8378,2	8615,1	5193,7	92,7
	206,5	9398	8608,3	14640,1	9265,0	8608,3	8931,6	9184,2	5536,8	92,7
	250,0	13742	12632,1	21483,4	13595,8	12632,1	13106,5	13477,2	8124,8	92,7
8"	260,4	14945	13721,2	23335,8	14768,0	13721,2	14236,6	14639,2	8825,4	92,7
	300,0	19836	18211,8	30972,9	19601,2	18211,8	18895,9	19430,2	11713,7	92,7
	309,7	21139	19408,6	33008,2	20889,3	19408,6	20137,5	20707,0	12483,5	92,7
	339,6	25418	23337,1	39689,5	25117,5	23337,1	24213,6	24898,4	15010,2	92,7
10"	388,8	33317	32376,6	55063,0	34846,6	32376,6	33592,6	34542,6	20824,4	92,7
	500,0	55101	50588,4	86036,0	54447,9	50588,4	52488,5	53972,9	32538,1	92,7
	600,0	79345	72847,4	123891,8	78405,0	72847,4	75583,4	77720,9	46854,9	92,7
	700,0	107998	99153,3	168630,5	106717,9	99153,3	102877,4	105786,8	63774,7	92,7
12"	800,0	141058	129506,4	220252,1	139386,6	129506,4	134370,5	138170,6	83297,5	92,7
	900,0	178527	163906,5	278756,5	176411,1	163906,5	170062,7	174872,1	105423,5	92,7
	1000,0	220404	202353,8	344143,9	217791,5	202353,8	209953,9	215891,5	130152,4	92,7

²⁾ Referred to DIN 1945 / ISO 1217 (20°C, 1000mbar) and compressed air.

³⁾ Referred to DIN 1343: 0°C, 1013,25 mbar

MAN 1000530696 EN Version: Status: RL (released / freigegeben) printed: 09.03.2020

5.3 Maximum Flow ranges „Extended“

Inner diameter of the pipe		Flow (final value of measuring range in Nm ³ /h)								Max.
Inch	mm	Air ²⁾	Air ³⁾	Ar ³⁾	CO ₂ ³⁾	N ₂ ³⁾	O ₂ ³⁾	N ₂ O ³⁾	Natural gas ³⁾ Methan	m/s
1/4"	6,0	9,42	8,7	14,7	9,3	8,7	9,0	9,2	5,6	185,0
	10,0	30,08	27,7	47,0	29,8	27,7	28,7	29,5	17,8	185,0
	15,0	77,68	71,4	121,4	76,9	71,4	74,1	76,2	45,9	185,0
1/2"	16,1	90,98	83,7	142,2	90,0	83,7	86,7	89,2	53,8	185,0
	21,7	177,84	163,5	278,0	176,0	163,5	169,6	174,4	105,2	185,0
1"	25,0	243,88	224,2	381,2	241,4	224,2	232,5	239,1	144,2	185,0
	26,0	265,20	243,8	414,6	262,5	243,8	252,9	260,0	156,8	185,0
	27,3	294,72	271,0	460,7	291,7	271,0	281,0	289,0	174,3	185,0
1 1/4"	28,5	323,32	297,3	505,4	320,0	297,3	308,3	317,0	191,2	185,0
	30,0	361,08	332,0	564,5	357,4	332,0	344,3	354,1	213,5	185,0
	32,8	436,69	401,5	682,7	432,2	401,5	416,4	428,2	258,2	185,0
1 1/2"	36,0	531,48	488,7	830,8	526,0	488,7	506,8	521,1	314,3	185,0
	36,3	541,06	497,5	845,8	535,5	497,5	515,9	530,5	320,0	185,0
	39,3	639,84	588,3	1000,2	633,3	588,3	610,1	627,4	378,4	185,0
2"	40,0	663,68	610,2	1037,5	656,9	610,2	632,8	650,8	392,5	185,0
	41,9	728,41	669,7	1138,7	720,9	669,7	694,5	714,2	430,7	185,0
	43,1	777,34	714,7	1215,2	769,4	714,7	741,2	762,2	459,7	185,0
2"	45,8	882,17	811,1	1379,0	873,1	811,1	841,2	865,0	521,7	185,0
	50,0	1059,23	973,9	1655,8	1048,3	973,9	1010,0	1038,6	626,4	185,0
	51,2	1112,05	1022,5	1738,4	1100,6	1022,5	1060,4	1090,4	657,6	185,0
2"	53,1	1197,59	1101,1	1872,1	1185,3	1101,1	1141,9	1174,3	708,2	185,0
	54,5	1263,13	1161,4	1974,6	1250,2	1161,4	1204,4	1238,5	747,0	185,0
	57,5	1489,43	1369,5	2328,3	1474,1	1369,5	1420,2	1460,5	880,8	185,0
2"	60,0	1544,12	1419,8	2413,8	1528,3	1419,8	1472,3	1514,1	913,1	185,0
	64,2	1774,33	1631,4	2773,7	1756,1	1631,4	1691,8	1739,8	1049,3	185,0

²⁾ Referred to DIN 1945 / ISO 1217 (20°C, 1000mbar) and compressed air.

³⁾ Referred to DIN 1343: 0°C, 1013,25 mbar

Inner diameter of the pipe		Flow (final value of measuring range in Nm ³ /h)								Max.
Inch	mm	Air ²⁾	Air	Ar ³⁾	CO ₂ ³⁾	N ₂ ³⁾	O ₂ ³⁾	N ₂ O ³⁾	Natural gas ³⁾ Methan	m/s
2 1/2"	65,0	1821,03	1674,4	2846,7	1802,3	1674,4	1736,4	1785,6	1076,9	185,0
	70,3	2137,86	1965,7	3342,0	2115,9	1965,7	2038,5	2096,3	1264,2	185,0
	71,1	2186,80	2010,7	3418,5	2164,3	2010,7	2085,1	2144,2	1293,2	185,0
3"	76,1	2511,24	2309,0	3925,7	2485,4	2309,0	2394,5	2462,4	1485,0	185,0
	80,0	2778,58	2554,8	4343,6	2750,0	2554,8	2649,4	2724,5	1643,1	185,0
	82,5	2958,51	2720,2	4624,9	2928,1	2720,2	2821,0	2900,9	1749,5	185,0
4"	84,9	3133,15	2880,8	4897,9	3101,0	2880,8	2987,5	3072,2	1852,8	185,0
	90,0	3525,11	3241,2	5510,6	3488,9	3241,2	3361,2	3456,5	2084,6	185,0
	100,0	4357,22	4006,3	6811,4	4312,5	4006,3	4154,7	4272,4	2576,6	185,0
5"	107,1	5003,91	4600,9	7822,3	4952,5	4600,9	4771,3	4906,5	2959,1	185,0
	110,0	5278,56	4853,4	8251,7	5224,3	4853,4	5033,2	5175,8	3121,5	185,0
	125,0	6824,50	6274,8	10668,3	6754,4	6274,8	6507,2	6691,7	4035,7	185,0
6"	133,7	7807,53	7178,7	12205,1	7727,3	7178,7	7444,6	7655,6	4617,0	185,0
	150,0	9839,04	9046,6	15380,8	9738,0	9046,6	9381,7	9647,6	5818,3	185,0
	159,3	11096,91	10203,2	17347,2	10982,9	10203,2	10581,1	10881,0	6562,2	185,0
8"	182,5	14581,94	13407,5	22795,1	14432,2	13407,5	13904,1	14298,2	8623,0	185,0
	190,0	15805,08	14532,1	24707,2	15642,8	14532,1	15070,4	15497,5	9346,4	185,0
	200,0	17533,48	16121,3	27409,1	17353,4	16121,3	16718,4	17192,3	10368,4	185,0
10"	206,5	18691,68	17186,2	29219,6	18499,7	17186,2	17822,8	18327,9	11053,3	185,0
	250,0	27428,75	25219,6	42877,8	27147,1	25219,6	26153,7	26895,0	16220,0	185,0
	260,4	29793,76	27394,2	46574,9	29487,8	27394,2	28408,8	29214,0	17618,6	185,0
12"	300,0	39544,48	36359,5	61817,6	39138,4	36359,5	37706,2	38775,0	23384,7	185,0
	309,7	42143,03	38748,8	65879,8	41710,2	38748,8	40184,0	41323,0	24921,3	185,0
	339,6	50673,25	46592,0	79214,6	50152,8	46592,0	48317,6	49687,2	29965,7	185,0
15"	388,8	70301,30	64639,2	109898,0	69579,3	64639,2	67033,2	68933,3	41572,8	185,0
	500,0	109845,79	100998,7	171715,7	108717,6	100998,7	104739,4	107708,2	64957,5	185,0
	600,0	158177,93	145438,2	247270,6	156553,4	145438,2	150824,8	155099,9	93538,7	185,0
20"	700,0	215297,74	197957,5	336562,7	213086,6	197957,5	205289,3	211108,2	127316,6	185,0
	800,0	281205,22	258556,8	439592,2	278317,2	258556,8	268133,0	275733,1	166291,1	185,0
	900,0	355900,35	327235,9	556358,8	352245,2	327235,9	339355,8	348974,7	210462,2	185,0
24"	1000,0	439383,15	403995,0	686862,7	434870,6	403995,0	418957,8	430833,0	259829,8	185,0

²⁾ Referred to DIN 1945 / ISO 1217 (20°C, 1000mbar) and compressed air.

³⁾ Referred to DIN 1343: 0°C, 1013,25 mbar

MAN 1000530096 EN Version: Status: RL (released / freigegeben) printed: 09.03.2020

5.4 Maximum Flow ranges „Maximum“

Inner diameter of the pipe		Flow (final value of measuring range in Nm ³ /h)								Max.
Inch	mm	Air ²⁾	Air	Ar ³⁾	CO ₂ ³⁾	N ₂ ³⁾	O ₂ ³⁾	N ₂ O ³⁾	Natural gas ³⁾ Methan	m/s
1/4"	6,0	11,40	10,5	17,8	11,3	10,5	10,9	11,2	6,7	224,0
	10,0	36,42	33,5	56,9	36,0	33,5	34,7	35,7	21,5	224,0
	15,0	94,05	86,5	147,0	93,0	86,5	89,7	92,2	55,6	224,0
	16,1	110,16	101,3	172,2	109,0	101,3	105,0	108,0	65,2	224,0
3/4"	21,7	215,33	198,0	336,6	213,0	198,0	205,3	211,2	127,4	224,0
	1"	25,0	295,30	271,6	461,7	292,1	271,6	281,6	289,6	174,7
1 1/4"	26,0	321,11	295,3	502,0	317,7	295,3	306,2	314,9	189,9	224,0
	27,3	356,85	328,2	557,9	353,0	328,2	340,3	350,0	211,1	224,0
	28,5	391,48	360,0	612,0	387,3	360,0	373,3	384,0	231,6	224,0
	30,0	437,20	402,1	683,5	432,5	402,1	416,9	428,8	258,6	224,0
	32,8	528,75	486,3	826,6	523,1	486,3	504,2	518,6	312,8	224,0
	36,0	643,52	591,8	1006,1	636,6	591,8	613,6	631,2	380,7	224,0
1 1/2"	36,3	655,12	602,5	1024,2	648,1	602,5	624,7	642,5	387,5	224,0
	39,3	774,73	712,5	1211,2	766,4	712,5	738,8	759,9	458,3	224,0
	40,0	803,59	739,0	1256,3	795,0	739,0	766,3	788,2	475,3	224,0
	41,9	881,96	811,1	1378,9	872,5	811,1	841,0	865,0	521,7	224,0
	43,1	941,21	865,6	1471,5	931,1	865,6	897,5	923,1	556,7	224,0
2"	45,8	1068,14	982,3	1669,9	1056,7	982,3	1018,5	1047,6	631,8	224,0
	50,0	1282,52	1179,5	2005,1	1268,8	1179,5	1223,0	1257,9	758,6	224,0
	51,2	1346,48	1238,3	2105,1	1332,1	1238,3	1284,0	1320,6	796,5	224,0
	53,1	1450,06	1333,5	2267,0	1434,5	1333,5	1382,7	1422,2	857,7	224,0
	54,5	1529,41	1406,5	2391,1	1513,0	1406,5	1458,4	1500,1	904,7	224,0
	57,5	1803,42	1658,5	2819,5	1784,1	1658,5	1719,7	1768,8	1066,8	224,0
	60,0	1869,63	1719,4	2923,0	1849,6	1719,4	1782,8	1833,7	1105,9	224,0
64,2	2148,38	1975,7	3358,8	2125,4	1975,7	2048,6	2107,1	1270,8	224,0	

²⁾ Referred to DIN 1945 / ISO 1217 (20°C, 1000mbar) and compressed air.

³⁾ Referred to DIN 1343: 0°C, 1013,25 mbar

Inner diameter of the pipe		Flow (final value of measuring range in Nm ³ /h)								Max.
Inch	mm	Air ²⁾	Air	Ar ³⁾	CO ₂ ³⁾	N ₂ ³⁾	O ₂ ³⁾	N ₂ O ³⁾	Natural gas ³⁾ Methan	m/s
2 1/2"	65,0	2204,93	2027,7	3447,2	2181,3	2027,7	2102,6	2162,6	1304,3	224,0
	70,3	2588,55	2380,5	4046,9	2560,8	2380,5	2468,4	2538,9	1531,2	224,0
	71,1	2647,80	2435,0	4139,6	2619,4	2435,0	2524,9	2597,0	1566,2	224,0
	76,1	3040,63	2796,3	4753,7	3008,1	2796,3	2899,5	2982,3	1798,6	224,0
	80,0	3364,33	3094,0	5259,8	3328,3	3094,0	3208,1	3299,7	1990,1	224,0
	82,5	3582,20	3294,3	5600,4	3543,8	3294,3	3415,9	3513,4	2118,9	224,0
3"	84,9	3793,65	3488,8	5931,0	3753,0	3488,8	3617,5	3720,8	2244,0	224,0
	90,0	4268,24	3925,3	6672,9	4222,5	3925,3	4070,1	4186,3	2524,7	224,0
	100,0	5275,76	4851,8	8248,1	5219,2	4851,8	5030,8	5174,5	3120,7	224,0
4"	107,1	6058,78	5571,9	9472,3	5993,9	5571,9	5777,5	5942,5	3583,9	224,0
	110,0	6391,34	5877,7	9992,2	6322,9	5877,7	6094,6	6268,6	3780,6	224,0
	125,0	8263,17	7599,2	12918,6	8174,6	7599,2	7879,5	8104,6	4887,8	224,0
5"	133,7	9453,44	8693,8	14779,4	9352,1	8693,8	9014,5	9272,0	5591,9	224,0
	150,0	11913,22	10955,9	18625,0	11785,6	10955,9	11360,1	11684,5	7046,9	224,0
	159,3	13436,25	12356,6	21006,1	13292,3	12356,6	12812,4	13178,3	7947,8	224,0
	182,5	17655,97	16237,2	27603,2	17466,8	16237,2	16836,2	17317,0	10443,8	224,0
	190,0	19136,96	17599,2	29918,6	18931,9	17599,2	18248,5	18769,6	11319,9	224,0
	200,0	21229,73	19523,8	33190,4	21002,3	19523,8	20244,1	20822,2	12557,8	224,0
8"	206,5	22632,08	20813,4	35382,8	22389,6	20813,4	21581,3	22197,6	13387,3	224,0
	250,0	33211,03	30542,3	51921,9	32855,2	30542,3	31669,1	32573,5	19644,9	224,0
	260,4	36074,61	33175,8	56398,8	35688,1	33175,8	34399,7	35382,1	21338,8	224,0
10"	300,0	47880,89	44033,3	74856,6	47367,9	44033,3	45657,8	46961,7	28322,4	224,0
	309,7	51027,24	46926,8	79775,6	50480,5	46926,8	48658,1	50047,7	30183,5	224,0
	339,6	61355,72	56425,3	95923,1	60698,3	56425,3	58507,1	60177,9	36293,0	224,0
	388,8	85121,58	78281,5	133078,5	84209,6	78281,5	81169,5	83487,5	50350,9	224,0
	500,0	133002,47	122314,8	207935,1	131577,4	122314,8	126827,4	130449,3	78673,3	224,0
	600,0	191523,55	176133,3	299426,6	189471,5	176133,3	182631,4	187847,0	113289,6	224,0
12"	700,0	260684,83	239736,9	407552,8	257891,8	239736,9	248581,6	255680,6	154199,7	224,0
	800,0	340486,31	313125,8	532313,9	336838,2	313125,8	324678,0	333950,2	201403,7	224,0
	900,0	430927,99	396299,8	673709,7	426310,9	396299,8	410920,6	422655,7	254901,6	224,0
	1000,0	532009,87	489259,1	831740,4	526309,8	489259,1	507309,4	521797,2	314693,3	224,0

²⁾ Referred to DIN 1945 / ISO 1217 (20°C, 1000mbar) and compressed air.

³⁾ Referred to DIN 1343: 0°C, 1013,25 mbar

MAN 1000530096 EN Version: Status: RL (released / freigegeben) printed: 09.03.2020

6 Dimension

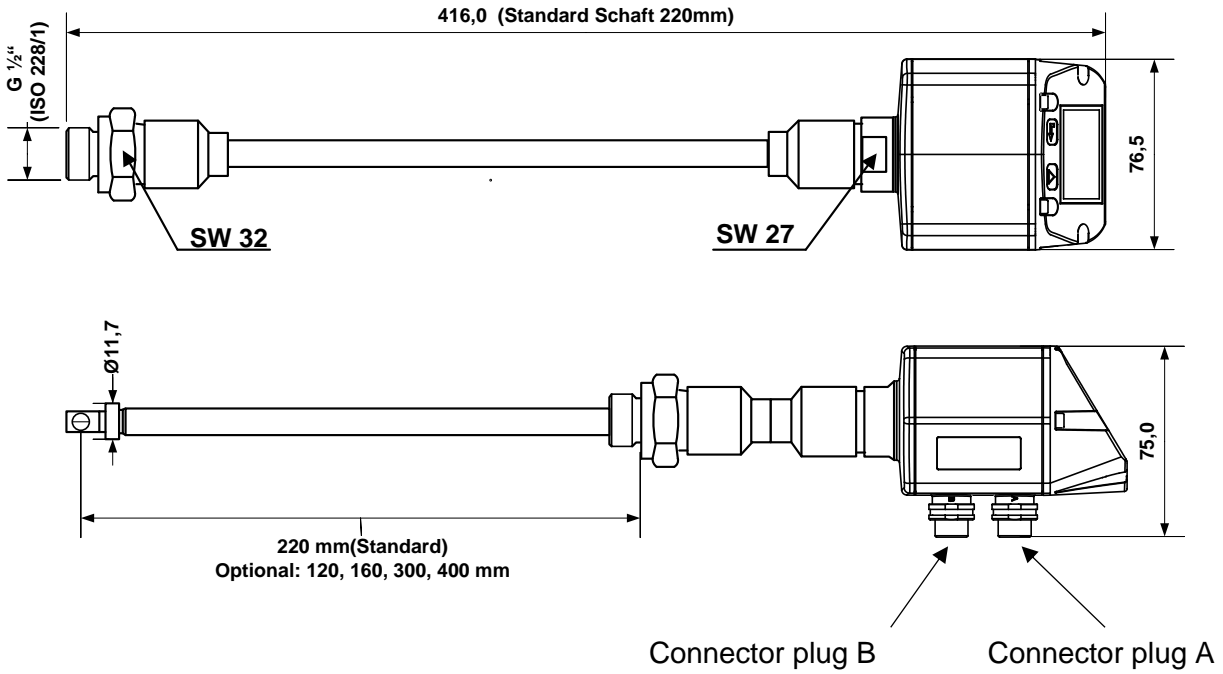

MAN 1000539696 EN Version: - Status: RL (released | freigegeben) printed: 09.03.2026

7 Electrical wiring

7.1 Electrical wiring

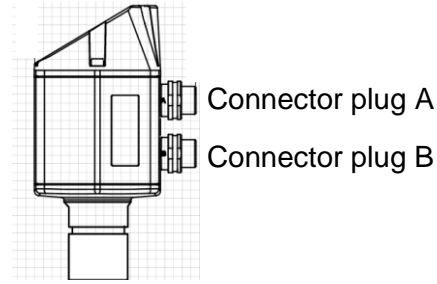

Attention: Not required connections NC must not be connected to a voltage and/or to protection earth. Cut and insulate cables.

	Pin 1	Pin 2	Pin 3	Pin 4	Pin 5
Connector plug A	+VB	RS 485 (A)	-VB	RS 485 (B)	I+ 4..20 mA
Connector plug B Pulse output (standard)	NC	GND	DIR	Pulse galv. isolated	Pulse galv. isolated
Colours pulse cables 0553.0106 (5 m) 0553.0107 (10 m)	brown	white	blue	black	grey

Legend:

-VB	Negative supply voltage 0 V
+VB	Positive supply voltage 18...36 VDC smoothed
I +	Current signal 4...20 mA – selected measured signal
RS 485 (A) RS 485 (B)	Modbus RTU A Modbus RTU A

Pulse	Pulse for consumption
NC	Must not be connected to a voltage and/or to protection earth. Please cut and isolate cables.

If no connection cable/ pulse cable is ordered the sensor will be supplied with a M12 connector plug. The user can connect the supply and signal cables as indicated in the connection diagram.

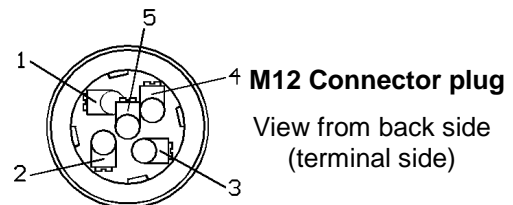

Connector plug A (M12 - A-coding)

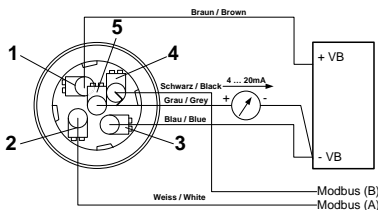

Connector plug B (M12 - A-coding)

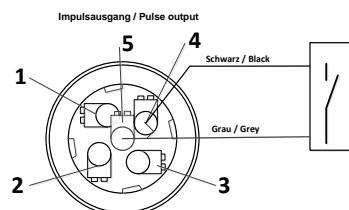

Remark: If the sensor is placed at the end of the Modbus system a termination is required. The sensors have an internal switchable termination, therefore the 6 fastening screws from the lid are to be released and set the internal DIP Switch to "On". It must be ensured that the connection plugs are still plugged and the gasket is installed correctly.

Alternatively, a 120R resistor can be installed in the plug between pin 2 and pin 4.

8 Operation

Remark: The display for the Type 8007 is optional and not included by default in delivery.

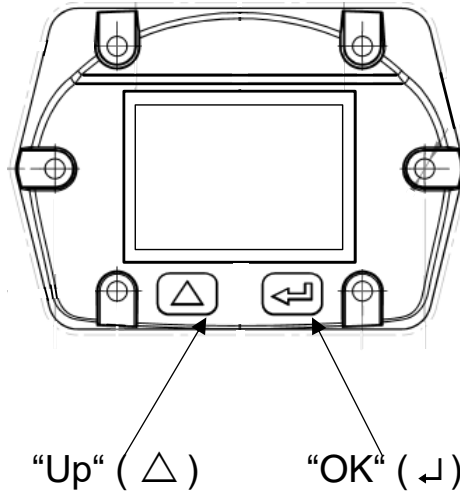

The operation of the Typ 8007 is done by the two capacitive key buttons Up (\triangle) und Enter (\leftarrow)

8.1 Initialization

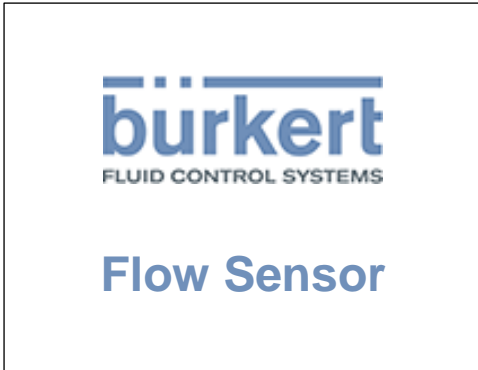

After switching on the Typ 8007 the initialized screen is displayed followed by the main menu.

8.2 Main menu

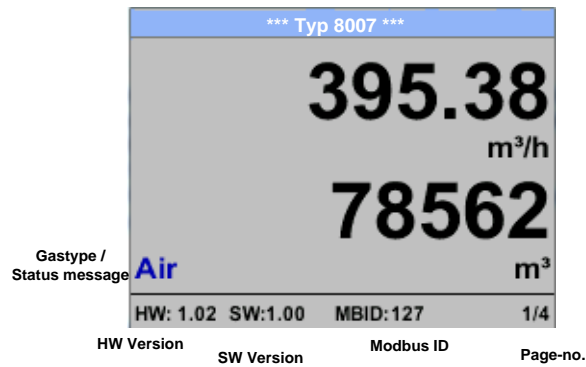

Switching to pages 2-4 or back by pressing key „△“

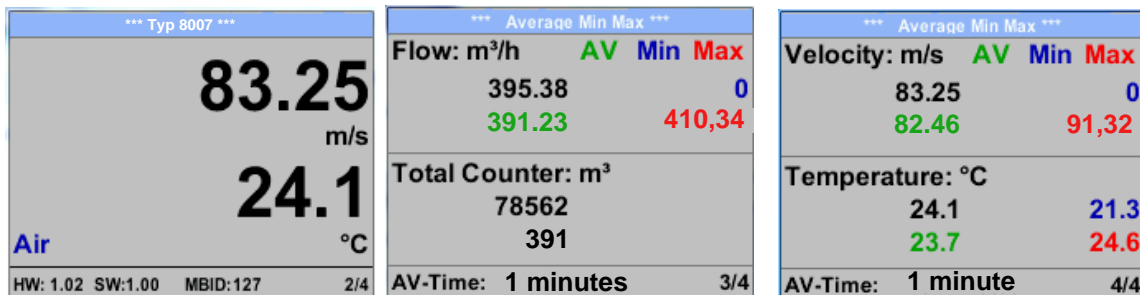

AV-Time (Period for average value calculation) could be changed under [Sensor Setup.-Advanced- AV-Time](#)

8.3 Settings

The settings menu could accessed by pressing the key „OK“.
But the access to the *settings menu* is password protected.



Factory settings for password at the time of delivery: 0000 (4 times zero).

If required the password could be changed at *Setup-User setup-Password*.

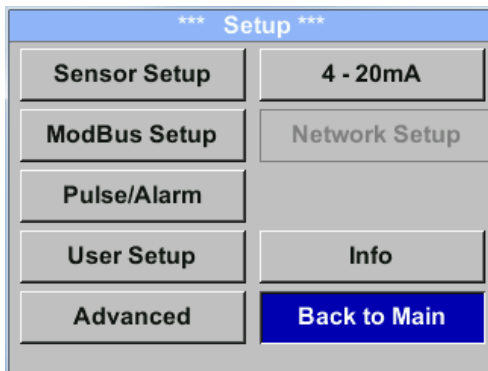

Selection of a menu item or to change a value is done with the key „ Δ “, a final move to the chosen menu item or takeover of the value change needs the confirmation by pressing the key „OK“

8.3.1 Sensor Setup

Setup → Sensor Setup

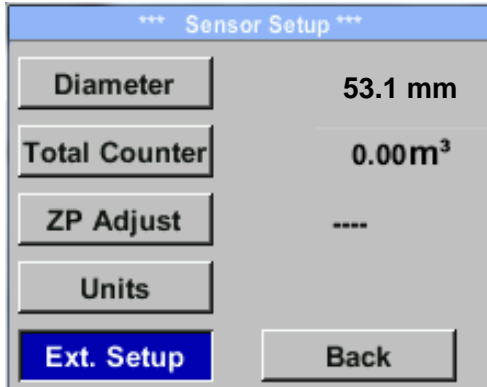

For changes, first select the menu item with key „ Δ “ and then confirm it with **“OK”**.

8.3.1.1 Input / change tube diameter

Settings → Sensor Setup → Diameter

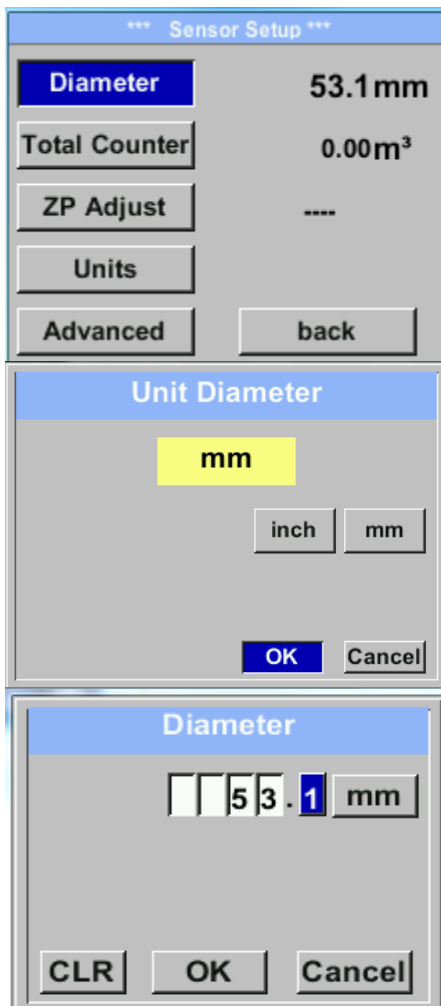

In order to change, e.g. the unit, first select by pressing key „ Δ “ the field **“Units”** and then key **“OK”**.

Select with the key „ Δ “ the correct unit and then confirm selection by pressing 2x **„OK”**.

Entering / changing the diameter via button „ Δ “, select the respective position and activate the position with the **“OK”** button.

By pressing „ Δ “ the position value is incremented by 1. Complete with **“OK”** and activate next number position. Confirm entry by pressing **„OK”**.

8.3.1.2 Input / change consumption counter

Setup → Sensor Setup → Total Counter → Unit button

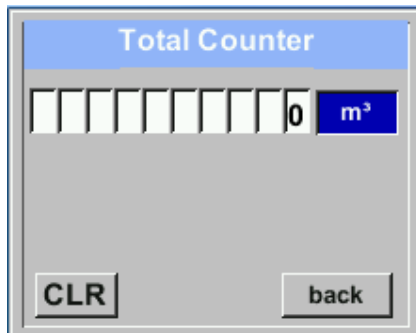
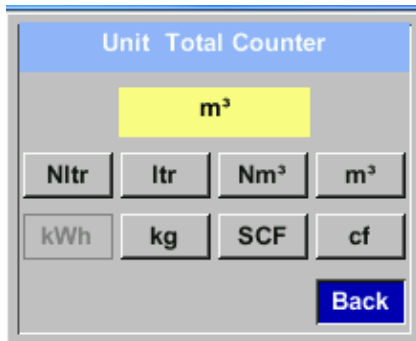

In order to change, e.g. the unit, first select by pressing key „ Δ “ the button **“Unit”** and then key **“OK”**.

Select with the key „ Δ “ the correct unit and then confirm selection by pressing 2x **„OK“**.

Entering / changing the consumption counter via button „ Δ “, select the respective position and activate the position with the **“OK”** button.

By pressing „ Δ “ the position value is incremented by 1. Complete with **“OK”** and activate next number position.

Confirm entry by pressing **„OK“**.

Important!

When the counter reach 10000000 m³ the counter will be reset to zero.

8.3.1.3 Definition of the units for flow, velocity, temperature and pressure

Setup → Sensor Setup → Units

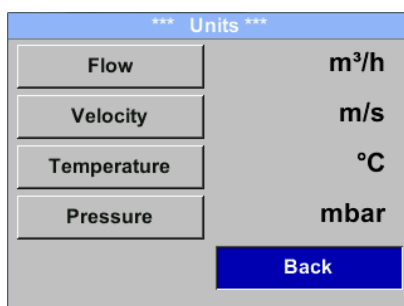

To make changes to the unit for the respective measurement value, first select by pressing „ Δ “ the field of the „measurement value“ and activate „it with **„OK“**.

Selection of the new unit with „ Δ “

In case the quantity of units selectable are not presentable on one page, pleas move to next page by pressing „ \ll “.

Confirm selection by pressing 2x **„OK“**.

Procedure for all 4 measurement variables is analogous.

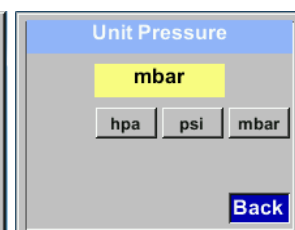
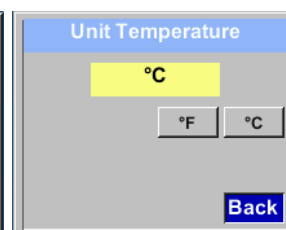
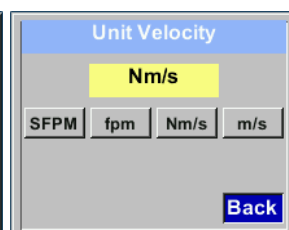
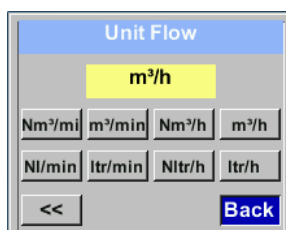

8.3.1.4 Definition of the reference conditions

Here can be defined the desired measured media reference conditions for pressure and temperature and times for the filter and averaging.

- Factory presetting for reference temperature and reference pressure are 20 °C, 1000 hPa
- All volume flow values (m³/h) and consumption values indicated in the display are related to 20 °C and 1000 hPa (according to ISO 1217 intake condition)
- Alternatively 0 °C and 1013 hPa (=standard cubic meter) can also be entered as a reference.
- **Do not enter the operation pressure or the operation temperature under reference conditions!**

Setup → Sensor Setup → Advanced

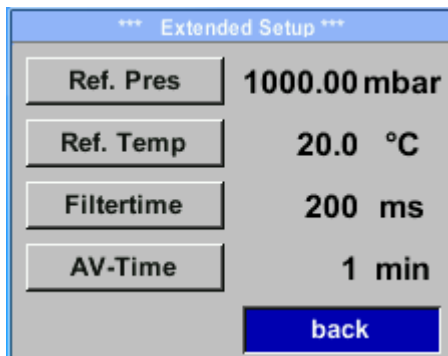

To make changes, first select a menu with button „Δ“ and confirm selection by pressing „OK“ .

Setup → Sensor Setup → Advanced → Ref.Pref



In order to change, e.g. the unit, first select by pressing key „Δ“ the field **“Units”** and then key **“OK”**.

Select with the key „Δ“ the correct unit and then confirm selection by pressing 2x **„OK“**.

Input / change of the value by selecting the respective position with button „Δ“ and entering by pressing button **„OK“** .

Setup → Sensor Setup → Advanced → Ref.Temp

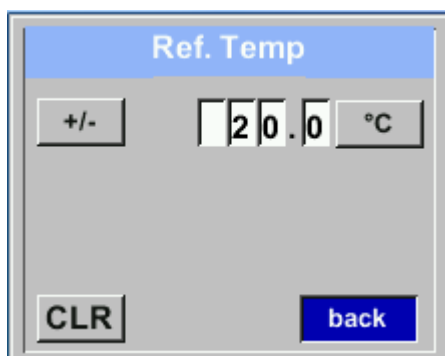

By pressing „Δ“ the position value is incremented by 1. Complete with **“OK”** and activate next number position.

Procedure for changing the reference temperature is the same.

Setup → Sensor Setup → Advanced → *Filtertime*

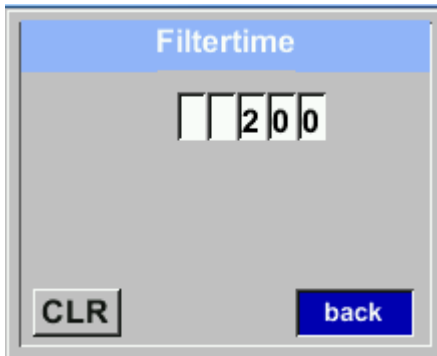

Under item "*Filtertime*" an attenuation can be defined.
Input values of 0 -10000 in [ms] are possible

Setup → Sensor Setup → Advanced → *AV-Time*

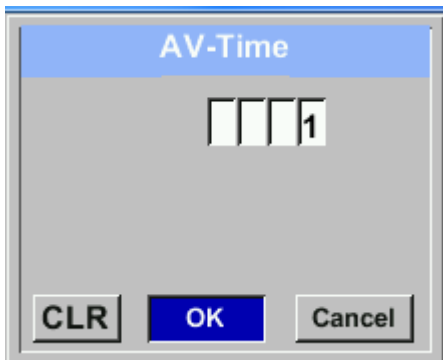

The time period for averaging can be entered here.
Input values of 1-1440 [minutes] are possible.
For average values see display window 3 + 4

8.3.1.5 Setting of Zeropoint and Low-flow cut off

Setup → Sensor Setup → ZP Adjust

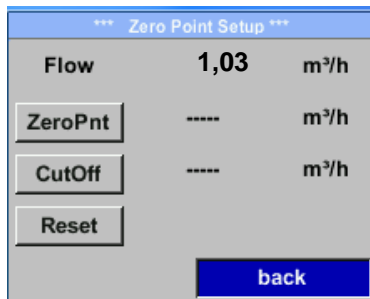

To make changes, first select a menu with button „ Δ “ and confirm selection by pressing „OK“.

Setup → Sensor Setup → ZP Adjust → ZeroPnt

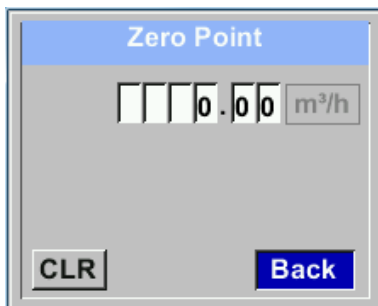

When, without flow, the installed sensor shows already a flow value of > 0 m³/h herewith the zero point of the characteristic could be reset.

For an input / change of the value select with the button „ Δ “ the respective number position and activate it with „OK“.

By pressing „ Δ “ the position value is incremented by 1. Confirm the input with „OK“ and activate next number position.

Leave menu with button „Back“

Setup → Sensor Setup → ZP Adjust → CutOff

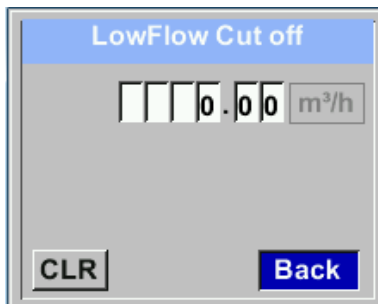

With the low-flow cut off activated, the flow below the defined "LowFlow Cut off" value will be displayed as 0 m³/h and not added to the consumption counter.

For an input / change of the value select with the button „ Δ “ the respective number position and activate it with „OK“.

By pressing „ Δ “ the position value is incremented by 1. Confirm the input with „OK“ and activate next number position.

Leave menu with button „Back“

Setup → Sensor Setup → ZP Adjust t → Reset

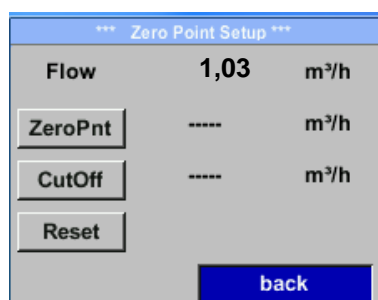

By selection of „Reset“ all settings for „ZeroPnt“ and „CutOff“ are reset.

Menu item to be select with button „ Δ “ and confirm the reset with „OK“.

Leave menu with button „Back“

8.3.2 Modbus Setup

The Flow sensors Typ 8007 comes with a Modbus RTU Interface. Before commissioning the sensor the communication parameters

- Modbus ID, Baudrate, Parity und Stop bit

must be set in order to ensure the communication with the Modbus master.

Settings → Modbus Setup

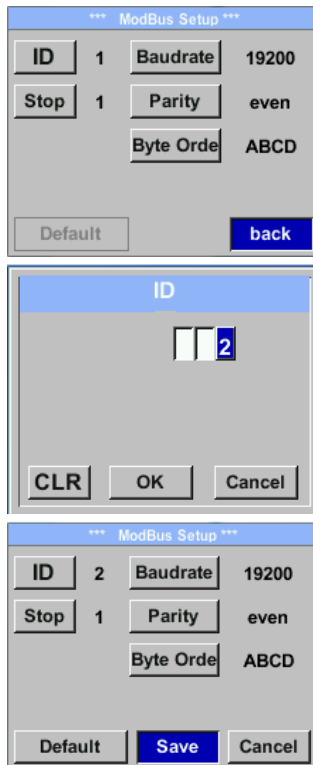

For changes, e.g. the sensor ID, first select by pressing key „Δ“ the field “ID” and then key “OK”.

Select the desired position by pressing the “>” and select with “OK” button.

Change values by pressing the „Δ“ values takeover by pressing “OK”.

Inputs for baudrate, stopbit and parity is done analogue.

By means of the button "Byte Order" it is possible to change the data format (Word Order). Possible formats are "ABCD" (Little Endian) and "CDAB" (Middle Endian)

Saving the changes by pressing “Save”, therefore select it with key „Δ“ and then confirm it with “OK”.

Default values out of factory:

Modbus ID:	1
Baud rate:	19200
Stopbit:	1
Parity:	even
Byte Order:	ABCD
Byte Order:	ABCD

Remark: If the sensor is placed at the end of the Modbus system a termination is required. The sensors have an internal switchable termination, therefore the 6 fastening screws from the lid are to be released and set the internal DIP Switch to “On”.

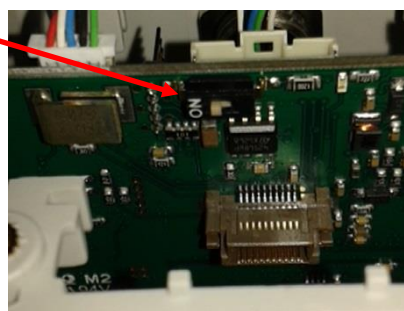
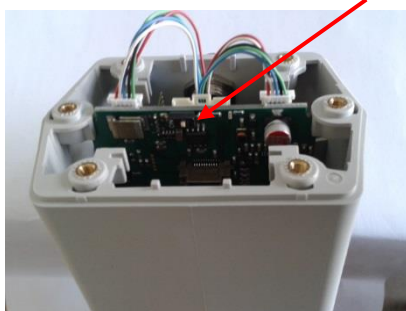

Alternatively, a 120R resistor can be installed in the plug between pin 2 and pin 4.

It must be ensured that the connection plugs are still plugged and the gasket is installed correctly, see also chapter 4.5.

8.3.2.1 Modbus Settings (2001...2005)

Modbus Register	Register Address	No. of Byte	Data Type	Description	Default Setting	Read Write	Unit /Comment
2001	2000	2	UInt16	Modbus ID	1	R/W	Modbus ID 1...247
2002	2001	2	UInt16	Baudrate	4	R/W	0 = 1200 1 = 2400 2 = 4800 3 = 9600 4 = 19200 5 = 38400
2003	2002	2	UInt16	Parity	1	R/W	0 = none 1 = even 2 = odd
2004	2003	2	UInt16	Number of Stopbits		R/W	0 = 1 Stop Bit 1 = 2 Stop Bit
2005	2004	2	UInt16	Word Order	0xABCD	R/W	0xABCD = Big Endian 0xCDAB = Middle Endian

8.3.2.2 Values Register (1001 ...1500)

Modbus Register	Register Address	No. of Byte	Data Type	Description	Default	Read Write	Unit /Comment
1101	1100	4	Float	Flow in m ³ /h		R	
1109	1108	4	Float	Flow in Nm ³ /h		R	
1117	1116	4	Float	Flow in m ³ /min		R	
1125	1124	4	Float	Flow in Nm ³ /min		R	
1133	1132	4	Float	Flow in ltr/h		R	
1141	1140	4	Float	Flow in Nltr/h		R	
1149	1148	4	Float	Flow in ltr/min		R	
1157	1156	4	Float	Flow in Nltr/min		R	
1165	1164	4	Float	Flow in ltr/s		R	
1173	1172	4	Float	Flow in Nltr/s		R	
1181	1180	4	Float	Flow in cfm		R	
1189	1188	4	Float	Flow in Ncfm		R	
1197	1196	4	Float	Flow in kg/h		R	
1205	1204	4	Float	Flow in kg/min		R	
1213	1212	4	Float	Flow in kg/s		R	
1221	1220	4	Float	Flow in kW		R	

MAN 1000539696 EN Version: - Status: RL (released | freigegeben) printed: 09.03.2026

Modbus Register	Register Address	No.of Byte	Data Type	Description	Default	Read Write	Unit /Comment
1269	1268	4	UInt32	Consumption m ³ before comma	x	R	
1275	1274	4	UInt32	Consumption Nm ³ before comma	x	R	
1281	1280	4	UInt32	Consumption ltr before comma	x	R	
1287	1286	4	UInt32	Consumption Nltr before comma	x	R	
1293	1292	4	UInt32	Consumption cf before comma	x	R	
1299	1298	4	UInt32	Consumption Ncf before comma	x	R	
1305	1304	4	UInt32	Consumption kg before comma	x	R	
1311	1310	4	UInt32	Consumption kWh before comma	x	R	
1347	1346	4	Float	Velocity m/s			
1355	1354	4	Float	Velocity Nm/s			
1363	1362	4	Float	Velocity Ft/min			
1371	1370	4	Float	Velocity NFt/min			
1419	1418	4	Float	GasTemp °C			
1427	1426	4	Float	GasTemp °F			

MAN 1000539696 EN Version: - Status: RL (released | freigegeben) printed: 09.03.2026

8.3.3 Pulse / Alarm

Setup → Sensor Setup → Pulse/ Alarm

Relay Mode:	Alarm	
Unit	°C	
Value	20.0	
Hyst.	5.0	
Hi-Lim.	OK	Cancel

*** Pulse / Alarm ***		
Relay Mode:	Alarm	
Unit:	°C	
Value	20.0	
Hyst.	5.0	
Hi-Lim.	OK	Cancel

*** Pulse / Alarm ***		
Relay Mode:	Pulse	
Unit:	m ³	
Value	0.1	
Polarity	pos.	
Pls per second at max Speed:	0	Back

The galvanically isolated output can be defined as pulse- or alarm output.

Selection of field „**Relay Mode**“ with key „**Δ**“ and change modus by pressing key „**OK**“.

For alarm output following units could be chosen: kg/min, cfm, ltr/s, m³/h, m/s, °F, °C and kg/s.

„**Value**“ defines the Alarm value, „**Hyst.**“ defines the desired hysteresis and with „**Hi-Lim**“ or „**Lo-Lim**“ the alarm settings when the alarm is activated

Hi-Lim: Value over limit

Lo-Lim: Value under limit

For the pulse output following units could be chosen: kg, cf, ltr and m³. The pulse value definition to be done in menu „**Value**“. Lowest value is depending on max. flow of sensor and the max frequency of pulse output of 50Hz.

With „**Polarity**“ the switching state could be defined. Pos. = 0 → 1 neg. 1 → 0

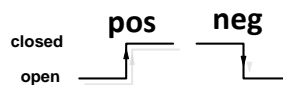

8.3.3.1 Pulse output

The maximum frequency for pulse output is 50 pulses per second (50Hz).

The Pulse output is delayed by 1 second.

Pulse value	[m ³ /h]	[m ³ /min]	[l/min]
0.1 ltr / Pulse	18	0,3	300
1ltr / Pulse	180	3	3000
0.1m ³ / Pulse	18000	300	300000
1 m ³ / Pulse	180000	3000	3000000

Table 1 Maximum flow for pulse output

Entering pulse values that are not allow a presentation to the full scale value, are not allowed. Entries are discarded and error message displayed.

8.3.4 User Setup

8.3.4.1 Password

Settings → UserSetup → Password

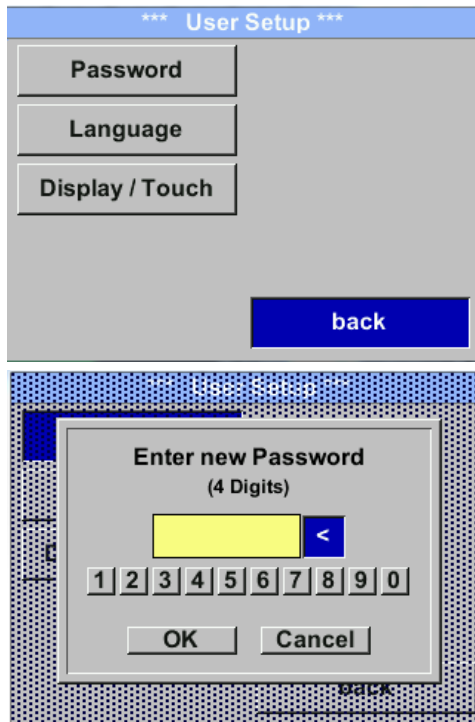

To make changes, first select a menu with button „ Δ “ and confirm selection by pressing „OK“.

It is possible to define a password. The required password length is 4 digits. Please select with button „ Δ “ a figure and confirm it with „OK“. Repeat this 4 times.

With „ Δ “ the last figure could be deleted. Password input have to be inserted twice.

Confirmation of input/password by pressing „OK“.

Factory settings for password at the time of delivery: 0000 (4 times zero).

8.3.4.2 Language

Settings → UserSetup → Language

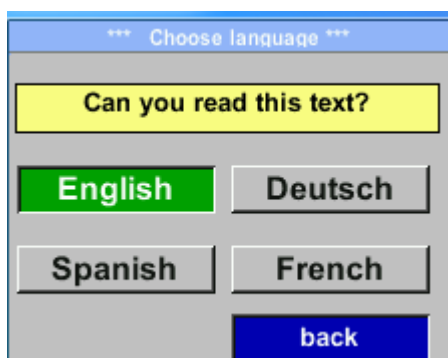

Currently 4 languages have been implemented and could be selected with button „ Δ “.

Change of language by confirming with “OK”. Leaving the menu with button “back”.

8.3.4.3 Display / Touch

Settings → UserSetup → Display / Touch

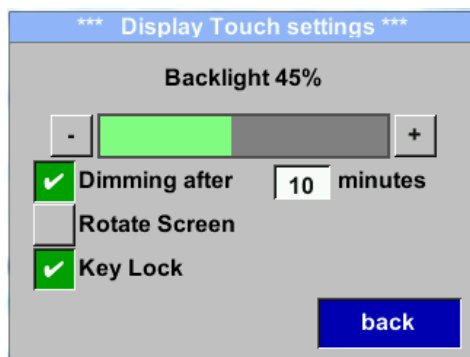
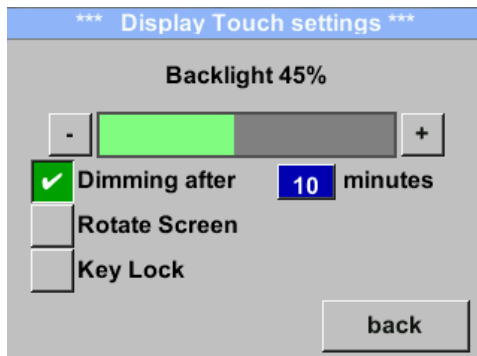

With the button „-“ and with button „+“ it is possible to adjust the backlight / display brightness. The actual / adjusted backlight brightness is shown in the graph „**Backlight.**“

By activation **“Dimming after”** and entering a time a display dimming could be set.

With **„Rotate Screen“** the display information could be rotated by 180°.

By activation of **„Key Lock“** the operation of the sensor locked.

Unlocking the keyboard is only possible by restarting the sensor and calling the operating menu within the first 10s. To do this, use the **“OK”** button to enter the operating menu during this period

8.3.5 Advanced

Settings → Advanced

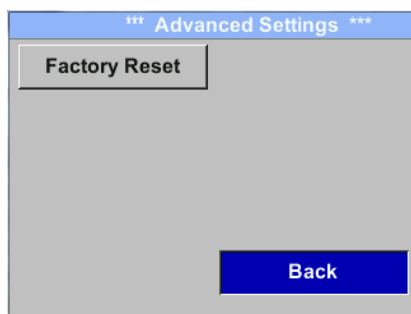

By pressing **„Factory Reset“** the sensor is set back to the factory settings.

8.3.6 4 -20mA

Settings → 4-20mA

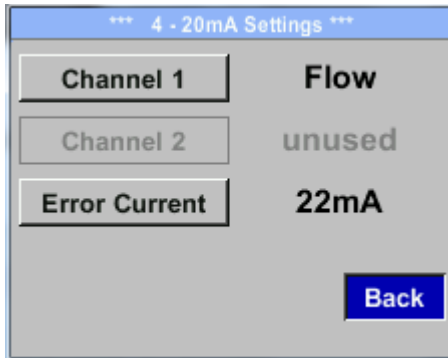

To make changes, first select a menu with button „**Δ**“ and confirm selection by pressing „**OK**“.

Settings → 4-20mA → Channel 1

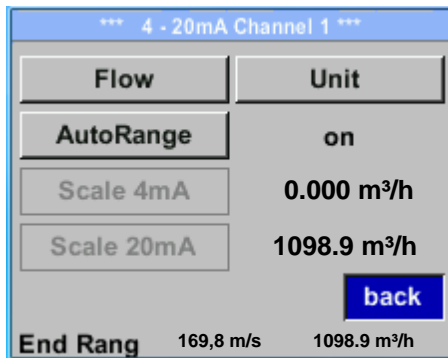

The 4-20 mA Analogue output of the Sensor Typ 8007 can be individually adjusted.

It is possible to assign following values „**Temperature**“, „**Velocity**“ und „**Flow**“ to the channel CH 1.

To make changes, first select the value item with button „**Δ**“ .and confirm

Moving between the different measurements values or to deactivate the 4-20mA with setting to „**unused**“ by pressing „**OK**“.

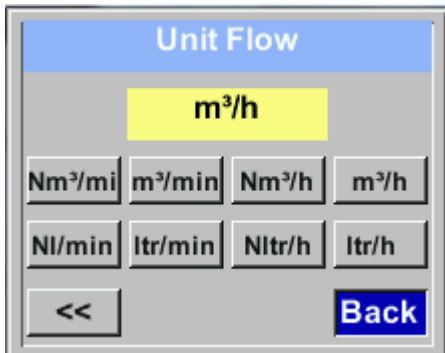

To the selected measurement value a corresponding / appropriate unit needs to be defined. Select „**Unit**“ with „**Δ**“ and open menu with „**OK**“.

Select required unit with „**Δ**“ and take over by pressing „**OK**“.

Here e.g. for the measurement value Flow, procedure for the other measurements values is analog.

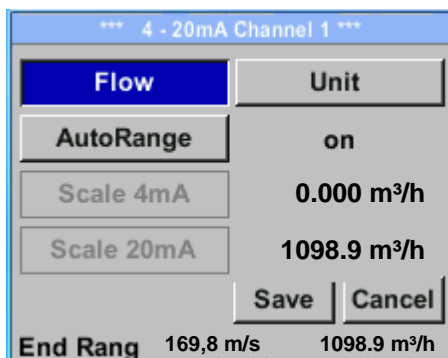

For saving the changes done press button „**Save**“ to discard the changes press button „**Cancel**“.

Leaving the menu with „**Back**“.

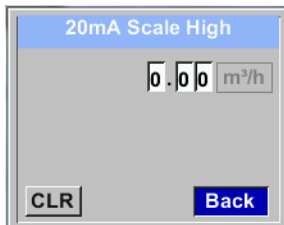
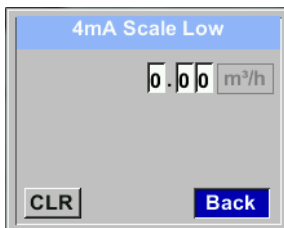
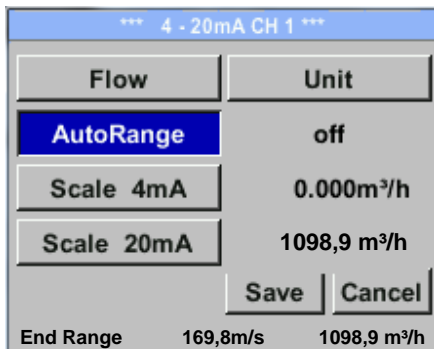

The scaling of the 4-20mA channel can be done automatically "Auto Range = on" or manual "AutoRange = off" .

With button „**Δ**“ select the menu item „AutoRange“ select with „**OK**“ the desired scaling method. (Automatically or manually)

In case of **AutoRange = off** with „**Scale 4mA**“ und „**Scale 20mA**“ the scale ranges needs to be defined.

Select with button „**Δ**“ the item „Scale 4mA“ or „Scale 20mA“ and confirm with „**OK**“ .

Input of the scaling values will be analogous as described before for value settings.

Using „**CLR**“ clears up the complete settings at once.

For „**Auto on**“ , the max. scaling is calculated based on the inner tube diameter, max. measurement range and the reference conditions settings.

Take over of the inputs with „**Save**“ and leaving the menu with „**Back**“.

Settings → 4-20mA → Error Current

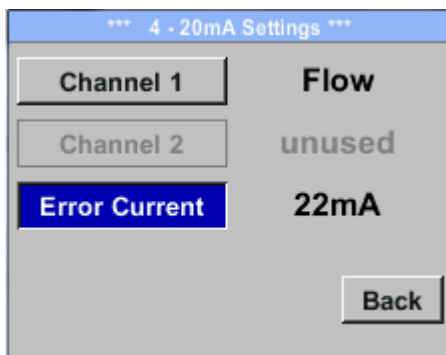

This determines what is output in case of an error at the analog output.

- 2 mA Sensor error / System error
- 22 mA Sensor error / System error
- None Output according Namur (3.8mA – 20.5 mA)
< 4mA to 3.8 mA Measuring range under range
>20mA to 20.5 mA Measuring range exceeding

To make changes first select a menu item "Current Error" with button „**Δ**“ and then select by pressing the „**OK**“ the desired mode

For saving the changes done press button „**Save**“ to discard the changes press button „**Cancel**“.

Leaving the menu with „**Back**“.

8.3.7 Typ 8007 Info

Setup → Sensor Setup → Info

*** Info ***	
Production Datas	
Serial No.:1234567890	Details
Cal. Date: 10.01.2013	
Sensor Datas	
Sensor Type: IST 1.8	
Max Speed: 92,7 m/s 600m³/h	
Max Temp: 100.0 °C	
Live Datas	
Run Time: 2d 21h 23m 12s	
Vin: 23,8V	Temp: 35,8
Options	Back

*** Calibration Details ***	
Calibration Conditions	
Ref. Pressure:	1000.00mbar
Ref. Temperature:	20 °C
Cal. Diameter:	53,1 mm
Cal. Pressure:	6000.00mbar
Cal. Temperature:	23 °C
Cal. Points:	10
Back	

Here you get a brief description of the sensor data incl. the calibration data.

Under **Details**, you are able to see in addition the calibration conditions.

9 Status / Error messages

9.1 Status messages

- **CAL**

On the part of Bürkert Werke GmbH a regular re-calibration is recommended, see chapter 13. At delivery, the date at which the next recalibration is recommended is internally entered. When this date is reached, a message appears in the display with the status message „**CAL**“.

Note: The measurement will continue without interruption or restriction.

- **Direction**

When used in conjunction with a direction switch VA409, the status message "Direction" is displayed in case of opposite flow direction and no measurement may take place.

Status messages:

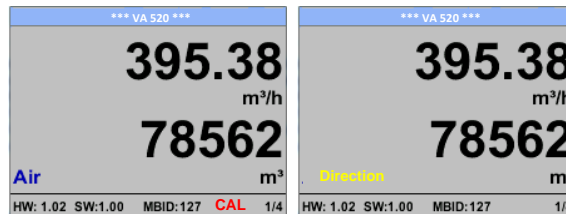

9.2 Error messages

- **Low Voltage**

If the supply voltage is less than 11V, the warning message „**Low Voltage**“ is displayed. This means that the sensor can no longer work / measure correctly and thus there are none measured values for flow, consumption and speed are available.

- **Heater Error**

The error message „**Heater Error**“ occurs in case of failure of the heating sensor.

- **Internal Error**

In the case of this message „**Internal Error**“, the sensor has an internal read error on e.g. EEPROM, AD converter etc. detected.

- **Temp out of Range**

At media temperatures outside the specified temperature range, the status message „**Temp out of Range**“ occurs.

This temperature overshoot leads to incorrect measurement values (outside the sensor specification).

- **Low Voltage 4-20mA**

For sensors with a galvanically isolated 4-20mA output, a min. Supply voltage of 17.5V is required. If this value is undershot, the error message „**Low Voltage 4-20mA**“ is displayed.

Error messages:

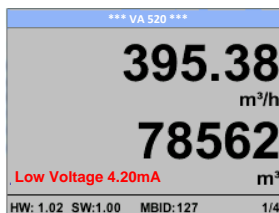
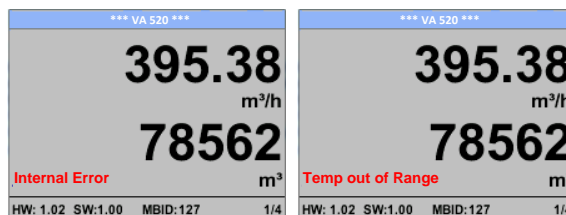
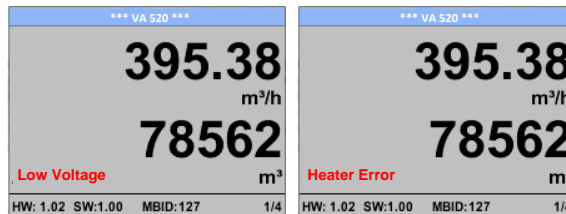

10 Maintenance

The sensor head should be checked regularly for dirt and cleaned if necessary. Should dirt, dust or oil accumulate on the sensor element, a deviation will occur in the measuring value. An annual check is recommended. Should the compressed air be heavily soiled this interval must be shortened.

11 Cleaning of the sensor head

The sensor head can be cleaned by carefully moving it back and forth in warm water with a small amount of washing-up liquid. Avoid physical intervention on the sensor (e.g. using a sponge or brush). If soiling cannot be removed, the manufacturer must carry out service and maintenance.

12 Re-Calibration

If no customer specifications are given then we recommend carrying out calibration every 12 months. For this purpose, the sensor must be sent to the manufacturer, Bürkert Werke GmbH.

Bürkert Werke GmbH
Christian-Bürkert-Str. 13-17
D-74653 Ingelfingen

13 Spare parts and repair

For reasons of measuring accuracy spare parts are not available. If parts are faulty, they must be sent to the supplier for repair.

If the measuring device is used in important company installations, we recommend keeping a spare measuring system ready.

14 Calibration

According to DIN ISO certification of the measuring instruments we recommend to calibrate and if applicable to adjust the instruments regularly from the manufacturer. The calibration intervals should comply with your internal specification. According to DIN ISO we recommend a calibration interval of one year for the instrument Typ 8007.

On request and additional payment, calibration-certificates could be issued. The precision is given due to use DKD-certified flow meters and verifiable

15 Warranty

If you have reason for complaint, we will of course repair any faults free of charge if it can be proven that they are manufacturing faults. The fault should be reported immediately after it has been found and within the warranty time guaranteed by us. Excluded from this warranty is damage caused by improper use and non-adherence to the instruction manual.

The warranty is also cancelled once the instrument has been opened - as far as this has not been mentioned in the instruction manual for maintenance purposes - or if the serial number in the instrument has been changed, damaged or removed.

The warranty time for the Typ 8007 is 12 months. If no other definitions are given the accessory parts have a warranty time of 6 months. Warranty services do not extend the warranty time.

If in addition to the warranty service necessary repairs, adjustments or similar are carried out the warranty services are free of charge but there is a charge for other services such as transport and packaging costs. Other claims, especially those for damage occurring outside the instrument, are not included unless responsibility is legally binding.

After sales service after the warranty time has elapsed

We are of course there for you even after the warranty time has elapsed. In case of malfunctions, please send us the instrument with a short-form description of the fault. Please do not forget to indicate your telephone number so that we can call you in case of any questions.

Deliveryaddress:

Bürkert Werke GmbH
Christian-Bürkert-Str. 13-17
D-74653 Ingelfingen