

Tyyppi 2100

Paineilmaohjattu 2/2-tie-vinoistukkaventtiili
ELEMENT hajautettuun automaatioon



Operating Instructions

Oikeus teknisiin muutoksiin pidätetään.

© Bürkert Werke GmbH & Co. KG 2008-2025

Technical documentation 2511/13_Fifi_00805596_797988619_18014399307507723 / Original DE

Table of contents

1	About this document	5
1.1	Symbols	5
1.2	Terms and abbreviations	6
1.3	Manufacturer	6
2	Safety	7
2.1	Intended use	7
2.2	Safety instructions	7
3	Product description	11
3.1	Product overview	11
3.2	Product identification	13
3.2.1	Type label	13
3.2.2	Icons and labelling on the device	13
3.2.3	Determination of actuator size	13
3.3	Principle of operation	14
3.3.1	Control function	14
3.3.2	Flow direction below the seat	15
3.3.3	Flow direction above the seat	15
4	Technical data	16
4.1	Standards and directives	16
4.2	Operating conditions	16
4.3	Medium data	17
4.3.1	Application limits for ambient temperature and medium temperature	17
4.3.2	Application limits for medium temperature and operating pressure	18
4.3.3	Pressure ranges for 2/2-way valve	19
4.3.4	Pressure ranges for 2/3-way valve	26
4.3.5	Volume flow values, 2/3-way valve	29
4.4	Mechanical data	32
5	Installation	34
5.1	Connect the device to pipeline	34
5.2	Remove the actuator from the valve body	35
5.2.1	Dismantling the actuator on devices without a mounted control unit	36
5.2.2	Dismantling the actuator on devices with mounted control unit	36
5.3	Install the actuator on the valve body	37
5.4	Installing the control unit	39
5.5	Turn the actuator	39
6	Pneumatic connection	40
6.1	Connect the device pneumatically	40
7	Commissioning	42
7.1	Commission the device	42
7.1.1	Flow direction below the seat	42
7.1.2	Flow direction above the seat	42
7.2	Set the middle position on 3-position actuator	43
8	Maintenance	45
8.1	Control	45

8.2	Cleaning	45
9	Troubleshooting	46
9.1	Actuator does not switch	46
9.2	Valve is not tight	46
9.3	Valve is leaking on the relief bore	46
10	Uninstallation	47
10.1	Disassemble the device	47
11	Spare parts and accessories	48
11.1	Ordering spare parts	48
11.2	Accessories	48
11.2.1	Installation tool for packing gland	48
12	Logistics	49
12.1	Transport and storage	49
12.2	Disposal	49

1 About this document

The document is an important part of the product and guides the user to safe installation and operation. The information and instructions in this document are binding for the use of the product.

- ▶ Before using the product for the first time, read and observe the whole safety chapter.
- ▶ Before starting any work on the product, read and observe the respective sections of the document.
- ▶ Keep the document available for reference and give it to the next user.
- ▶ Contact the Bürkert sales office for any questions.



Further information concerning the product at [Products](#).

- ▶ Enter the article number from the type label in the search bar.

The illustrations in these instructions may vary depending on the product variant.

1.1 Symbols



VAARA

Warns of a danger that leads to death or serious injuries.



VAROITUS!

Warns of a danger that can lead to death or serious injuries.



HUOMIO!

Warns of a danger that can lead to minor injuries.

HUOMAUTUS!

Warns of property damage on the product or the installation.



Indicates important additional information, tips and recommendations.



Refers to information in this document or in other documents.

- ▶ Indicates a step to be carried out.

✓ Indicates a result.

Menu Indicates a software user-interface text.

1.2 Terms and abbreviations

The terms and abbreviations are used in this document to refer to following definitions.

Device	Angle seat valve Type 2100
Ex area	Potentially explosive atmosphere
Ex approval	Approval for potentially explosive atmosphere
bar	Unit for relative pressure

1.3 Manufacturer

Bürkert Fluid Control Systems

Christian-Bürkert-Str. 13-17

74653 Ingelfingen

GERMANY

The contact addresses are available at [Contact](#).



Need more information or additional products?

► Explore the full range of products on our [eShop](#).

2 Safety

2.1 Intended use

The device is designed to control the flow of media. The permissible media are listed in chapter [Technical data \[▶ 16\]](#)

Prerequisites for safe and trouble-free operation are proper transport, storage, installation, commissioning, operation and maintenance.

The instructions are part of the device. The device is intended exclusively for use within the scope of these instructions. Uses of the device that are not described in these instructions, the contractual documents or the type label can lead to severe personal injury or death, damage to the device or property and dangers for the surrounding area or the environment.

- ▶ Only trained and qualified personnel may install, operate and maintain the device. See qualification of persons in [Safety instructions \[▶ 7\]](#)
- ▶ Use the device only when it is in perfect condition.
- ▶ Use the device only in conjunction with third-party devices and components recommended and authorized by Bürkert.
- ▶ Only use devices that are approved for this type of potentially explosive atmosphere. These devices are labelled with the ATEX label on the type label. When using, always observe the details on the type label and the instructions for the potentially explosive atmosphere included in the scope of delivery for the device.
- ▶ Protect the device from environmental influences (e.g. radiation, humidity, vapours).
- ▶ Do not use the device for liquid media if the flow direction is above the seat.

2.2 Safety instructions

Qualification of personnel working with the device

Improper use of the device can lead to serious personal injury or death. To avoid accidents when working with the device, the following minimum requirements must be met:

- ▶ Carry out work on the device within the scope of these instructions in a safety-compliant manner.
- ▶ Detect and avoid dangers when working on the device.
- ▶ Understand the instructions and implement the information contained therein accordingly.

Responsibility of the operator

The operator is responsible for observing the location-specific safety regulations, also in relation to personnel.

- ▶ Observe the general rules of technology.
- ▶ Install the device according to the regulations applicable in the respective country.
- ▶ The operator must make hazards arising from the location of the device avoidable by providing appropriate operating instructions.

Changes and other modifications, spare parts and accessories

Changes to the device, incorrect installation or use of non-approved devices or components create hazards that can lead to accidents and injuries.

- ▶ Do not make any changes to the device.
- ▶ Do not mechanically load the device.
- ▶ Observe the operating instructions of the device or component used.
- ▶ Only use the devices in conjunction with devices and components recommended or approved by Bürkert.

Spare parts and accessories that do not meet Bürkert's requirements may impair the operational safety of the device and cause accidents.

- ▶ To ensure operational safety, only use original parts from Bürkert.

Operation only after proper transport, storage, installation, start-up or maintenance.

Improper transport, storage, installation, start-up or maintenance endanger the operational safety of the device and can cause accidents. This can lead to serious personal injury or death.

- ▶ Only carry out works which are described in these instructions.
- ▶ Only carry out works using suitable tools.
- ▶ Have all other works carried out by Bürkert only.

Heavy device

During transportation or installation works, heavy devices may fall and cause injuries.

- ▶ Secure heavy device to keep it from tipping or falling over.
- ▶ If necessary, only transport, install and uninstall heavy device with the help of a second person.
- ▶ Use suitable tools.

Technical limit values and media

Non-compliance with technical limit values or unsuitable media can damage the device and lead to leaks. This can cause accidents and seriously injure or kill people.

- ▶ Comply with limit values. See [Technical data \[▶ 16\]](#) and information on the type label.
- ▶ Only feed media into the media ports that are listed in the chapter [Technical data \[▶ 16\]](#).
- ▶ Observe the safety data sheet for the media used.

Only use authorised devices in potentially explosive atmospheres

Devices that may be used in potentially explosive atmospheres are labelled with an Ex marking. Additional instructions with Ex labelling are included with these devices.

- ▶ Only use devices that are approved for use in a potentially explosive atmosphere.
- ▶ For use in potentially explosive atmospheres, observe the information on the device.
- ▶ For use in potentially explosive atmospheres, observe the additional instructions with Ex labelling.
- ▶ Do not use devices that do not have this Ex labelling and additional instructions in potentially explosive atmospheres under any circumstances.

Medium under pressure

Medium under pressure can seriously injure people. In the event of overpressure or pressure surges, the device or lines can burst. Pneumatic lines that are defective or not securely fastened can come loose and swing around.

- ▶ Before working on the device or system, switch off the pressure. Vent or empty the lines.
- ▶ Adhere to the permitted pressure ranges of the medium.
- ▶ Comply with the permitted temperature ranges of the medium.

Contaminated pilot air

The control exhaust air of the device can be contaminated with lubricants and damage the health of people and the environment.

- ▶ Dissipate control exhaust air appropriately.
- ▶ Wear appropriate personal protective equipment when working near the device.

If exhaust air from other processes is used to generate compressed air for the device, seals may be destroyed by the media contained in the exhaust air and cause medium to escape.

- ▶ Only use fresh air for generating compressed air for the device.

Hot surfaces and fire hazard

The surface of the device can become hot with fast-switching actuators or with hot media.

- ▶ Wear suitable protective gloves.
- ▶ Keep highly flammable substances and media away from the device.

Electric shock due to electrical components

Touching live parts can result in severe electric shock. This can lead to serious personal injury or death.

- ▶ Before working on the device or system, switch off the power supply. Secure it against reactivation.
- ▶ Observe any applicable accident prevention and safety regulations for electrical devices.

Hearing damage due to high noise level

Depending on the operating conditions, the device may generate loud noises.

- ▶ If the noise level exceeds 75 dB(A), wear hearing protection when near the device.

Working on the device

Working on the device that has not been powered down, unauthorised switching on or uncontrolled start-up of the system can cause accidents. This can lead to serious personal injury or death.

- ▶ Only work on the device when it is not in use.
- ▶ Ensure that the device or system cannot be switched on unintentionally.
- ▶ Only start the process in a controlled manner following disruptions. Observe sequence:
 1. Apply supply voltage or pneumatic supply.
 2. Charge the device with medium.

Mechanical moving parts

- ▶ Do not reach into openings.

The actuator contains a pre-tensioned spring. If the actuator is opened, there is a risk of injury if the spring pops out.

- ▶ Do not open the actuator.
- ▶ Operate 3-position actuator with transparent cap only.

Danger from wear and tear on device

If there is wear and tear, medium can leak out of the relief bore and people may be seriously injured.

- ▶ Relief bore must be regularly inspected for any medium leakages.
- ▶ If media are hazardous, safeguard the environment around the relief bore.

The device can become leak at the valve seat if there is wear and tear.

- ▶ Check device regularly and change the wearing parts if necessary.

3 Product description

The device is specially optimised for decentralised process automation and meets all the relevant requirements, even under difficult usage conditions.

Its design enables the easy integration of automation modules in all extension stages, whether they are electrical/optical position feedback, pneumatic control units, or even an integrated fieldbus interface. Long service life and high tightness are achieved by the tried and tested self-adjusting packing gland. The system, consisting of valve and automation module is distinguished by a compact and sleek design, integrated pilot air ducts, a high chemical resistance, the degrees of protection IP65 or IP67 as well as the NEMA protection class 4X.

The device uses neutral gases or air to control the flow rate of liquid or gaseous media, such as water, alcohol, oil, fuel, saline solution, hydraulic fluid, lye, organic solvent or vapour.

3.1 Product overview

2/2-tieventtiili

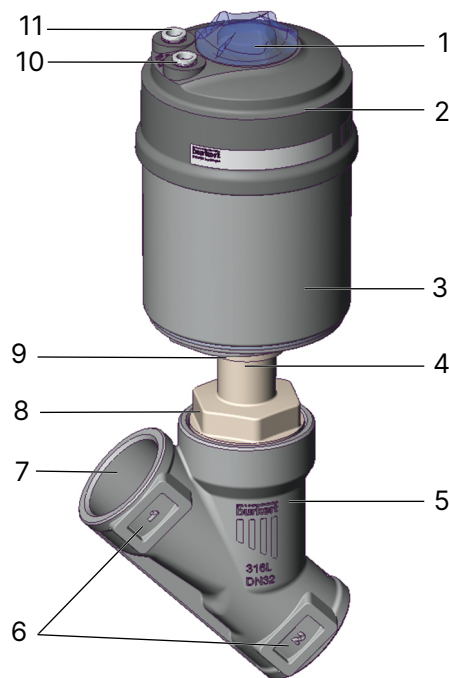

Kuva 1: Tuoterakenne, esimerkki

1 Kirkas suojakupu asennonosoittimella	2 Käyttökansi
3 Käyttökotelo	4 Relief bore
5 Venttiilikotelo	6 Flow direction marking
7 Putkiliitäntä	8 Body connection
9 Actuator connection	10 Pilot air port 1
11 Pilot air port 2	

2/3-tieventtiili



Kuva 2: Tuoterakenne, esimerkki

1 Kirkas suojakupu asennonosoittimella	2 Käyttökansi
3 Käyttökotelo	4 Relief bore
5 Venttiilikotelo	6 Flow direction marking
7 Putkiliitäntä	8 Body connection
9 Actuator connection	10 Pilot air port 1
11 Pilot air port 2	12 Nut
13 vastamutteri	

3.2 Product identification

3.2.1 Type label

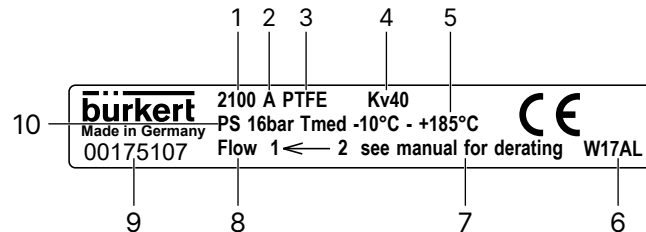

Kuva 3: Type label (example)

1 Type	2 Control function
3 Sealing material	4 Flow coefficient
5 Maximum medium temperature	6 Manufacture code
7 Derating see operating instructions	8 Flow direction
9 Article number	10 Maximum operating pressure

3.2.2 Icons and labelling on the device

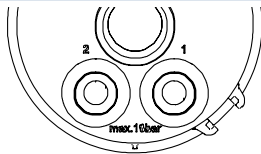

Specification of the maximum pilot pressure
1 and 2: Labelling of pilot air ports



1: Labelling of ports
2: (depending on variant): Labelling of thread
3: (both sides, depending on variant):
Company logo, DN, nominal pressure, ASME pressure level, material

3.2.3 Determination of actuator size

Scale drawing	Ø A [mm]	Actuator size
	64.5	50 (D)
	91	70 (M)
	120	90 (N)
	159	130 (P)

Taul. 1: Determination of ELEMENT actuator size

3.3 Principle of operation

The closing force is transferred by a spindle connected to the actuator piston.

Control function A (CFA)

The spring force generates the closing force on the swivel plate.

Control function A (CFA), 2/3-way valve

Middle position:

The middle position corresponds to a specific, adjustable flow rate of the medium and is set with the nut.

An additional piston is used as a stop for the actuator piston. If pilot air port 2 is pressurised, the additional piston moves downwards to the set position. If pilot air port 1 is then pressurised, the actuator piston moves upwards until it hits the additional piston and stops.

Maximum stroke:

If the upper air chamber is vented by pilot air port 2, both pistons move upwards. As a result, the maximum stroke is reached.

Close the valve:

If the lower air chamber is vented by pilot air port 1, the spring force acts on the actuator piston. The spring force moves the actuator piston downwards until the valve is closed (rest position).

Control function B and I (CFB and CFI)

The pilot pressure generates the closing force on the swivel plate.

3.3.1 Control function

Symbol	Description	
	<p>Control function A (CFA), NC Pneumatically actuated on/off valve, 2/2-way Closed by spring force in rest position Flow direction below the seat/Flow direction above the seat</p>	
	<p>Control function B (CFB), NO Pneumatically actuated on/off valve, 2/2-way Opened by spring force in rest position Flow direction below the seat</p>	
	<p>Control function I (CFI), DA Pneumatically actuated on/off valve on both sides, 2/2-way Rest position not defined (unpressurised) Flow direction below the seat/Flow direction above the seat</p>	

Taul. 2: Control function

2/3-way valve:

Symbol	Description	
	<p>Control function A (CFA), NC Pneumatically actuated on/off valve, 2/3-way Closed by spring force in rest position Flow direction below the seat/Flow direction above the seat</p>	

Taul. 3: Control function

3.3.2 Flow direction below the seat

Only use flow direction below the seat for:

- Liquid media
- Gases and vapours

As the medium is present under the swivel plate, the operating pressure contributes to the opening of the valve.

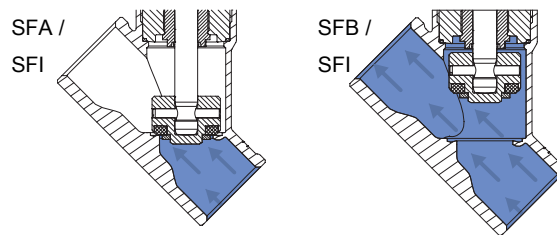

Kuva 4: Virtaus istukan alla, venttiili sulkeutuu ainevirtaa vastaan

3.3.3 Flow direction above the seat

Only use flow direction above the seat for:

- Gases and vapours
- Valves control function A (closed by spring force in rest position)¹⁾

As the medium is present above the swivel plate, the operating pressure contributes to the closing of the valve. The operating pressure also supports the sealing of the valve seat.

¹⁾ Not for seat size 80

4 Technical data

4.1 Standards and directives

This product complies with the legal requirements applicable at the time of placing on the market and has been developed and tested in accordance with the relevant European directives/regulations and harmonized standards. The conformity is documented and, if necessary, supported by evidence. The EU Declaration of Conformity can be found behind the respective type on the home page country.burkert.com

4.2 Operating conditions

Ambient temperature	See Medium data [▶ 17]
Storage temperature	-20...+65 °C
Degree of protection (EN 60529/ IEC 60529)	IP67
Altitude	Up to 2000 m above sea level
Medium temperature	See Medium data [▶ 17]
Medium	Water, alcohols, oils, fuels, hydraulic fluids, saline solutions, lyes, organic solvents, vapour, neutral gases
Operating pressure	See Medium data [▶ 17] , pressure ranges
Control medium	Neutral gases, air
Pilot pressure	See Pressure ranges
Sound pressure level	< 70 dB(A) The sound pressure level may be higher depending on the usage conditions.

4.3 Medium data

4.3.1 Application limits for ambient temperature and medium temperature

Ambient temperature and medium temperature

Pilot air port	Medium temperature for PTFE and PEEK seal [°C] ²⁾	Ambient temperature [°C] ³⁾⁴⁾
Push-in connector	-10...+230	-10...+60
Threaded bushing	-10...+230	-10...+100

Taul. 4: Ambient temperature and medium temperature

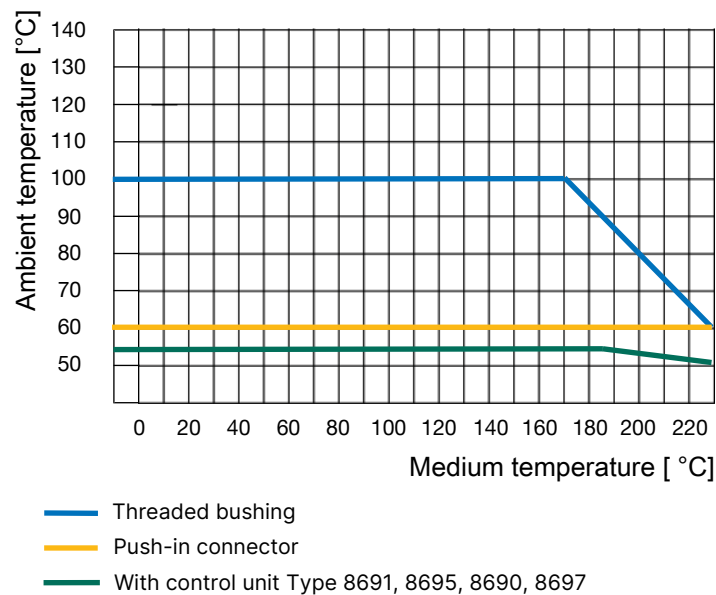

Kuva 5: Derating

MAN 1000418103 FI Version: C Status: RL (released | freigegeben) printed: 18.03.2026

2) A PEEK seal is recommended during use with $T_{max} > 130$ °C.
 3) Max. ambient temperature when using a pilot valve is +55 °C.
 4) When using an attachment, observe its temperature range.

4.3.2 Application limits for medium temperature and operating pressure

Derating the operating pressure as per DIN EN 12516-1/PN25

Temperature [°C]	Pressure (bar)
-10...+50	25.0
100	24.5
150	22.4
200	20.3
230	19.0

Derating the operating pressure as per ASME B16.5/ASME B16.34 Cl.150

Temperature [°C]	Pressure (bar)
-29...+38	19.0
50	18.4
100	16.2
150	14.8
200	13.7
230	12.7

Derating the operating pressure as per JIS B 2220 10K

Temperature [°C]	Pressure (bar)
-10...+50	14.0
100	14.0
150	13.4
200	12.4
230	11.7

MAN 1000418103 FI Version: C Status: RL (released | freigegeben) printed: 18.03.2026

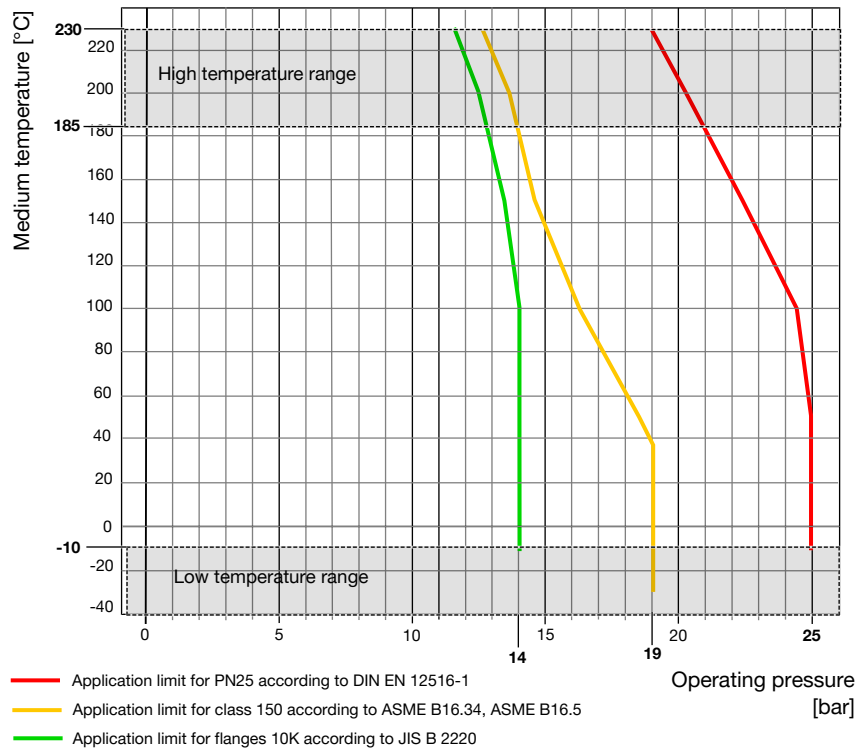

Kuva 6: Medium

4.3.3 Pressure ranges for 2/2-way valve



“Technical features” for other seal materials and variants not listed: enter the article number in the search bar at country.burkert.com and select the product.

Flow direction below seat

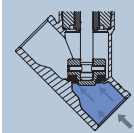

Actuator size 50 (D), flow direction below seat

Pilot pressure	max. 10 bar	
Control function A (CFA)		
Minimum control pressure	5.2 bar	
Operating pressure		
Nominal diameter	PTFE	PEEK
DN15	Max. 25 bar	Max. 25 bar
DN20	Max. 16 bar	Max. 13.5 bar
DN25	Max. 9 bar	Max. 7.5 bar
Control function B (CFB), control function I (CFI)		
Minimum control pressure	Depending on the operating pressure, see figure below	
Operating pressure	Max. 25 bar	

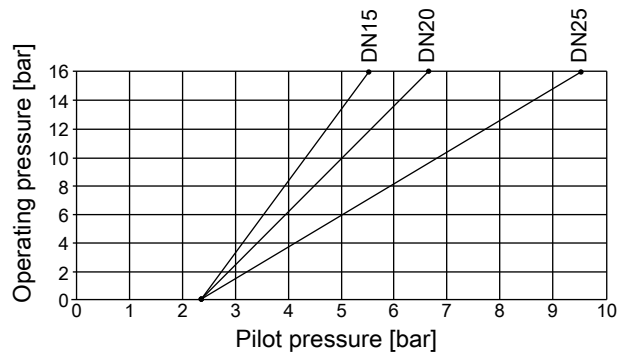

Kuva 7: Minimum control pressure, actuator size 50 (D), control function B and I

Variants with reduced spring force:

Pilot pressure	max. 10 bar
Control function A (CFA)	
Minimum control pressure	3.2 bar
Operating pressure	
Nominal diameter	PTFE
DN15	Max. 14 bar
DN20	Max. 6 bar
DN25	Max. 3 bar

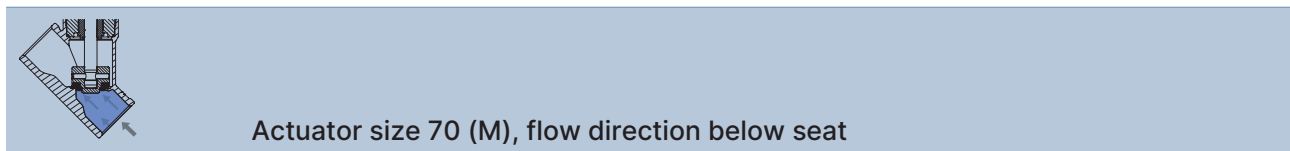

Pilot pressure	max. 10 bar	
Control function A (CFA)		
Minimum control pressure	4.8 bar	
Operating pressure		
Nominal diameter	PTFE	PEEK
DN15	Max. 25 bar	Max. 25 bar
DN20	Max. 25 bar	Max. 25 bar
DN25	Max. 16 bar	Max. 13.5 bar
DN32	Max. 8.5 bar	Max. 8 bar
DN40	Max. 6 bar	-
DN50	Max. 4 bar	-

MAN 1000418103 FI Version: C Status: RL (released | freigegeben) printed: 18.03.2026

Control function B (CFB), control function I (CFI)	
Minimum control pressure	Depending on the operating pressure, see figure below
Operating pressure	
Nominal diameter	PTFE
DN15 to DN40	Max. 25 bar
DN50	Max. 16 bar

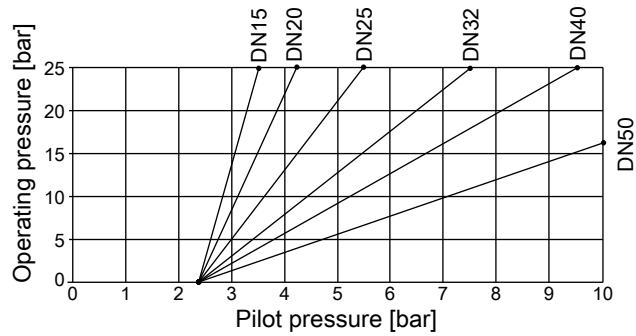

Kuva 8: Minimum control pressure, actuator size 70 (M), control function B and I

Variants with reduced spring force:

Control function A (CFA)	
Minimum control pressure	2.5 bar
Operating pressure	
Nominal diameter	PTFE
DN15	Max. 16 bar
DN20	Max. 12 bar
DN25	Max. 6 bar
DN32	Max. 3.5 bar
DN40	Max. 2 bar

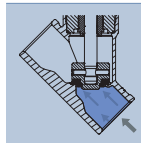

Actuator size 90 (N), flow direction below seat

Pilot pressure	max. 10 bar
----------------	-------------

Control function A (CFA)		
Minimum control pressure	5 bar	
Operating pressure		
Nominal diameter	PTFE	PEEK
DN25	Max. 25 bar	Max. 25 bar
DN32	Max. 25 bar	Max. 19.5 bar
DN40	Max. 16 bar	Max. 13.5 bar
DN50	Max. 10 bar	Max. 8 bar
DN65	Max. 5 bar	-

Control function B (CFB), control function I (CFI)	
Minimum control pressure	Depending on the operating pressure, see figure below
Operating pressure	
Nominal diameter	PTFE
DN25...DN50	Max. 25 bar
DN65	Max. 14 bar

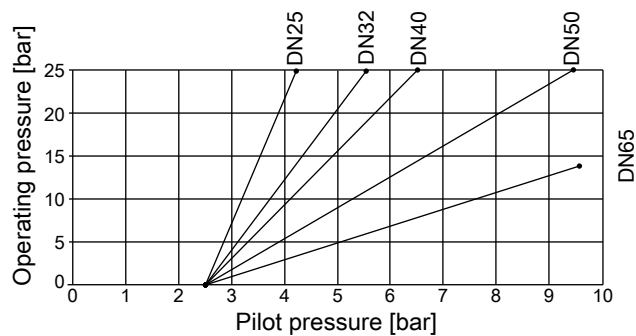

Kuva 9: Minimum control pressure, actuator size 90 (N), control function B and I

Variants with reduced spring force:

Pilot pressure	max. 10 bar
Control function A (CFA)	
Minimum control pressure	2.5 bar
Operating pressure	
Nominal diameter	PTFE
DN32	Max. 9 bar
DN40	Max. 6 bar
DN50	Max. 3.5 bar

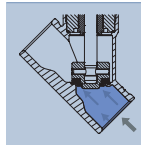

Actuator size 130 (P), flow direction below seat

Pilot pressure	Max. 7 bar	
Control function A (CFA)		
Minimum control pressure	DN32...DN50: 5 bar	
	DN65...DN80: 5.6 bar	
Operating pressure		
Nominal diameter	PTFE	PEEK
DN32	-	Max. 25 bar
DN40	Max. 25 bar	Max. 25 bar
DN50	Max. 25 bar	Max. 23 bar
DN65	Max. 16 bar	Max. 12.5 bar
DN80	Max. 10 bar	Max. 8 bar
Control function B (CFB), control function I (CFI)		
Minimum control pressure	Depending on the operating pressure, see figure below	
Maximum operating pressure [bar]		
Nominal diameter	PTFE	
DN40	Max. 25 bar	
DN50	Max. 25 bar Max. 20 bar ⁵⁾	
DN65	Max. 16 bar Max. 15 bar ⁵⁾	
DN80	Max. 11 bar	

MAN 1000418103 FI Version: C Status: RL (released | freigegeben) printed: 18.03.2026

⁵⁾ According to the Pressure Equipment Directive 2014/68/EU for compressible fluids of Group 1 (dangerous gases and vapours according to Article 4, paragraph (1), c), i), first indent)

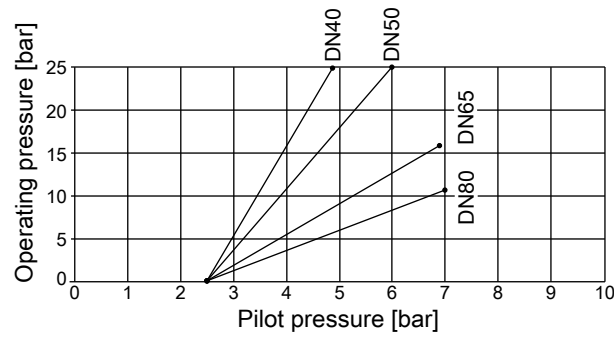

Kuva 10: Minimum control pressure, actuator size 130 (P), control function B and I

Variants with reduced spring force:

Pilot pressure	Max. 7 bar
Control function A (CFA)	
Minimum control pressure	DN40...DN50: 2.5 bar
	DN65: 3.2 bar
	DN80: 3 bar
Operating pressure	
Nominal diameter	PTFE
DN40	Max. 16 bar
DN50	Max. 11 bar
DN65	Max. 7.5 bar
DN80	Max. 4 bar

Flow direction above seat

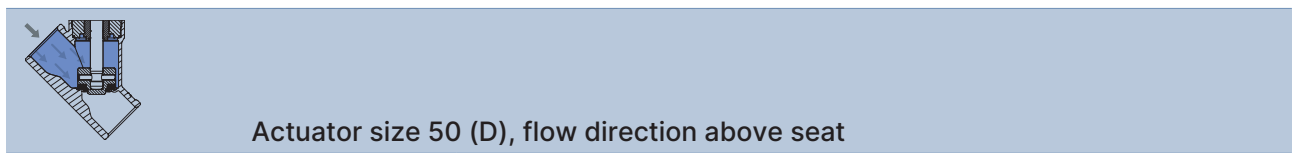

Pilot pressure	max. 10 bar
Control function A (CFA)	
Minimum control pressure	Depending on the operating pressure, see figure below
Operating pressure	Max. 16 bar

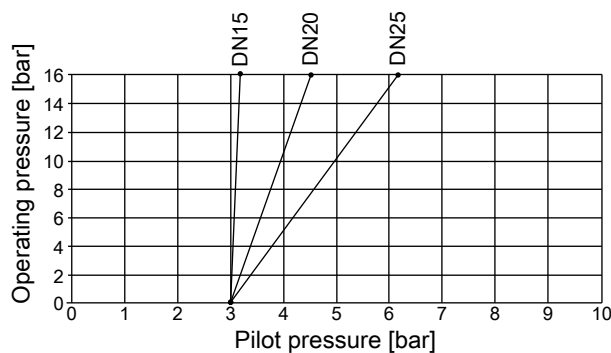

Kuva 11: Minimum control pressure, actuator size 50 (D), control function A

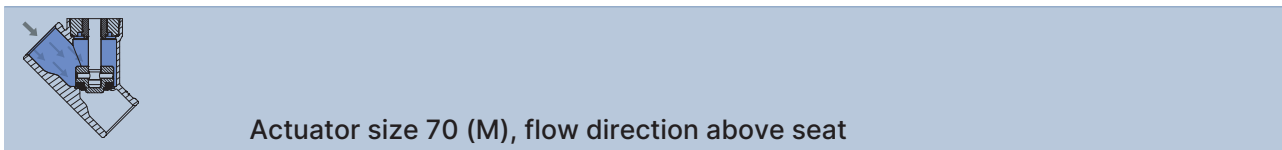

Pilot pressure	max. 10 bar
Control function A (CFA)	
Minimum control pressure	Depending on the operating pressure, see figure below
Operating pressure	
Nominal diameter	PTFE
DN15 to DN40	Max. 16 bar
DN50	Max. 12 bar

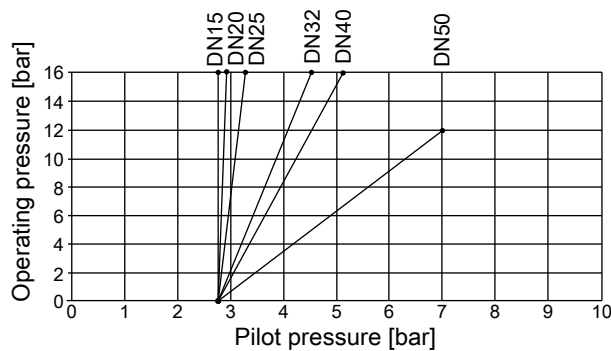

Kuva 12: Minimum control pressure, actuator size 70 (M), control function A

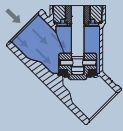

Actuator size 90 (N), flow direction above seat

Pilot pressure	max. 10 bar
Control function A (CFA)	
Minimum control pressure	Depending on the operating pressure, see figure below
Operating pressure	
Nominal diameter	PTFE
DN40...DN50	Max. 16 bar
DN65	Max. 8 bar

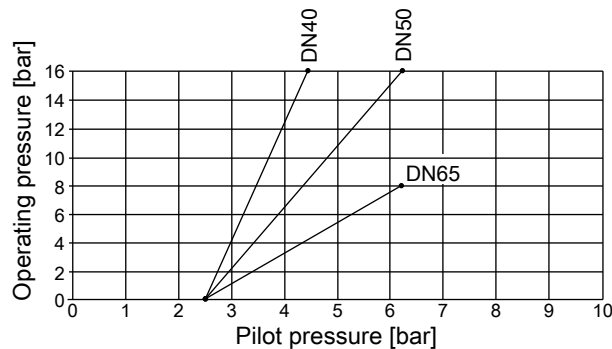

Kuva 13: Minimum control pressure, actuator size 90 (N), control function A

4.3.4 Pressure ranges for 2/3-way valve



“Technical features” for other seal materials and variants not listed: enter the article number in the search bar at country.burkert.com and select the product.

Flow direction below seat

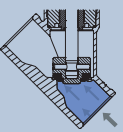

Actuator size 50 (D), flow direction below seat

Pilot pressure	max. 10 bar
Control function A (CFA)	
Minimum control pressure	5 bar
Operating pressure	
Nominal diameter	PTFE
DN15	Max. 16 bar
DN20	Max. 10 bar
DN25	Max. 5 bar

Variants with reduced spring force:

Available on request.

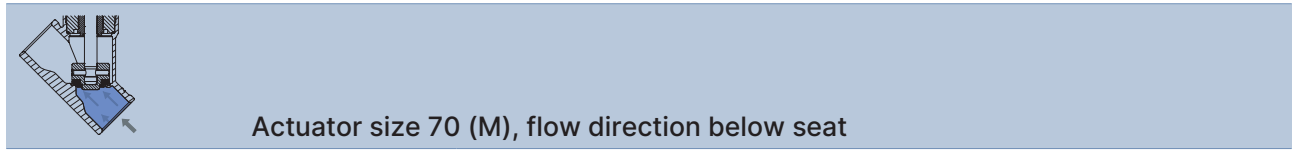

Pilot pressure	max. 10 bar
Control function A (CFA)	
Minimum control pressure	5 bar
Operating pressure	
Nominal diameter	
DN15	Max. 16 bar
DN20	Max. 16 bar
DN25	Max. 12 bar
DN32	Max. 8.5 bar
DN40	Max. 5 bar

Variants with reduced spring force:

Available on request.

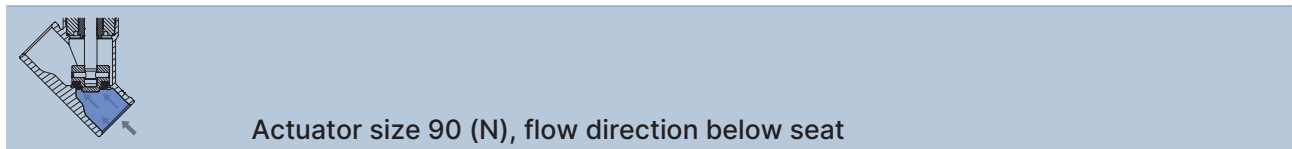

Pilot pressure	max. 10 bar
Control function A (CFA)	
Minimum control pressure	5 bar
Operating pressure	
Nominal diameter	
DN32	Max. 16 bar
DN40	Max. 12 bar
DN50	Max. 7 bar

Variants with reduced spring force:

Available on request.

MAN 1000418103 FI Version: C Status: RL (released | freigegeben) printed: 18.03.2026

Flow direction above seat

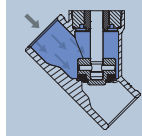

Actuator size 50 (D)...90 (N), flow direction above seat

Pilot pressure	max. 10 bar
Control function A (CFA)	
Minimum control pressure	Depending on the operating pressure, see figure below
Operating pressure	Max. 16 bar

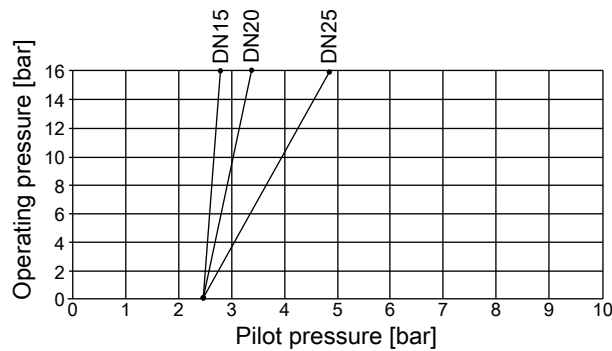

Kuva 14: Minimum control pressure, actuator size 50 (D), control function A

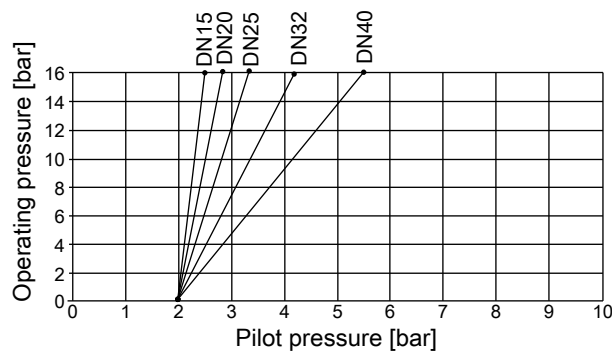

Kuva 15: Minimum control pressure, actuator size 70 (M), control function A

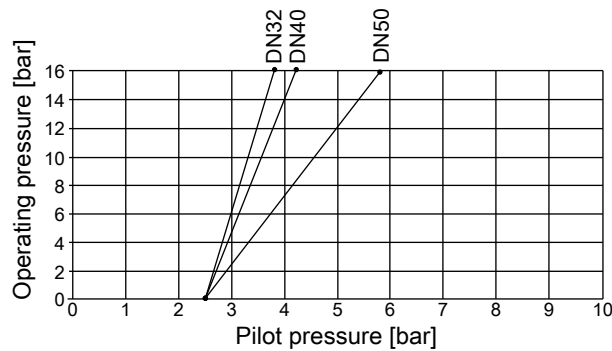

Kuva 16: Minimum control pressure, actuator size 90 (N), control function A

4.3.5 Volume flow values, 2/3-way valve

Actuator size 50 (D)

	Kv value [m ³ /h] at a stroke of										
	0%	10%	20%	30%	40%	50%	60%	70%	80%	90%	100%
DN15	0	1.8	2.5	3.1	3.6	4.0	4.3	4.5	4.7	4.8	5.0
DN20	0	2.6	4.5	5.8	6.8	7.7	8.3	8.8	9.2	9.6	10.0
DN25	0	3.0	5.8	7.9	9.9	11.1	12.2	13.1	13.8	14.4	15.0

Taul. 5: Actuator size 50 (D), volume flow values

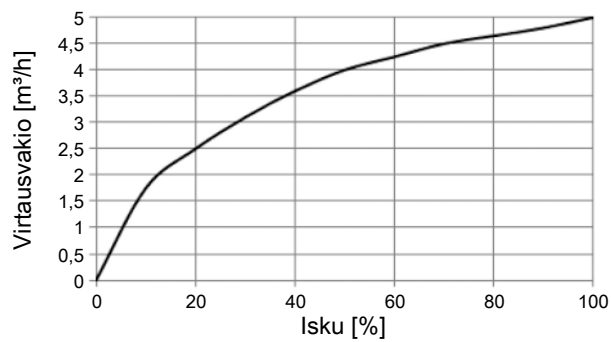

Kuva 17: Actuator size 50 (D), flow characteristic DN15

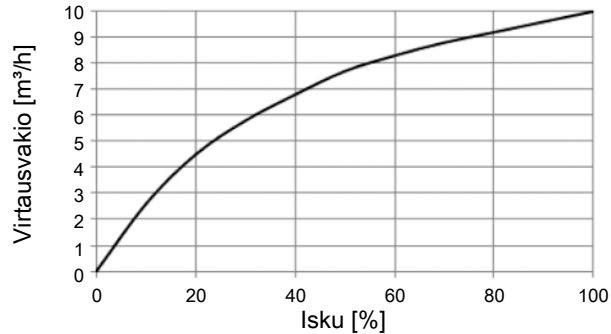

Kuva 18: Actuator size 50 (D), flow characteristic DN20

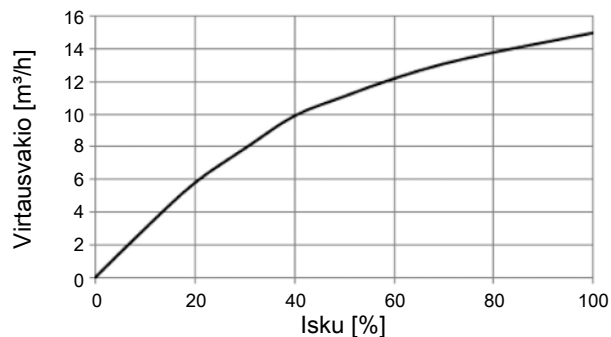

Kuva 19: Actuator size 50 (D), flow characteristic DN25

Actuator size 70 (M)

	Kv value [m ³ /h] at a stroke of										
	0%	10%	20%	30%	40%	50%	60%	70%	80%	90%	100%
DN15	0	1.0	1.8	2.5	3.0	3.4	3.8	4.1	4.5	4.8	5.0
DN20	0	1.5	4.3	6.4	7.5	8.2	8.9	9.4	10.0	10.6	11.0
DN25	0	1.5	4.4	7.8	10.3	12.1	13.5	14.8	15.7	16.5	18.0
DN32	0	5.2	9.4	12.5	15.0	17.4	19.7	22.0	24.0	25.0	26.0
DN40	0	5.5	10.5	14.9	18.8	22.5	25.5	28.5	31.0	34.0	36.0

Taul. 6: Actuator size 70 (M), volume flow values

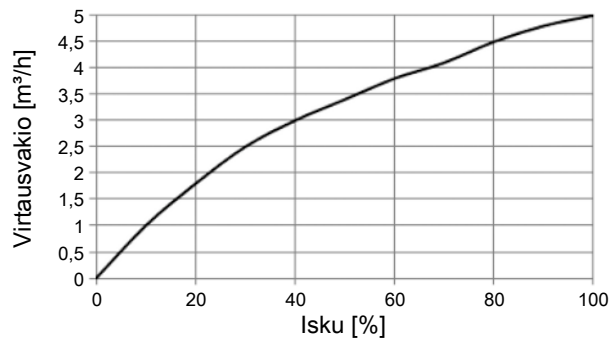

Kuva 20: Actuator size 70 (M), flow characteristic DN15

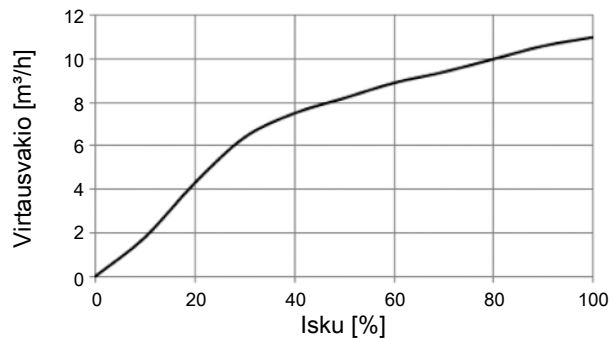

Kuva 21: Actuator size 70 (M), flow characteristic DN20

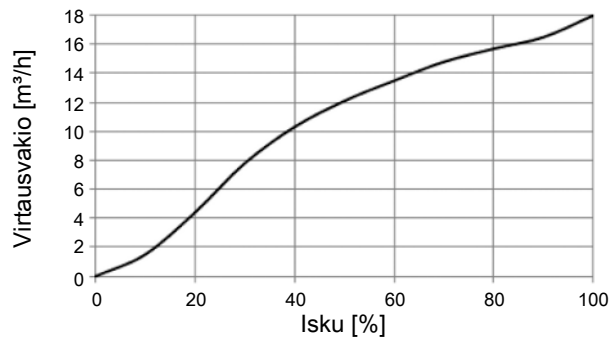

Kuva 22: Actuator size 70 (M), flow characteristic DN25

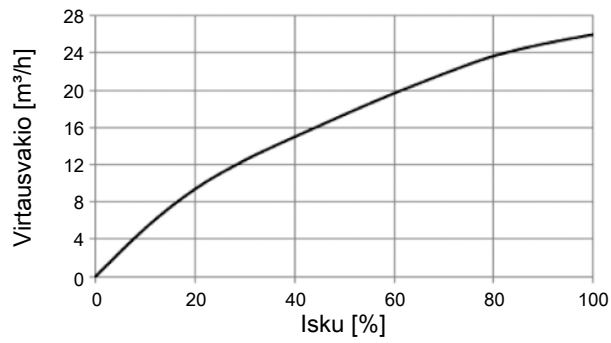

Kuva 23: Actuator size 70 (M), flow characteristic DN32

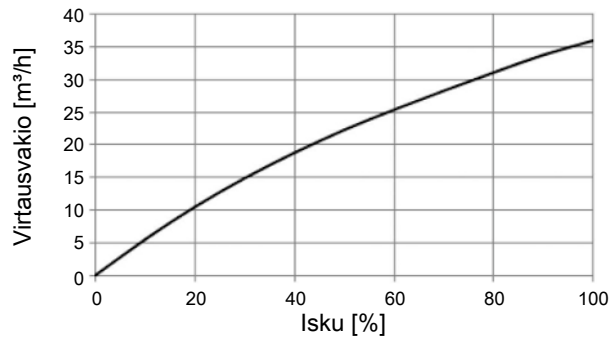

Kuva 24: Actuator size 70 (M), flow characteristic DN40

Actuator size 90 (N)

	Kv value [m³/h] at a stroke of										
	0%	10%	20%	30%	40%	50%	60%	70%	80%	90%	100%
DN32	0	5.4	10.1	13.2	16.2	18.7	21.0	23.0	25.0	26.0	27.0
DN40	0	6.2	11.6	16.1	20.0	23.5	27.5	30.5	33.5	36.5	38.0
DN50	0	8.1	13.5	18.6	23.0	28.0	32.0	36.0	40.0	44.5	49.0

Taul. 7: Actuator size 90 (N), volume flow values

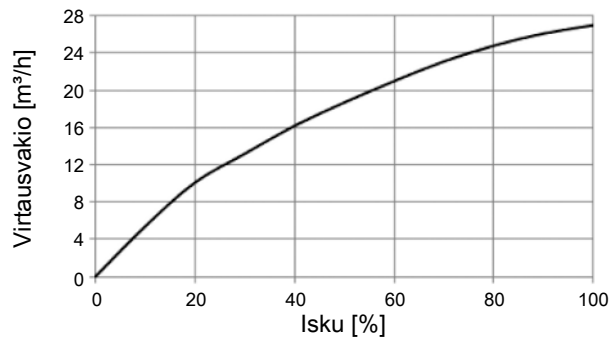

Kuva 25: Actuator size 90 (N), flow characteristic DN32

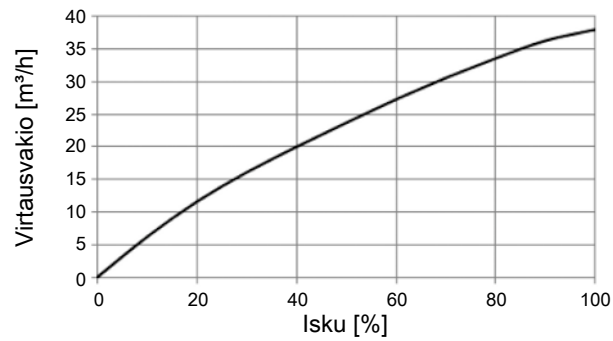

Kuva 26: Actuator size 90 (N), flow characteristic DN40

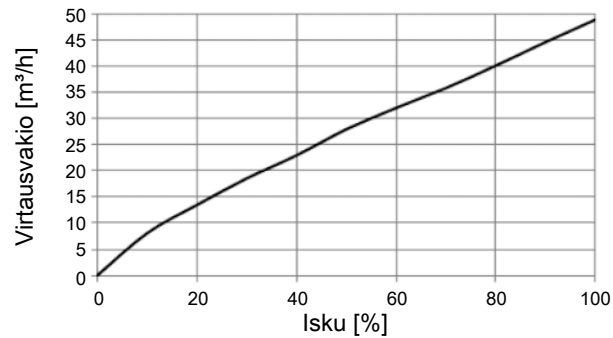

Kuva 27: Actuator size 90 (N), flow characteristic DN50

4.4 Mechanical data

Actuator size	See Determination of actuator size [► 13]
Installation position	Any, preferably actuator face up

Materials

Actuator	PPS and stainless steel
Seal	EPDM, FKM
Body	Stainless steel CF3M
Packing gland (with silicone grease)	PTFE V-rings with spring compensation
Spindle guide	PEEK
Swivel plate	1.4401, 1.4404
Valve seat seal	PEEK, PTFE More on request
spindle	1.4401, 1.4404

Connections

Threaded connection	G, NPT or RC
Welded connection	DIN 11866 Series B, EN ISO 1127, ISO 4200 DIN 11866 Series A, DIN 11850-2 DIN 11866 Series C, ASME BPE SMS 3008
Clamp connection	DIN32676, Series B, ISO 4200 DIN32676, Series A, DIN 11850-2 ASME BPE, ISO 2852, BS 4825
Pilot air port	Push-in connector 6/4 mm or threaded connection 1/4" More on request

5 Installation



Risk of injury or material damage when working on the device or system.

- ▶ Read and observe the chapter **Safety** [▶ 7] before working on the device or system.
-

5.1 Connect the device to pipeline

- Installation position, any, preferably actuator facing up.
- Note the flow direction.
- Make sure that pipelines are in alignment.
- Remove the soiling from pipelines.



Devices with approval according to DIN EN 161 “Automatic shut-off valves for gas burners and gas appliances”

- ▶ Attach dirt trap upstream of the valve. The strainer must prevent the penetration of a 1 mm mandrel.
-

Devices with welded connection

- ▶ **HUOMAUTUS! Before welding in the valve body:** Remove the actuator from the valve body.
- ▶ Weld the valve body into the pipeline.
- ▶ Install the actuator back on the valve body.

Devices with threaded connection, clamp connection or flange connection

- ▶ Connect the valve body to pipeline.

5.2 Remove the actuator from the valve body

To prevent damage, the valve must be in the open position when the actuator is dismantled.

Valves with control function B are opened by spring force in the rest position.

Valves with control function A or I must be pneumatically actuated to open.



1 Pilot air ports 1 and 2 (for assignment, see number on actuator cover)

2 Body connection

5.2.1 Dismantling the actuator on devices without a mounted control unit



1 Collet

Devices with collet

- ▶ Clamp the valve body into a holding device.
- ▶ **HUOMAUTUS! For valves with control function A or I:** Open the valve. To do this, pressurise pilot air port 1 with compressed air (5 bar).
- ▶ Place a suitable open-end wrench on the wrench flat of the body connection.
- ▶ Unscrew the actuator from the valve body.

Devices without collet

- ▶ Clamp the valve body into a holding device.
- ▶ For valves with control function A or I: Install the control unit (refer to the control unit operating instructions).
- ▶ **HUOMAUTUS! For valves with control function A or I:** Open the valve. To do this, pressurise pilot air port 1 with compressed air (5 bar).
- ▶ For valves with control function A or I and pilot valve: Open the valve by manually switching the pilot valve (refer to the operating instructions for the control unit).
- ▶ Place a suitable open-end wrench on the wrench flat of the body connection.
- ▶ Unscrew the actuator from the valve body.

5.2.2 Dismantling the actuator on devices with mounted control unit

- ▶ Clamp the valve body into a holding device.
- ▶ **HUOMAUTUS! For valves with control function A or I:** Open the valve. To do this, pressurise pilot air port 1 with compressed air (5 bar).
- ▶ For valves with control function A or I and pilot valve: Open the valve by manually switching the pilot valve (refer to the operating instructions for the control unit).
- ▶ Place a suitable open-end wrench on the wrench flat of the body connection.
- ▶ Unscrew the actuator from the valve body.

5.3 Install the actuator on the valve body

! VAARA

Danger due to lubricant

Lubricant may contaminate the medium. There is a risk of explosion in oxygen applications.

- ▶ Only use lubricant that is permitted for the medium.

HUOMAUTUS!

Material damage caused by loose screw connections

Where the pipeline is subject to high mechanical stress (vibrations) or in applications with temperatures above 140 °C, the screw connection at the body connection may become loose.

- ▶ Before installation in the pipeline, and at regular intervals when operational, check the screw connection on the body connection. When doing so, observe the tightening torques for the body connection (see [Tightening torques for body connection \[▶ 38\]](#)).

To prevent damage, the valve must be in the open position when the actuator is installed.

Valves with control function B are opened by spring force in the rest position.

Valves with control function A or I must be pneumatically actuated to open.

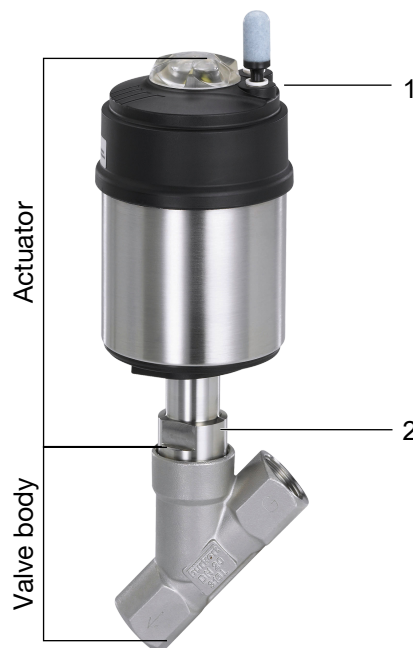

1 Pilot air ports 1 and 2 (for assignment, see number on actuator cover)

2 Body connection

- ▶ Ensure correct position and integrity of the seal in the body connection.
- ▶ Grease the thread of the body connection (e.g. with Klüber paste UH1 96-402 from Klüber).
- ▶ **HUOMAUTUS! For valves with control function A or I:** Open the valve. To do this, pressurise pilot air port 1 with compressed air (5 bar).
- ▶ Screw the actuator into the valve body. Observe the tightening torques for the body connection (see [Tightening torques for body connection \[▶ 38\]](#)).

Nominal diameter DN	Actuator size	Tightening torque [Nm]	Tolerance [Nm]
15	40 (C), 50 (D), 63 (E)	45	+10/-5
20	40 (C), 50 (D), 63 (E), 80 (F)	50	+10/-5
25	50 (D), 63 (E), 80 (F)	60	+10/-5
32	63 (E), 80 (F), 100 (G)	65	+10/-5
40	63 (E), 80 (F), 100 (G), 125 (H)	65	+10/-5
50	63 (E), 70 (M), 80 (F), 90 (N), 100 (G), 125 (H)	70	+10/-5
65	80 (F), 100 (G), 125 (H)	70	+10/-5
65	175 (K), 225 (L)	100	+10/-5
80	125 (H), 130 (P)	120	+10/-5
100	125 (H), 175 (K), 225 (L)	150	+10/-5

Taul. 8: Tightening torques for body connection

5.4 Installing the control unit



For the description, see chapter on “Installation” in the operating instructions for the corresponding control unit.

5.5 Turn the actuator

The position of the pilot air ports can be seamlessly changed by turning the actuator 360°.

To prevent damage, the valve must be in the open position when the actuator is turned.

Valves with control function B are opened by spring force in the rest position.

Valves with control function A or I must be pneumatically actuated to open.



HUOMIO!

Risk of injury due to escaping medium

If the actuator is turned in the wrong direction, the body connection may come loose. This allows medium to escape.

► Only turn the actuator in the direction shown in the figure.

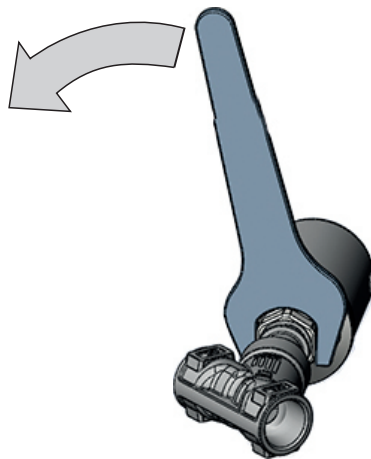

Kuva 28: Turn the actuator

- Clamp the valve body into a holding device.
- **HUOMAUTUS! For valves with control function A or I:** Open the valve. To do this, pressurise pilot air port 1 with compressed air (5 bar).
- To turn the actuator, use an open-end wrench on the hexagon nut of the actuator connection. Hold the hexagon nut of the body connection with an open-end wrench.
- **HUOMIO! Observe the direction of rotation!** Turn the actuator on the hexagon nut of the drive connection in the direction shown in the figure until the desired position is reached.

6 Pneumatic connection



Risk of injury or material damage when working on the device or system.

- ▶ Read and observe the chapter [Safety \[▶ 7\]](#) before working on the device or system.

6.1 Connect the device pneumatically



VAROITUS!

Risk of injury from connection of unsuitable hoses

Inappropriate hoses can come loose and swing around.

- ▶ Use only hoses which are authorised for the indicated pressure and medium temperature range.
- ▶ Observe the data sheet specifications from the hose manufacturers.



VAROITUS!

For control function I: Risk of injury in the event of pilot pressure failure

The valve stays in an undefined position in the event of a pilot pressure failure.

- ▶ Switch off the pressure before working on the device or system. Vent or drain the lines.
- ▶ To ensure a controlled restart, first pressurise the device with pilot pressure, then switch on the medium.



The position of the pilot air ports can be seamlessly changed by turning the actuator 360°. The procedure is described in chapter [Turn the actuator \[▶ 39\]](#).



For use in aggressive environments

- ▶ Drain the free pneumatic connections into a neutral atmosphere using a pneumatic hose.

Control functions A and B:

- ▶ Connect the control medium to the pilot air port 1 of the actuator.

Control function A, 3-position actuator:

- ▶ Connect the control medium to the pilot air port 1 and pilot air port 2 of the actuator.
Pressure at pilot air port 1: Valve opens.
Pressure at pilot air port 1 and 2: Valve in centre position.

Control function I:

- ▶ Connect the control medium to the pilot air port 1 and pilot air port 2 of the actuator.
Pressure at pilot air port 1: Valve opens.
Pressure at pilot air port 2: Valve closes.

Silencer

For devices with push-in connection, the silencer to reduce the exhaust air volume is loosely supplied.

- ▶ Connect the silencer to the free exhaust port 2.



In aggressive environments, drain open pneumatic connections into a neutral atmosphere using a pneumatic hose.

Pneumatic hoses

Pneumatic hoses with an external diameter of 6 mm or 1/4" for insertion into push-in connections. Or optionally with 1/8" external thread fitting for screwing into threaded connection.

7 Commissioning



Risk of injury or material damage when working on the device or system.

- ▶ Read and observe the chapter **Safety** [▶ 7] before working on the device or system.

7.1 Commission the device



VAROITUS!

For control function I: Risk of injury in the event of pilot pressure failure

The valve stays in an undefined position in the event of a pilot pressure failure.

- ▶ Switch off the pressure before working on the device or system. Vent or drain the lines.
- ▶ To ensure a controlled restart, first pressurise the device with pilot pressure, then switch on the medium.



VAROITUS!

Risk of injury from high pressure or hot medium

Excessively high pressure or temperatures may damage the device and cause leaks.

- ▶ Observe values for pressure and medium temperature indicated on the type label.



In the case of devices with control unit, observe start-up in the operating instructions for the corresponding control unit.

- ▶ Adjust the pilot pressure in accordance with the information on the type label and in technical data.
- ▶ Commission the device.

7.1.1 Flow direction below the seat



VAROITUS!

Leaking valve seat with flow direction below seat.

If pilot pressure for control function B and control function I is too low or operating pressure is too high, this can cause the valve seat to leak.

- ▶ Comply with the minimum control pressure and the maximum operating pressure values.

7.1.2 Flow direction above the seat



VAARA

Bursting lines and bursting device with flow direction above the seat.

In the case of liquid media, a pressure surge can lead to the bursting of lines and device.

- ▶ Do not use valves with flow direction above the seat for liquid media.

7.2 Set the middle position on 3-position actuator

	Open position [100% stroke]	Middle position [0...100% stroke]
Pilot air port 1	5...7 bar	5...7 bar
Pilot air port 2	0 bar	5...7 bar

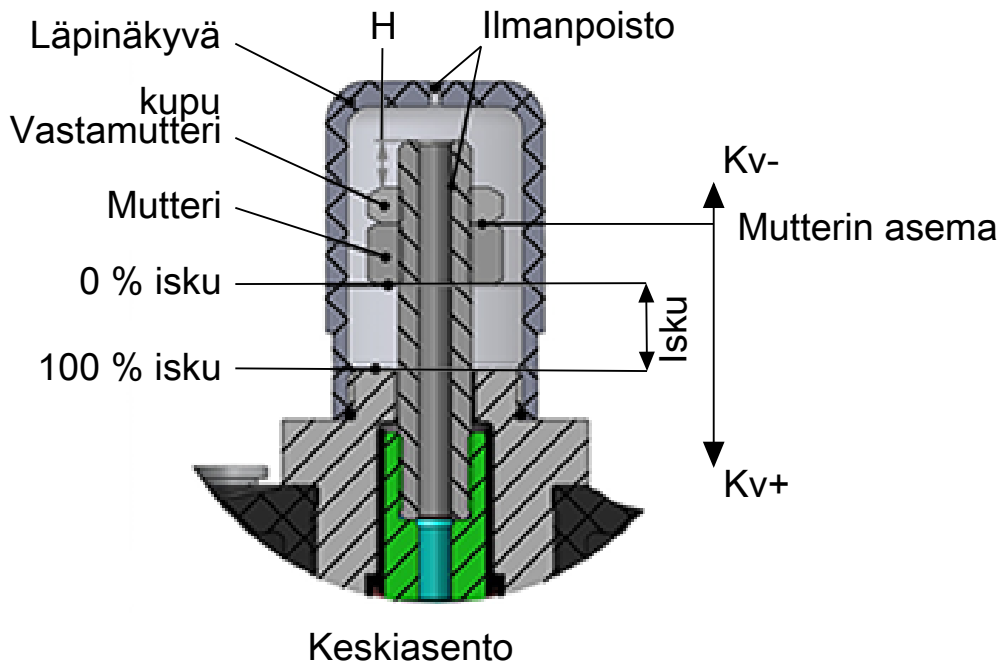

Kuva 29: Setting the middle position

- ▶ Unscrew the transparent cap: Actuator sizes 50, 70 and 90, width across flats 28.
- ▶ Pressurise pilot air port 1 with compressed air at 5 bar.
- ▶ Loosen the locknut.
Actuator size 50: width across flats 13
Actuator size 70 and 90: width across flats 17
- ▶ Adjust the middle position with the nut.
- ▶ Tighten the locknut.
Actuator size 50 max. 20+5 Nm
Actuator size 70 max. 30+5 Nm
Actuator size 90 max. 45+5 Nm
- ▶ Unscrew the transparent cap.

To limit the middle position to 50% of the total stroke, adjust the nuts to dimension H.

Actuator size [mm]	Seat size	Dimension H ±0.3 [mm]	Total stroke [mm]
50	15	10.4	10.8
	20	8.4	14.8
	25	6.4	18.8
70	15	12.9	10
	20	8.9	18
	25	8.9	18
	32	8.9	18
	40	8.9	18
90	32	10.6	20.4
	40	10.6	20.4
	50	10.6	20.4

Taul. 9: Setting the middle position to 50% of the total stroke

8 Maintenance



Risk of injury or material damage when working on the device or system.

- ▶ Read and observe the chapter **Safety** [▶ 7] before working on the device or system.

8.1 Control

- ▶ Check the following parts for leaks

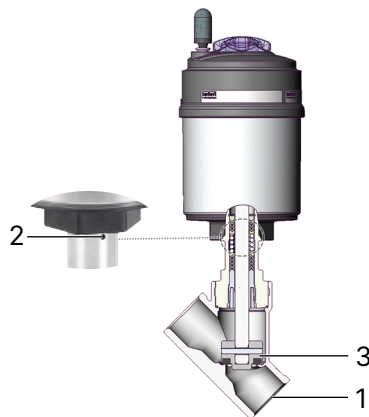

Kuva 30: Leakage control

Check	Action
Media connectors (1)	▶ Repair media connectors
Relief bore (2)	▶ Replace packing gland or actuator
Swivel plate (3)	▶ Replace the valve set

Taul. 10: Visual inspection

8.2 Cleaning

HUOMAUTUS!

Avoid causing damage with cleaning agents.

- ▶ Before cleaning, check that the cleaning agents are compatible with device materials and seals.
- ▶ Only use commercially available cleaning agents for external cleaning.

9 Troubleshooting

9.1 Actuator does not switch

Syy	Ratkaisu
Pilot air port interchanged.	<ul style="list-style-type: none"> ▶ Connect the pilot air correctly: CFA (2/2-way valve): Pilot air port 1.
	<ul style="list-style-type: none"> ▶ Connect the pilot air correctly: CFB: Pilot air port 1.
	<ul style="list-style-type: none"> ▶ Connect the pilot air correctly: CFI: Pilot air port 1: Open, Pilot air port 2: Close.
	<ul style="list-style-type: none"> ▶ Connect the pilot air correctly: CFA (2/3-way valve): Pilot air port 1: Open, Pilot air port 2: Centre position.
Pilot pressure too low.	▶ Observe pressure data on the type label.
Operating pressure too high.	▶ Observe pressure data on the type label.
Flow direction switched.	▶ Observe the direction of the arrow on the type label.

9.2 Valve is not tight

Syy	Ratkaisu
Pilot pressure too low.	▶ Observe pressure data on the type label.
Operating pressure too high.	▶ Observe pressure data on the type label.
Flow direction switched.	▶ Observe the direction of the arrow on the type label.
Dirt between seal and valve seat.	▶ Install the dirt trap.
Valve seat seal worn.	▶ Install the new swivel plate.

9.3 Valve is leaking on the relief bore

Syy	Ratkaisu
Packing gland worn.	▶ Replace the packing gland or actuator.

10 Uninstallation



Risk of injury or material damage when working on the device or system.

- ▶ Read and observe the chapter **Safety** [▶ 7] before working on the device or system.
-

10.1 Disassemble the device

- ▶ Loosen the pneumatic connection.
- ▶ Disassemble the device.

11 Spare parts and accessories



Risk of injury and/or damage due to incorrect parts.

- ▶ Use only original accessories and original spare parts from Bürkert.



Order the parts directly on our [eShop](#).

11.1 Ordering spare parts

Spare parts can be ordered via the Bürkert [eShop](#) or the Bürkert homepage.

Order via the e-shop

- ▶ Visit the Bürkert [eShop](#).
- ▶ Log in or register.
- ▶ Enter the article number of the device in the search box.
- ▶ Select spare parts and complete your order.

Order via the Bürkert website

- ▶ Go to the Bürkert website and select "Service & Support > Spare Parts Kits".
- ▶ Enter the article number of the device in the search box.
- ▶ Select spare parts and complete your order.

11.2 Accessories

11.2.1 Installation tool for packing gland

Socket wrench

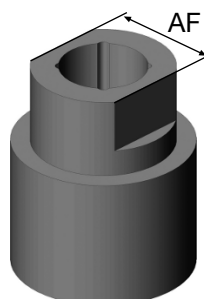

Ø Spindle [mm]	Nominal diameter DN	Width across flats [mm]	Article number
10	15...50	19	683221
14	32...80	21	683223

12 Logistics

12.1 Transport and storage

- ▶ Protect the device against moisture and dirt in the original packaging during transportation and storage.
- ▶ Avoid UV radiation and direct sunlight.
- ▶ Protect connections from damage with protective caps.
- ▶ Observe permitted storage temperature.

12.2 Disposal

Environmentally friendly disposal



- ▶ Follow national regulations regarding disposal and the environment.
- ▶ Collect electrical and electronic devices separately and dispose of them as special waste.

Further information at country.burkert.com