

Type MS06

FIA sensor cube for iron content



Operating Instructions

We reserve the right to make technical changes without notice.
Technische Änderungen vorbehalten.
Sous réserve de modifications techniques.

© Bürkert SAS, 2019

Operating Instructions 1910/00_EU-ML 00568298 ORIGINAL_DE

1	ABOUT THE OPERATING INSTRUCTIONS	5
1.1	Symbols used	5
1.2	Definition of the term product	5
1.3	Definition of the term system.....	6
1.4	Definition of the term büS.....	6
1.5	Definition of the term "reagent unit"	6
2	INTENDED USE.....	6
3	BASIC SAFETY INFORMATION.....	7
4	GENERAL INFORMATION.....	8
4.1	Contact	8
4.2	Warranty conditions	8
4.3	Information on the Internet.....	8
5	DESCRIPTION	9
5.1	General description and function.....	9
5.2	Description of the product without housing for the type 8905.....	9
5.3	Description of the product mounted in a housing for the type 8905.....	10
6	TECHNICAL DATA.....	11
6.1	Conditions of use.....	11
6.2	Conformity to standards and directives	11
6.3	Materials the product is made of	11
6.4	Fluid data.....	11
6.5	Measurement data	12
6.6	Electrical data	12
6.7	Data transfer	12
7	INSTALLATION	13
7.1	Safety instructions	13
7.2	Installation on a wall of the product with housing for the type 8905.....	13
7.3	Installation of the product without housing for the type 8905.....	13
7.3.1	Arrangement and equipment of the backplanes	14
7.3.2	Mounting of the backplanes on 2 standard rails (TS35).....	15

7.3.3	Mounting the product on a 4 backplane combination	15
7.3.4	Mounting the product on a 3 backplane combination	16
7.3.5	Installation of the reagent unit	17
7.4	Fluid system installation	17
7.4.1	Fluidic connection of the product with housing	17
7.4.2	Fluidic connection of the product mounted on a standard rail	17
7.5	Electrical connection	18
7.5.1	Pin assignment for the M12 connectors	18
7.5.2	Connecting the product with housing to the power supply and fieldbus	18
7.5.3	Electrically connecting the product without housing	20
8	COMMISSIONING	21
8.1	Safety instructions	21
8.2	Before commissioning the product	21
8.3	Procedure for commissioning the product	22
8.4	Procedure for commissioning after a flow interruption	22
9	ADJUSTMENT AND OPERATION	23
9.1	Safety instructions	23
9.2	How to adjust the product	23
9.3	General information on the display software type ME21	23
9.4	"Device" view of the product	24
9.5	"Function" view of the product	25
9.6	Detailed views of the büS function	26
9.7	Setting the parameters of function FIA	28
9.7.1	Functions that can be adjusted in "Parameter" view	28
9.7.2	Setting the time interval between 2 analyses	28
9.7.3	Setting the automatic start of a calibration	29
9.7.4	Setting the automatic start of a cleaning cycle	29
9.7.5	Manually modifying the calibration values	30
9.7.6	Connecting the product with the reagent unit to monitor the operating agents (only MZ30 with electronics)	30
9.7.7	Monitoring the fill level of the operating agents, MZ30 without electronics	31
9.7.8	Monitoring the fill level of the waste container	31
9.7.9	Switching off the monitoring of the fill level of the waste container	31

9.7.10	Setting the fill level of the waste container to zero.....	32
9.7.11	Monitoring the expiration date of the operating agents (only MZ30 with electronics).....	32
9.7.12	Monitoring the iron content.....	32
9.8	Reading the product diagnosis.....	33
9.8.1	Reading the current product status.....	33
9.8.2	Reading the total operating time of the product.....	33
9.8.3	Reading the number of analyses since first commissioning.....	34
9.8.4	Reading the number of analyses before the next automatic calibration.....	34
9.8.5	Reading the number of analyses before the next automatic cleaning.....	34
9.8.6	Reading the connection status between the product and reagent unit.....	34
9.9	Setting maintenance work.....	35
9.9.1	Reading the current function and tracking its progress.....	35
9.9.2	Reading the total and remaining time of a function in progress.....	36
9.9.3	Starting automatic analyses, calibrations and cleaning cycles.....	36
9.9.4	Switching off automatic analyses, calibrations and cleaning cycles.....	37
9.9.5	Setting the behaviour of the product after a power interruption.....	37
9.9.6	Manually starting an analysis.....	38
9.9.7	Manually starting a calibration.....	38
9.9.8	Manually starting a cleaning cycle.....	39
9.9.9	Manually starting degassing.....	39
9.9.10	Manually starting filling of the sample fluid system.....	40
9.9.11	Manually starting filling of the reagent tube.....	40
9.9.12	Manually starting filling of the calibration tube.....	40
9.9.13	Manually starting filling of the cleaning tube.....	41
9.9.14	Manually starting commissioning.....	41
9.9.15	Manually starting draining of the reagent tube.....	42
9.9.16	Manually starting draining of the calibration tube.....	42
9.9.17	Manually starting draining of the tube for cleaning solution.....	42
9.9.18	Activate or stop simulation of an iron content.....	43
9.9.19	Hold the last measured value.....	44
9.9.20	Switching on the saving of the iron contents measured during calibration.....	44
9.9.21	Switching off the saving of the iron contents measured during calibration.....	44
9.9.22	Step-by-step replacement of operating agent bottles.....	45
10	MAINTENANCE AND TROUBLESHOOTING.....	47
10.1	Safety instructions.....	47

10.2	Performing maintenance work	47
10.3	Cleaning the outside of the product.....	47
10.4	Removal of the product from the backplane	48
10.5	Troubleshooting, when no message is displayed.....	48
10.6	Troubleshooting if a message is displayed.....	49
10.6.1	Message "Low limit in reagent-solution tank detected"	49
10.6.2	Message "Low limit in cleaning-solution tank detected".....	49
10.6.3	Message "Low limit in calibration-solution tank detected"	50
10.6.4	Message "Measured Fe value too large"	50
10.6.5	Message "Measured Fe value too low"	51
10.6.6	Message "Waste container fill level limit reached"	52
10.6.7	Message "Measured Fe value exceeds valid range"	53
10.6.8	Message "Inlet temperature low limit"	53
10.6.9	Message "Inlet temperature upper limit"	53
10.6.10	Message "The test of valves and pumps failed".....	53
10.6.11	Message "Power supply voltage limit has been reached"	54
10.6.12	Message "Container 1 in MZ30 is placed at the wrong position"	54
10.6.13	Message "Container 2 in MZ30 is placed at the wrong position"	54
10.6.14	Message "Container 3 in MZ30 is placed at the wrong position"	55
10.6.15	Message "Reagent solution expiration date"	55
10.6.16	Message "Clean solution expiration date"	56
10.6.17	Message "Calibration solution expiration date"	56
10.6.18	Message "Communication with MZ30 failed"	57
10.6.19	Message "Initializing communication with MZ30"	57
10.6.20	Message "Automatic calibration failed".....	57
11	SPARE PARTS AND ACCESSORIES.....	58
12	PACKAGING, TRANSPORT.....	58
13	STORAGE.....	59
13.1	Storage of the product.....	59
13.2	Commissioning the product after a period of storage.....	59
14	DISPOSAL OF THE PRODUCT.....	59

1 ABOUT THE OPERATING INSTRUCTIONS

The Operating Instructions describe the entire life cycle of the product. Please keep these Operating Instructions in a safe place, accessible to all users and any new owners.

The Operating Instructions contain important safety information.

Failure to comply with these instructions can lead to hazardous situations.

- ▶ The Operating Instructions must be read and understood.

1.1 Symbols used



DANGER

Warns against an imminent danger.

- ▶ Failure to observe this warning results in death or in serious injury.



WARNING

Warns against a potentially dangerous situation.

- ▶ Failure to observe this warning can result in a serious injury or even death.



CAUTION

Warns against a possible risk.

- ▶ Failure to observe this warning can result in substantial or minor injuries.

NOTICE

Warns against material damage.

- ▶ Failure to observe this warning may result in damage to the product or system.



Indicates additional information, advice or important recommendations.



Refers to information in the Operating Instructions or in other documents.

- ▶ Indicates an instruction to be carried out to avoid a danger, a warning or a possible risk.

→ Indicates a procedure to be carried out.

- ✓ Indicates the result of a specific instruction.

1.2 Definition of the term product

The term "product" used within these Operating Instructions always refers to the sensor cube of the flow injection analysis type MS06.

1.3 Definition of the term system

The term "system" used within these Operating Instructions, always refers to the Online Analysis System type 8905.

1.4 Definition of the term bÜS

The term "bÜS" used within these Operating Instructions always refers to the fieldbus developed by Bürkert.

1.5 Definition of the term "reagent unit"

The term "reagent unit" used within these Operating Instructions always refers to the reagent unit type MZ30.

2 INTENDED USE

Use of this product that does not comply with the instructions could present risks to people, nearby installations and the environment.

The product is used for measuring dissolved iron in water and must be operated with reagent unit type MZ30.

- ▶ This product must be protected against electromagnetic interference, ultraviolet rays and, when installed outdoors, the effects of climatic conditions.
- ▶ This product must be used in compliance with the characteristics and commissioning and use conditions specified in the contractual documents and in the Operating Instructions.
- ▶ Requirements for the safe and proper operation of the product are proper installation as well as careful operation and maintenance.
- ▶ Only use the product as intended.

3 BASIC SAFETY INFORMATION

This safety information does not take into account any contingencies or occurrences that may arise during installation, use and maintenance of the product.

The operating company is responsible for the respect of the local safety regulations including for the staff safety.



DANGER

Danger due to the nature of the operating agents.

- ▶ Observe the rules in force concerning accident prevention and safety and which relate to the use of hazardous products.
- ▶ Observe the information in the safety data sheet. The safety data sheets can be found at
 - Reagent: <http://sds-id.com/200123-8>
 - Cleaning solution: <http://sds-id.com/200124-7>
 - Calibration solution: <http://sds-id.com/200122-9>
- ▶ Use a waste container of at least 2.5 litres.
- ▶ Dispose of waste containing chemicals produced by the system in an environmentally friendly manner.



Various dangerous situations.

To avoid personal injury take care:

- ▶ to prevent any unintentional power supply switch-on.
- ▶ to carry out the installation and maintenance work by qualified and skilled staff with the appropriate tools.
- ▶ to use the product only if in perfect working order and in compliance with the instructions provided in these Operating Instructions
- ▶ to observe the general technical rules.
- ▶ not to use the product in explosive atmospheres.
- ▶ not to use the product in an environment incompatible with the materials from which the product is made.
- ▶ not to make any modifications to the product.

NOTICE

Elements/components sensitive to electrostatic discharges.

This product contains electronic components sensitive to electrostatic discharges. They may be damaged if they are touched by an electrostatically charged person or object. In the worst-case scenario, these components are instantly destroyed or go out of order as soon as they are activated.

- To minimize or even avoid all damage due to electrostatic discharge, take all the precautions described in the EN 61340-5-1 norm.
- Do not touch any of the live electrical components.

4 GENERAL INFORMATION

4.1 Contact

To contact the manufacturer of the product, use the following address:

Bürkert SAS

Rue du Giessen

BP 21

F-67220 TRIEMBACH-AU-VAL

The addresses of our international branches can be found on the Internet at: www.burkert.com

4.2 Warranty conditions

The condition governing the legal warranty is the conforming use of the product in observance of the operating conditions specified in these Operating Instructions.

4.3 Information on the Internet

You can find the Operating Instructions and technical data sheets regarding type MS06 at: www.burkert.com

5 DESCRIPTION

5.1 General description and function

The product together with reagent unit type MZ30 represent a variant of the system type 8905.

You may have obtained the product as one of two possible variants:

- either mounted in a housing for the type 8905,
- or without housing for the type 8905.

The product must be used with a reagent unit. The product analyses the sample water using a reagent to determine the iron content. The reagent, together with the required calibration solution and cleaning solution, are provided through the reagent unit. The analysis is performed according to the principle of flow injection analysis.



Further details concerning the reagent unit can be found in the relevant Operating Instructions at: www.buerkert.de.

5.2 Description of the product without housing for the type 8905

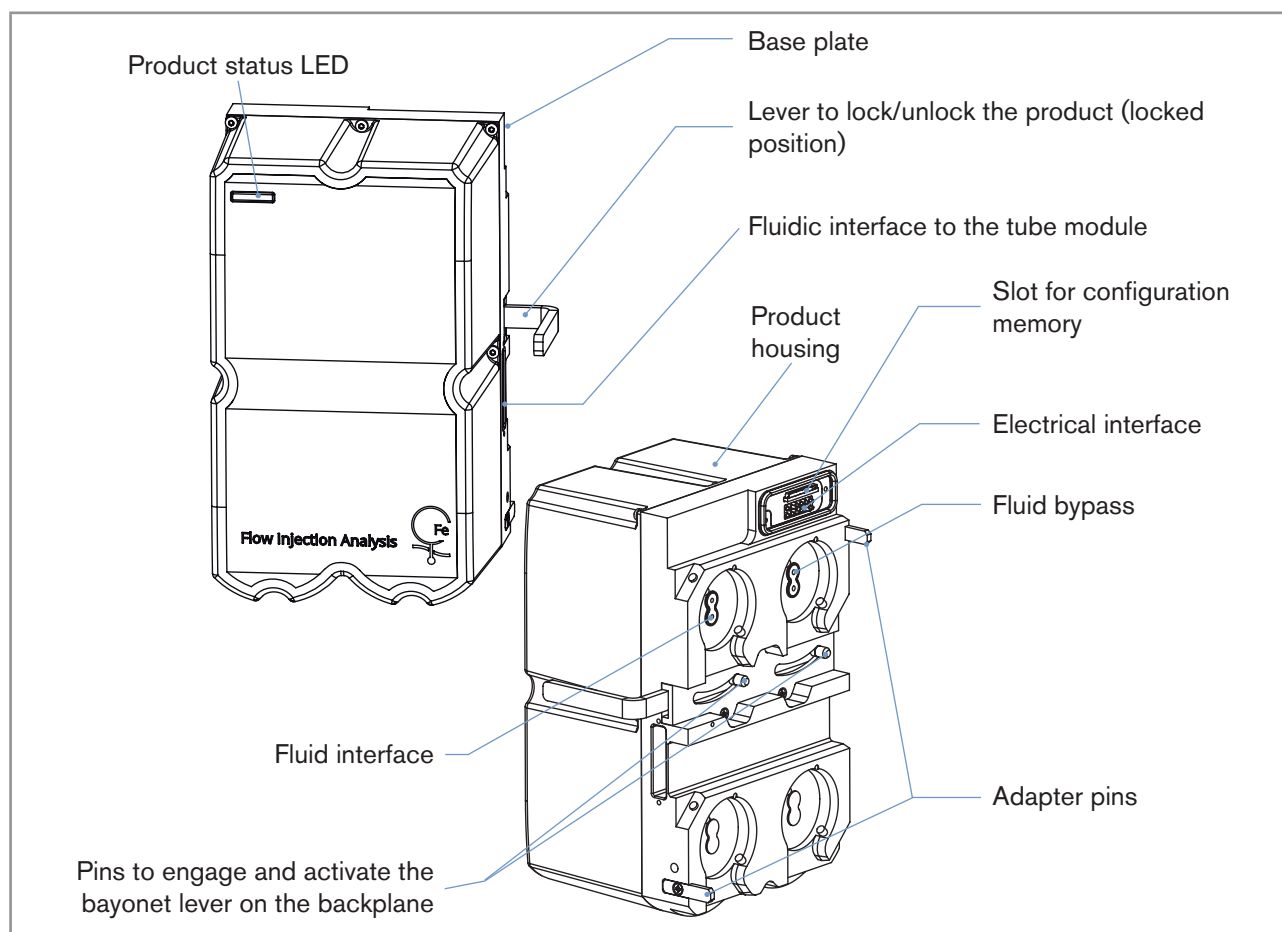

Figure 1: Description of the product without housing for the type 8905

5.3 Description of the product mounted in a housing for the type 8905

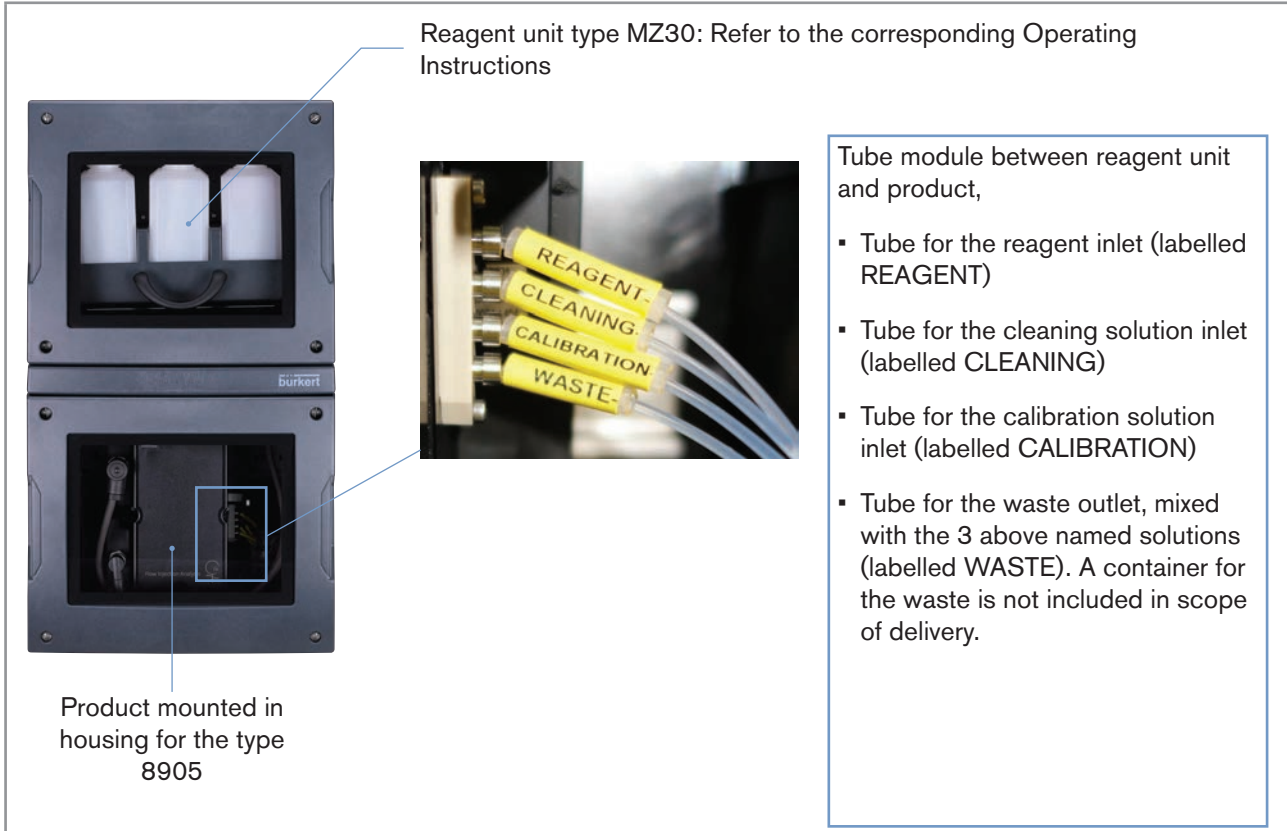

Figure 2: Description of system type 8905 with product and reagent unit

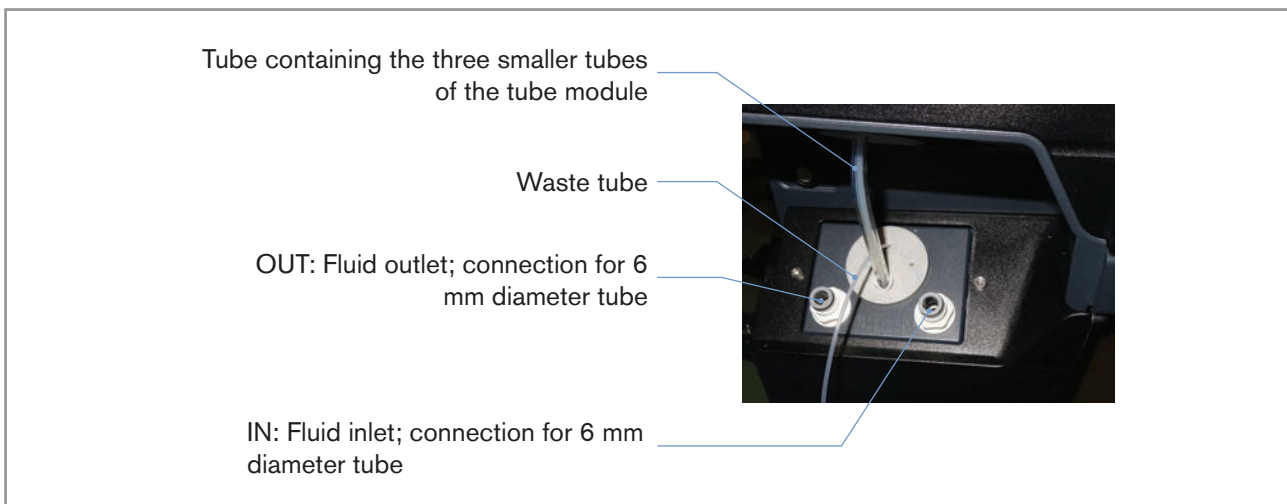

Figure 3: Fluidic connections of the system with product and reagent unit

The electrical connections and sample water connections are made via the backplane of system type 8905. See the corresponding Operating Instructions.

6 TECHNICAL DATA

6.1 Conditions of use

Ambient temperature	+10...+40 °C
Recommended working temperature	+20 °C
Air humidity	< 90 %, without condensation
Protection rating acc. to EN 60529	<ul style="list-style-type: none"> ▪ IP65, if plugged into the backplane ▪ IP20 as a stand-alone product
Maximum height above sea level	2000 m

6.2 Conformity to standards and directives

The standards used to demonstrate conformity with the Directives can be consulted in the EC type examination certificate and/or the EC declaration of conformity (if applicable).

6.3 Materials the product is made of

Part	Material
Housing	Polycarbonate
Seals	EPDM, FKM, NBR
Lever	Stainless steel
Backplane	Anodized aluminium
Materials coming into contact with the sample	EPDM, FKM, NBR, PMMA, PEEK

6.4 Fluid data

<ul style="list-style-type: none"> ▪ Type of fluid ▪ pH value 	<ul style="list-style-type: none"> ▪ Drinking water, industrial water ▪ pH 4...9
Minimum flow rate	See the pressure versus flow diagram in Figure 4
Water sample pressure	PN1 bar
Water sample temperature	+10...+40 °C

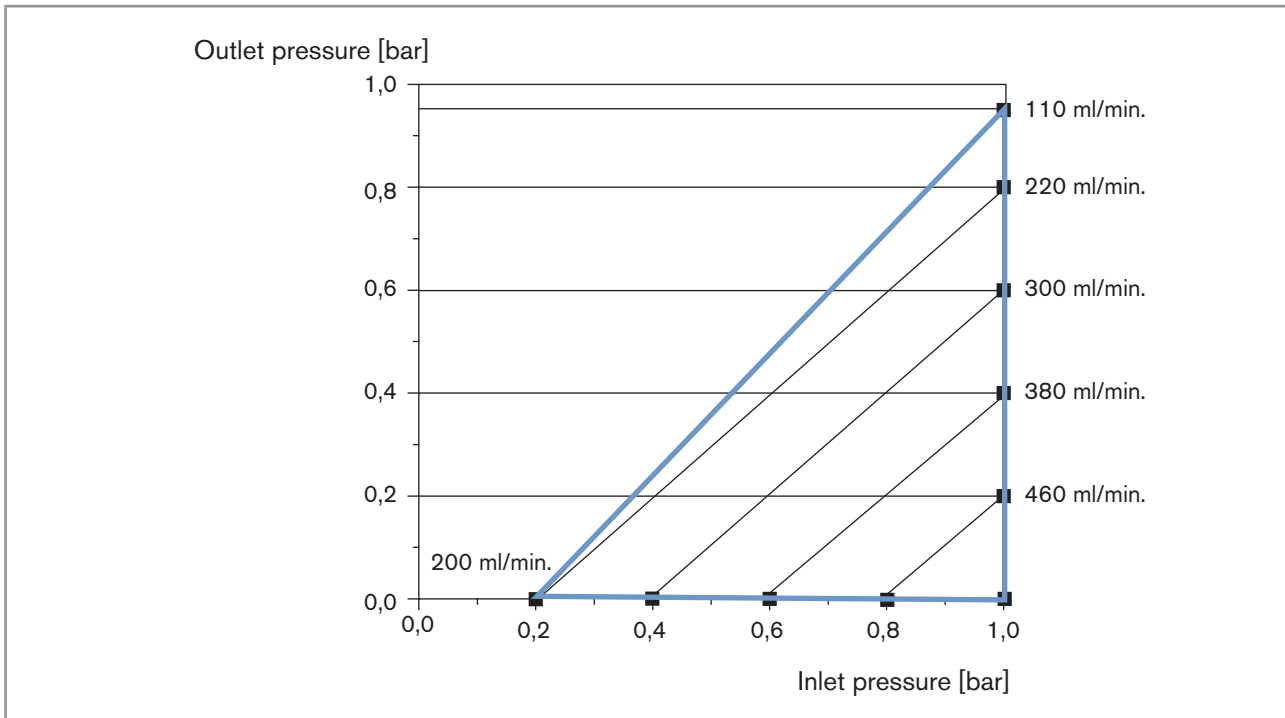

Figure 4: Pressure versus flow diagram

6.5 Measurement data

Dissolved iron	
▪ Measurement range	▪ 0...10 mg/l
▪ Resolution	▪ ± 0.01 mg/l
▪ Measurement value deviation ("Measurement value offset", as defined in standard JCGM 200:2012)	▪ ± 0.05 mg/l or 5%
▪ Measurement principle	▪ Flow injection with photometric detection

6.6 Electrical data

Operating voltage	24 V DC, via the backplane of system type 8905
Power consumption	2,2...12,7 W

6.7 Data transfer

Internal data transfer	via the büS
External communication via status LED	In accordance with NAMUR NE 107

7 INSTALLATION

7.1 Safety instructions

NOTICE

Risk of damage to the product due to non-conforming installation

- The electrical and fluidic installations can only be carried out by qualified and skilled staff with the appropriate tools.
- Respect the installation instructions of the system.

NOTICE

Risk of damage to the product due to the power supply.

- Shut down and isolate the electrical power source before carrying out any work on the system.

NOTICE

Risk of damage to the product due to the environment

- Protect the products against electromagnetic interference.

7.2 Installation on a wall of the product with housing for the type 8905



When installing the product, refer also to the Operating Instructions of reagent unit MZ30.



A slanting position of the product can lead to errors during sampling.

- ▶ Mount the housing as vertically as possible.

→ Install the product with housing for the type 8905 on a wall as described in the Operating Instructions of the type 8905.

7.3 Installation of the product without housing for the type 8905

If the product is supplied without housing, it can be mounted on either a 3 or a 4 backplane combination and the backplanes are installed on a standard rail (TS35). Respect the installation instructions: [chap. 7.3.1 Arrangement and equipment of the backplanes](#), [chap. 7.3.2 Mounting of the backplanes on 2 standard rails \(TS35\)](#), [chap. 7.3.3 Mounting the product on a 4 backplane combination](#) and [7.3.5 Installation of the reagent unit](#).



When installing the product, refer also to the Operating Instructions of reagent unit MZ30.



A slanting position of the product can lead to errors during sampling.

- ▶ Mount the backplanes as vertically as possible.

7.3.1 Arrangement and equipment of the backplanes

The 4 backplanes must be arranged and fitted as illustrated in [Figure 5](#). The 3 backplanes must be arranged and fitted as illustrated in [Figure 6](#).

NOTICE

The IP65 protection rating is not guaranteed if the blanking plates are not screwed onto the electrical interfaces of the backplanes.

- ▶ Make sure that each of the blanking plates illustrated in [Figure 5](#) or in [Figure 6](#) is equipped with a seal.
- ▶ Make sure that the blanking plates illustrated in [Figure 5](#) or in [Figure 6](#) are screwed on the correct electrical interfaces of the backplanes.
- ▶ Tighten the blanking plates with a torque of 0.6 N·m (i. e. 0.44 ft·lbf).

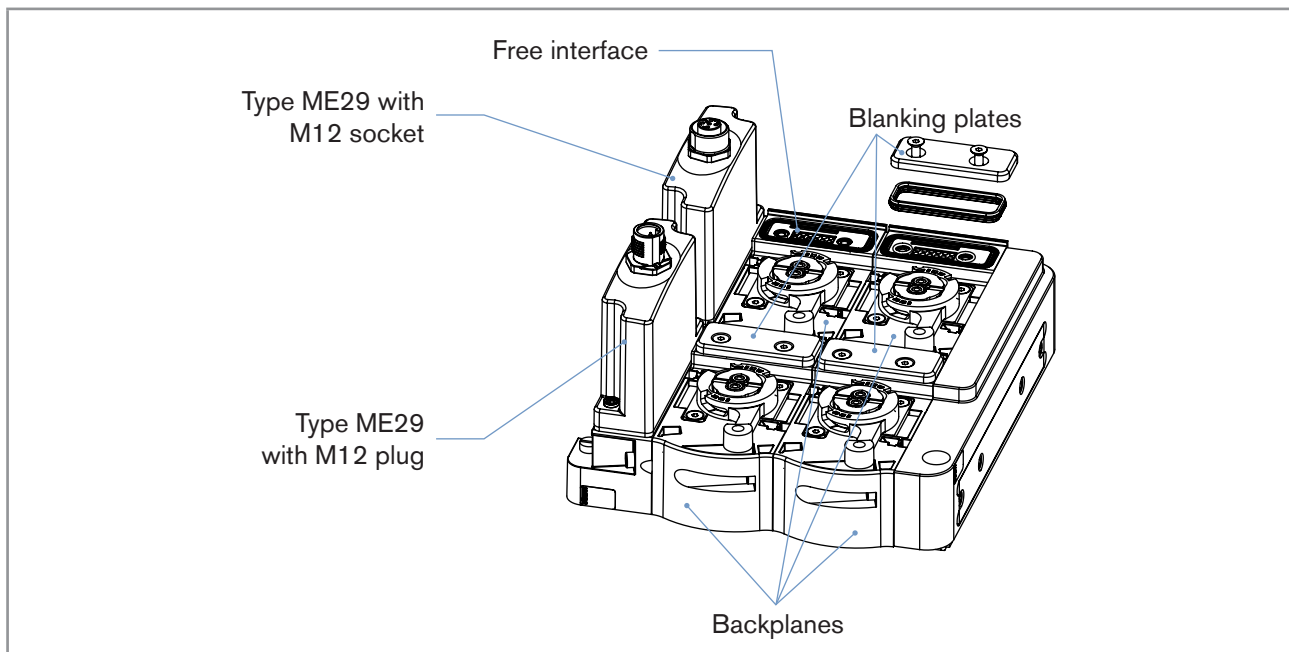

Figure 5: Backplanes for the product; arrangement and fitting of a 4 backplane combination

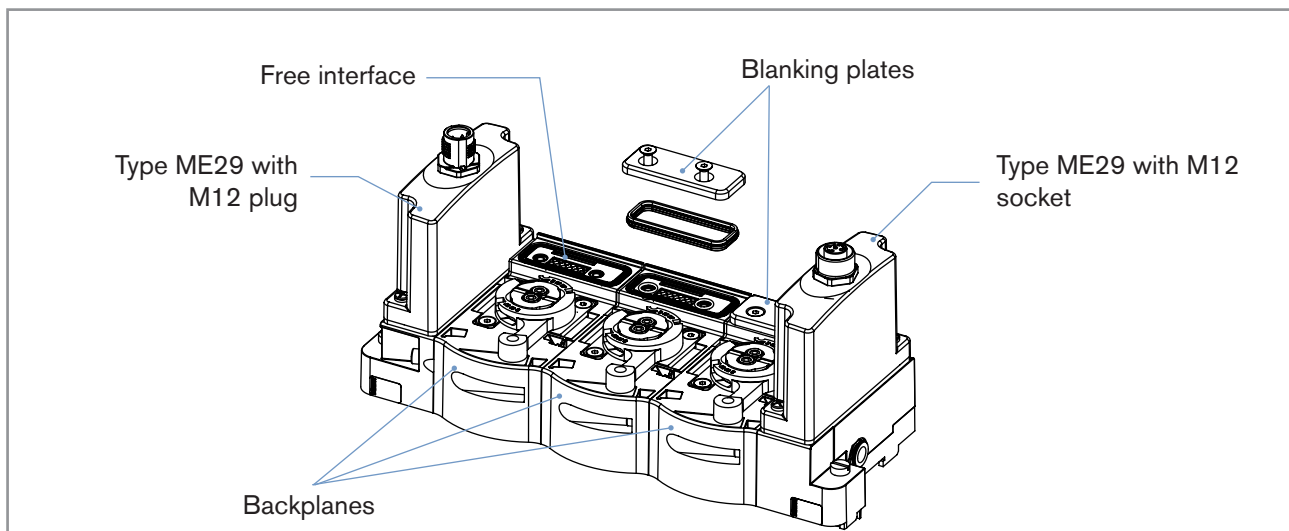

Figure 6: Backplanes for the product; arrangement and fitting of a 3 backplane combination

7.3.2 Mounting of the backplanes on 2 standard rails (TS35)

→ Fix the standard rails horizontally on a flat wall suitable for the installation.

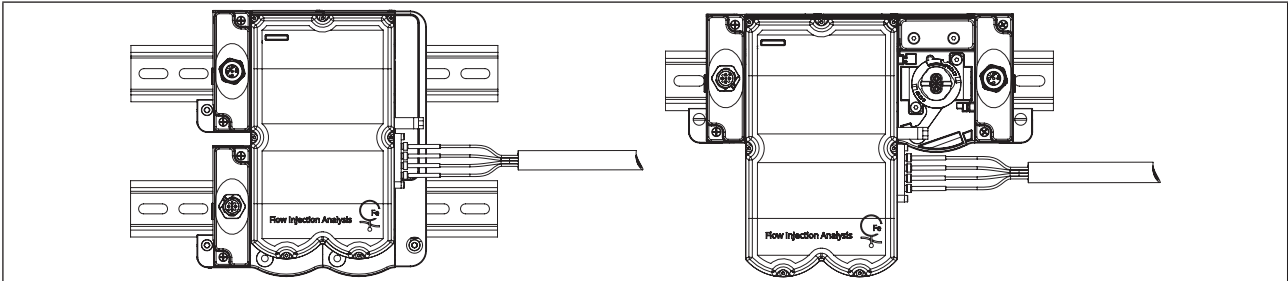

Figure 7: Wall mounting using two standard rails TS35

7.3.3 Mounting the product on a 4 backplane combination



The product creates air bubbles during sampling. Subsequent sensor cubes can be influenced by these.

- ▶ If the product is mounted on a 4 backplane combination and more than 4 backplanes are available, install the product as far to the **right** as possible.

	<ol style="list-style-type: none"> 1. Make sure that the seal is present on the product, on the electrical interface to the backplane. 2. Make sure that the four bayonet levers are in the closed position. 3. Make sure that the three blanking plates are protecting the electrical interfaces of the backplanes. 4. Dry the surface of the backplane. 5. Dry the surface of the product.
	<ol style="list-style-type: none"> 6. Make sure that a seal is present on each of the four fluidic interfaces with the tube module and that the tubes are empty. 7. Screw the tube module plug on to the product (torque 0.15 N·m, i. e. 0.11 ft·lbf). Do not kink or damage the tubes in the process. 8. Make sure that the product lever is against the stop in the unlocked position and that the bolts engage in the holes of the bayonet lever during mounting. 9. Insert the two adaptation pins in their holes and then plug the product in the backplane.

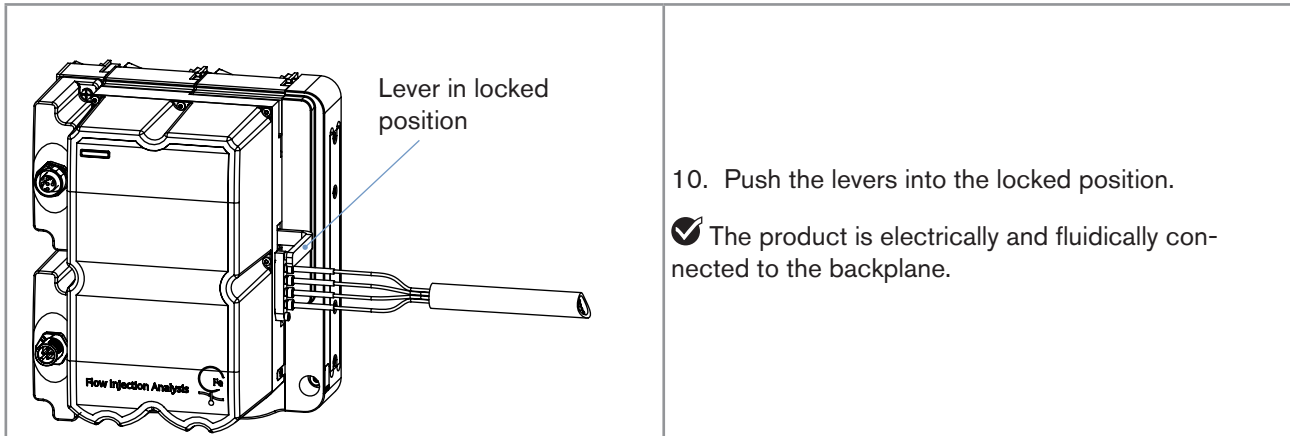

10. Push the levers into the locked position.

✔ The product is electrically and fluidically connected to the backplane.

Figure 8: Mounting the product on a 4 backplane combination

7.3.4 Mounting the product on a 3 backplane combination



The product creates air bubbles during sampling. Subsequent sensor cubes can be influenced by these.

► Mount the product downstream other sensor cubes.



If the product is mounted on a 3 backplane combination, install the product as far to the **left** as possible so that the lever can be unlocked.

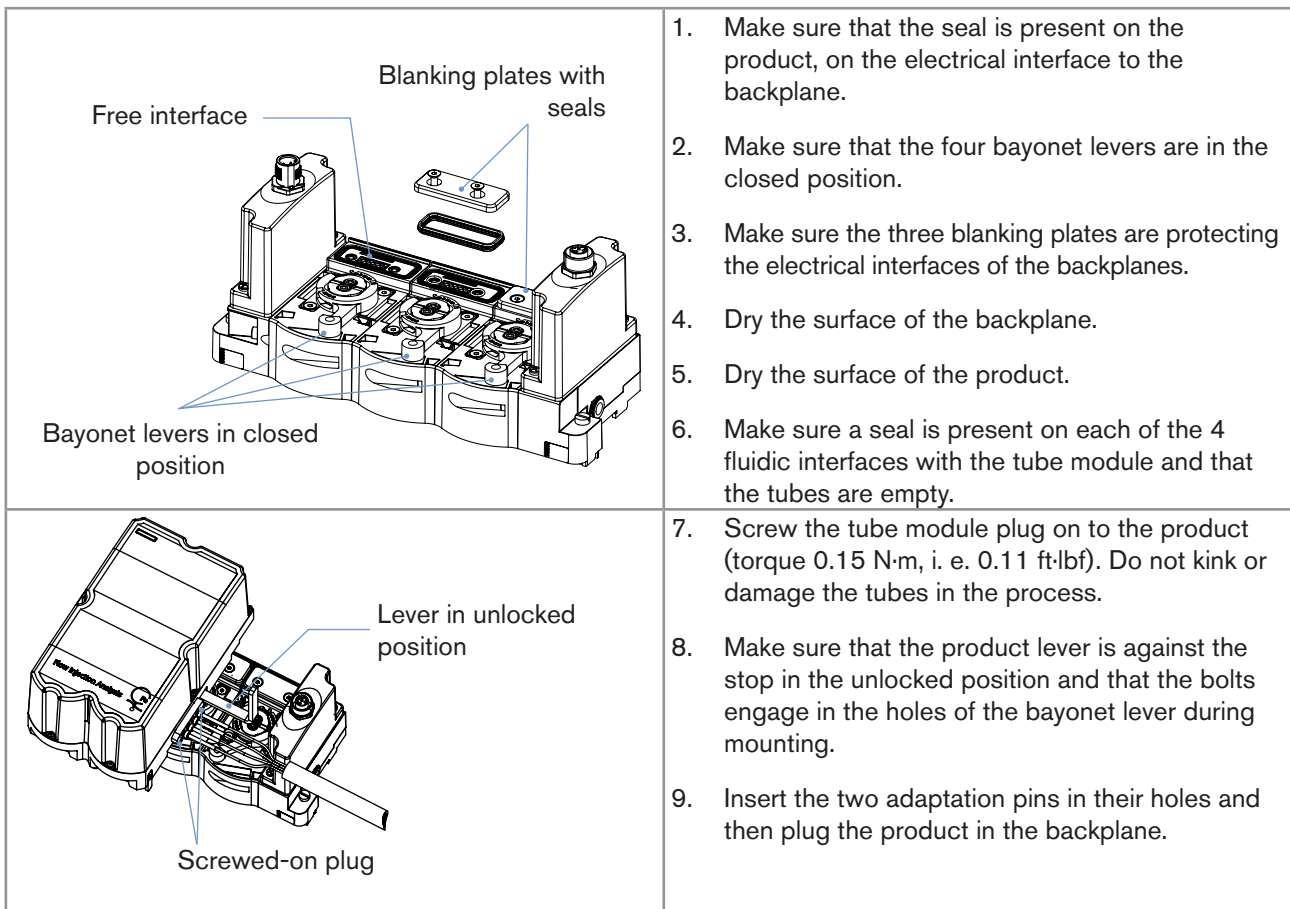

1. Make sure that the seal is present on the product, on the electrical interface to the backplane.
2. Make sure that the four bayonet levers are in the closed position.
3. Make sure the three blanking plates are protecting the electrical interfaces of the backplanes.
4. Dry the surface of the backplane.
5. Dry the surface of the product.
6. Make sure a seal is present on each of the 4 fluidic interfaces with the tube module and that the tubes are empty.
7. Screw the tube module plug on to the product (torque 0.15 N·m, i. e. 0.11 ft·lbf). Do not kink or damage the tubes in the process.
8. Make sure that the product lever is against the stop in the unlocked position and that the bolts engage in the holes of the bayonet lever during mounting.
9. Insert the two adaptation pins in their holes and then plug the product in the backplane.

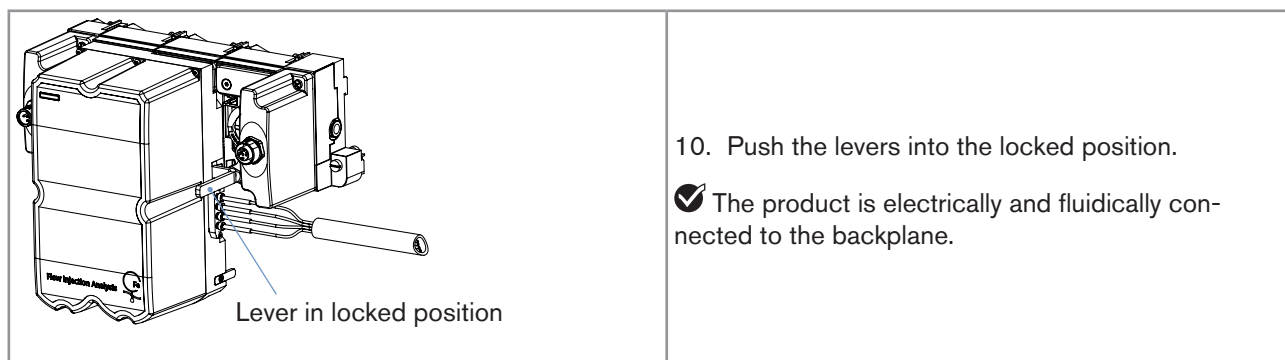

Figure 9: Mounting the product on a 3 backplane combination

7.3.5 Installation of the reagent unit

- Install the reagent unit so that the bottles are above the interface to MS06.
- Pay attention to the length (60 cm) of the tube module during installation of the reagent unit.
- Observe the instructions given in the Operating Instructions of the type MZ30, available at www.burkert.com.

7.4 Fluid system installation

7.4.1 Fluidic connection of the product with housing

- Observe the information in the Operating Instructions of the type 8905, available at www.burkert.com.
- Prepare a container with the following properties:
 - made from a material (e.g. polyethylene) which is resistant to the operating agents of the reagent unit.
 - has a minimum capacity of 2.5 litres. Enter the container capacity in the user interface, in order to generate warnings if the container needs to be emptied. See chap. [9.7.8 Monitoring the fill level of the waste container](#).
- Label the container as chemical waste.
- Secure the end of the waste tube, that is outside the system, in the container.

7.4.2 Fluidic connection of the product mounted on a standard rail

- If the product is mounted on the standard rail, connect the tube module of the reagent unit to the product.
- Connect the product to the sample water using 6-mm tubes, respecting the specified pressure and flow rate.
- Prepare a container with the following properties:
 - made from a material (e.g. polyethylene) which is resistant to the operating agents of the reagent unit.
 - has a minimum capacity of 2.5 litres. Enter the container capacity in the user interface, in order to generate warnings if the container needs to be emptied. See chap. [9.7.8 Monitoring the fill level of the waste container](#).
- Label the container as chemical waste.

- Stick the supplied labels with the hazardous material symbols onto the container.
- Secure the waste tube in the container.

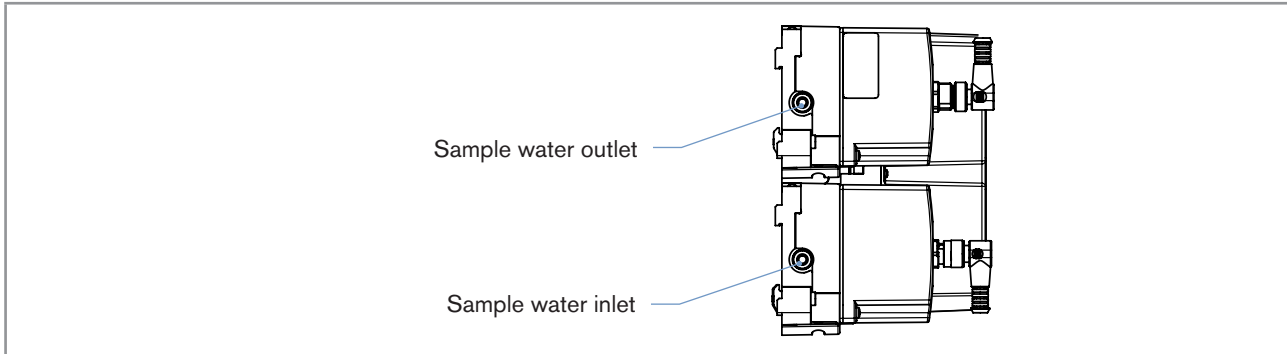

Figure 10: Fluidic connection of the product without housing

7.5 Electrical connection

7.5.1 Pin assignment for the M12 connectors

- The M12 plug is used to connect power supply and the fieldbus signals.
- The M12 socket is used for forwarding the voltage supply and fieldbus signals to an external device (e.g. reagent unit type MZ30 with electronics).

The pin assignment is the same for both M12 connections of the ME29 modules and for the M12 plug of the reagent unit.

Table 1: Pin assignment for the M12 connectors

Pin number	Signal	Wire colour (from housing with the cable coming from the electronics module)	
1	CAN_SHIELD	-	
2	24 V DC	Red	
3	0 V / GND	Black	
4	CAN_H	White	
5	CAN_L	Blue	

7.5.2 Connecting the product with housing to the power supply and fieldbus

- In order to operate the products via the Bürkert-Communicator, use the büS stick set with order code 00772426. This is available as an accessory.
- To operate the product via a display of type ME21:
 - Connect the M12 plug of the housing with the type MS06 via the cable gland plate on the terminal block of the housing to the display of type ME21 and the HMIU electronics module.

→ Connect the housing with the display of type ME21 and the HMIU electronics module to the power supply via the cable gland plate in accordance with the notes in the Operating Instructions of the type 8905.

The product with housing is connected to the reagent unit at the factory.

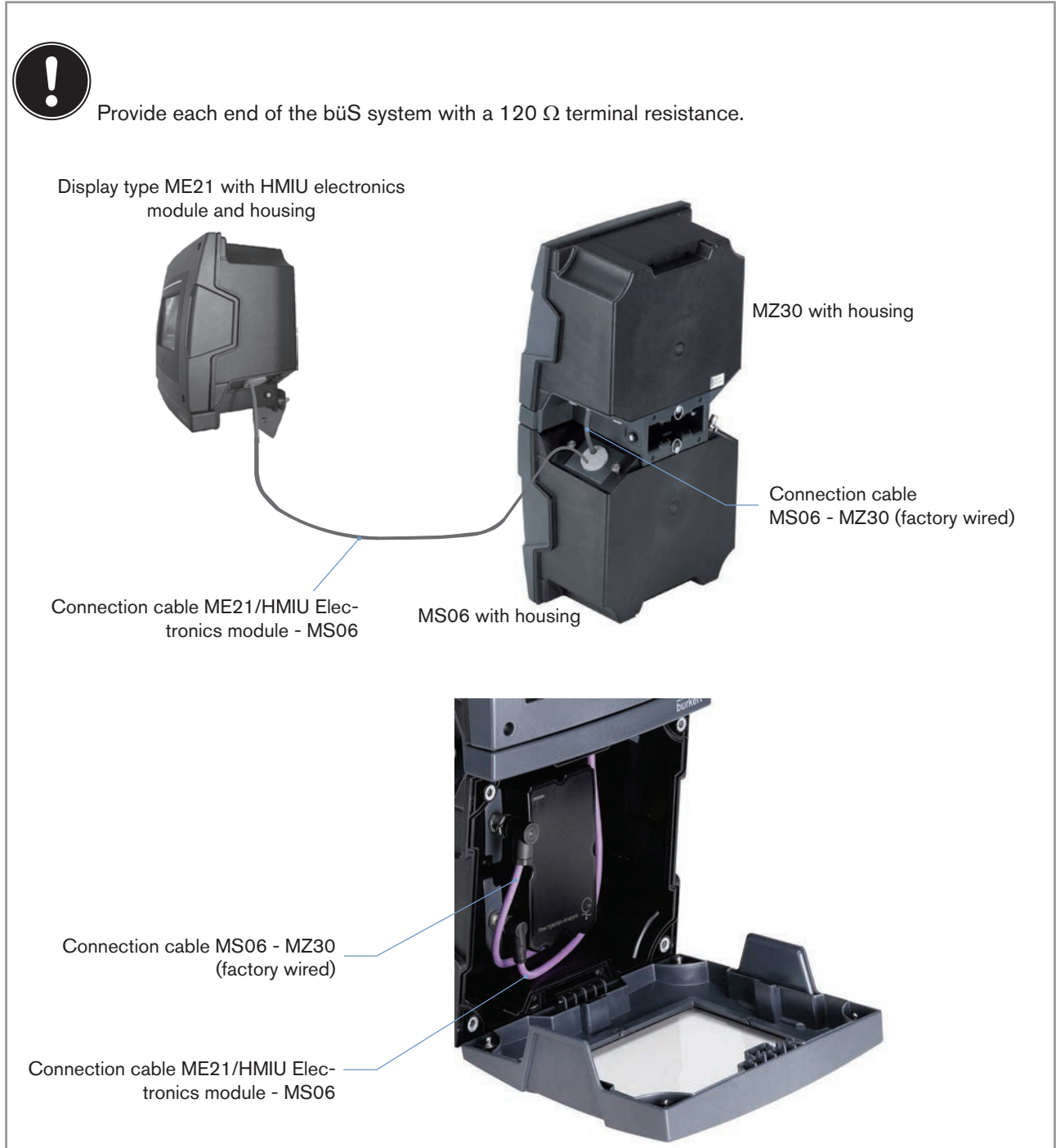

Figure 11: Connecting the housing with display and HMIU electronics module to MS06

7.5.3 Electrically connecting the product without housing

If the product without housing is operated via a display type ME21,

- Connect the housing with the display of type ME21 and the HMIU electronics module to the power supply via the cable gland plate in accordance with the notes in the Operating Instructions of the type 8905.
- Connect the M12 plug of the type ME29 to the terminal block of the housing with the display type ME21 and the HMIU electronics module via the cable gland plate.
- Only if a reagent unit type MZ30 with electronics is used, connect the M12 socket of the 2 type ME29s directly to the M12 plug of the reagent unit.

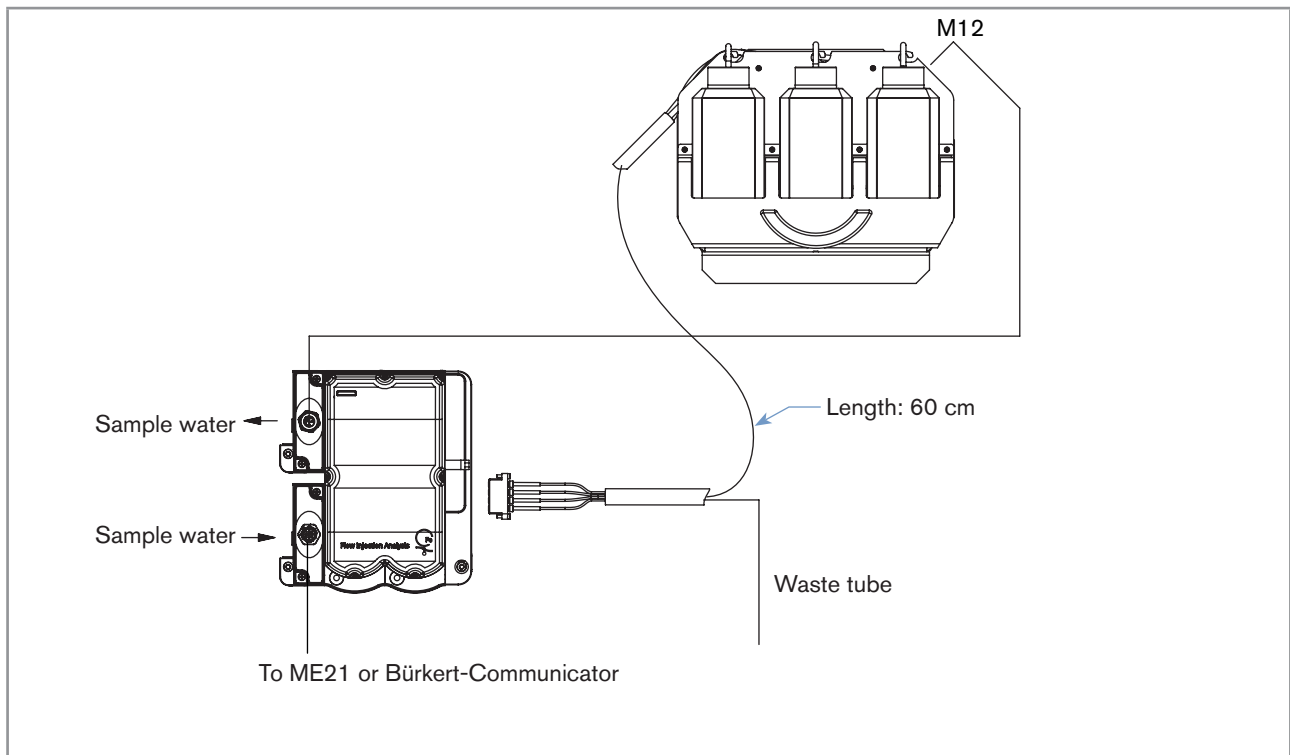

Figure 12: Electrical connection MS06 - MZ30, without housing, to ME21 or Bürkert-Communicator

8 COMMISSIONING

8.1 Safety instructions



DANGER

Danger due to the nature of the operating agents.

- ▶ Observe the rules in force concerning accident prevention and safety and which relate to the use of hazardous products.
- ▶ Observe the information in the safety data sheet. The safety data sheets can be found at
 - Reagent: <http://sds-id.com/200123-8>
 - Cleaning solution: <http://sds-id.com/200124-7>
 - Calibration solution: <http://sds-id.com/200122-9>
- ▶ Use a waste container of at least 2.5 litres.
- ▶ Dispose of waste containing chemicals produced by the system in an environmentally friendly manner.



NOTICE

Risk of damage to the product due to non-conforming commissioning.

- ▶ Staff in charge of adjustment must have read and understood the contents of the following Operating Instructions:
 - Display software Type ME21
 - Bürkert-Communicator software Type 8920
 - Controller Type ME25
- ▶ In particular, observe the safety recommendations and intended use.
- ▶ The product/system must only be operated by suitably trained staff.

8.2 Before commissioning the product



- Make sure that a waste container with a minimum capacity of 2.5 l is prepared.
- Make sure the fluidic and electrical connections have been made on the system:
 - tube module of the reagent unit to the product,
 - product to the backplane,
 - backplane to sample water,
 - waste tube to waste container,
 - fieldbus connection to display (or via the PC to the Bürkert-Communicator),
 - (Only if a reagent unit with electronics is used) fieldbus connection to reagent unit.
- Make sure that the pressure and flow conditions are within the specifications. Refer to the technical data.
- Make sure that each of the lines for reagent, cleaning solution and calibration solution is connected to the correct bottle of the reagent unit.
- (Only if a reagent unit with electronics is used) Make sure that the product is connected with the reagent unit via the software (see chap. [9.7.6](#)).
- Check the warning limits and error limits for monitoring the process variables, in the "Parameter" view of the product (see chap. [9.7](#)).

- Check if messages have been generated: The symbol  appears on the display. Tap  to access the "Message List": To solve the problems, refer to the chap. [10 Maintenance and troubleshooting](#) of these Operating Instructions and to the troubleshooting chapter of the Quickstart of the system.

8.3 Procedure for commissioning the product



This setting is possible from user level **Advanced user**.

1. Observe the instructions given in chap. [8.1 Safety instructions](#) and in chap. [8.2 Before commissioning the product](#).
2. Allow the sample to flow through the system.
3. In order to access the "Maintenance" view, tap  in the "Parameter" view of the FIA function.
4. Tap **Manual task** **None**  and select **Initialize System**.
5. Confirm.

 If no function is active, the commissioning will be performed. The device status **Initialisation** is displayed in the "Diagnosis" view and the "Maintenance" view of the product.

8.4 Procedure for commissioning after a flow interruption



Air in the fluidic parts of the product causes measurement errors.

Air can enter into the fluidic parts of the product if no fluid flows through the product but measurements are still made.

- If no fluid flows through the product, switch off the automatic analysis, calibrations and cleaning cycles. See chap. [9.9.4 Switching off automatic analyses, calibrations and cleaning cycles](#).
- Commission the product as described in chap. [8.3](#).

9 ADJUSTMENT AND OPERATION

9.1 Safety instructions



DANGER

Danger due to the nature of the operating agents.

- ▶ Observe the rules in force concerning accident prevention and safety and which relate to the use of hazardous products.
- ▶ Observe the information in the safety data sheet. The safety data sheets can be found at
 - Reagent: <http://sds-id.com/200123-8>
 - Cleaning solution: <http://sds-id.com/200124-7>
 - Calibration solution: <http://sds-id.com/200122-9>
- ▶ Use a waste container of at least 2.5 litres.
- ▶ Dispose of waste containing chemicals produced by the system in an environmentally friendly manner.

NOTICE

Risk of damage to the product due to non-conforming adjustment and in operation.

- ▶ Staff in charge of adjustment must have read and understood the contents of the following Operating Instructions:
 - Display software Type ME21
 - Bürkert-Communicator software Type 8920
 - Controller Type ME25
- ▶ In particular, observe the safety recommendations and intended use.
- ▶ The product/system must only be operated by suitably trained staff.

9.2 How to adjust the product

The adjustment of the product can be made:

- either with the display of the system type 8905. The display of the system is managed by the software type ME21. See chap. [9.3](#).
- or with a PC and the Bürkert-Communicator software type 8920. To get general information about the software type 8920, refer to the Operating Instructions of the type 8920.

9.3 General information on the display software type ME21

These Operating Instructions explain the adjustments that are specific to the flow injection analysis sensor cube type MS06.

- To get general information about the display software type ME21, refer to the Operating Instructions of the type ME21 that is on the CD delivered with the system and that is also available at www.burkert.com.

The Operating Instructions of the display software type ME21:

- give general information on the software, such as: description of the user interface, structure of the menus, description of the possible views ("Device" view for example), description of the navigation buttons...
- explain how to make the general adjustments such as: the display language, the locating of the product...
- explain how to configure and customize the "Desktop" views with values or graphs.
- give general information on the error messages and the operating of the system status light.

9.4 "Device" view of the product

The "Device" view shows some of the measurement data related to the product.



→ If the display shows a "Desktop" view, tap  to access the "Device" view.

→ To display the "Device" view of the product, select the product in the list of devices on the left of the display.

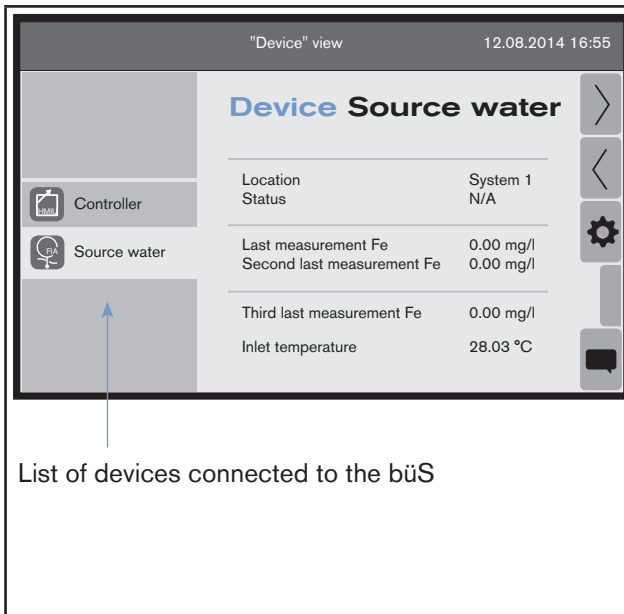

List of devices connected to the büS

The following data can be read in the "Device" view of the product:

- The devices connected to the büS and their description can be read or edited in the büS "Function" view. For example, "Source water"; the standard value, independent of the display language, for the description of a sensor cube in accordance with the flow injection analysis principle is "FIA Iron".
- Location of the product.
- The last 3 measured values of the proportion of dissolved iron.
- The measured inlet temperature of the sample.

Table 2: "Device" view of the product



→ To display the "Function" view of the product, tap .

9.5 "Function" view of the product

The "Function" view shows the functions available for a product and, for each function, the main data related to each function.

To display the "Function" view of the product:

1. select the product in the list of devices, on the left of the display,



2. tap .





	<p>"Function" view of the büS</p> <p>→ To display the "Function" view of the büS that the product is connected to, select "büS" in the list of devices on the left of the display.</p> <p>→ Tap  to access the "Parameter" view. See chap. 9.6.</p>
	<p>"Function" view of the product</p> <p>→ To display the "Function" view of the product, select FIA in the list of devices on the left of the display.</p> <p>The following data can be read in the "Function" view of the sensor:</p> <ul style="list-style-type: none"> ▪ The last measured value of the proportion of dissolved iron. ▪ The measured inlet temperature of the sample. ▪ The measured outlet temperature of the sample. ▪ The baseline value of the measured photometer signal. ▪ The value of the peak height of the last measured signal. <p>→ Tap  to access the "Parameter" view. See chap. 9.7.</p>

Table 3: "Function" views of the product

9.6 Detailed views of the büS function

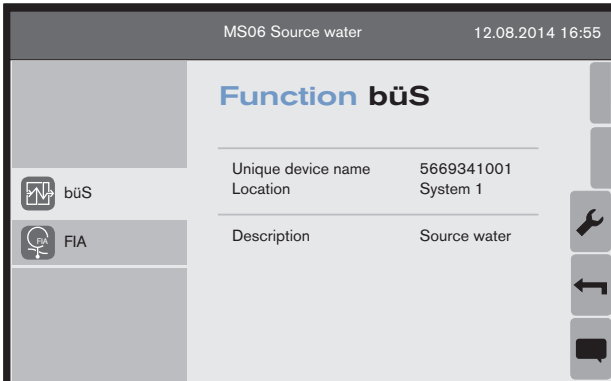

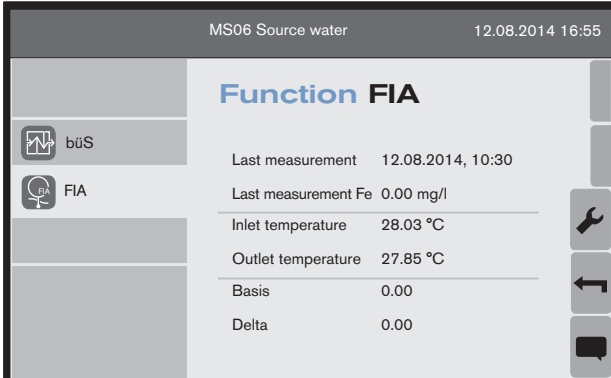
"Parameter" detailed view of the büS

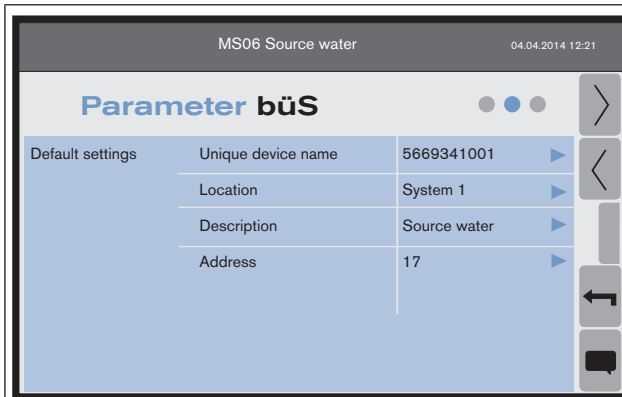
- **Unique device name** is used by the items connected on the büS (including the display). If the **Unique device name** is changed, the items lose the link with the product. Only a user with Installer access rights can modify the **Unique device name**. **Unique device name** should only be changed if two products connected on the büS have the same name (for example two sensors with the name "5669341001").

→ In this case, select a name for **Unique device name**, which explicitly identifies the product, because if **Unique device name** is changed, all of the büS parameters must be modified.

- **Location** is used to locate the product geographically.
- **Address** of the CANopen node.

The **Description** parameter (**FIA Iron** as the default setting) is used to identify the product in the system. The description is displayed:

- in the list of devices, next to the symbol corresponding to the product,
- in the header of each detailed view of the product, next to the device name,
- and in the custom views.

Table 4: "Parameter" view of the "büS" function

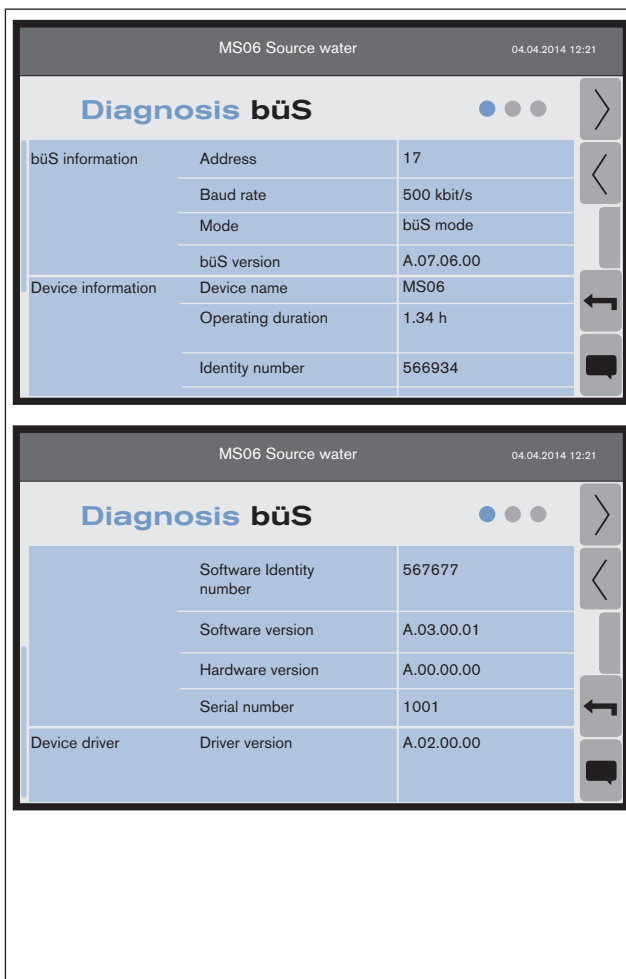

"Diagnosis" detailed view of the büS

Read only fields, whatever the user level.

Information about the büS:

- **Address** of the CANopen node.
- **Baud rate** for information transmitted via the büS.
- **Mode** of operation of the fieldbus.
- **büS version**

Information about the product:

- **Device name**
- **Operating time** indicates the number of operating hours of the product
- **Ident number**: product order code.
- **Software Ident number**: order code for the software installed on the product.
- **Software version**: version of the software installed on the product.
- **Hardware version**: hardware version of the product.
- **Serial number**: serial number of the product.
- **Driver version**: installed on the product.

Table 5: "Diagnosis" view of the "büS" function

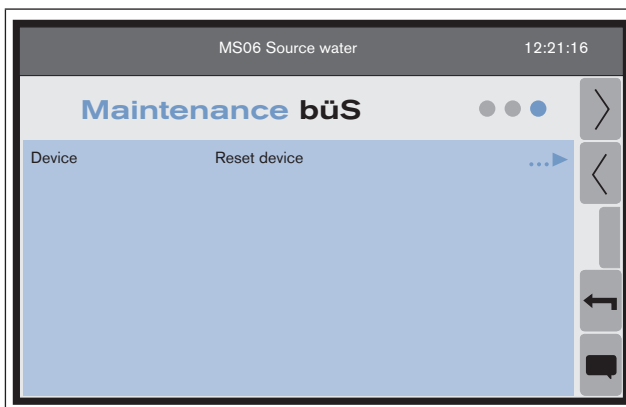

"Maintenance" detailed view of the büS

This function is accessed from the **Advanced user** level.

Used to restart the product.

Table 6: "Maintenance" view of the "büS" function

9.7 Setting the parameters of function FIA

9.7.1 Functions that can be adjusted in "Parameter" view

→ In the FIA "Function" view, tap  to access the "Parameter" view.



	<p>The "Parameter" view, makes it possible to</p> <ul style="list-style-type: none"> ▪ set the time interval between 2 analyses. See chap. 9.7.2. ▪ set a value defining the number of analyses after which a calibration is automatically performed. See chap. 9.7.3. ▪ set a value defining the number of analyses, after which a cleaning cycle is automatically performed. See chap. 9.7.4. ▪ read and, if necessary, modify the calibration value. See chap. 9.7.5. ▪ set automatic monitoring of the operating agents. See chap. 9.7.6. ▪ monitor the fill level of the waste container. See chap. 9.7.8. ▪ switch off the monitoring of the fill level of the waste container. See chap. 9.7.9. ▪ monitor the expiration date of the operating agents. See chap. 9.7.11. ▪ monitor the measured value by triggering a warning message or error message. See chap. 9.7.12.
	

Table 7: "Parameter" view of the "FIA" function

9.7.2 Setting the time interval between 2 analyses

 This setting is available from user level **Installer**.

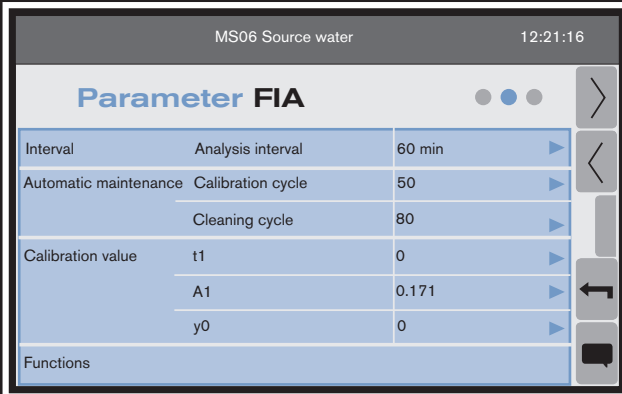
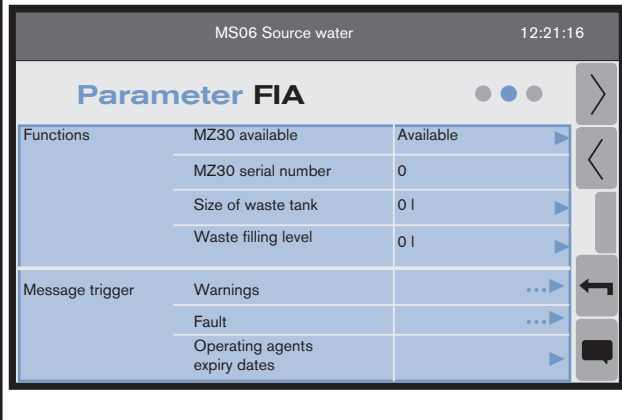
If the product is desired to start the analyses automatically, the time interval between 2 analysis can be set.

An analysis to determine the iron content in the sample water takes 25 minutes with the default settings. The smallest time interval between 2 analysis is 1 minute, the largest interval is 1440 minutes (24 hours).

Procedure for setting the time interval between two analyses:

1. In the "Parameter" view for function FIA, tap **Interval** **Analysis interval** .
2. Enter the time interval.
3. Confirm.

 The time interval is set.

→ To start the analyses automatically, refer to chap. [9.9.3](#).

9.7.3 Setting the automatic start of a calibration

 This setting is possible from user level **Advanced user**.

To calibrate the product connected according to chap. [7 Installation](#).

Perform the calibration of the product regularly, depending on the quality of the water

The calibration can

- either be started manually via the "Maintenance" view of the product: See chap. [9.9.7](#).
- or be started automatically after a set number of analyses.

Procedure for setting automatic start of a calibration:

1. In the "Parameter" view for function FIA, tap **Automated maintenance Calibration cycle** ▶.
2. Enter the number of analyses after which a calibration is to start automatically.
3. Confirm.
4. Start the automatic analyses, calibrations and/or cleaning cycles. See chap. [9.9.3](#).

 A calibration will be automatically started after the set number of analyses.

9.7.4 Setting the automatic start of a cleaning cycle

 This setting is possible from user level **Advanced user**.

To clean the fluid system of the product connected according to chap. [7 Installation](#).

A cleaning cycle of the product should be performed regularly, depending on the quality of the water.

The cleaning cycle can

- either be started manually via the "Maintenance" view of the product: see chap. [9.9.8](#).
- or be started automatically after a set number of analyses.

Procedure for setting automatic start of a cleaning cycle:

1. In the "Parameter" view for function FIA, tap **Automatic maintenance Cleaning cycle** ▶.
2. Enter the number of analyses after which a cleaning cycle is to start automatically.
3. Confirm.
4. Start the automatic analyses, calibrations and/or cleaning cycles. See chap. [9.9.3](#).

 A cleaning cycle will be automatically started after the set number of analyses.

9.7.5 Manually modifying the calibration values

 This setting is available from user level **Installer**.

The calibration values (t1, A1 and y0) are determined through calibration of the product.

Procedure for modifying the calibration values:

1. In the "Parameter" view for function FIA, tap **Calibration values t1** ▶ or **Calibration values A1** ▶ or **Calibration values y0** ▶.
2. Edit the value.
3. Confirm.

 The calibration values are changed.

9.7.6 Connecting the product with the reagent unit to monitor the operating agents (only MZ30 with electronics)

 Before commissioning, connect the product to the reagent unit via the software.

 This setting is possible from user level **Advanced user**.

If the product and the reagent unit (MZ30 with electronics) are connected, monitoring of the operating agents can occur automatically via the reagent unit.

The product receives data concerning the type, shelf-life and fill level of the operating agents from the reagent unit.

Procedure for setting automatic monitoring of the operating agents:

1. In the "Parameter" view for function FIA, tap **MZ30 available Not available** ▶.
2. Select **Available**.
3. Confirm.
4. Tap **MZ30 Serial No.** ▶.
5. Enter the serial number of the reagent unit used. The serial number can be read on the nameplate of the reagent unit and in the "Parameter" view of the reagent unit.
6. Confirm.
7. Restart the product.

 The connection between the product and the reagent unit (MZ30 with electronics), as well as automatic monitoring of the operating agents are set.

 If the fill level of an operating agent is between 10 and 20%, a warning message is generated.

 If the fill level of an operating agent is below 10%, an error message is generated.

9.7.7 Monitoring the fill level of the operating agents, MZ30 without electronics

If a reagent unit type MZ30 without electronics is used, the fill level of the operating agents is calculated from the volume that has been pumped.

- ✔ If the fill level of an operating agent is between 10 and 20%, a warning message is generated.
- ✔ If the fill level of an operating agent is below 10%, an error message is generated.

9.7.8 Monitoring the fill level of the waste container



This setting is possible from user level **Advanced user**.

You can automatically:

- receive a warning message when the waste container is 80% full,
- receive an error message when the waste container is 95% full,

Procedure for monitoring the fill level of the waste container:

1. In the "Parameter" view for function FIA, tap **Size of waste tank** ▶.
2. Enter the capacity of the waste container.
3. Confirm.
4. Tap **Waste filling level** ▶.
5. Enter the current fill level of the waste container.
6. Confirm.

- ✔ Monitoring of the fill level of the waste container is set.

9.7.9 Switching off the monitoring of the fill level of the waste container



This setting is possible from user level **Advanced user**.

Procedure for switching off automatic monitoring of the fill level of the waste container:

1. In the "Parameter" view for function FIA, tap **Size of waste tank** ▶.
2. Enter 0.
3. Confirm.

- ✔ Monitoring of the fill level of the waste container is switched off.

9.7.10 Setting the fill level of the waste container to zero

In order for waste container fill level monitoring to be performed correctly, the fill level must be set to zero after emptying the waste container.

1. In the "Parameter" view for function FIA, tap **Waste filling level** ▶.
2. Enter 0.
3. Confirm.

✔ The fill level of the waste container is set to zero.

9.7.11 Monitoring the expiration date of the operating agents (only MZ30 with electronics)



This setting is possible from user level **Advanced user**.

The operating agents have a limited shelf life. You can be warned automatically before the expiration date.

Procedure for monitoring the expiration date of the operating agents

1. In the "Parameter" view for function FIA, tap **Operating agents expiry dates** ▶.
2. Enter the number of days before the expiration date at which a warning message should be generated.
3. Confirm.

✔ Monitoring of the expiration date of the operating agents is set.

9.7.12 Monitoring the iron content



This setting is possible from user level **Advanced user**.

The iron content can be monitored in order to detect problems in the process.

Two maximum values can be set for the iron content:

- The upper warning limit. If this maximum value is reached, a warning message is created.
- The upper error limit. If this maximum value is reached, an error message is created. The product continues to measure. However, the values are not displayed or exported, for as long as the error is active.

If the configured maximum value is reached and the corresponding activation flag is selected, an error message or warning message is generated in the message list: To access the message list, tap . See chap. [10 Maintenance and troubleshooting](#) for troubleshooting details.

Procedure for activating the triggering of a warning message:

1. In the "Parameter" view for function FIA, tap **Messages trigger** **Warnings** ...▶
2. **Tap Warning triggers** **Measured value upper limit** ▶ and enter the maximum limit value for the iron content, for which a warning message will be created.
3. Confirm.
4. **Tap Warning triggers** **Activation flags** ▶ and select **Measured value upper limit**.

5. Confirm.

Procedure for activating the triggering of an error message:

1. Tap **Messages trigger** **Errors** ...▶ in the "Parameter" view of the function FIA.
2. Tap **Error triggers** **Measured value upper limit** ▶ and enter the maximum limit value for the iron content, for which an error message will be created.
3. Confirm.
4. Tap **Error triggers** **Activation flag** ▶ and select **Measured value upper limit**.
5. Confirm.

✔ Iron content monitoring is set.

9.8 Reading the product diagnosis

9.8.1 Reading the current product status

→ In order to access the "Diagnosis" view, tap  in the "Parameter" view of the FIA function.

→ Read the **Device status**.

Function in progress	Displayed device status
None	Idle
Analysis	Analysis
Calibration	Calibration
Cleaning	Cleaning
Degassing	Degassing
Filling sample tube	Fill probe tube
Filling reagent tube	Fill REAGENT tube
Filling calibration tube	Fill CALIB. tube
Filling cleaning tube	Fill CLEANING tube
Commissioning	Initialisation
Draining reagent tube	Drain REAGENT tube
Draining calibration tube	Drain CALIB. tube
Draining the cleaning tube	Drain CLEANING tube

Table 8: Device status display

9.8.2 Reading the total operating time of the product

→ In order to access the "Diagnosis" view, tap  in the "Parameter" view of the FIA function.

→ Read the total operating time in menu item **Operating hours**.

9.8.3 Reading the number of analyses since first commissioning

- In order to access the "Diagnosis" view, tap  in the "Parameter" view of the FIA function.
- Read the number of analyses, since first commissioning in menu item **Analyses, total**.

9.8.4 Reading the number of analyses before the next automatic calibration

- In order to access the "Diagnosis" view, tap  in the "Parameter" view of the FIA function.
- Read the number of analyses before the next calibration in menu item **Next calibration**. An automatic calibration is started as soon as the value reaches zero.

9.8.5 Reading the number of analyses before the next automatic cleaning

- In order to access the "Diagnosis" view, tap  in the "Parameter" view of the FIA function.
- Read the number of analyses before the next cleaning in menu item **Next cleaning**. An automatic cleaning is started as soon as the value reaches zero.

9.8.6 Reading the connection status between the product and reagent unit

- In order to access the "Diagnosis" view, tap  in the "Parameter" view of the FIA function.
- Read the status of the connection between the product and a reagent unit in menu item **MZ30 status**. Possible values: **Connected** or **Not found**.
- If a reagent unit without electronics is used, **Not found** is displayed.
- If a reagent unit with electronics is used, but **Not found** is displayed, make sure the serial number of the reagent unit has been correctly entered. See chap. [9.7.6](#). Also check all the bÜS connections.

9.9 Setting maintenance work

→ In the "Parameter" view of the function FIA, tap  to access the "Maintenance" view.

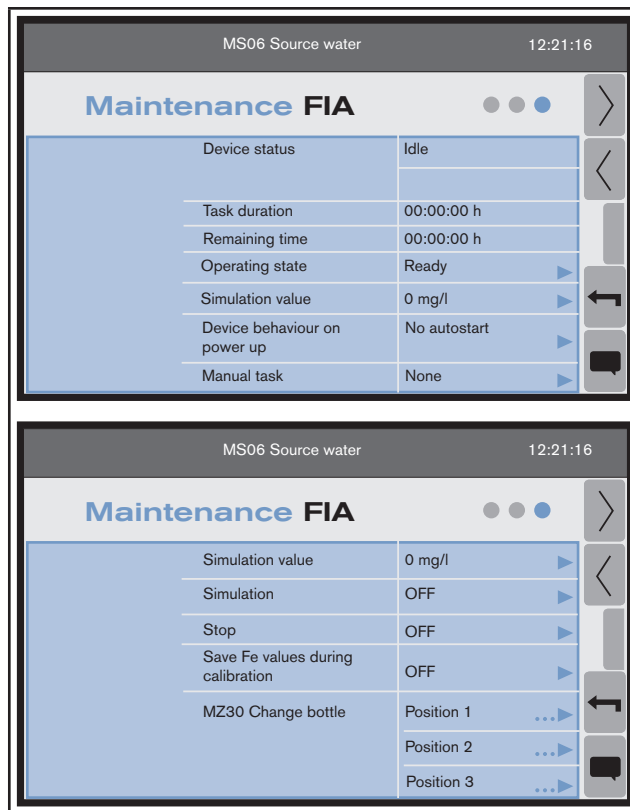

MS06 Source water		12:21:16
Maintenance FIA		
Device status	Idle	
Task duration	00:00:00 h	
Remaining time	00:00:00 h	
Operating state	Ready	
Simulation value	0 mg/l	
Device behaviour on power up	No autostart	
Manual task	None	

MS06 Source water		12:21:16
Maintenance FIA		
Simulation value	0 mg/l	
Simulation	OFF	
Stop	OFF	
Save Fe values during calibration	OFF	
MZ30 Change bottle	Position 1	...
	Position 2	...
	Position 3	...

The "Maintenance" view of the product makes it possible to

- track the progress of a function in progress. See chap. [9.9.1](#).
- read the total and remaining time of a function in progress. See chap. [9.9.2](#).
- start automatic analyses, calibrations and cleaning cycles. See chap. [9.9.3](#).
- set the behaviour of the product after a power interruption. See chap. [9.9.5](#).
- manually start a function (analysis, calibration, cleaning, etc.). See chap. [9.9.6](#) to chap. [9.9.17](#).
- simulate a measurement value. See chap. [9.9.18](#).
- freeze the last measured value. See chap. [9.9.19](#).
- switch on and off the memory of the iron content measured during the calibration. See chap. [9.9.20](#) and chap. [9.9.21](#).
- perform a stepwise change of the bottles of the reagent unit. See chap. [9.9.22](#).

Table 9: "Maintenance" view of the "FIA" function

9.9.1 Reading the current function and tracking its progress

If a function is active, its progress is displayed. This affects the following functions:

- An active analysis, calibration or cleaning, whether automatic or started via the submenu **Manual task**,
- or any function activated in the submenu **Manual task**.

Procedure for tracking the progress of a function in progress:

1. In order to access the "Maintenance" view, tap  in the "Parameter" view of the FIA function.
2. Read the current function and its progress in the menu item **Device status**. See [Table 10](#).

The progress is displayed with a bar (| ----- |).

Function in progress	Displayed device status
None	Idle
Analysis	Analysis
Calibration	Calibration
Cleaning	Cleaning
Degassing	Degassing
Filling sample tube	Fill probe tube
Filling reagent tube	Fill REAGENT tube
Filling calibration tube	Fill CALIB. tube
Filling cleaning tube	Fill CLEANING tube
Commissioning	Initialisation
Draining reagent tube	Drain REAGENT tube
Draining calibration tube	Drain CALIB. tube
Draining the cleaning tube	Drain CLEANING tube

Table 10: Device status display

9.9.2 Reading the total and remaining time of a function in progress

For a function in progress, the total and remaining time are displayed. This affects the following functions:

- An active analysis, calibration or cleaning, whether automatic or started via the submenu **Manual task**,
- or any function activated in the submenu **Manual task**.

Procedure for reading the total and remaining time of a function in progress:



1. In order to access the "Maintenance" view, tap  in the "Parameter" view of the FIA function.
2. Read the total time in menu item **Task duration**.
3. Read the remaining time in menu item **Remaining time**.

9.9.3 Starting automatic analyses, calibrations and cleaning cycles



This setting is possible from user level **Advanced user**.

Procedure for switching on automatic analyses, calibrations and cleaning cycles:

1. Set the time interval between 2 analysis, in accordance with chap. 9.7.2.
2. Set the automatic start of a calibration in accordance with chap. 9.7.3.
3. Set the automatic start of a cleaning cycle in accordance with chap. 9.7.4.
4. In order to access the "Maintenance" view, tap  in the "Parameter" view of the FIA function.
5. Tap **Operating state** **standby**  and select **Operating**.

6. Confirm.

✓ The first analysis for measuring iron content starts if no other function is active. The device status **Analysis** is displayed in the "Diagnosis" view and the "Maintenance" view of the product.



✓ The first calibration or cleaning cycle starts after the set number of analyses has been made.

9.9.4 Switching off automatic analyses, calibrations and cleaning cycles



This setting is possible from user level **Advanced user**.

Procedure for switching off automatic analyses, calibrations and cleaning cycles:

1. In order to access the "Maintenance" view, tap  in the "Parameter" view of the FIA function.
 2. Tap **Operating state** **Operating**  and select **standby**.
 3. Confirm.
- ✓ Automatic analyses, calibrations and cleaning cycles are switched off. The current analysis will be completed.



9.9.5 Setting the behaviour of the product after a power interruption



This setting is possible from user level **Advanced user**.

After a power interruption, the product can either remain in **Idle** status or perform further automatic analyses.

Procedure for behaviour of the product after a power interruption:

1. In order to access the "Maintenance" view, tap  in the "Parameter" view of the FIA function.
 2. In order that the product remains in **Idle** status after a power interruption, tap **Behavior at device start up** **Autostart**  and select **No autostart**.
 3. Confirm.
 4. In order that the product again performs automatic analysis after a power interruption, tap **Behavior at device start up** **No autostart**  and select **Autostart**.
 5. Confirm.
- ✓ The behaviour of the product after a power interruption is set.

9.9.6 Manually starting an analysis





This setting is possible from user level **Advanced user**.

The analysis is used to determine the iron content in the sample water. The analyses can be either:

- started automatically. The frequency of analysis is determined in chap. [9.7.2 Setting the time interval between 2 analyses](#). See chap. [9.9.3](#).
- or started manually.

Procedure for manually starting an analysis:

1. In order to access the "Maintenance" view, tap  in the "Parameter" view of the FIA function.
2. Switch off the automatic analyses, calibrations and cleaning cycles. See chap. [9.9.4](#).
3. Tap **Manual task** **None**  and select **Analysis**.
4. Confirm.

 The analysis for measuring iron content starts if no other function is active. The measured value is stored in the datalogger and displayed. See the Operating Instructions of the Controller module type ME25 at www.burkert.com. The device status **Analysis** is displayed in the "Diagnosis" view and the "Maintenance" view of the product.

9.9.7 Manually starting a calibration





This setting is possible from user level **Advanced user**.

→ To calibrate the product connect it according to chap. [7 Installation](#).

The calibration of the product can either be carried out automatically after a specified number of analyses or it can be started manually.

Procedure for manually starting a calibration:

1. In order to access the "Maintenance" view, tap  in the "Parameter" view of the FIA function.
2. Switch off the automatic analyses, calibrations and cleaning cycles. See chap. [9.9.4](#).
3. Tap **Manual task** **None**  and select **Calibration**.
4. Confirm.

 The calibration starts provided no other function is active. The device status **Calibration** is displayed in the "Diagnosis" view and the "Maintenance" view of the product.

9.9.8 Manually starting a cleaning cycle



This setting is possible from user level **Advanced user**.



To clean the analysis fluid system of the product, connect it according to chap. [7 Installation](#).

Perform the cleaning cycle of the analysis fluid system of the product regularly, depending on the quality of the water. The sample chamber and degassing unit are not cleaned.

The cleaning cycle can:

- either be started manually via the "Maintenance" view of the product.
- or be started automatically after a set number of analyses. See chap. [9.7.4](#).

Procedure for manually starting a cleaning cycle:

1. In order to access the "Maintenance" view, tap  in the "Parameter" view of the FIA function.
2. Switch off the automatic analyses, calibrations and cleaning cycles. See chap. [9.9.4](#).
3. Tap **Manual task** **None**  and select **Cleaning**.
4. Confirm.

 The cleaning of the product starts provided no other function is active. The device status **Cleaning** is displayed in the "Diagnosis" view and the "Maintenance" view of the product.



9.9.9 Manually starting degassing



This setting is possible from user level **Advanced user**.

Degassing is used to remove air from the fluid system of the product. Degassing is automatically performed before each analysis.

Degassing can be started manually if air has entered the product.



1. In order to access the "Maintenance" view, tap  in the "Parameter" view of the FIA function.
2. Switch off the automatic analyses, calibrations and cleaning cycles. See chap. [9.9.4](#).
3. Tap **Manual task** **None**  and select **Degassing**.
4. Confirm.

 Degassing starts provided no other function is active. The device status **Degassing** is displayed in the "Diagnosis" view and the "Maintenance" view of the product.

9.9.10 Manually starting filling of the sample fluid system

 This setting is possible from user level **Advanced user**.

Filling of the sample chamber and the sample fluid system can be started manually.

1. Make sure that sample water is flowing through the product.
2. In order to access the "Maintenance" view, tap  in the "Parameter" view of the FIA function.
3. Switch off the automatic analyses, calibrations and cleaning cycles. See chap. 9.9.4.
4. Tap **Manual task** **None**  and select **Fill probe tube**.
5. Confirm.

 The sample chamber will be filled provided no other function is active. The device status **Fill probe tube** is displayed in the "Diagnosis" view and the "Maintenance" view of the product.



9.9.11 Manually starting filling of the reagent tube

 This setting is possible from user level **Advanced user**.

The reagent tube must be refilled with reagent after changing the bottle.

Filling of the reagent tube occurs automatically in the last step of the function **MZ30 Change bottle Position 1**. See chap. 9.9.22 Step-by-step replacement of operating agent bottles.

Filling of the reagent tube can be started manually.

1. Make sure that the end of the tube has been immersed in reagent solution inside the reagent bottle.
2. In order to access the "Maintenance" view, tap  in the "Parameter" view of the FIA function.
3. Switch off the automatic analyses, calibrations and cleaning cycles. See chap. 9.9.4.
4. Tap **Manual task** **None**  and select **Fill REAGENT tube**.
5. Confirm.

 The reagent tube will be filled provided no other function is active. The device status **Fill REAGENT tube** is displayed in the "Diagnosis" view and the "Maintenance" view of the product.



9.9.12 Manually starting filling of the calibration tube

 This setting is possible from user level **Advanced user**.

The calibration tube must be refilled with calibration solution after changing the bottle.

Filling of the calibration tube occurs automatically in the last step of the function **MZ30 Change bottle Position 3**. See chap. 9.9.22 Step-by-step replacement of operating agent bottles.

Filling of the calibration tube can be started manually.

1. Make sure that the end of the tube has been immersed in calibration solution inside the calibration bottle.
2. In order to access the "Maintenance" view, tap  in the "Parameter" view of the FIA function.
3. Switch off the automatic analyses, calibrations and cleaning cycles. See chap. [9.9.4](#).
4. Tap **Manual task** **None**  and select **Fill CALIB. tube**.
5. Confirm.



 The calibration tube will be filled provided no other function is active. The device status **Fill CALIB. tube** is displayed in the "Diagnosis" view and the "Maintenance" view of the product.

9.9.13 Manually starting filling of the cleaning tube

 This setting is possible from user level **Advanced user**.

The cleaning tube must be filled after changing the bottle with the cleaning fluid.

Filling of the cleaning tube occurs automatically in the last step of the function **MZ30 Change bottle Position 2**. See chap. [9.9.22 Step-by-step replacement of operating agent bottles](#).



1. In order to access the "Maintenance" view, tap  in the "Parameter" view of the FIA function.
2. Switch off the automatic analyses, calibrations and cleaning cycles. See chap. [9.9.4](#).
3. Tap **Manual task** **None**  and select **Fill CLEANING tube**.
4. Confirm.

 The cleaning tube will be filled provided no other function is active. The device status **Fill CLEANING tube** is displayed in the "Diagnosis" view and the "Maintenance" view of the product.

9.9.14 Manually starting commissioning

 This function must be performed at the first commissioning of the product, after product maintenance or after a pause in measurement greater than 48 hours. See chap. [8 Commissioning](#).

 This setting is possible from user level **Advanced user**.

1. Connect the product and the reagent unit via the software. See chap. [9.7.6](#).
2. In order to access the "Maintenance" view, tap  in the "Parameter" view of the FIA function.
3. Switch off the automatic analyses, calibrations and cleaning cycles. See chap. [9.9.4](#).
4. Tap **Manual task** **None**  and select **Initialize system**.
5. Confirm.

 Commissioning starts provided no other function is active. The device status **Initialisation** is displayed in the "Diagnosis" view and the "Maintenance" view of the product.

9.9.15 Manually starting draining of the reagent tube

 This setting is possible from user level **Advanced user**.

The reagent tube must be drained before changing the reagent bottle. Draining of the reagent tube occurs automatically in the function **MZ30 Change bottle Position 1**.

During maintenance work (for example, before unscrewing the tube module from the product) draining of the reagent tube can be started manually.

1. Make sure that the end of the tube is not immersed in the reagent solution. Insert the end of the tube in the hose holder.

2. In order to access the "Maintenance" view, tap  in the "Parameter" view of the FIA function.

3. Switch off the automatic analyses, calibrations and cleaning cycles. See chap. [9.9.4](#).

4. Tap **Manual task None**  and select **Drain REAGENT tube**.

5. Confirm.

 The reagent tube will be drained provided no other function is active. The device status **Drain REAGENT tube** is displayed in the "Diagnosis" view and the "Maintenance" view of the product.

9.9.16 Manually starting draining of the calibration tube

 This setting is possible from user level **Advanced user**.

The calibration tube must be drained before changing the bottle with the calibration solution. Draining of the calibration tube occurs automatically in the function **MZ30 Change bottle Position 3**.

During maintenance work (for example, before unscrewing the tube module from the product) draining of the calibration tube can be started manually.

1. Make sure that the end of the tube is not immersed in the calibration solution. Insert the end of the tube in the hose holder.

2. In order to access the "Maintenance" view, tap  in the "Parameter" view of the FIA function.

3. Switch off the automatic analyses, calibrations and cleaning cycles. See chap. [9.9.4](#).

4. Tap **Manual task None**  and select **Drain CALIB. tube**.

5. Confirm.

 The calibration tube will be drained provided no other function is active. The device status **Drain CALIB. tube** is displayed in the "Diagnosis" view and the "Maintenance" view of the product.



9.9.17 Manually starting draining of the tube for cleaning solution

 This setting is possible from user level **Advanced user**.

The tube for cleaning solution must be drained before changing the bottle with the cleaning solution.

Draining of the tube for cleaning solution occurs automatically in the function **MZ30 Change bottle Position 2**.

You can manually start the draining of the tube for calibration solution:

1. Make sure that the end of the tube is not immersed in cleaning solution. Insert the end of the tube in the hose holder.
2. In order to access the "Maintenance" view, tap  in the "Parameter" view of the FIA function.
3. Switch off the automatic analyses, calibrations and cleaning cycles. See chap. [9.9.4](#).
4. Tap **Manual task** **None**  and select **Drain CLEANING tube**.
5. Confirm.

 The tube for the cleaning solution will be drained provided no other function is active. The device status **Drain CLEANING tube** is displayed in the "Diagnosis" view and the "Maintenance" view of the product.

9.9.18 Activate or stop simulation of an iron content

NOTICE







During the simulation, simulated values are given out and not the current measured values. Simulated values can influence devices downstream of the product.

- ▶ Make sure that the devices or processes downstream of the product are not damaged.



This setting is available from user level **Installer**.

Check the operation (for example: make sure that the warning limits and/or error limits are correctly set) of the product and/or processes through simulation of iron content.

1. In order to access the "Maintenance" view, tap  in the "Parameter" view of the FIA function.
2. Switch off the automatic analyses, calibrations and cleaning cycles. See chap. [9.9.4](#).
3. To simulate an iron content, tap **Simulation value** **0 mg/l**  and enter the iron content to be simulated.
4. Confirm.
5. To activate the simulation, tap **Simulation** **OFF**  and select **ON**.
6. Confirm.
7.  The entered measurement value will be given out, once no other function is active.
7. To stop the simulation, tap **Simulation** **ON**  and select **OFF**.
8. Confirm.
8.  Simulation is stopped.

9.9.19 Hold the last measured value

NOTICE



While the hold function is activated, the measured value is not updated.

► Make sure that the devices or processes downstream of the product are not negatively affected.



This setting is possible from user level **Advanced user**.

If necessary, the last measured value can be held. The last measured value is then transmitted until such time as this function is switched off.

1. In order to access the "Maintenance" view, tap  in the "Parameter" view of the FIA function.
2. Tap **Hold OFF**  and select **ON** in order to hold the last measured value.
3. Confirm.



 The last measured value is held.

9.9.20 Switching on the saving of the iron contents measured during calibration



This setting is possible from user level **Advanced user**.

The values measured during calibration can be saved. For differentiation, these values are output as negative values.



1. In order to access the "Maintenance" view, tap  in the "Parameter" view of the FIA function.
2. Tap **Log Fe-values during calibration OFF**  and select **ON**.
3. Confirm.

 The iron contents measured during calibration are logged and displayed.

9.9.21 Switching off the saving of the iron contents measured during calibration



This setting is possible from user level **Advanced user**.

1. In order to access the "Maintenance" view, tap  in the "Parameter" view of the FIA function.
2. Tap **Log Fe-values during calibration ON**  and select **OFF**.
3. Confirm.

 The iron contents measured during calibration are not saved.

9.9.22 Step-by-step replacement of operating agent bottles

 This setting is possible from user level **Advanced user**.

DANGER

Danger due to the nature of the operating agents.

- ▶ Observe the rules in force concerning accident prevention and safety and which relate to the use of hazardous products.
- ▶ Observe the information in the safety data sheet on the use of the operating agents.
- ▶ Dispose of waste containing chemicals produced by the system in an environmentally friendly manner.

If an operating agent is empty, a message automatically occurs. If a reagent unit with electronics is used, the product must be connected to the reagent unit type MZ30 via the software.



→ Using a small flat-blade screwdriver, turn the four bayonet locks on the front of the housing by no more than a quarter turn (the locks are thus not pressed too hard).

→ Fold down the cover.

→ To change the operating agents, start the following step-by-step procedure.

→ The process can be terminated at any step using .

1. In order to access the "Maintenance" view, select  in the "Parameter" view of the RGU.

2. Select **MZ30 Change bottle Position 1**  or **MZ30 Change bottle Position 2**  or **MZ30 Change bottle Position 3** .

 Exchanging the reagent unit bottles is only possible in device status **Idle**. An active function can be interrupted in the first step of the wizard.

3. Step 1/6: to interrupt a function in progress, select . The barcodes are scanned. If an error message is displayed, refer to chap. [10.6 Troubleshooting if a message is displayed](#).

4. Pull out the bottle holder.

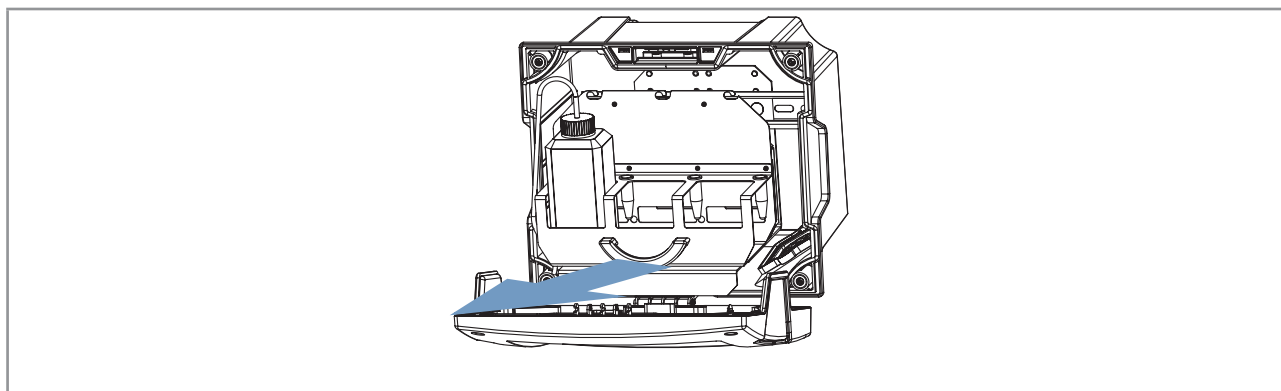

Figure 13: Pull out the bottle holder

5. Step 2/6: Remove the bottle from the holder. Remove the cap of the bottle and insert the tube in the hose holder provided.

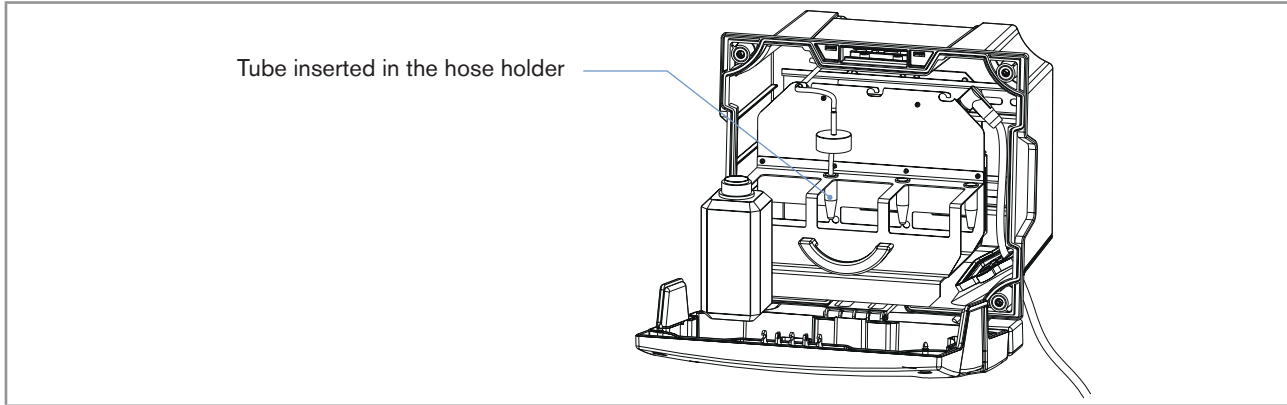









Figure 14: Insert tube in the hose holder

6. 
7. Step 3/6: Empty the residue in the bottle into the waste container. Dispose the empty bottle and residue in accordance with local regulations.
8. Open a new bottle and remove the cap. Remove the hose with cap from the hose holder and insert into the new bottle. Screw on the cap. Place the new bottle in the same position of the bottle holder.
9. 
10. Step 4/6: The barcode of the new bottle is read, to ensure that the new bottle conforms in terms of the type of operating agent and shelf life. If an error message is displayed take account of the displayed information.
11. If no error message is displayed, tap .
12. Step 5/6: The pump operates for 15 seconds. When the pump switches off, tap .
13. Step 6/6: In order to restart the interrupted function, tap .
14. Slide back the bottle holder.
-  The operating agent bottle has been changed.
15. Fold the housing cover upwards.
16. Using a small flat-blade screwdriver, turn the four bayonet locks on the front of the housing by no more than a quarter turn (the locks are thus not pressed too hard).
-  If a reagent unit with electronics is used, the barcode information and the fill levels are updated.
-  If a reagent unit without electronics is used, the fill levels are set to 250 ml.

10 MAINTENANCE AND TROUBLESHOOTING

10.1 Safety instructions



DANGER

Danger due to the nature of the operating agents.

- ▶ Observe the rules in force concerning accident prevention and safety and which relate to the use of hazardous products.
- ▶ Observe the information in the safety data sheet. The safety data sheets can be found at
 - Reagent: <http://sds-id.com/200123-8>
 - Cleaning solution: <http://sds-id.com/200124-7>
 - Calibration solution: <http://sds-id.com/200122-9>
- ▶ Dispose of waste containing chemicals produced by the system in an environmentally friendly manner.



WARNING

Risk of injury due to non-conforming maintenance

- ▶ Maintenance must only be carried out by qualified and skilled staff with the appropriate tools.

NOTICE

Risk of damage to the product due to the power supply.

- ▶ Shut down and isolate the electrical power source before carrying out any work on the system.

10.2 Performing maintenance work

The majority of maintenance work can be configured and performed through the software. See chap. [9.9 Setting maintenance work](#).

Before maintenance work, the last measured value can be held. See chap. [9.9.19 Hold the last measured value](#).

10.3 Cleaning the outside of the product

Clean the outside of the product with a cloth moistened with water (max. 40 °C).

10.4 Removal of the product from the backplane



DANGER

Danger due to the nature of the operating agents.

- ▶ Observe the rules in force concerning accident prevention and safety and which relate to the use of hazardous products.
- ▶ Observe the information in the safety data sheet. The safety data sheets can be found at
 - Reagent: <http://sds-id.com/200123-8>
 - Cleaning solution: <http://sds-id.com/200124-7>
 - Calibration solution: <http://sds-id.com/200122-9>
- ▶ Dispose of waste containing chemicals produced by the system in an environmentally friendly manner.



DANGER

When unscrewing the fluid interface to the tube module, the operating agents may completely flow out due to the under pressure of the water column.





- Before unscrewing the fluid interface to the tube module, drain all tubes using the product software. See chap. 9.9.15, chap. 9.9.16 and chap. 9.9.17.
- Because the waste tube drains when unscrewing the fluid interface from the tube module, leave the waste tube in the waste container.
- Pull the lever of the product into the unlocked position.
- At all times, avoid kinking or damaging the tubes.
- Remove the product from the backplane and place it with the fluid interface facing upwards.
- Check that the tubes are drained.
- Loosen the screws of the fluid interface and pull off the interface. Ensure that all the seals remain in the removed interface.
- Remove any drops on the device or the interface with a clean cloth. Ensure that all the seals remain in the removed interface.
- Protect the removed interface so that no contamination is possible.

10.5 Troubleshooting, when no message is displayed

Colour of the product status LED	OFF
Possible cause	The product or system is not energized
What to do?	<ol style="list-style-type: none"> 1. Check the wiring. 2. Make sure that the voltage supply on the distribution terminal strip of measuring system type 8905 is 24 V DC. 3. Check that the power supply source is working properly.

10.6 Troubleshooting if a message is displayed

If an error or a warning message has been generated:

- the status light of the system is red or orange,
- the status LED of the product is red or orange,
- the symbol  or  or  or  is displayed on the icon of the product, in the list of connected devices,
- the symbol  appears in the top left corner of the display,

→ tap  to access the "Messages List".

10.6.1 Message "Low limit in reagent-solution tank detected"

Displayed message	Low limit in reagent-solution tank detected
Symbol displayed on the icon of the product in the list of devices	
Possible cause	Remaining fill level of reagent less than 10%. The product stops the analysis.
What to do?	→ Insert a new reagent bottle. See chap. 9.9.22 Step-by-step replacement of operating agent bottles.

Displayed message	Low limit in reagent-solution tank detected
Symbol displayed on the icon of the product in the list of devices	
Product LED	Blue
Possible cause	Remaining fill level of reagent between 10% and 20%.
What to do?	→ Prepare new reagent bottle.

10.6.2 Message "Low limit in cleaning-solution tank detected"

Displayed message	Low limit in cleaning-solution tank detected
Symbol displayed on the icon of the product in the list of devices	
Possible cause	Remaining fill level of cleaning solution less than 10%. The product stops the analysis.
What to do?	→ Insert a new cleaning solution bottle. See chap. 9.9.22 Step-by-step replacement of operating agent bottles.

Displayed message	Low limit in cleaning-solution tank detected
Symbol displayed on the icon of the product in the list of devices	
Product LED	Blue
Possible cause	Remaining fill level of cleaning solution between 10% and 20%.
What to do?	→ Prepare a new cleaning solution bottle.

10.6.3 Message "Low limit in calibration-solution tank detected"

Displayed message	Low limit in calibration-solution tank detected
Symbol displayed on the icon of the product in the list of devices	
Possible cause	Remaining fill level of calibration solution less than 10%. The product stops the analysis.
What to do?	→ Insert a new calibration solution bottle. See chap. 9.9.22 Step-by-step replacement of operating agent bottles .

Displayed message	Low limit in calibration-solution tank detected
Symbol displayed on the icon of the product in the list of devices	
Product LED	Blue
Possible cause	Remaining fill level of cleaning solution between 10% and 20%.
What to do?	→ Prepare a new calibration solution bottle.

10.6.4 Message "Measured Fe value too large"

Displayed message	Measured Fe value too large
Symbol displayed on the icon of the product in the list of devices	
Possible cause	The iron content of the water sample is greater than the permitted maximum value. The message is displayed, if in Messages triggers Errors ▶ ("Parameter" view of the function FIA) the following settings have been made: <ul style="list-style-type: none"> ▪ The error "activation flag" for the upper threshold value of the iron content is selected, ▪ And the upper threshold limit set for the Iron content is attained. → The product continues to measure. However, the values are not displayed or exported, for as long as the error is active. The last permissible value continues to be output.
What to do?	As soon as the iron content returns to within the permitted range, the error is automatically reset.

Displayed message	Measured Fe value too large
Symbol displayed on the icon of the product, in the list of devices	
Possible cause	<p>The iron content of the water sample is greater than the permitted maximum value.</p> <p>The message is displayed, if in Messages triggers Warnings ▶ ("Parameter" view of the function FIA) the following settings have been made:</p> <ul style="list-style-type: none"> ▪ The warning "activation flag" for the upper threshold value of the iron content is selected, ▪ And the upper threshold limit set for the Iron content is attained. <p>→ The product continues to measure. The values continue to be displayed and exported.</p>
What to do?	As soon as the iron content returns to within the permitted range, the warning is automatically reset.

10.6.5 Message "Measured Fe value too low"

Displayed message	Measured Fe value too low
Symbol displayed on the icon of the product in the list of devices	
Possible cause	<p>The iron content of the water sample is less than the permitted minimum value.</p> <p>The message is displayed, if in Messages triggers Errors ▶ ("Parameter" view of the function FIA) the following settings have been made:</p> <ul style="list-style-type: none"> ▪ The error "activation flag" for the lower threshold value of the iron content is selected, ▪ And the lower threshold limit set for the Iron content is attained. <p>→ The product continues to measure. However, the values are not displayed or exported, for as long as the error is active.</p>
What to do?	As soon as the iron content returns to within the permitted range, the error is automatically reset.

Displayed message	Measured Fe value too low
Symbol displayed on the icon of the product in the list of devices	
Possible cause	<p>The iron content of the water sample is less than the permitted minimum value.</p> <p>The message is displayed, if in Messages triggers Warnings ("Parameter" view of the function FIA) the following settings have been made:</p> <ul style="list-style-type: none"> ▪ The warning "activation flag" for the lower threshold value of the iron content is selected, ▪ And the lower threshold limit set for the Iron content is attained. <p>→ The product continues to measure. The values continue to be displayed and exported.</p>
What to do?	As soon as the iron content returns to within the permitted range, the warning is automatically reset.

10.6.6 Message "Waste container fill level limit reached"

Displayed message	Waste container fill level limit reached
Symbol displayed on the icon of the product in the list of devices	
Possible cause	<p>95% of the entered volume of the waste container has been reached.</p> <p>The message is displayed, if container fill level monitoring is activated.</p> <p>The product stops the analysis.</p>
What to do?	<p>→ Empty or change the waste container.</p> <p>→ Set the fill level of the waste container to zero See chap. 9.7.10 Setting the fill level of the waste container to zero.</p> <p>→ When exchanging the container for a container with a different volume, enter the new capacity in Size of waste tank. See chap. 9.7.8 Monitoring the fill level of the waste container.</p>

Displayed message	Waste container fill level limit reached
Symbol displayed on the icon of the product in the list of devices	
Product LED	Blue
Possible cause	<p>80% of the entered volume of the waste container has been reached.</p> <p>The message is displayed, if container fill level monitoring is activated.</p>
What to do?	<p>→ Empty or change the waste container.</p> <p>→ Set the fill level of the waste container to zero See chap. 9.7.10 Setting the fill level of the waste container to zero.</p> <p>→ When replacing the container with a container of a different volume, enter the new capacity in Size of waste tank. See chap. 9.7.8 Monitoring the fill level of the waste container.</p>

10.6.7 Message "Measured Fe value exceeds valid range"

Displayed message	Measured Fe value exceeds valid range.
Symbol displayed on the icon of the product in the list of devices	
Possible cause	The iron content is outside the measurement range 0...10 mg/l. <ul style="list-style-type: none"> ▪ The values are invalid. ▪ NAN is displayed in the field Last measurement Fe.
What to do?	As soon as the iron content returns to within the measurement range, the error is automatically reset.

10.6.8 Message "Inlet temperature low limit"

Displayed message	Inlet temperature low limit
Symbol displayed on the icon of the product in the list of devices	
Possible cause	The temperature of the water sample is less than 10 °C. The product stops the analysis.
What to do?	→ Raise the temperature of the water sample. As soon as the liquid temperature returns to within the permitted range, the error is automatically reset.

10.6.9 Message "Inlet temperature upper limit"

Displayed message	Inlet temperature upper limit
Symbol displayed on the icon of the product in the list of devices	
Possible cause	The temperature of the water sample is greater than 40 °C. The product stops the analysis.
What to do?	→ Reduce the temperature of the water sample. As soon as the liquid temperature returns to within the permitted range, the error is automatically reset.

10.6.10 Message "The test of valves and pumps failed"

Displayed message	The test of valves and pumps failed.
Symbol displayed on the icon of the product in the list of devices	
Possible cause	Damage to the software and/or hardware. The test is performed before and during the analyses by the product.
What to do?	→ Have the product checked by Bürkert Service and Support.

10.6.11 Message "Power supply voltage limit has been reached"

Displayed message	Power supply voltage limit has been reached
Symbol displayed on the icon of the product in the list of devices	
Possible cause	The power supply is outside the permitted operating voltage.
What to do?	→ Restart the product → If the error occurs again, have the product checked by Bürkert Service and Support.

10.6.12 Message "Container 1 in MZ30 is placed at the wrong position"

Displayed message	Container 1 in MZ30 is placed at the wrong position
Symbol displayed on the icon of the product in the list of devices	
Possible cause	Can only be displayed if a reagent unit with electronics is used. The reagent bottle has not been placed in position 1 of the reagent unit.
What to do?	→ Provide the reagent bottle. → Using the software function MZ30 Change bottle Position 1 , change the inserted bottle with a reagent bottle.

10.6.13 Message "Container 2 in MZ30 is placed at the wrong position"

Displayed message	Container 2 in MZ30 is placed at the wrong position
Symbol displayed on the icon of the product in the list of devices	
Possible cause	Can only be displayed if a reagent unit with electronics is used. The cleaning solution bottle is not in the middle position of the reagent unit.
What to do?	→ Provide the bottle with the cleaning solution. → Using the software function MZ30 Change bottle Position 2 , change the inserted bottle with a cleaning solution bottle.

10.6.14 Message "Container 3 in MZ30 is placed at the wrong position"

Displayed message	Container 3 in MZ30 is placed at the wrong position
Symbol displayed on the icon of the product in the list of devices	
Possible cause	Can only be displayed if a reagent unit with electronics is used. The calibration solution bottle is not in the right-hand position of the reagent unit.
What to do?	→ Provide the bottle with the calibration solution. → Using the software function MZ30 Change bottle Position 3 , change the inserted bottle with a calibration solution bottle.

10.6.15 Message "Reagent solution expiration date"

Displayed message	Reagent solution expiration date
Symbol displayed on the icon of the product in the list of devices	
Possible cause	Can only be displayed if a reagent unit with electronics is used. The expiration date of the reagent has been passed. The expiration date is read from the barcode on the bottle label. The product stops the analysis.
What to do?	→ Use a reagent bottle with a valid expiration date.

Displayed message	Reagent solution expiration date
Symbol displayed on the icon of the product in the list of devices	
Product LED	Blue
Possible cause	Can only be displayed if a reagent unit with electronics is used. The set period before the expiration date has expired. See chap. 9.7.11 Monitoring the expiration date of the operating agents (only MZ30 with electronics) . The message is displayed, if reagent expiration date monitoring is activated.
What to do?	→ Prepare a reagent bottle with a valid expiration date.

10.6.16 Message "Clean solution expiration date"

Displayed message	Clean solution expiration date
Symbol displayed on the icon of the product in the list of devices	
Possible cause	<p>Can only be displayed if a reagent unit with electronics is used.</p> <p>The expiration date of the cleaning solution has been passed.</p> <p>The expiration date is read from the barcode on the bottle label.</p> <p>The product stops the analysis.</p>
What to do?	→ Use a bottle with a cleaning solution having a valid expiration date.

Displayed message	Clean solution expiration date
Symbol displayed on the icon of the product in the list of devices	
Product LED	Blue
Possible cause	<p>Can only be displayed if a reagent unit with electronics is used.</p> <p>The set period before the expiration date has expired. See chap. 9.7.11 Monitoring the expiration date of the operating agents (only MZ30 with electronics).</p> <p>The message is displayed if reagent expiration date monitoring is activated.</p>
What to do?	→ Prepare a bottle with a cleaning solution having a valid expiration date.

10.6.17 Message "Calibration solution expiration date"

Displayed message	Calibration solution expiration date
Symbol displayed on the icon of the product in the list of devices	
Possible cause	<p>Can only be displayed if a reagent unit with electronics is used.</p> <p>The expiration date of the calibration solution has been passed.</p> <p>The expiration date is read from the barcode on the bottle label.</p> <p>The product stops the analysis.</p>
What to do?	→ Use a bottle with a calibration solution having a valid expiration date.

Displayed message	Calibration solution expiration date
Symbol displayed on the icon of the product in the list of devices	
Product LED	Blue
Possible cause	<p>Can only be displayed if a reagent unit with electronics is used.</p> <p>The set period before the expiration date has expired. See chap. 9.7.11 Monitoring the expiration date of the operating agents (only MZ30 with electronics).</p> <p>The message is displayed if reagent expiration date monitoring is activated.</p>
What to do?	→ Prepare a bottle with a calibration solution having a valid expiration date.

10.6.18 Message "Communication with MZ30 failed"

Displayed message	Communication with MZ30 failed
Symbol displayed on the icon of the product in the list of devices	
Possible cause	Can only be displayed if a reagent unit with electronics is used. The connection between the product and the reagent unit has been interrupted.
What to do?	<p>→ Check whether the connection cable is properly connected.</p> <p>→ Check whether the bus connection is correct, for example does the MZ30 appear in the display.</p> <p>→ Check whether the correct serial number of the reagent unit has been set in the product "Parameter" view. See chap. 9.7.6 Connecting the product with the reagent unit to monitor the operating agents (only MZ30 with electronics).</p>

10.6.19 Message "Initializing communication with MZ30"

Displayed message	Initializing communication with MZ30
Symbol displayed on the icon of the product in the list of devices	
Possible cause	Can only be displayed if a reagent unit with electronics is used. This message is generated if the reagent unit is set as available in the product "Parameter" view, but the product has not yet found the reagent unit. See chap. 9.7.6 Connecting the product with the reagent unit to monitor the operating agents (only MZ30 with electronics) .
What to do?	<p>→ The message disappears as soon as communication is established between the product and the reagent unit.</p> <p>→ If the communication fails, a new message will be generated. See chap. 10.6.18.</p>

10.6.20 Message "Automatic calibration failed"

Displayed message	Automatic calibration failed
Symbol displayed on the icon of the product in the list of devices	
Possible cause	The values determined by the calibration lie outside the permitted range. The system has performed three calibration cycles. The last valid calibration value is used for the analyses.
What to do?	<p>→ Change the reagent.</p> <p>→ Change the calibration solution.</p> <p>→ Perform a manual commissioning. See chap. 9.9.14.</p>

11 SPARE PARTS AND ACCESSORIES



NOTICE

Risk of injury and/or damage caused by the use of unsuitable parts.

Incorrect accessories and unsuitable replacement parts can cause injuries and damage the product and the surrounding area.

- Use only original accessories and original replacement parts from Bürkert.



Damage to the reference solutions during transport and/or storage.

- Observe the storage and transport temperatures given on the bottle labels.

Accessories	Order code
büS stick set	772426
büS cable	772626
M12 plug, angled	772419
Spare part	Order code
Fe reagent solution, 250 ml	807613
Fe cleaning solution, 250 ml	807614
Fe calibration solution, 250 ml	807615

12 PACKAGING, TRANSPORT

NOTICE

Damage due to transport

Transport may damage an insufficiently protected product.

- Transport the product in shock-resistant packaging and away from humidity and dirt.
- Do not expose the product to temperatures that may exceed the admissible storage temperature range.
- Protect the electrical interfaces using protective plugs.

13 STORAGE

DANGER

Danger due to the nature of the operating agents.

- ▶ Observe the rules in force concerning accident prevention and safety and which relate to the use of hazardous products.
- ▶ Observe the information in the safety data sheet. The safety data sheets can be found at
 - Reagent: <http://sds-id.com/200123-8>
 - Cleaning solution: <http://sds-id.com/200124-7>
 - Calibration solution: <http://sds-id.com/200122-9>
- ▶ Dispose of waste containing chemicals produced by the system in an environmentally friendly manner.

NOTICE

Poor storage can damage the product.

13.1 Storage of the product

1. Remove the product from the backplane before storage. See chap. [10.4 Removal of the product from the backplane](#).
2. Store the product at an ambient temperature of $-10...+60$ °C.
3. Store the product in a dry place away from dust.

13.2 Commissioning the product after a period of storage

Before commissioning the product after a period of storage:

1. Mount the product on the backplane. See chap. [7 Installation](#).
2. If the supply voltage of the system is switched off, allow the water sample to flow through the product for at least 30 minutes.
3. Manually start commissioning See chap. [9.9.14](#).

14 DISPOSAL OF THE PRODUCT

→ Dispose of the product and its packaging in an environmentally-friendly way.

NOTICE

Damage to the environment caused by products contaminated by fluids.

- ▶ Keep to the existing provisions on the subject of waste disposal and environmental protection.
- ▶ Dispose of waste containing chemicals produced by the system in an environmentally friendly manner.

