

Type MS01

pH sensor cube



Operating Instructions

We reserve the right to make technical changes without notice.
Technische Änderungen vorbehalten.
Sous réserve de modifications techniques.

© Bürkert SAS, 2014 - 2020

Operating Instructions 2011/01_EU-ML 00566496 Original EN





| | | |
|-----|---|----|
| 1 | ABOUT THE DOCUMENT | 9 |
| 1.1 | Symbols used | 9 |
| 1.2 | Definition of the term product | 9 |
| 1.3 | Definition of the term system | 9 |
| 1.4 | Definition of the term büS | 10 |
| 2 | INTENDED USE | 10 |
| 3 | BASIC SAFETY INFORMATION | 11 |
| 4 | GENERAL INFORMATION | 12 |
| 4.1 | Manufacturer's address and international contacts | 12 |
| 4.2 | Warranty conditions | 12 |
| 4.3 | Information on the internet | 12 |
| 5 | DESCRIPTION | 13 |
| 5.1 | Product | 13 |
| 5.2 | Type label | 14 |
| 5.3 | Memory card | 14 |
| 5.4 | Product-status indicator | 15 |
| 6 | TECHNICAL DATA | 16 |
| 6.1 | Conditions of use | 16 |
| 6.2 | Conformity to standards and directives | 16 |
| 6.3 | Materials the product is made of | 16 |
| 6.4 | Fluid data | 16 |
| 6.5 | Measurement data | 17 |
| 6.6 | Electrical data | 17 |
| 6.7 | Communication | 17 |
| 7 | INSTALLATION | 18 |
| 7.1 | Safety instructions | 18 |
| 7.2 | Mounting the product on the backplane | 18 |

| | | |
|--------|---|----|
| 8 | COMMISSIONING | 19 |
| 8.1 | Safety instructions | 19 |
| 8.2 | First commissioning of the system | 19 |
| 9 | ADJUSTMENT | 20 |
| 9.1 | Safety instructions | 20 |
| 9.2 | Adjustment tools and adjustment software | 20 |
| 9.3 | Description of the user interface | 20 |
| 9.4 | Available login user levels | 21 |
| 9.5 | Product functions and menus | 22 |
| 10 | PH SENSOR - PARAMETER | 23 |
| 10.1 | Deactivate or activate the measurement of the impedance value of the reference electrode . 23 | |
| 10.2 | Damp or not the variations of the measured pH-values | 24 |
| 10.3 | Monitor the impedance value of the reference electrode | 24 |
| 10.4 | Monitor the pH value of the water sample | 25 |
| 10.5 | Monitor the temperature value of the water sample | 26 |
| 10.6 | Monitor the leakage-current value of the measuring cell | 27 |
| 10.7 | Freeze the values that are transmitted on the fieldbus | 28 |
| 10.7.1 | Manual freeze | 28 |
| 10.7.2 | Automatic freeze | 29 |
| 10.7.3 | Change the binary event for the automatic freeze | 31 |
| 10.8 | Stop the manual freeze or the automatic freeze | 31 |
| 10.9 | Restore some parameters to their factory values | 32 |
| 10.10 | Deactivate the monitoring of all the parameters, set the threshold values to their factory values | 32 |
| 11 | PH SENSOR - DIAGNOSTICS | 33 |
| 12 | PH SENSOR - MAINTENANCE | 34 |
| 12.1 | Calibration of the pH sensor | 34 |
| 12.1.1 | Manually calibrate the pH sensor | 34 |
| 12.1.2 | 1-point calibration procedure of the pH sensor | 35 |

MAN 1000239756 EN Version: E Status: RL (released | freigegeben) printed: 16.01.2025

| | | | |
|----|--------|---|----|
| | 12.1.3 | 2-point calibration procedure of the pH sensor | 40 |
| | 12.1.4 | Connect the Type MZ15 calibration-and-cleaning tool to the Type 8905 system that has no Type ME21 touchscreen | 45 |
| | 12.2 | Manually calibrate the temperature sensor | 46 |
| | 12.3 | Plan the calibrations | 47 |
| | 12.4 | Check the correct behaviour of the system and the product | 48 |
| | 12.5 | Stop the simulation mode | 48 |
| | 12.6 | Restore the offset value of the temperature to its factory value | 49 |
| | 12.7 | Restore the offset value and the slope value of the pH-sensor calibration-curve to their factory values | 49 |
| 13 | | GENERAL SETTINGS - PARAMETER | 50 |
| | 13.1 | Enter a name for the product | 50 |
| | 13.2 | Enter the location of the product | 51 |
| | 13.3 | Enter a description for the product | 51 |
| | 13.4 | Enter a unique name for the product | 52 |
| | 13.5 | Change the transmission speed of the product | 52 |
| | 13.6 | Address of a product connected to büS | 53 |
| | 13.7 | Change the address of the product connected to a CANopen fieldbus | 53 |
| | 13.8 | Set the digital communication for büS or for a CANopen fieldbus | 53 |
| | 13.9 | Stop sending the measured process data (PDOs) to büS or to the CANopen fieldbus | 54 |
| | 13.10 | Change the time to check the presence of a participant on the fieldbus | 54 |
| | 13.11 | Disable or enable the diagnostics | 55 |
| | 13.12 | Set the transmission time between 2 values of a PDO | 56 |
| | 13.13 | Restore all PDOs to their default values | 57 |
| 14 | | GENERAL SETTINGS - DIAGNOSTICS | 58 |
| | 14.1 | Read the number of product starts | 58 |
| | 14.2 | Check the presence of the memory card | 58 |
| | 14.3 | Read the current time | 59 |
| | 14.4 | Read the number of current receive errors | 59 |
| | 14.5 | Read the maximum number of receive errors since the last power-up of the device | 59 |

| | | |
|--------|--|----|
| 14.6 | Read the number of current transmit errors | 59 |
| 14.7 | Read the maximum number of transmit errors since the last power-up of the device | 59 |
| 14.8 | Reset the 2 maximum error counters | 59 |
| 14.9 | Read whether the measured process data is sent on bÜS or on the CANopen fieldbus | 60 |
| 14.10 | Read the generated events | 60 |
| 15 | GENERAL SETTINGS - MAINTENANCE | 62 |
| 15.1 | Restart the product | 62 |
| 15.2 | Reset the product to its factory settings | 62 |
| 16 | PROCESS DATA OBJECTS | 63 |
| 16.1 | Transmitted PDOs | 63 |
| 16.2 | Received PDOs | 63 |
| 16.3 | Structure of the PDO4 pH State | 63 |
| 17 | MAINTENANCE | 65 |
| 17.1 | Safety instructions | 65 |
| 17.2 | When performing a maintenance operation | 65 |
| 17.3 | Remove the product from the backplane of the system | 65 |
| 17.4 | Clean the product | 66 |
| 17.5 | Replace the reference electrode of the product | 69 |
| 17.6 | Replace the measuring cell of the product | 70 |
| 17.7 | Replace a defect product by a new one | 70 |
| 17.8 | Transfer the product settings to another product | 70 |
| 18 | TROUBLESHOOTING | 71 |
| 18.1 | Product-status indicator is off | 71 |
| 18.2 | Measured pH values seem to be wrong or fluctuate | 71 |
| 18.2.1 | Measured pH values seem to be wrong | 71 |
| 18.2.2 | Measured pH values fluctuate | 73 |
| 18.3 | Measured temperature values seem to be wrong | 73 |

| | | |
|---------|---|----|
| 19 | TROUBLESHOOTING WITH MESSAGES | 74 |
| 19.1 | Messages  : failure, error or malfunction | 74 |
| 19.1.1 | Message Error 2 memory | 74 |
| 19.1.2 | Message DPB open IC109 | 74 |
| 19.1.3 | Message büS event: producer not found | 75 |
| 19.1.4 | Message büS is not operational | 75 |
| 19.2 | Messages  : function check | 75 |
| 19.2.1 | Message Simulation mode active | 75 |
| 19.2.2 | Message Hold mode active | 75 |
| 19.3 | Messages  : out of specification | 76 |
| 19.3.1 | Message Error: too low pH | 76 |
| 19.3.2 | Message Error: too high pH | 76 |
| 19.3.3 | Message Error: too low temperature | 76 |
| 19.3.4 | Message Error: too high temperature | 76 |
| 19.3.5 | Message Error: too low reference impedance | 77 |
| 19.3.6 | Message Error: too high reference impedance | 77 |
| 19.3.7 | Message Error: too low leakage current | 77 |
| 19.3.8 | Message Error: too high leakage current | 78 |
| 19.3.9 | Message Warning: too low pH | 78 |
| 19.3.10 | Message Warning: too high pH | 78 |
| 19.3.11 | Message Warning: too low temperature | 78 |
| 19.3.12 | Message Warning: too high temperature | 79 |
| 19.3.13 | Message Warning: too low reference impedance | 79 |
| 19.3.14 | Message Warning: too high reference impedance | 79 |
| 19.3.15 | Message Warning: too low leakage current | 80 |
| 19.3.16 | Message Warning: too high leakage current | 80 |
| 19.4 | Messages  : maintenance required | 81 |
| 19.4.1 | Message Pair cell with sensor in maintenance menu | 81 |
| 19.4.2 | Message Calibration date has expired | 81 |
| 19.5 | Messages  : informations | 81 |
| 19.5.1 | Message Transferable memory is not accessible | 81 |

| | | |
|----|--|----|
| 20 | SPARE PARTS AND ACCESSORIES | 82 |
| 21 | PACKAGING, TRANSPORT | 83 |
| 22 | STORAGE | 84 |
| | 22.1 To store the product for a maximum of 10 days | 84 |
| | 22.2 To store the product for more than 10 days | 84 |
| | 22.3 After storage | 84 |
| 23 | DISPOSAL OF THE PRODUCT | 85 |

1 ABOUT THE DOCUMENT

The document describes the entire life cycle of the product. Please keep the document in a safe place, accessible to all users and any new owners.

The document contains important safety information.

Failure to comply with the Operating Instructions can lead to hazardous situations.

- ▶ The document must be read and understood.

1.1 Symbols used



DANGER

Warns against an imminent danger.

- ▶ Failure to observe this warning can result in death or in serious injury.



WARNING

Warns against a potentially dangerous situation.

- ▶ Failure to observe this warning can result in serious injury or even death.



CAUTION

Warns against a possible risk.

- ▶ Failure to observe this warning can result in substantial or minor injuries.

NOTICE

Warns against material damage.



Advice or important recommendations.



Refers to information contained in the Operating Instructions or in other documents.

- ▶ Indicates an instruction to be carried out to avoid a danger, a warning or a possible risk.

→ Indicates a work step to be carried out.

- ✓ Indicates the result of a specific instruction.

Menu Identifies a text of a user interface.

1.2 Definition of the term product

The term "product" used within these Operating Instructions always refers to the Type MS01 pH sensor cube.

1.3 Definition of the term system

The term "system" used within these Operating Instructions always refers to the Type 8905 Online Analysis System.

1.4 Definition of the term büS

The term "büS" used in the Operating Instructions refers to the industrial communication, developed by Bürkert, based on the CANopen protocol. The term "büS" refers to the Bürkert system bus.

- For more information on büS, read the cabling guide available in English and German (Cabling_guide_for_büS_networks.pdf) at country.burkert.com search for "Guide for planning büS networks".
- For more information on CANopen which is related to the device, refer to the Operating Instructions "CANopen Network configuration" at country.burkert.com.

2 INTENDED USE

Use of this product that does not comply with the instructions could present risks to people, nearby installations and the environment.

- ▶ The product is intended solely for the measurement of the pH in water within a Type 8905 system.
- ▶ This product must be protected against electromagnetic interference, ultraviolet rays and, when installed outdoors, the effects of climatic conditions.
- ▶ This product must be used in compliance with the characteristics and commissioning and use conditions specified in the contractual documents and in the Operating Instructions.
- ▶ Requirements for the safe and proper operation of the product are proper transport, storage and installation, as well as careful operation and maintenance.
- ▶ Only use the product as intended.
- ▶ Observe any existing restraints when the product is exported.

3 BASIC SAFETY INFORMATION

This safety information does not take into account any contingencies or occurrences that may arise during installation, use and maintenance of the product.

The operating company is responsible for the respect of the local safety regulations including staff safety.



Various dangerous situations.

To avoid injury take care:

- ▶ to prevent any unintentional power supply switch-on.
- ▶ to carry out the installation and maintenance work by qualified and skilled staff with the appropriate tools.
- ▶ to use the product only if in perfect working order and in compliance with the instructions provided in these Operating Instructions.
- ▶ to observe the general technical rules during the planning and use of the product.
- ▶ not to use this product in explosive atmospheres.
- ▶ not to use this product in an environment incompatible with the materials from which it is made.
- ▶ not to make any external or internal modifications to the product.

NOTICE

Elements / Components sensitive to electrostatic discharges

- This product contains electronic components sensitive to electrostatic discharges. They may be damaged if they are touched by an electrostatically charged person or object. In the worst case scenario, these components are instantly destroyed or go out of order as soon as they are activated.
- To minimise or even avoid all damage due to an electrostatic discharge, take all the precautions described in the EN 61340-5-1 norm.
- Also ensure that you do not touch any of the live electrical components.

4 GENERAL INFORMATION

4.1 Manufacturer's address and international contacts

To contact the manufacturer of the product use following address:

Bürkert SAS

Rue du Giessen

BP 21

F-67220 TRIEMBACH-AU-VAL

You may also contact your local Bürkert sales office.

The addresses of our international sales offices are available on the Internet at: country.burkert.com

4.2 Warranty conditions

The condition governing the legal warranty is the conforming use of the product in observance of the operating conditions specified in the Operating Instructions.

4.3 Information on the internet

You can find the Operating Instructions and technical data sheets for Type MS01 at: country.burkert.com

5 DESCRIPTION

5.1 Product

The Type MS01 pH sensor cube is used in the Type 8905 system.

The electrical and fluid connections are made via the backplane of the Type 8905 system.

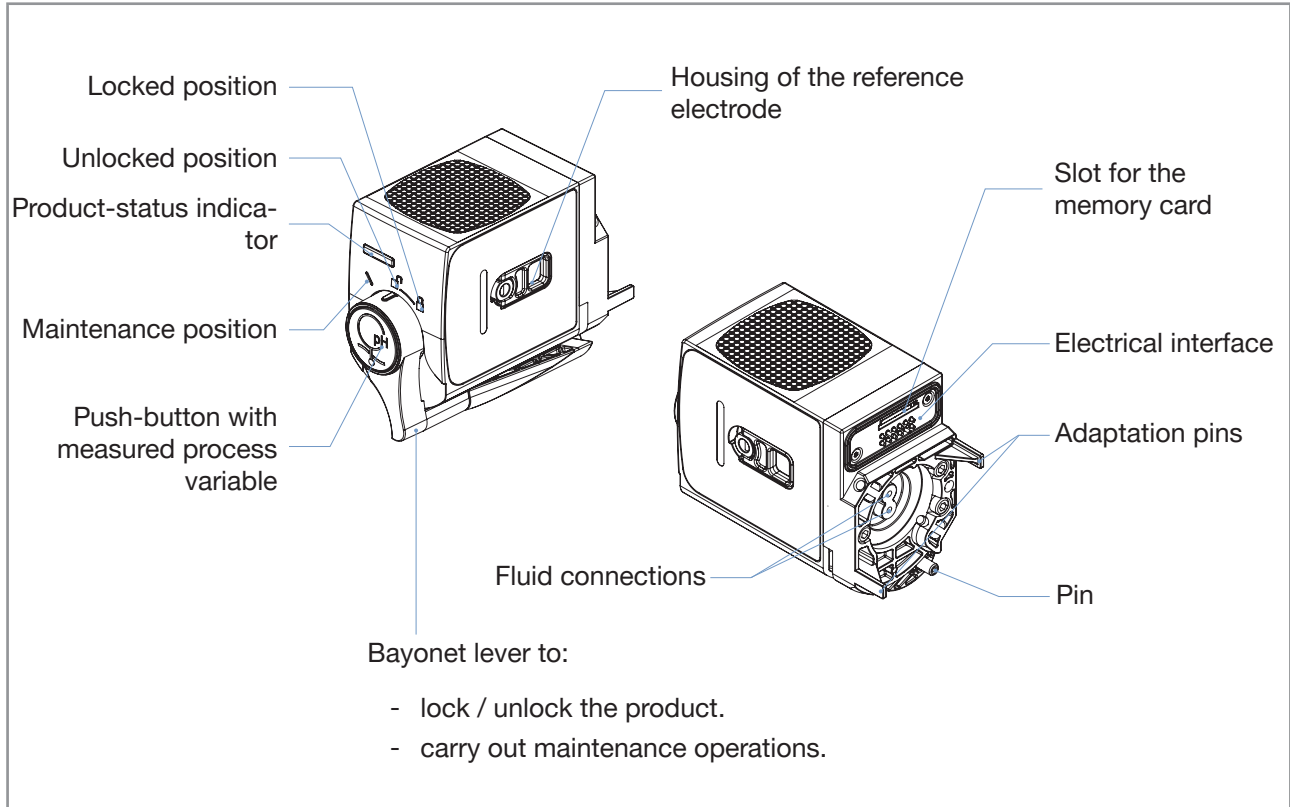

Fig. 1: Description of the product

5.2 Type label

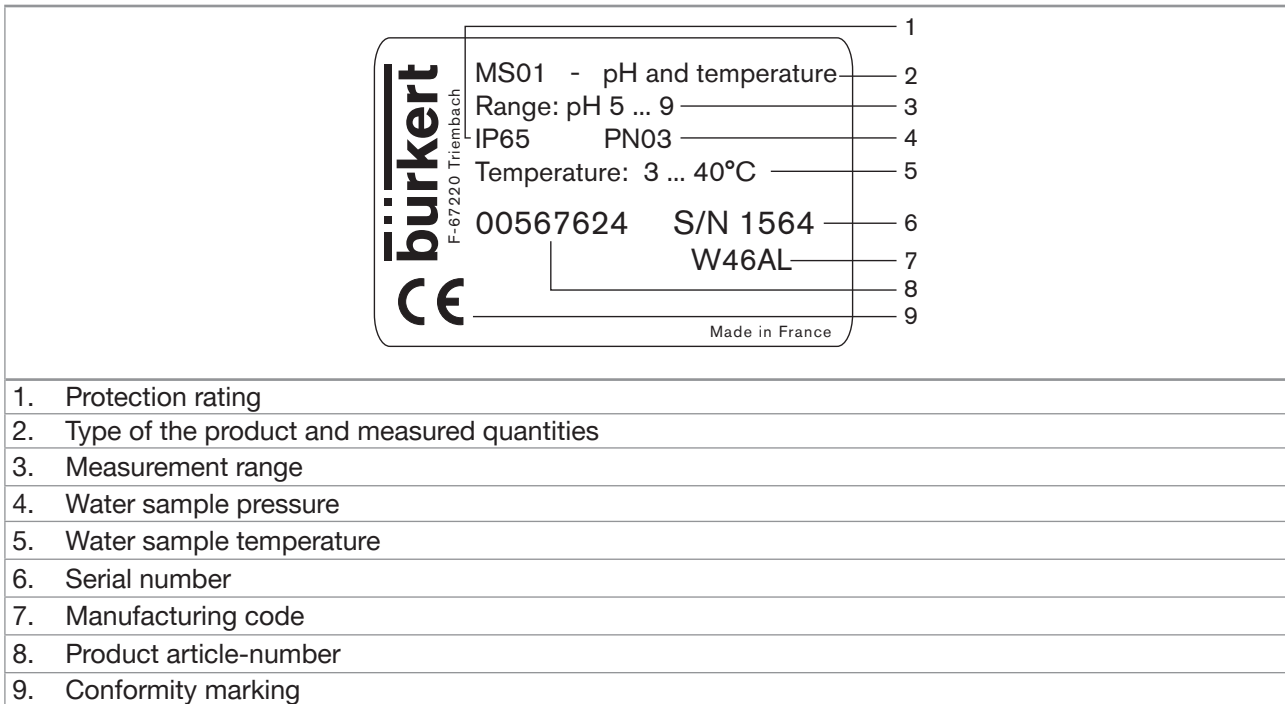

Fig. 2: Example of Type label

5.3 Memory card

NOTICE

- ▶ If the memory card is defective or lost, then buy a new memory card from your Bürkert sales office.

The product is delivered with a memory card that is inserted in the product.

At product start-up, there are two possibilities:

- If product-specific data is stored on the inserted memory card, the product adopts the data. At product delivery, the memory card contains product-specific data.
- If the inserted memory card is empty, the product loads its own data on the memory card. A new memory card is empty.

The data on the memory card can be transferred to another product Type MS01. For example, the data can be transferred from a defective product to a new product. The memory card transfers the following data:

- the user parameters, except the calibration parameters, which are specific to each product.
- the unique device name of the product. The unique device name permits to link the product to others devices that are connected to the fieldbus. Refer to chpt. [13.4](#).

5.4 Product-status indicator

The product-status indicator changes its colour and state based on the NAMUR NE 107 recommendation. Refer to [Table 1](#). The colour of the product-status indicator shows whether the product-internal diagnostics are active or inactive. If the product-internal diagnostics are active and different product states have been generated, the colour of the product-status indicator shows the product state with the highest priority.

If the product-status indicator flashes, then the product is selected in a man-machine interface such as the Bürkert Communicator software.

Table 1: Product-status indicator - Colours and states in accordance with NAMUR NE 107, edition 2006-06-12

| Status of the diagnostics on the product | Colour of the product-status indicator | Colour code (for a PLC) | Product status | Meaning |
|---|--|-------------------------|-----------------------------|--|
| Inactive or disabled diagnostics <ul style="list-style-type: none"> Product status changes are not shown. Messages are neither listed nor transmitted via any connected fieldbus. | White | 0 | - | Diagnostics are inactive. |
| Active or enabled diagnostics <ul style="list-style-type: none"> Product status is shown by the color of the device status indicator. Messages are listed and possibly transmitted via any connected fieldbus. | Green | 1 | - | Diagnostics are active and no event has been generated. |
| | Blue | 2 | Maintenance required | The device continues to measure but a function is temporarily restricted. → Do the required maintenance operation. |
| | Yellow | 3 | Out of specification | The ambient conditions or process conditions for the device are outside the permitted ranges. Device internal diagnostics point to problems in the device or with the process properties. |
| | Orange | 4 | Function check | Ongoing work on the device (for example, checking the correct behaviour of the outputs by simulating measurement values); the output signal is temporarily invalid (e.g. frozen). |
| | Red | 5 | Failure, error, malfunction | Due to a malfunction of the device or its periphery, the measured values can be incorrect. |

6 TECHNICAL DATA

6.1 Conditions of use

| | |
|---|--|
| Ambient temperature | +0...+40 °C |
| Air humidity | < 90 %, without condensation |
| Protection rating according to EN 60529 | <ul style="list-style-type: none"> • IP65, when plugged in the backplane • IP20, as standalone product |
| Max. height above sea level | 2000 m |

6.2 Conformity to standards and directives

The product conforms to the CE directives of the Type 8905 system, only when the product is plugged in the Type 8905 system.

6.3 Materials the product is made of

| Part | Material |
|---------|---------------|
| Housing | PPE, PPS |
| Seal | EPDM |
| Lever | Zamak painted |

6.4 Fluid data

| | |
|---|--|
| <ul style="list-style-type: none"> • Type of fluid | <ul style="list-style-type: none"> • Water, without particles: drinking water, industrial water |
| <ul style="list-style-type: none"> • pH value | <ul style="list-style-type: none"> • pH 5...pH 9 |
| Minimal flow rate | > 6 l/h |
| Water sample pressure | PN3 |
| Water sample temperature | +3...+40 °C |
| Water sample conductivity | > 100 µS/cm |

6.5 Measurement data

| | |
|---|--|
| pH measurement | |
| <ul style="list-style-type: none"> • Measuring range • Sensor resolution • Measurement deviation ("measurement bias", as defined in the standard JCGM 200:2012) • Linearity • Repeatability • Response time (t_{90}) • Measurement sensor • Electrolyte of the reference electrode | <ul style="list-style-type: none"> • pH 5...pH 9 • pH 0.02 • pH ± 0.1 • pH ± 0.05 • pH ± 0.05 • < 10 s • ISFET • 3 mol KCl |
| Temperature measurement | |
| <ul style="list-style-type: none"> • Measuring range • Measurement sensor | <ul style="list-style-type: none"> • +0...+50 °C • Pt1000 Class B, no contact with the water sample |
| Maintenance interval of the reference electrode | 12 months, nominal, depending on the water quality |

6.6 Electrical data

| | |
|-------------------|---|
| Operating voltage | 24 V DC through the backplane of the Type 8905 system |
| Power consumption | 0.8 VA |

6.7 Communication

| | |
|------------------------|--|
| Internal communication | through bus |
| External communication | Product-status indicator according to NAMUR NE 107 |

7 INSTALLATION

7.1 Safety instructions

NOTICE

Risk of damage to the product due to non-conforming installation.

- The electrical and fluidic installations can only be carried out by qualified and skilled staff with the appropriate tools.
- Respect the installation instructions for the system.

NOTICE

Risk of damage to the product due to the power supply

- Shut down and isolate the electrical power source before carrying out work on the system.

NOTICE

Risk of damage to the product due to the environment

- Protect the product against electromagnetic interference, ultraviolet rays and, when installed outdoors, the effects of the climatic conditions.

7.2 Mounting the product on the backplane

The product is plugged in the backplane of the Type 8905 system.

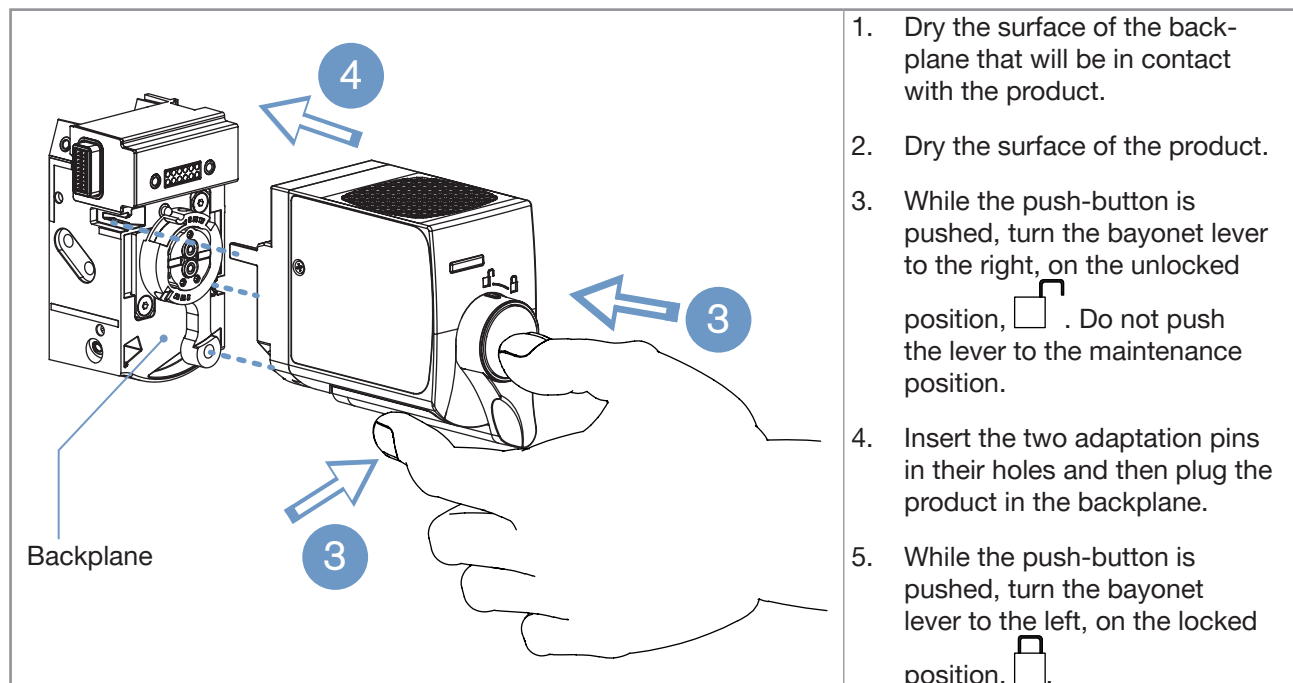



1. Dry the surface of the backplane that will be in contact with the product.
2. Dry the surface of the product.
3. While the push-button is pushed, turn the bayonet lever to the right, on the unlocked position, . Do not push the lever to the maintenance position.
4. Insert the two adaptation pins in their holes and then plug the product in the backplane.
5. While the push-button is pushed, turn the bayonet lever to the left, on the locked position, .

Fig. 3: Mounting a product on the backplane of the system

8 COMMISSIONING

8.1 Safety instructions

NOTICE

Risk of damage to the product due to non-conforming commissioning

- Before commissioning, make sure that the staff in charge have read and fully understood the contents of these Operating Instructions.
- In particular, observe the safety recommendations and intended use.
- The product and the installation must only be commissioned by suitably trained staff.

8.2 First commissioning of the system

1. Let the fluid flow through the system. Make sure that the system is tight.
2. Energize the system.
3. Let the fluid flow through the system for at least 12 hours. Observing this time makes sure that the product and the system operate properly and that the measurements are stable.
4. Check that the process values are measured correctly. If the process values are not correctly measured, use one of the following procedures to calibrate the product:
 - calibration of the offset value. Refer to chpt. [12.1.2](#).
 - calibration of the offset value and of the slope value. Refer to chpt. [12.1.3](#).

9 ADJUSTMENT

9.1 Safety instructions

NOTICE

Risk of damage to the product due to non-conforming adjustment.

- The operators in charge of adjustment must have read and understood the contents of these Operating Instructions.
- The operators in charge of adjustment must have read and understood the contents of the Operating Instructions of the Type ME21 display software and/or the contents of the Operating Instructions of the software Type 8920 Bürkert Communicator and/or the Operating Instructions of the Type ME25 controller module.
- In particular, observe the safety recommendations and intended use.
- The product and the installation must only be adjusted by suitably trained staff.

NOTICE

Risk of damage to the product due to non-conforming operation.

- The operators in charge of operation must have read and understood the contents of these Operating Instructions.
- In particular, observe the safety recommendations and intended use.
- The product and the installation must only be operated by suitably trained staff.

9.2 Adjustment tools and adjustment software

The adjustments can be made with the following tools:

- a PC with the software Type 8920 Bürkert Communicator and the büS stick. To get general information about the Type 8920 software, refer to the Operating Instructions of the Type 8920.
- the Type ME21 touchscreen of the Type 8905 system. To get general information about the Type ME21 touchscreen, refer to the Type ME25 Operating Instructions that are available on the CD delivered with the system and that are also available at country.burkert.com.

These Operating Instructions describe the product-specific adjustments that are made with the Type ME21 touchscreen.

9.3 Description of the user interface

The user interface contains:

- desktop views
- a trend view
- a help view
- a device view.

The desktop views, the trend view and the help view are described in detail in the Type ME25 Operating Instructions. The Type ME25 Operating Instructions give also general information on the software. The Type ME25 Operating Instructions are available on the CD that is delivered with the product and at country.burkert.com.

The Operating Instructions of the product describe the following elements of the user interface:

- the user levels. Refer to chpt. [9.4](#).
- the product functions. Each function has 3 menus. Refer to chpt. [9.5](#).
- the **Messages overview**, overview of the messages that are related to both the system and the product. Refer to chpt. [14.10](#).
- the **Logbook**, overview of the messages that are related to the product. Refer to chpt. [14.10](#).

9.4 Available login user levels

The following 4 login user levels are available:

- the basic user level, which is the level with the least functions,
- the **Advanced User** user level,
- the **Installer** user level,
- the **Bürkert** user level.

By default, the product adjustment is protected by passwords.

[Table 2](#) shows the symbol displayed in the information bar, depending on the user level that is active on the product, and what can be done with each type of user level.

Table 2: Possible login user levels

| Symbol ¹⁾ | User level | Description |
|----------------------|----------------------|---|
| | Basic user | <ul style="list-style-type: none"> • No password is required. • This level is active by default (and by default, password protection is switched off). • The menu items with the symbol enable read-only access. • Not all the menu items that are available with a higher user level are displayed. |
| | Advanced user | <ul style="list-style-type: none"> • Password required, if the password protection is active. Default password is 5678. • The menu items with the symbol enable read-only access. • Not all the menu items that are available with a higher user level are displayed. |
| | Installer | <ul style="list-style-type: none"> • Password required, if the password protection is active. Default password is 1946. • All the available menu items can be adjusted. |
| | Bürkert | <ul style="list-style-type: none"> • Password required, if the password protection is active. • Only for Bürkert service. |

¹⁾ displayed in the information bar, only if the adjustment is protected through passwords

→ If you have forgotten your passwords, you can restore the default passwords with the Type 8920 Bürkert Communicator software. Refer to the related Operating Instructions.



→ If you want to change the passwords, refer to the Type 8920 Operating Instructions.

9.5 Product functions and menus

The product has 2 functions and each function has 3 menus.

To access the product functions and the menus, do the following procedure:

→ Press  that is located under the touchscreen.

→ Select  or  to display the **Device view**. Refer to [Fig. 4](#).

→ Scroll and select the product in the list of devices.

✓ The product functions are displayed.

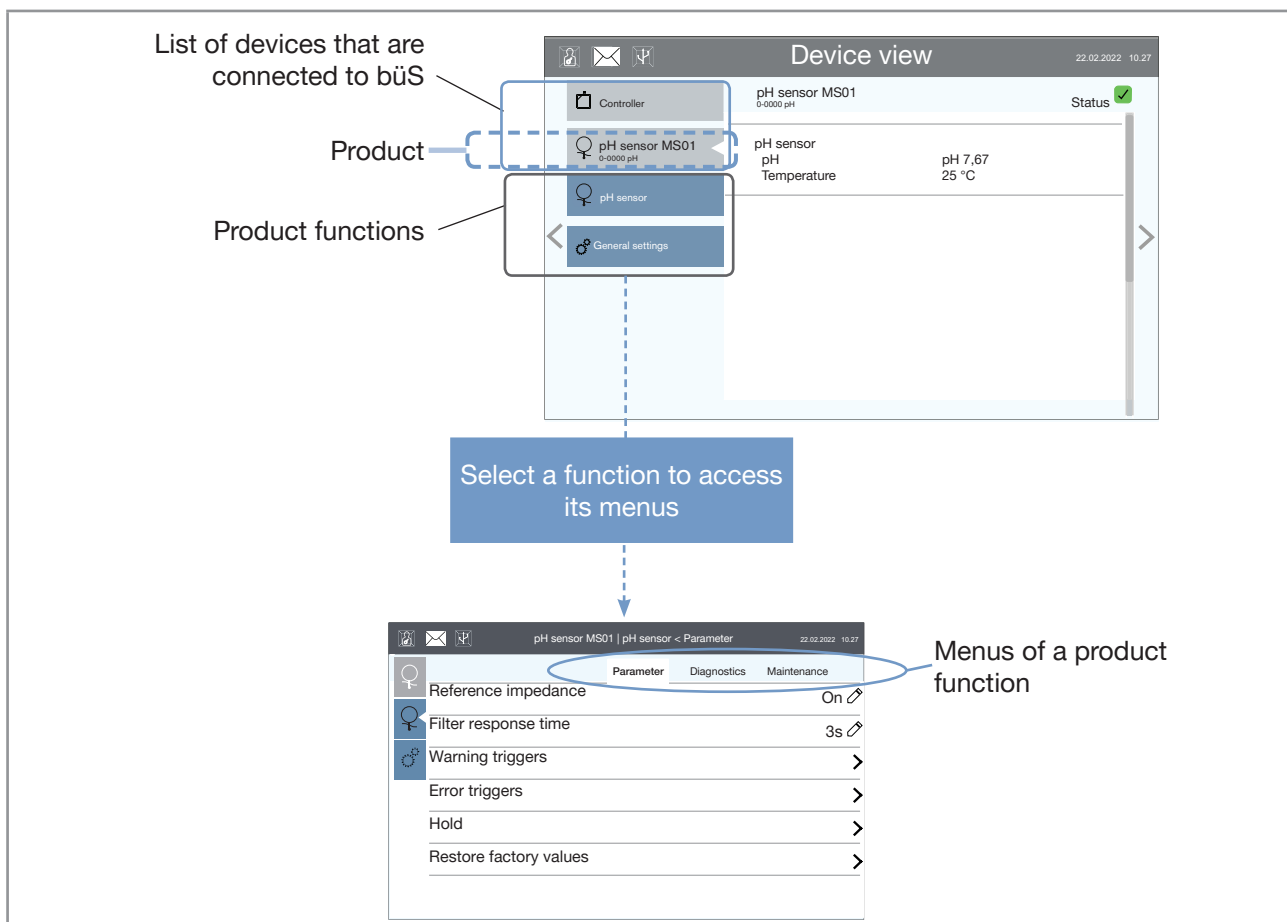

Fig. 4: User interface, product functions

The functions and menus are described in the following chapters:

- Function **pH sensor**, menu **Parameter** in chpt. [10](#).
- Function **pH sensor**, menu **Diagnostics** in chpt. [11](#).
- Function **pH sensor**, menu **Maintenance** in chpt. [12](#).
- Function **General setting**, menu **Parameter** in chpt. [13](#).
- Function **General setting**, menu **Diagnostics** in chpt. [14](#).
- Function **General setting**, menu **Maintenance** in chpt. [15](#).

10 PH SENSOR - PARAMETER

→ Go to device **pH sensor MS01** -----> function **pH sensor** -----> tab **Parameter**. Fig. 5 displays the menu.

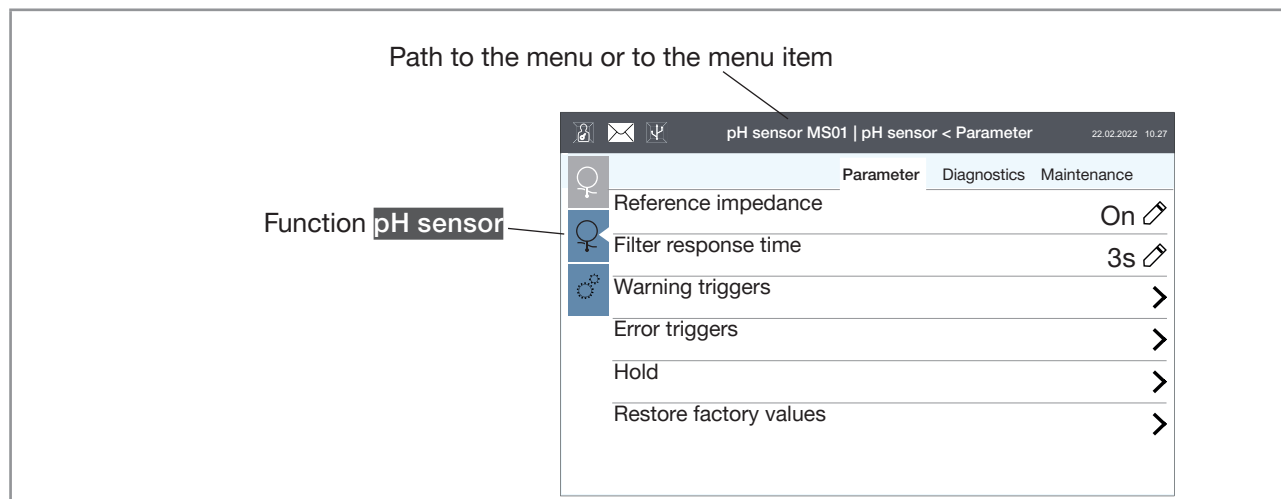

Fig. 5: **Parameter** menu of the function **pH sensor**

The menu items are detailed in the following chapters:

- **Reference impedance**, refer to chpt. [10.1](#) and [10.9](#).
- **Filter response time**, refer to chpt. [10.2](#) and [10.9](#).
- **Warning triggers**, **Error triggers**, refer to chpt. [10.3](#), [10.4](#), [10.5](#), [10.6](#) and [10.10](#).
- **Hold**, refer to chpt. [10.7](#) and [10.9](#).
- **Restore factory values**, refer to chpt. [10.10](#).

10.1 Deactivate or activate the measurement of the impedance value of the reference electrode

The parameter **Reference impedance** makes it possible to activate or deactivate the measurement of the impedance value. By default, the impedance is measured.

→ Make sure that the login user level is **installer**. If necessary, change the user level. Refer to chpt. [9.4](#)

→ Go to device **pH sensor MS01** -----> function **pH sensor** -----> tab **Parameter**.

→ Select **Reference impedance**.

→ To deactivate the measurement of the impedance value, select **Off**.

→ To activate the measurement of the impedance value, select **On**.

→ Validate with .

✓ The impedance value is measured and displayed in the **Diagnostics** tab of the function **pH sensor**.

✓ The impedance value can be monitored. Refer to chpt. [10.3](#).

10.2 Damp or not the variations of the measured pH-values

The parameter **Filter response time** makes it possible to damp or not the variations of the measured pH-values. If the variations of the measured values are not damped, then the raw measured values are sent on the fieldbus.

By default, the parameter **Filter response time** is set to 3 s.

To change the value of the parameter **Filter response time**, do the following procedure:

- Make sure that the login user level is **Installer**. If necessary, change the user level. Refer to chpt. [9.4](#).
- Go to device **pH sensor MS01** -----> function **pH sensor** -----> tab **Parameter**.
- Select **Filter response time**.
- Enter a value between 0 s and 10000 s, depending on your installation. To not damp the variations of the measured values, set the parameter to 0 s. The higher the time value is, the more the variations of the measured values are damped.
- Validate with ✓.
- ✓ If the parameter is set to 0 s, then the variations of the measured values are not damped.
- ✓ If the parameter is set to a value other than 0 s, then the variations of the measured values are damped.

10.3 Monitor the impedance value of the reference electrode

The water pH is correctly measured if the reference electrode is in contact with the water sample. The impedance value of the reference electrode shows whether the electrode is in contact or not with the water sample:

- If the impedance value is less than 160 kΩ, then the reference electrode is in contact with the water sample;
- If the impedance value is between 160 kΩ and 1 MΩ, then the reference electrode is not in contact with the water sample.

You can be warned automatically when the impedance value of the reference electrode is not in contact with the water sample. Do the following procedure:

1. Make sure that the login user level is **Installer**. Refer to chpt. [9.4](#).
2. Activate the measurement of the impedance value of the reference electrode. Refer to chpt. [10.1](#).



Do not configure and activate the low warning limit.

3. **Configure and activate the high warning limit of the impedance value.**

- Go to device **pH sensor MS01** -----> function **pH sensor** -----> tab **Parameter**.
- Select **Warning triggers**.
- Select **High ref. impedance** and enter the impedance value, above which a warning event is generated.
- Validate with ✓.

→ Select **Activation flags**. Select **High ref. impedance**. Validate with ✓.

 Do not configure and activate the low error limit.

4. Configure and activate the high error limit of the impedance value.

→ Go to device **pH sensor MS01** -----> function **pH sensor** -----> tab **Parameter**.

→ Select **Error triggers**.

→ Select **High ref. impedance** and enter the impedance value, above which an error event is generated.
Validate with ✓.

→ Select **Activation flags**. Select **High ref. impedance**. Validate with ✓.

5. Enable the diagnostics. Refer to chpt. [13.11](#).

✓ When the impedance value is more than one of the set limits, a warning event or an error event is generated. Details about the warning event and error event are given in chpt. [19.3.6](#) to [19.3.14](#).

10.4 Monitor the pH value of the water sample

Do the following procedure:

1. Make sure that the login user level is **Installer**. Refer to chpt. [9.4](#).

2. Configure and activate the warning limits of the pH value.

→ Go to device **pH sensor MS01** -----> function **pH sensor** -----> tab **Parameter**.

→ Select **Warning triggers**.

→ Select **Low pH** and enter a pH value, under which a warning event is generated. Validate with ✓.

→ Select **High pH** and enter a pH value, above which a warning event is generated. Validate with ✓.

→ Select **Activation flags**. Select **Low pH** and **High pH**. Validate with ✓.

✓ When the pH value is less than the set limit, a warning event is generated. Details about the warning event are given in chpt. [19.3.9](#).

✓ If the pH value is more than the set limit, then a warning event is generated. Details about the warning event are given in chpt. [19.3.10](#).

3. Configure and activate the error limits of the pH value.

→ Go to device **pH sensor MS01** -----> function **pH sensor** -----> tab **Parameter**.

→ Select **Error triggers**.

→ Select **Low pH** and enter a pH value, under which an error event is generated. Validate with ✓.

→ Select **High pH** and enter a pH value, above which an error event is generated. Validate with ✓.

→ Select **Activation flags**. Select **Low pH** and **High pH**. Validate with ✓.

✓ When the pH value is less than the set limit, an error event is generated. Details about the error event are given in chpt. [19.3.1](#).

✓ When the pH value is more than the set limit, an error event is generated. Details about the error event are given in chpt. [19.3.2](#).

→ To enable the monitoring, i.e. to be informed when the pH value is outside the normal range, enable the diagnostics. See chpt. [13.11](#).

10.5 Monitor the temperature value of the water sample

Do the following procedure:

1. Make sure that the login user level is **installer**. Refer to chpt. [9.4](#).

2. Configure and activate the warning limits of the temperature value.

→ Go to device **pH sensor MS01** -----> function **pH sensor** -----> tab **Parameter**.

→ Select **Warning triggers**.

→ Select **Low temperature** and enter a temperature value, under which a warning event is generated. Validate with ✓.

→ Select **High temperature** and enter a temperature value, above which a warning event is generated. Validate with ✓.

→ Select **Activation flags**. Select **Low temperature** and **High temperature**. Validate with ✓.

✓ When the temperature value is less than the set limit, a warning event is generated. Details about the warning event are given in chpt. [19.3.11](#).

✓ When the temperature value is more than the set limit, a warning event is generated. Details about the warning event are given in chpt. [19.3.12](#).

3. Configure and activate the error limits of the temperature value.

→ Go to device **pH sensor MS01** -----> function **pH sensor** -----> tab **Parameter**.

→ Select **Error triggers**.

→ Select **Low temperature** and enter a temperature value, under which an error event is generated. Validate with ✓.

→ Select **High temperature** and enter a temperature value, above which an error event is generated. Validate with ✓.

→ Select **Activation flags**. Select **Low temperature** and **High temperature**. Validate with ✓.

✓ When the temperature value is less than the set limit, an error event is generated. Details about the error event are given in chpt. [19.3.3](#).

✓ When the temperature value is more than the set limit, an error event is generated. Details about the error event are given in chpt. [19.3.4](#).

→ To enable the monitoring, i.e. to be informed when the temperature value of the water sample is outside the normal range, enable the diagnostics. See chpt. [13.11](#).

10.6 Monitor the leakage-current value of the measuring cell

The leakage current is the current that is required for the correct operation of the measuring cell. The value of the leakage current is specific to each measuring cell and, thus, to each product. Upon delivery, the product has a specific leakage-current value. Deterioration of the measuring cell causes the value of the leakage current to increase. If the value of the leakage current reaches 4 times the initial value in absolute value, then the measuring cell is out of order.

The parameter **ISFET leakage current** makes it possible to monitor the leakage-current value. Do the following procedure:

1. Make sure that the login user level is **installer**. Refer to chpt. [9.4](#).



Do not configure and activate the low warning limit.

2. Configure and activate the high warning limit of the leakage-current value.

→ Go to device **pH sensor MS01** -----> function **pH sensor** -----> tab **Parameter**.

→ Select **Warning triggers**.

→ Select **High ISFET leak. current** and enter a leakage-current value, above which a warning event is generated. Validate with ✓.

→ Select **Activation flags**. Select **High ISFET leak. current**. Validate with ✓.

✓ When the leakage-current value is more than the set limit, a warning event is generated. Details about the warning event are given in chpt. [19.3.16](#).

 Do not configure and activate the low error limit.

3. Configure and activate the high error limit of the leakage-current value.

→ Go to device **pH sensor MS01** -----> function **pH sensor** -----> tab **Parameter**.

→ Select **Error triggers**.

→ Select **High ISFET leak. current** and enter a leakage-current value, above which an error event is generated. Validate with ✓.

→ Select **Activation flags**. Select **High ISFET leak. current**. Validate with ✓.

✓ When the leakage-current value is more than the set limit, an error event is generated. Details about the error event are given in chpt. [19.3.8](#).

→ To enable the monitoring, i.e. to be informed when the leakage-current value is outside the normal range, enable the diagnostics. See chpt. [13.11](#).

10.7 Freeze the values that are transmitted on the fieldbus

The product makes it possible to temporarily freeze the values that are sent by the product on the fieldbus. You can choose one of the following options:

- If you want to manually freeze the values, refer to chpt. [10.7.1](#).
- If you want to automatically freeze the values, for example with a special event that is considered as a trigger, refer to chpt. [10.7.2](#). The special event is for example a cleaning operation of the product with the Type MZ20 cleaning system.

10.7.1 Manual freeze

→ Make sure that the login user level is **Installer**. Refer to chpt. [9.4](#).

→ Go to device **pH sensor MS01** -----> function **pH sensor** -----> tab **Parameter**.

→ Select **Hold**

1. Choose the values to be sent on the fieldbus:

- If you want to send the last-measured values, do the following procedure:

→ Select **Action** -----> **Last values**.

- If you want to send user-specific values, do the following procedure:

→ Select **Action** -----> **User values**.

→ Select **pH** and enter a pH value. Validate with ✓.

→ Select **Temperature** and enter a temperature value. Validate with ✓.

2. Activate the parameter **Hold** :

→ Select **Mode** -----> **On**. Validate with ✓.

✓ The following actions are carried out:

- The product-status indicator is orange.
- The bit 2 of the pH-State byte is set to 1. The updated value of the pH-State byte is sent on the fieldbus. Refer to chpt. 16.3.
- The chosen values are sent on the fieldbus.

10.7.2 Automatic freeze

The product makes it possible to stop the measurements temporarily during a special event. You can only select one special event. A special event is triggered by a binary event.

Do the following procedure:

→ Make sure that the login user level is **Installer**. Refer to chpt. 9.4.

→ Go to device **pH sensor MS01** -----> function **pH sensor** -----> tab **Parameter**.

→ Select **Hold**

1. Choose the values to be sent on the fieldbus

• If you want to send the last-measured values, do the following procedure:

→ Select **Action** -----> **Last values**.

• If you want to send user-specific values, do the following procedure:

→ Select **Action** -----> **User values**.

→ Select **pH** and enter a pH value. Validate with ✓.

→ Select **Temperature** and enter a temperature value. Validate with ✓.

2. Select the binary event

→ Select **Select data source**. The view **Device connections** is displayed. See Fig. 6.

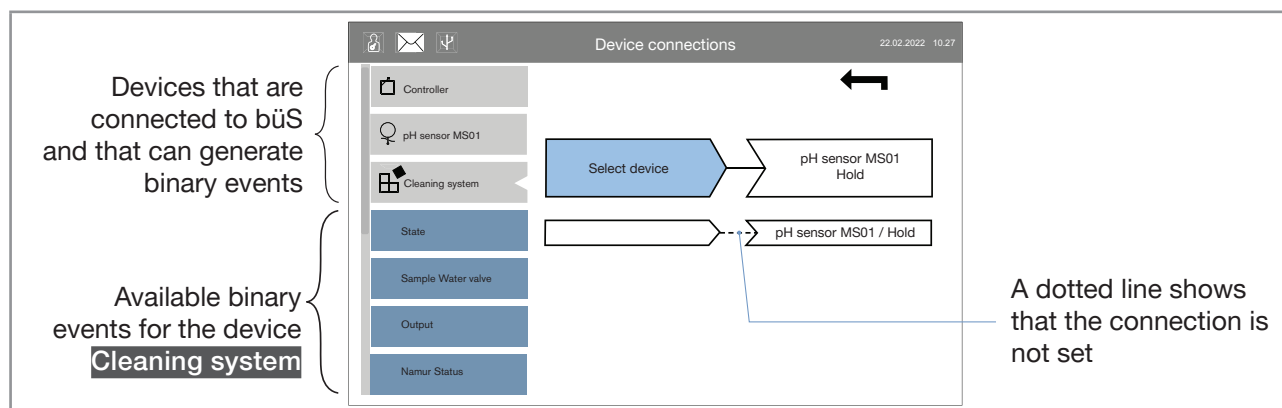

Fig. 6: **Device connections** view

→ Select a device in the list. The available binary events are displayed.

→ Select the binary event. Validate with ✓.

! The next step restarts the product.

→ Select **Finish** to set the connection. The product restarts.

→ Go to the **Device connections** view to make sure that the connection is set. Refer to Fig. 7.

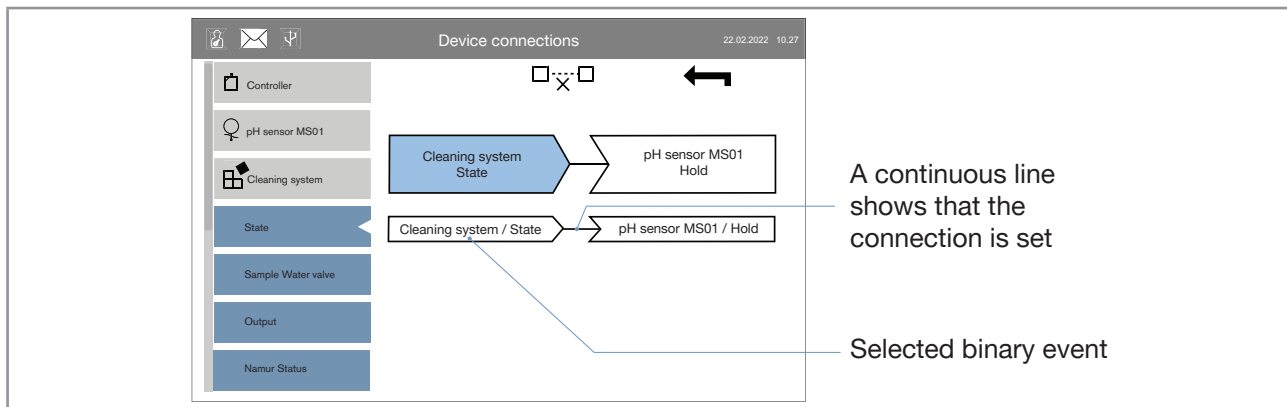

Fig. 7: **Device connections** view - Connection set

! If the device that can generate the binary event is not connected to būs, then the connection is broken and the message **būs event: producer not found** is displayed, whether the parameter **Hold** is activated or not. To restore the connection, refer to chpt. 19.1.3.

3. Activate the parameter **Hold**

→ Select **Mode** -----> **External**. Validate with ✓.

✓ As soon as the selected binary event is activated, the following actions are carried out:



- The product-status indicator is orange.
- The bit 2 of the pH-State byte is set to 1. The updated value of the pH-State byte is sent on the fieldbus. Refer to chpt. 16.3.
- The chosen values are sent on the fieldbus.

✓ As soon as the selected binary event is deactivated, the following actions are carried out:

- The product sends the measured values on the fieldbus.
- The product-status indicator is green.
- The bit 2 of the pH-State byte is set to 0. The updated value of the pH-State byte is sent on the fieldbus. Refer to chpt. 16.3.

10.7.3 Change the binary event for the automatic freeze

To change the binary event that is connected to the product, do the following procedure:



- Make sure that the login user level is **Installer**. Refer to chpt. [9.4](#).
- Go to device **pH sensor MS01** -----> function **pH sensor** -----> tab **Parameter**.
- Select **Hold** -----> **Select data source**.
- Select  to delete the connection.
- If needed, select another binary event. Confirm with **Finish**.
- Select  to take the changes into account.



The next step restarts the product.

- Select **Finish** to restart the product.

10.8 Stop the manual freeze or the automatic freeze

- Make sure that the login user level is **Installer**. Refer to chpt. [9.4](#).
 - Go to device **pH sensor MS01** -----> function **pH sensor** -----> tab **Parameter**.
 - Select **Hold** -----> **Mode** -----> **Off** Validate with .
-  As soon as the parameter **Hold** is deactivated, the following actions are carried out:
- The product sends the measured values on the fieldbus.
 - The product-status indicator is green.
 - The bit 2 of the pH-State byte is set to 0. The updated value of the pH-State byte is sent on the fieldbus. Refer to chpt. [16.3](#).

10.9 Restore some parameters to their factory values

You can restore the parameters in [Table 3](#) to their factory values.

Table 3: List of parameters

| Device | Function | Tab | Parameter |
|----------------|-----------|-----------|-------------------------|
| pH sensor MS01 | pH sensor | Parameter | Reference impedance |
| | | | Filter response time |
| | | | Hold -----> Mode |
| | | | Hold -----> Action |
| | | | Hold -----> pH |
| | | | Hold -----> Temperature |

- Make sure that the login user level is **Installer**. Refer to [chpt. 9.4](#).
- Go to device **pH sensor MS01** -----> function **pH sensor** -----> tab **Parameter**.
- Select **Restore factory values**.
- Select **Parameter**. Confirm with **Finish**.
- ✓ The parameters in [Table 3](#) are set to their default values.

10.10 Deactivate the monitoring of all the parameters, set the threshold values to their factory values

- Make sure that the login user level is **Installer**. Refer to [chpt. 9.4](#).
- Go to device **pH sensor MS01** -----> function **pH sensor** -----> tab **Parameter**.
- Select **Restore factory values**.
- Select **Messages triggers**. Confirm with **Finish**.
- ✓ The monitoring of all the parameters is deactivated and the threshold values are set to their factory values.

11 PH SENSOR - DIAGNOSTICS

→ Go to device **pH sensor MS01** -----> function **pH sensor** -----> tab **Diagnostics**. The menu shows only read-only values. [Table 4](#) shows the values.

Table 4: Description of the parameters

| Parameter | Description | |
|------------------------------|--|--|
| pH | Measured value of the pH of the water sample in pH unit | |
| pH voltage | Measured value of the pH of the water sample in mV | |
| Isfet offset | Offset value of the measuring cell, in mV, determined by factory calibration | |
| pH offset | Offset value of the pH sensor, in pH unit. The value is determined by factory calibration, through user calibration or entered in the Maintenance tab. | |
| pH slope | Slope value of the pH sensor, in mV/pH. The value is determined by factory calibration, through user calibration or entered in the Maintenance tab. | |
| Temperature | Measured value of the water sample temperature in K | |
| RTD sensor | Measured value of the water sample temperature in Ω | |
| Temperature offset | Temperature offset, in $^{\circ}\text{C}$. The value is determined by factory calibration, through user calibration or entered in the Maintenance tab. | |
| pH state | Decimal value of the pH State byte. See chpt. 16.3 | |
| pH state | Detailed description of the pH State byte. See chpt. 16.3 | |
| PCB temperature | Measured value of the temperature of the electronics, in $^{\circ}\text{C}$ | |
| Reference impedance | Measured impedance of the reference electrode in Ω | |
| VDS | Value of the operating voltage of the measuring cell (about 500 mV) | |
| Offset | Offset value of the operating voltage of the measuring cell (about -1.8 V) | |
| I drain | Value of the drain current of the measuring cell (about 100 μA) | |
| I source | Value of the source current of the measuring cell (about 100 μA) | |
| ISFET leakage current | Measured value of the leakage current of the measuring cell, in nA | |
| Cell working time | Time in hours, during which the measuring cell has already operated | |
| Isfet offset limits | Warning limit low | Warning and error limits of the offset value of the measuring cell. These values cannot be changed. |
| | Warning limit high | |
| | Error limit low | |
| | Error limit high | |
| Slope limits | Warning limit low | Warning and error limits for the calibration-curve slope-value of the pH sensor. These values cannot be changed. |
| | Warning limit high | |
| | Error limit low | These values are the acceptance criteria that are used for the calibration of the product. Refer to chpt. 12.1.2 or chpt. 12.1.3 . |
| | Error limit high | |
| Offset limits | Warning limit low | Warning and error limits for the calibration-curve offset-value of the pH sensor. These values cannot be changed. |
| | Warning limit high | |
| | Error limit low | These values are the acceptance criteria that are used for the calibration of the product. Refer to chpt. 12.1.2 or 12.1.3 . |
| | Error limit high | |

12 PH SENSOR - MAINTENANCE

→ Go to device **pH sensor MS01** -----> function **pH sensor** -----> tab **Maintenance**. Fig. 8 displays the menu.

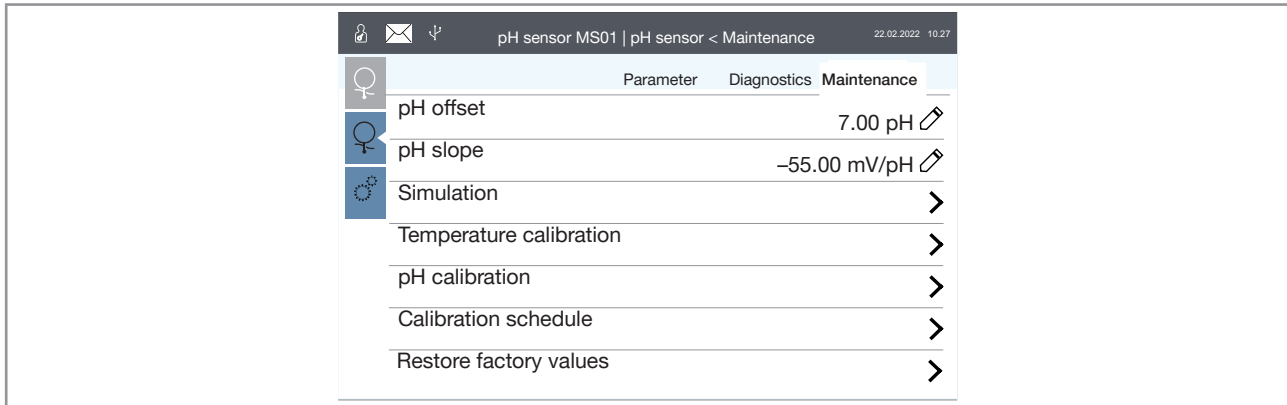

Fig. 8: **Maintenance** menu of the function **pH sensor**

The menu items are detailed in the following chapters:

- **pH offset**, **pH slope**, refer to chpt. [12.1](#).
- **Simulation**, refer to chpt. [12.4](#) and [12.5](#).
- **Temperature calibration**, refer to chpt. [12.2](#).
- **pH calibration**, refer to chpt. [12.1](#).
- **Calibration schedule**, refer to chpt. [12.3](#).
- **Restore factory values**, refer to chpt. [12.6](#) and [12.7](#).

12.1 Calibration of the pH sensor

Calibration of the pH sensor is required to measure pH values with as less deviation as possible.

→ Calibrate the product every 3 months with one of the following means:

- Adjust by hand the slope value and the offset value of the pH-sensor calibration-curve. Refer to chpt. [12.1.1](#).
- Do a 1-point calibration procedure to automatically adjust the offset value of the pH-sensor calibration-curve. Refer to chpt. [12.1.2](#).
- Do a 2-point calibration procedure to automatically adjust the offset value and the slope value of the pH-sensor calibration-curve. Refer to chpt. [12.1.3](#).

12.1.1 Manually calibrate the pH sensor

→ Make sure that the login user level is **Installer**. Refer to chpt. [9.4](#).

→ Go to device **pH sensor MS01** -----> function **pH sensor** -----> tab **Maintenance**.

→ Select **pH offset** and enter a pH value. Validate with ✓.

✓ The new offset value is used by the product. The offset value is updated in the **Diagnostics** tab.

→ Select **pH slope** and enter a value. Validate with ✓.

✓ The new slope value is used by the product. The slope value is updated in the **Diagnostics** tab.

12.1.2 1-point calibration procedure of the pH sensor

CAUTION



Risk of injury due to the nature of the operating agents

- ▶ Respect the prevailing regulations on accident prevention and safety relating to the use of dangerous fluids.
- ▶ Observe the information on the safety data sheet. The safety data sheets can be found at:
 - Cleaning solution acid: <http://sds-id.com/200111-2>
 - Cleaning solution alkaline: <http://sds-id.com/200112-1>
 - Flushing solution (reagent): <http://sds-id.com/200116-7>
 - Buffer solution pH 5: <http://sds-id.com/200113-0>
 - Buffer solution pH 7: <http://sds-id.com/200114-19>
 - Buffer solution pH 9: <http://sds-id.com/200115-8>
- ▶ Wear personal protective equipment when working with cleaning solutions.
- ▶ Dispose of waste containing chemicals produced by the system in an environmentally friendly manner.

Prerequisites:

- Buy a Type MZ15 handheld calibration-and-cleaning tool with article number 00568805.
- Buy a büS extension-cable. Refer to [Table 5](#). If needed, buy a Y junction.

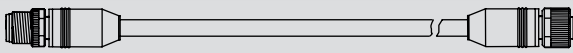
Table 5: Accessories: cables and connectors

| Accessories | Article number |
|--|----------------|
| büS extension-cable with 5-pin M12 connectors, 0.5 m | 772403 |
| büS extension-cable with 5-pin M12 connectors, 1 m | 772404 |
| büS extension-cable with 5-pin M12 connectors, 3 m | 772405 |
| büS extension-cable with 5-pin M12 connectors, 5 m | 772406 |
|  | |
| Y junction | 772420 |
|  | |

- Buy a buffer solution with a pH value as close as possible to the water sample. Refer to [Table 6](#).

Table 6: Accessories: buffer solution

| Accessories | Article number |
|--|----------------|
| Buffer solution pH 5.00 (20 °C), 50 ml | 806698 |
| Buffer solution pH 7.00 (20 °C), 50 ml | 806699 |
| Buffer solution pH 9.00 (20 °C), 50 ml | 806700 |

- Read the Type MZ15 Operating Instructions.
- Observe the information on the safety data sheets for the used solutions. The relevant data sheet can be found at the address given on the bottom of the bottle.
- For a correct use of the Type MZ15 handheld calibration-and-cleaning tool, refer to the Operating Instructions of the Type MZ15.
- Unlock and remove the product from the on the backplane of the system.
- Plug the product on the Type MZ15 handheld calibration-and-cleaning tool. Refer to the Operating Instructions of the Type MZ15
- If necessary, unscrew the termination resistance from the Type 8905 system and screw the termination resistance on the Y junction. Refer to the Operating Instructions of the Type MZ15.

Start the calibration procedure:

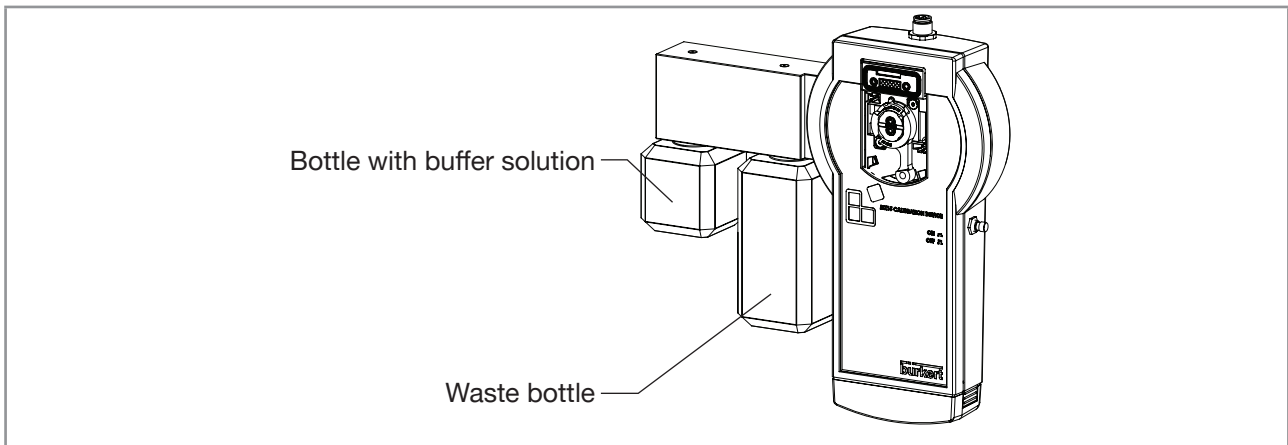

Fig. 9: Handheld calibration-and-cleaning tool: position of the bottle with the buffer solution and position of the waste bottle

- Screw the bottle with the buffer solution as shown in [Fig. 9](#). Refer to the Operating Instructions of the Type MZ15.
- Make sure that the login user level is at least **Advanced user**. Refer to [chpt. 9.4](#).
- Go to device **pH sensor MS01** -----> function **pH sensor** -----> tab **Maintenance**.
- Select **pH calibration** -----> **1 point**.
- ✔ The product-status indicator flashes.

Do the calibration procedure:



→ Keep the Type MZ15 handheld calibration-and-cleaning tool upright during calibration procedure to make sure that both of the conditions are met:

- The buffer solution flows correctly through the product.
- The check valves operate correctly.

Step 1/5:

→ To let the buffer solution flow through the product, press the actuator button of the Type MZ15.

→ Select **Next**.

Step 2/5:

→ Select **Input value of buffer solution**.

→ Enter the pH value of the buffer solution.

→ Validate with ✓.

→ Select **Next**.

Step 3/5:

→ When the pH measurement is stable, select **Next**.

Step 4/5:

There are 3 possible results:

- The calibration succeeds.
- The message **Error: Value out of range** is displayed.
- The message **Warning: Value out of range** is displayed.

Calibration successful

If the calibration has succeeded, you have two options:

- Accept the new offset value. Select **Save** and go to the step 5/5.
- ✓ The new offset value is displayed.
- ✓ The date of the last calibration is updated. See chpt. [12.3](#).
- Reject the new offset value. Select **Cancel** and do a new calibration.

Message Error: Value out of range

The calibration has failed because the calculated offset value is out of its error range. Do the following procedure:

1. Replace the reference electrode by a new one. Refer to chpt. 17.5.
2. Do the calibration again.
3. If the calibration fails again, then replace the measuring cell of the product. Refer to chpt. 17.6.
4. Do the calibration again.
5. If the calibration fails again, then replace the product by a new one.

Message Warning: Value out of range

The calculated offset value is out of the warning range. Do the following procedure:

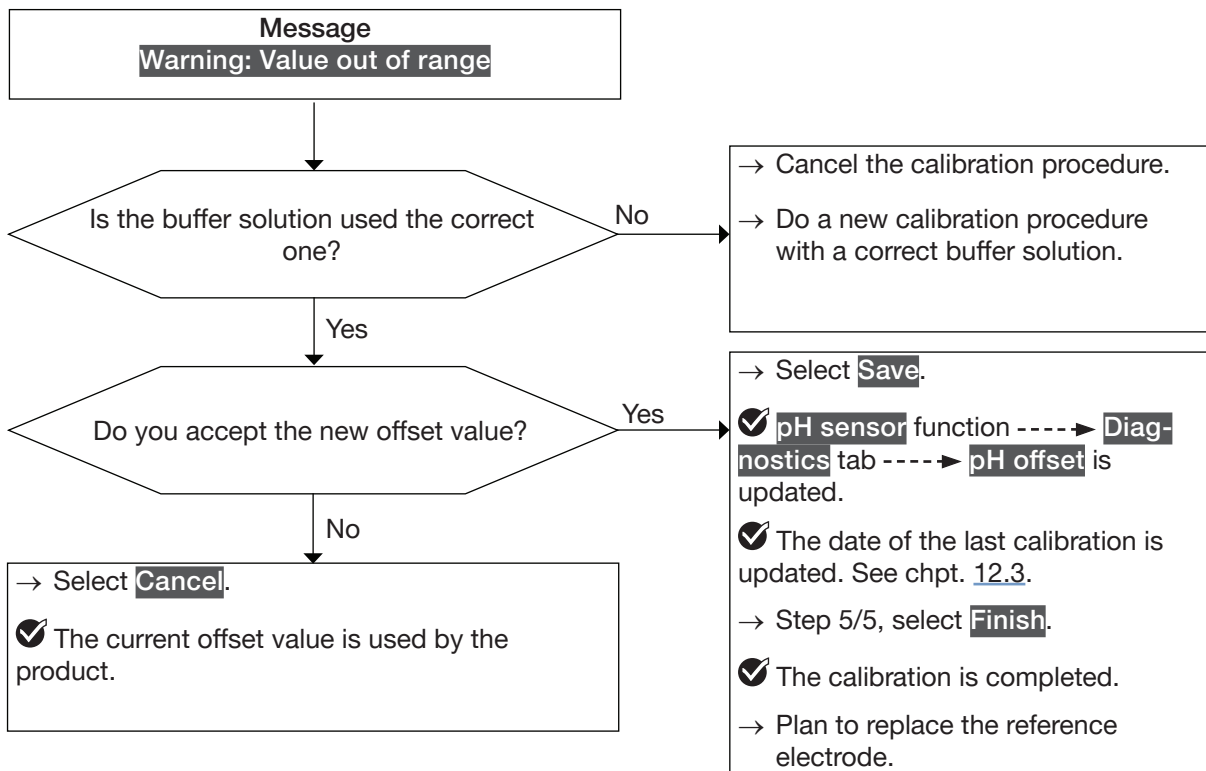

Fig. 10: Message **Warning: Value out of range** is displayed during a 1-point calibration procedure

Step 5/5:

The calibration is completed.

→ Select **Finish**.

- ✓ The offset value of the pH-sensor calibration-curve is validated.

Plug the product back on the backplane:

1. Replace the bottle with the buffer solution by a bottle with tap water.
2. Press the actuator button in order to rinse the product.
3. Unscrew the bottle with tap water.
4. Press the actuator button in order to allow air to dry the fluid system of the product.
5. Remove the product from the Type MZ15.
6. Insert and lock the product back on the backplane of the system.
7. Remove the büS extension-cable between the Type MZ15 and the system. Refer to the Operating Instruction of the Type MZ15.
8. If necessary, screw back the termination resistance to its initial place on the system Type 8905.

12.1.3 2-point calibration procedure of the pH sensor

CAUTION



Risk of injury due to the nature of the operating agents

- ▶ Respect the prevailing regulations on accident prevention and safety relating to the use of dangerous fluids.
- ▶ Observe the information on the safety data sheet. The safety data sheets can be found at:
 - Cleaning solution acid: <http://sds-id.com/200111-2>
 - Cleaning solution alkaline: <http://sds-id.com/200112-1>
 - Flushing solution (reagent): <http://sds-id.com/200116-7>
 - Buffer solution pH 5: <http://sds-id.com/200113-0>
 - Buffer solution pH 7: <http://sds-id.com/200114-19>
 - Buffer solution pH 9: <http://sds-id.com/200115-8>
- ▶ Wear personal protective equipment when working with cleaning solutions.
- ▶ Dispose of waste containing chemicals produced by the system in an environmentally friendly manner.

Prerequisites:

- Buy a Type MZ15 handheld calibration-and-cleaning tool with article number 00568805.
- Buy a büS extension-cable. Refer to [Table 7](#). If needed, buy a Y junction.

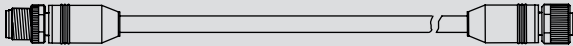
Table 7: Accessories: cables and connectors

| Accessories | Article number |
|--|----------------|
| büS extension-cable with 5-pin M12 connectors, 0.5 m | 772403 |
| büS extension-cable with 5-pin M12 connectors, 1 m | 772404 |
| büS extension-cable with 5-pin M12 connectors, 3 m | 772405 |
| büS extension-cable with 5-pin M12 connectors, 5 m | 772406 |
|  | |
| Y junction | 772420 |
|  | |

- Buy a buffer solution with pH 5, article number 806698 and a buffer solution with pH 9, article number 806700.

- Read the Type MZ15 Operating Instructions.
- Observe the information on the safety data sheets for the used solutions. The relevant data sheet can be found at the address given on the bottom of the bottle.
- For a correct use of the Type MZ15 handheld calibration-and-cleaning tool, refer to the Operating Instructions of the Type MZ15.
- Unlock and remove the product from the on the backplane of the system.
- Plug the product on the Type MZ15 handheld calibration-and-cleaning tool. Refer to the Operating Instructions of the Type MZ15

→ If necessary, unscrew the termination resistance from the Type 8905 system and screw the termination resistance on the Y junction. Refer to the Operating Instructions of the Type MZ15.

Start the calibration procedure:

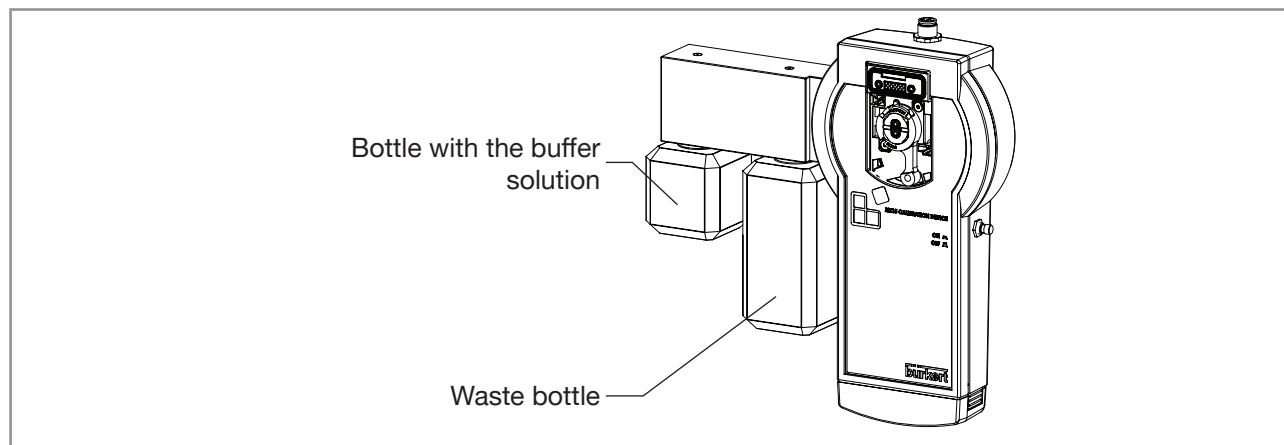

Fig. 11: Handheld calibration-and-cleaning tool: position of the bottle with the buffer solution and position of the waste bottle

→ Screw the bottle with the first buffer solution as shown in Fig. 11. Refer to the Operating Instructions of the Type MZ15.

→ Make sure that the login user level is at least **Advanced user**. Refer to chpt. 9.4.

→ Go to device **pH sensor MS01** -----> function **pH sensor** -----> tab **Maintenance**.

→ Select **pH calibration** -----> **2 point**.

✓ The product-status indicator flashes.

Do the calibration procedure:

! → Keep the Type MZ15 handheld calibration-and-cleaning tool upright during calibration procedure to make sure that both of the conditions are met:

- The buffer solution flows correctly through the product.
- The check valves operate correctly.

Step 1/9:

→ To let the first buffer solution flow through the product, press the actuator button of the Type MZ15.

→ Select **Next**.

Step 2/9:

→ Select **Input value of buffer solution 1**.

→ Enter the pH value of the first buffer solution.

→ Validate with ✓.

→ Select **Next**.

Step 3/9:

→ When the pH measurement is stable, select **Next**.

Step 4/9:

- Replace the bottle with the buffer solution by a bottle with tap water.
- Press the actuator button in order to rinse the product.
- Unscrew the bottle with tap water.
- Press the actuator button in order to allow air to dry the fluid system of the product.
- To flush the product, refer to the Operating Instructions of the Type MZ15.

Step 5/9:

- Screw the bottle with the second buffer solution as shown in [Fig. 11](#).
- To let the second buffer solution flow through the product, press the actuator button of the Type MZ15.
- Select **Next**.

Step 6/9:

- Select **Input value of buffer solution 2**.
- Enter the pH value of the second buffer solution.
- Validate with .
- Select **Next**.

Step 7/9:

→ When the pH measurement is stable, select **Next**.

Step 8/9:

3 possibilities:

- The calibration succeeds.
- The message **Error: Value out of range** is displayed.
- The message **Warning: Value out of range** is displayed.

Calibration successful

If the calibration has succeeded, you have two options:

- Accept the new offset value and the new slope value. Select **Save** and go to the step 9/9.
- ✔ The new offset value and the new slope value are displayed.
- ✔ The date of the last calibration is updated. See chpt. [12.3](#).
- Reject the new offset value and the new slope value. Select **Cancel** and do a new calibration.

Message **Error: Value out of range**

The calibration has failed because the calculated offset value or the calculated slope value are out of their error ranges.

→ To find which value is out of its error range, refer to tab **Diagnostics** -----> **Slope limits** and tab **Diag-nostics** -----> **Offset limits**.

- If the slope value is out of its error range, then do the following procedure:
 1. Replace the measuring cell of the product. Refer to chpt. [17.6](#).
 2. Do the calibration again.
 3. If the calibration fails again, then send the product back to Bürkert.
- If the offset value is out of its error range, then do the following procedure:
 1. Replace the reference electrode by a new one. Refer to chpt. [17.5](#).
 2. Do the calibration again.
 3. If the calibration fails again, replace the measuring cell of the product. Refer to chpt. [17.6](#).
 4. Do the calibration again.
 5. If the calibration fails again, then send the product back to Bürkert.

Message **Warning: Value out of range**

The calculated offset value is out of the warning range or the calculated slope value is out of the warning range. Do the following procedure:

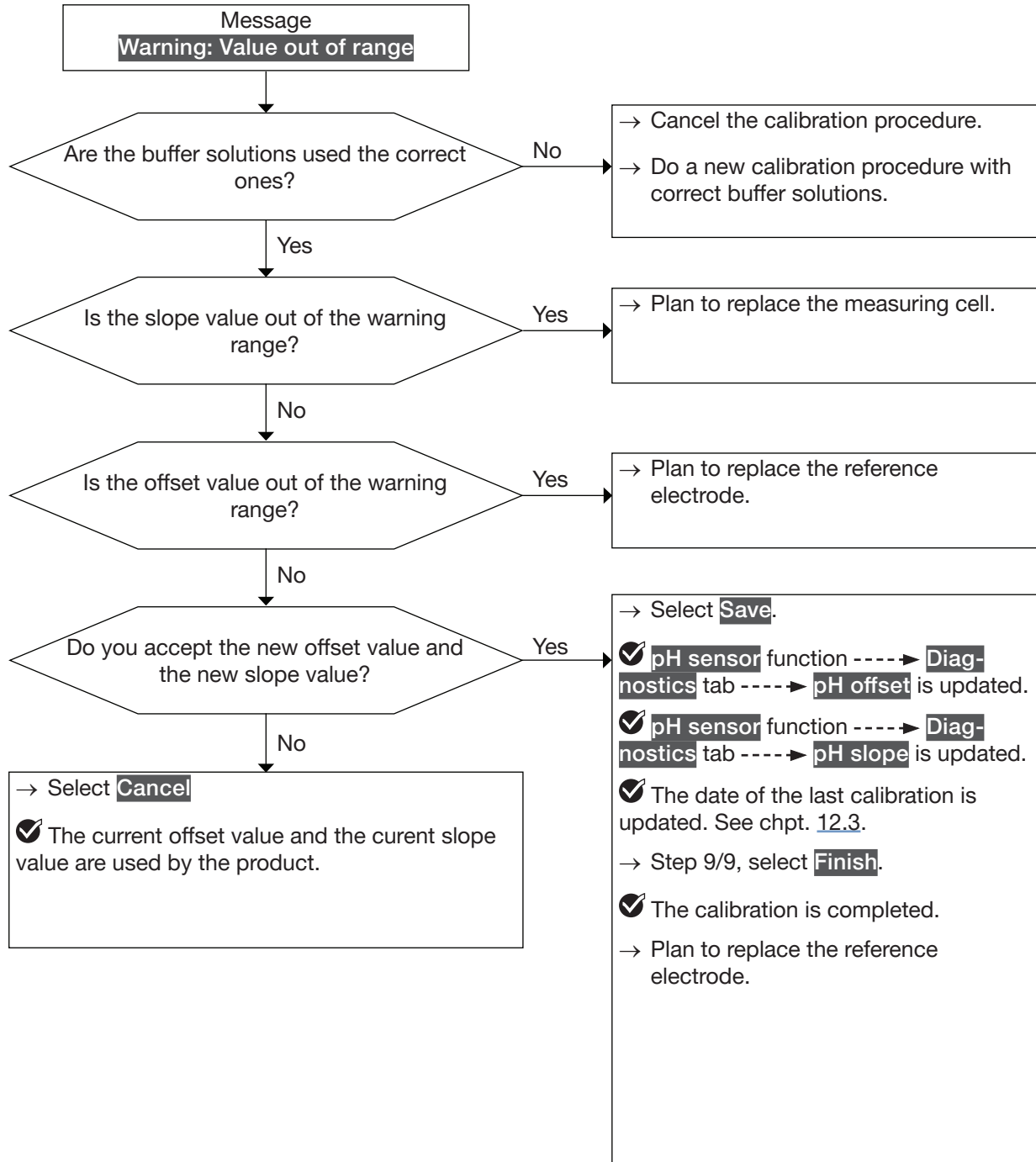

Fig. 12: Message **Warning: Value out of range** is displayed during a 2-point calibration procedure

Step 9/9:

The calibration is completed.

→ Select **Finish**.

✔ The offset value and the slope value of the pH-sensor calibration-curve are validated.

Plug the product back on the backplane:

1. Replace the bottle with the buffer solution by a bottle with tap water.
2. Press the actuator button in order to rinse the product.
3. Unscrew the bottle with tap water.
4. Press the actuator button in order to allow air to dry the fluid system of the product.
5. Remove the product from the Type MZ15.
6. Insert and lock the product back on the backplane of the system.
7. Remove the büS extension-cable between the Type MZ15 and the system. Refer to the Operating Instruction of the Type MZ15.
8. If necessary, screw back the termination resistance to its initial place on the system Type 8905.

12.1.4 Connect the Type MZ15 calibration-and-cleaning tool to the Type 8905 system that has no Type ME21 touchscreen

→ Buy the USB-büS-interface set with article number 00772426 from Bürkert. See [Fig. 13](#).

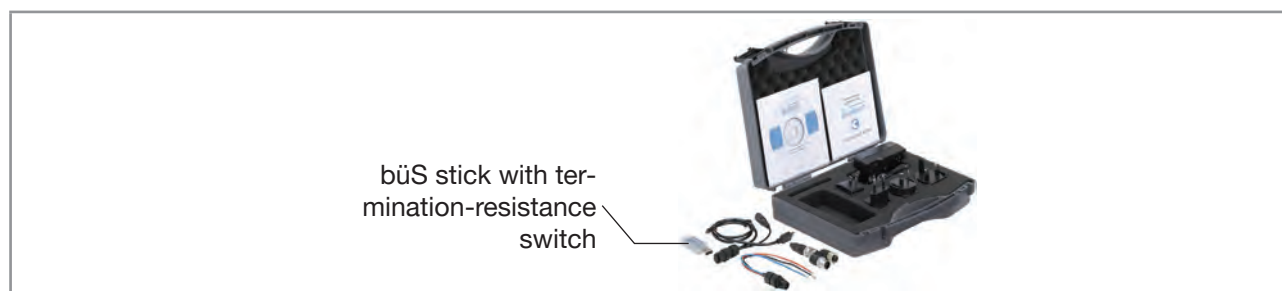

Fig. 13: USB-büS-interface set with article number 00772426

→ Download the latest version of the Type 8920 Bürkert-Communicator software from country.burkert.com.

→ During installation, the büS stick must not be inserted at the PC. Install the Bürkert-Communicator software on a PC. Obey the installation recommendations given in the USB-büS-interface set.

[Fig. 14](#) shows the electrical connection parts that are used from the USB-büS-interface set.

→ Insert the micro-USB connector into the büS stick.

→ Insert the appropriate power adapter into the AC/DC adapter.

→ Connect the jack male-connector of the AC/DC-adaptor cable to the jack female-connector of the M12 female-connector cable.

→ Connect the M12 female connector to the büS network.

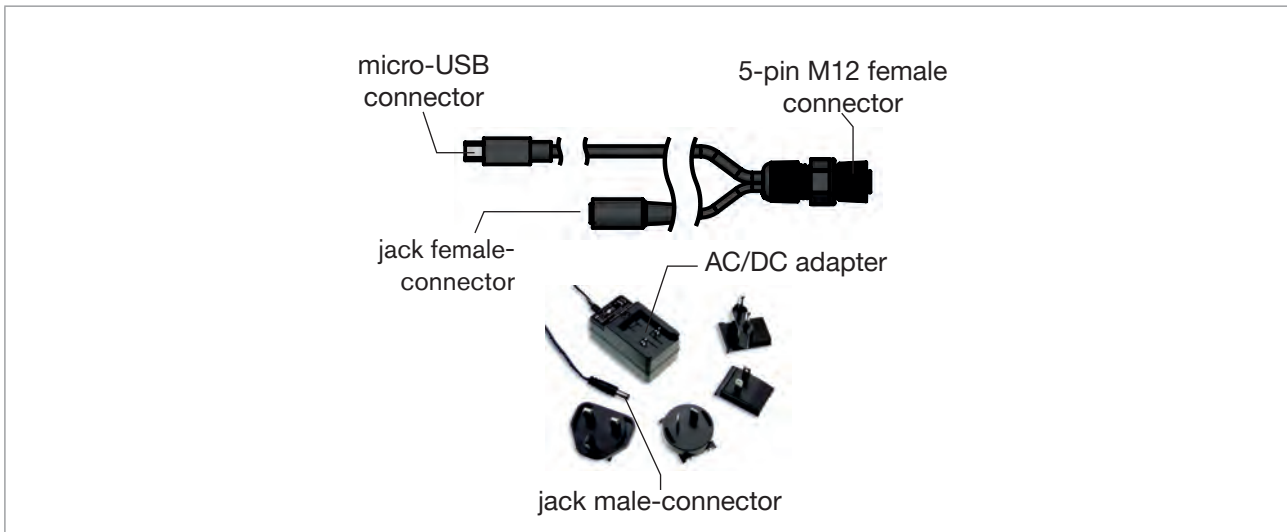



Fig. 14: Electrical connection parts of the USB-büS-interface set with article number 00772426

- If the Type MZ15 is connected to one or the other end of büS, then set the termination-resistance switch of the büS stick to ON. Else set the termination-resistance switch of the büS stick to OFF.
- Insert the büS stick into a USB port of the PC.
- Wait until the Windows pilot of the büS stick has been completely installed on the PC.
- Connect the AC/DC adapter to the power supply.
- Start the Bürkert-Communicator software.
- Click on  in the Bürkert-Communicator software to establish the communication between the Bürkert-Communicator software and the product. A window opens.
- Select **büS-Stick**.
- Choose the port **Bürkert büS Stick**, click on **Finish** and wait until the product symbol appears in the list of devices.
- In the list of devices, click on the symbol related to the product: the menu structure for the product is displayed.

12.2 Manually calibrate the temperature sensor

The temperature measured by the sensor can be corrected with an offset value.

- Make sure that the login user level is **Advanced user**. Refer to chpt. 9.4.
- Go to device **pH sensor MS01** -----> function **pH sensor** -----> tab **Maintenance**.
- Select **Temperature calibration**.
- Select **Offset** and enter a temperature value in °C. Validate with ✓.
- ✓ The new offset value is used by the product.
- ✓ The offset value is updated in the **Diagnostics** tab.

12.3 Plan the calibrations

→ Go to device **pH sensor MS01** -----> function **pH sensor** -----> tab **Maintenance**.

→ Select **Calibration schedule**.

The field **Last** indicates the date of the last 1-point or 2-points calibration procedure that has succeeded.

The field **Next** indicates the date of the next calibration procedure that must be done.

If you want to change the time interval between two calibrations, do the following procedure:

→ Make sure that the login user level is **Installer**. Refer to chpt. [9.4](#).

→ Select **Interval in days**.

→ Enter the number of days between two calibration procedures. Bürkert recommends to calibrate the product every 3 months.

→ Validate with .

 The date that is displayed in the field **Next** is automatically calculated.

 When the due calibration date is reached, following happens:

- The product-status indicator is blue.
- The message **Calibration date has expired** is displayed in the **Messages overview**. To read the message, select  in the top of the display. Refer to chpt. [14.10](#).
- The bit 1 of the pH-State byte is set to 1. The updated value of the pH-State byte is sent on the fieldbus. Refer to chpt. [16.3](#).

12.4 Check the correct behaviour of the system and the product

To check the correct behaviour of the system, do the following procedure:

- Make sure that the login user level is **Installer**. Refer to chpt. [9.4](#).
- Go to device **pH sensor MS01** -----> function **pH sensor** -----> tab **Maintenance**.
- Select **Simulation** -----> **Status** -----> **On**. Validate with ✓.
- ✓ As soon as the parameter **Simulation** -----> **Status** is set to **On**, the following actions are carried out:
 - The product is in a simulation mode and stops measuring.
 - The product-status indicator is orange.
 - The bit 2 of the pH-State byte is set to 1. The updated value of the pH-State byte is sent on the fieldbus. Refer to chpt. [16.3](#).

To check the correct behaviour of the product and the system, do the following procedure:

- Select **pH** and enter a pH value. Validate with ✓.
- ✓ The product sends the entered pH-value and the displayed temperature-value on the fieldbus.
- Make sure that the product and the system behave depending on the pH value and the temperature value that are both displayed in the **Simulation** parameter window.
- Select **Temperature** and enter a temperature value. Validate with ✓.
- ✓ The product sends the entered temperature-value and the displayed pH-value on the fieldbus.
- Make sure that the product and the system behave depending on the pH value and the temperature value that are both displayed in the **Simulation** parameter window.

12.5 Stop the simulation mode

Go to device **pH sensor MS01** -----> function **pH sensor** -----> tab **Maintenance**.

- Select **Simulation** -----> **Status** -----> **Off** Validate with ✓.
- ✓ As soon as the parameter **Simulation** -----> **Status** is set to **Off**, the following actions are carried out:
 - The product measures again.
 - The product-status indicator is green.
 - The bit 2 of the pH-State byte is set to 0. The updated value of the pH-State byte is sent on the fieldbus. Refer to chpt. [16.3](#).

12.6 Restore the offset value of the temperature to its factory value

- Make sure that the login user level is **Installer**. Refer to chpt. [9.4](#).
- Go to device **pH sensor MS01** -----> function **pH sensor** -----> tab **Maintenance**.
- Select **Restore factory values**.
- Select **Temperature**. Confirm with **Finish**.

✔ The offset value of the temperature is set to its factory value.

12.7 Restore the offset value and the slope value of the pH-sensor calibration-curve to their factory values

- Make sure that the login user level is **Installer**. Refer to chpt. [9.4](#).
- Go to device **pH sensor MS01** -----> function **pH sensor** -----> tab **Maintenance**.
- Select **Restore factory values**.
- Select **pH calibration**. Confirm with **Finish**.

✔ The offset value and the slope value of the pH-sensor calibration-curve are set to their factory values.

13 GENERAL SETTINGS - PARAMETER

→ Go to device **pH sensor MS01** -----> function **General settings** -----> tab **Parameter**. Fig. 15 displays the menu.

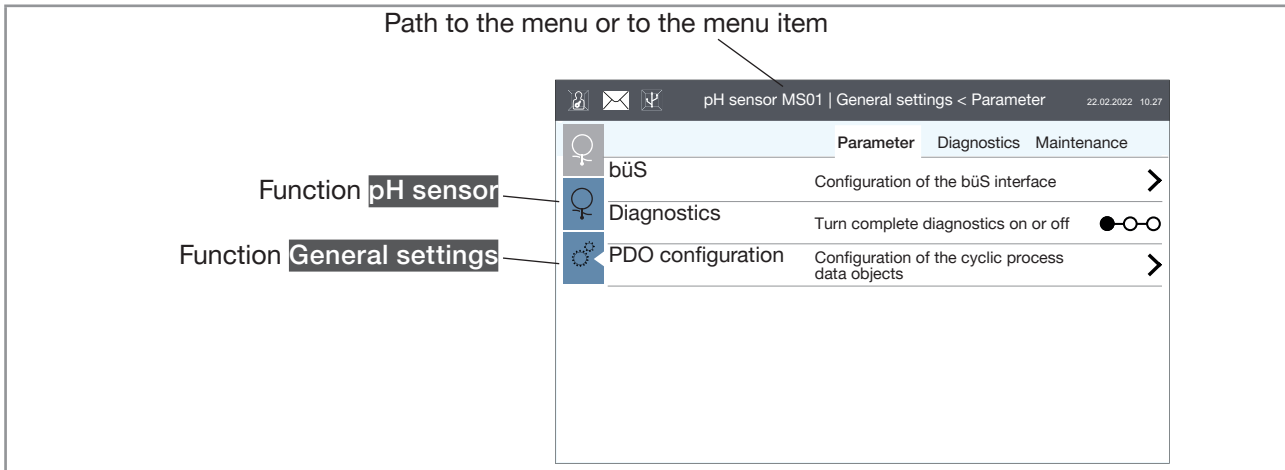

Fig. 15: **Parameter** menu of the function **General settings**

The menu items are detailed in the following chapters:

- **bÜS**, refer to chpt. [13.1](#), [13.2](#), [13.3](#), [13.4](#), [13.5](#), [13.6](#), [13.7](#), [13.8](#), [13.9](#) and [13.10](#).
- **Diagnostics**, refer to chpt. [13.11](#).
- **PDO configuration**, refer to chpt. [13.12](#) and [13.13](#)

13.1 Enter a name for the product

The entered name will be shown on any display connected to bÜS. Refer to Fig. 16.

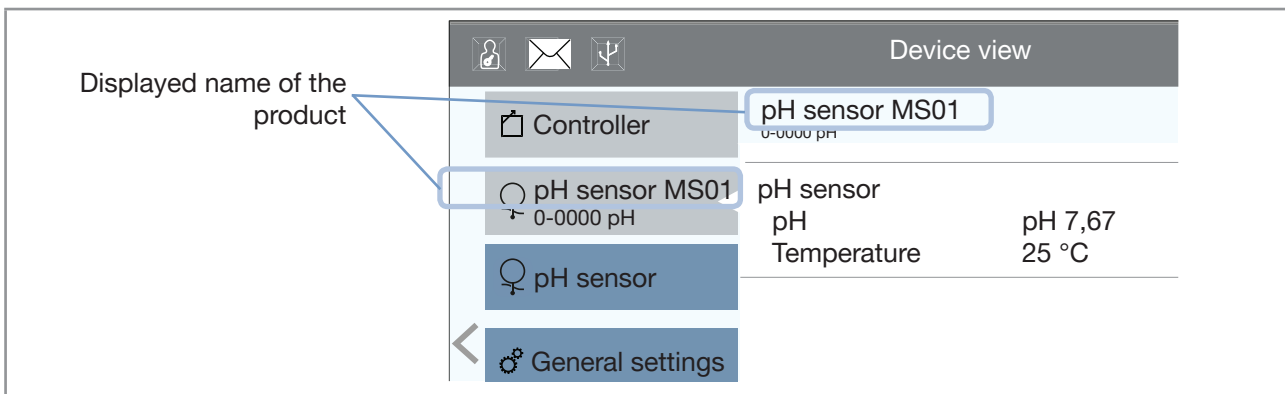

Fig. 16: *Device view of the product*

To enter the name of the product, do the following procedure:

- Make sure that the login user level is **Installer**. Refer to chpt. [9.4](#).
- Go to device **pH sensor MS01** -----> function **General settings** -----> tab **Parameter**.
- Select **bÜS** -----> **Displayed name** and enter a name.
- Validate with ✓.
- ✓ The name is set.

13.2 Enter the location of the product

The entered location will be shown on any display connected to büS. Refer to [Fig. 17](#).

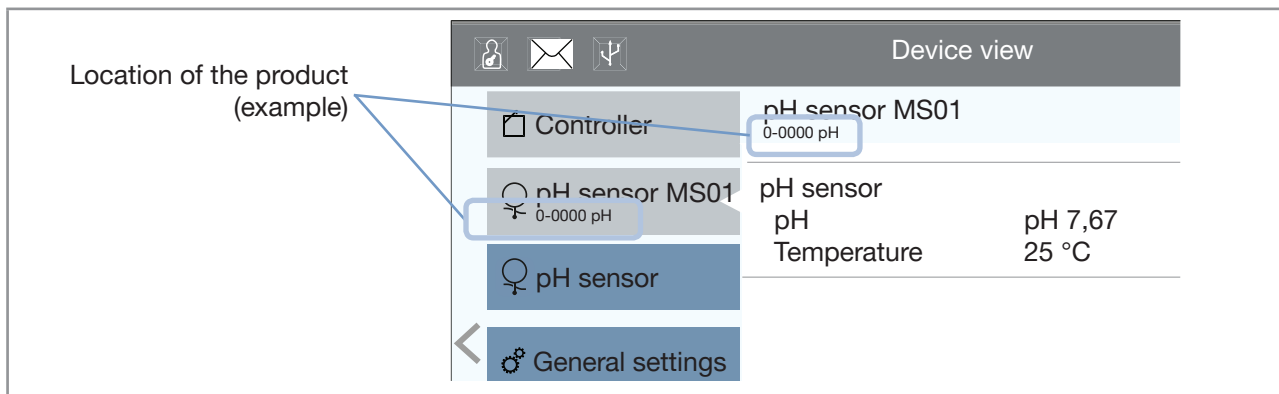

Fig. 17: Device view of the product

To enter the information where the product is located, do the following procedure:

- Make sure that the login user level is **Installer**. Refer to [chpt. 9.4](#).
- Go to device **pH sensor MS01** -----> function **General settings** -----> tab **Parameter**.
- Select **büS** -----> **Location** and enter a location.
- Validate with ✓.
- ✓ The location is set.

13.3 Enter a description for the product

The description allows you to precisely identify the product. To enter a description for the product, do the following procedure:

- Make sure that the login user level is **Installer**. Refer to [chpt. 9.4](#).
- Go to device **pH sensor MS01** -----> function **General settings** -----> tab **Parameter**.
- Select **büS** -----> **Description** and enter the description.
- Validate with ✓.
- ✓ The description is set.



13.4 Enter a unique name for the product

The unique name of the product is used by the other fieldbus participants. The fieldbus participants can use the data provided by the product on the fieldbus. For example, a Type ME25 controller-module can display the water pH-value, given by the product.

If the unique name is changed, then the participant loses the link to the product and the participant generates the error **büS event: producer not found**. The link between the participant and the product must then be restored.

Bürkert recommends not to change the unique name of the product. By default, the unique name is composed with product article-number and serial number.

To change the unique name, do the following procedure:



- Make sure that the login user level is **Installer**. Refer to chpt. [9.4](#).
- Go to device **pH sensor MS01** -----> function **General settings** -----> tab **Parameter**.
- Select **büS** -----> **Advanced** -----> **Unique device name** and enter the name (max. 19 characters).
- Save the name with .
-  The unique name is set.
- Restart the product to take the unique name into account.
- If a participant was linked to the product, restore the link in the settings of the participant.

13.5 Change the transmission speed of the product

The transmission speed for the communication on the fieldbus (büS or CANopen) must be the same for all the participants of the fieldbus.

By default, the transmission speed of the product is set to 500 kbit/s.

To change the transmission speed, do the following procedure:

- Make sure that the login user level is **Installer**. Refer to chpt. [9.4](#).
- Go to device **pH sensor MS01** -----> function **General settings** -----> tab **Parameter**.
- Select **büS** -----> **Advanced** -----> **Baud rate** and choose the transmission speed.
- Validate with .
-  The transmission speed of the product is changed.
- Restart the product to take the transmission speed into account.

13.6 Address of a product connected to bÜS

If the product is connected to bÜS, bÜS automatically addresses the product. By default, the address of the product on bÜS is 11.

13.7 Change the address of the product connected to a CANopen fieldbus

By default, the address of the product connected to a CANopen fieldbus is 11.

To attribute an available address to the product, do the following procedure:

- Make sure that the login user level is **Installer**. Refer to chpt. 9.4.
- Go to device **pH sensor MS01** -----> function **General settings** -----> tab **Parameter**.
- Select **bÜS** -----> **Advanced** -----> **CANopen address**.
- Enter an available address in the parameter **CANopen address**.
- Validate with ✓.
- ✓ The address of the product is set.
- Restart the product to take the set address into account.

13.8 Set the digital communication for bÜS or for a CANopen fieldbus

By default, the operating mode of the digital communication is set to **bÜS** and the measured process data (PDOs, process data objects) is sent on a connected fieldbus.

The other operating modes of the digital communication are **CANopen** or **Standalone**.

If the product is connected to bÜS or to a CANopen fieldbus, do the following to change the operating mode of the digital communication:

- Make sure that the login user level is **Installer**. Refer to chpt. 9.4.
- Go to device **pH sensor MS01** -----> function **General settings** -----> tab **Parameter**.
- Select **bÜS** -----> **Advanced** -----> **Bus mode**.
- Select the operating mode **bÜS** or **CANopen**.
- Validate with ✓.
- ✓ The operating mode of the digital communication is changed.
- ✓ If the operating mode of the digital communication is set to **bÜS** or to **CANopen**, the PDOs are sent to the connected fieldbus.
- Restart the product to take the operating mode of digital communication into account.

13.9 Stop sending the measured process data (PDOs) to büS or to the CANopen fieldbus

If the product is connected to büS or to a CANopen fieldbus and you want to temporarily stop sending the PDOs to büS or to the CANopen fieldbus, do the following procedure:

- Make sure that the login user level is **Installer**. Refer to chpt. 9.4.
- Go to device **pH sensor MS01** -----> function **General settings** -----> tab **Parameter**.
- Select **büS** -----> **Advanced** -----> **Bus mode**.
- Select **Standalone**.
- Validate with ✓.
- Restart the product to take the operating mode of digital communication into account.

✓ The PDOs are no more sent to the connected fieldbus.

13.10 Change the time to check the presence of a participant on the fieldbus

Bürkert recommends not to change the parameter **Deallocation delay** of the product. By default, the parameter value is set to 500 ms.

To change the parameter value, do the following procedure:

- Make sure that the login user level is **Installer**. Refer to chpt. 9.4.
- Go to device **pH sensor MS01** -----> function **General settings** -----> tab **Parameter**.
- Select **büS** -----> **Advanced** -----> **Deallocation delay** and enter a value in ms.
- Validate with ✓.
- Restart the product to take the new value into account.





✓ The new value is set.

13.11 Disable or enable the diagnostics

- If the diagnostics are enabled, the product gives information about the following items:
 - Monitoring of the measurement values.
 - Monitoring of product-internal parameters.
 - Status of the communication with the connected fieldbus.

By default, the diagnostics are enabled. The product status are shown according to [Table 8](#).

Table 8: Product status if the diagnostics are enabled

| Product-status indicator | Colour code (for a PLC) | Displayed symbol | Description | Meaning | |
|--------------------------|-------------------------|------------------|---|---|--|
| Colour | Red | 5 |  | Failure, error, malfunction | Due to a malfunction of the product or its periphery, the measured values can be incorrect |
| | Orange | 4 |  | Function check | Ongoing work on the product. For example, simulating measurement values. |
| | Yellow | 3 |  | Out of specification | At least one of the monitored parameters is outside its monitored limits. |
| | Blue | 2 |  | Maintenance required | The product is in controlled operation; however, the function is briefly restricted. → Do the required maintenance operation. |
| | Green | 1 |  | Diagnostics active and no event has been generated | Messages are listed and possibly transmitted through any connected fieldbus. |
| Flashing rapidly | - | - | Identification | The product is selected using a man-machine interface, for example the Bürkert Communicator software. | |

- If the diagnostics are disabled, the product status changes are not shown. Refer to [Table 9](#).

Table 9: Product status if the diagnostics are disabled

| Product-status indicator | Colour code (for a PLC) | Displayed symbol | Description | Meaning |
|--------------------------|-------------------------|------------------|----------------------|---|
| White | 0 | | Diagnostics inactive | Messages are neither listed nor transmitted through any connected fieldbus. |
| Flashing rapidly | - | - | Identification | The product is selected using a man-machine interface, for example the Bürkert Communicator software. |

To disable or enable the diagnostics, do the following procedure:

- Make sure that the login user level is **Installer**. Refer to chpt. 9.4.
- Go to device **pH sensor MS01** -----> function **General settings** -----> tab **Parameter**.
- Select **Diagnostics**.

Step 1/3

- To disable the diagnostics, select **Off**. To enable the diagnostics, select **On**.
- Validate with ✓ and select **Save**.

Step 2/3

 **The confirmation of your choice restarts the product.**

- To cancel the procedure, select **Cancel**.
- To change your choice, select **Back**.
- To confirm your choice, select **Next**.

Step 3/3: The product restarts.

13.12 Set the transmission time between 2 values of a PDO

The process data objects (PDO) are cyclic data sent from the product to the other participants of the fieldbus or received by the product from other participants to the fieldbus. For more information about the structure of the PDO, refer to chpt. 16.3.

The transmission time between 2 values of a PDO is described by the 2 following parameters:

- the value of the parameter **Event timer** is the time after which the product sends the value of the same PDO, even if the value did not change. It enables a periodical transmission of the PDO.
- the value of the parameter **Inhibit time** is the minimum time between the sending of 2 different PDOs.

The product transmits the following PDOs:

- PDO1, see [Table 10](#).

Table 10: PDO1 - Transmitted data and their default values

| Name | Unit SI | Range | Event timer (ms) | Inhibit time (ms) |
|------------|---------|--------------|------------------|-------------------|
| pH | pH | pH -2...16 | 1000 | 100 |
| pH voltage | V | -2,5...2,5 V | 1000 | 100 |

- PDO2, see [Table 11](#).

Table 11: PDO2 - Transmitted data and their default values

| Name | Unit SI | Range | Event timer (ms) | Inhibit time (ms) |
|---------------------------------------|---------|----------|------------------|-------------------|
| Impedance of the reference electrode | Ω | 0...1 MΩ | 1000 | 100 |
| Leakage current of the measuring cell | A | - | 1000 | 100 |

- PDO3, see [Table 12](#).

Table 12: PDO3 - Transmitted data and their default values

| Name | Unit SI | Range | Event timer (ms) | Inhibit time (ms) |
|---------------------------------|---------|-------------|------------------|-------------------|
| Temperature of the water sample | K | 233...398 K | 5000 | 100 |

- PDO4, see [Table 13](#).

Table 13: PDO4 - Transmitted data and their default values

| Name | Unit SI | Range | Event timer (ms) | Inhibit time (ms) |
|----------|---------|-------|------------------|-------------------|
| pH state | - | - | 5000 | 100 |

The product receives from other participants to the fieldbus the PDO1 described in [Table 14](#).

Table 14: Received PDO1 and its default values

| Name | Unit SI | Range | Event timer (ms) | Inhibit time (ms) |
|------|---------|-------|------------------|-------------------|
| Hold | - | - | - | - |

To set the transmission time between 2 values of the PDO, do the following procedure:

- Make sure that the login user level is **Installer**. Refer to chpt. [9.4](#).
- Go to device **pH sensor MS01** -----> function **General settings** -----> tab **Parameter**.
- Select **PDO configuration** -----> **PDO 1**, **PDO 2**, **PDO 3** or **PDO 4**
- Select **Inhibit time** and enter a value in ms. Validate with ✓.
- Select **Event timer** and enter a value in s. Validate with ✓.

✓ The selected PDO is configured.

13.13 Restore all PDOs to their default values

- Make sure that the login user level is **Installer**. Refer to chpt. [9.4](#).
- Go to device **pH sensor MS01** -----> function **General settings** -----> tab **Parameter**.
- Select **PDO configuration**.
- Select **Reset to default values**.
- Validate with **Next**. The product restarts.

✓ The PDOs are set to their default values.

14 GENERAL SETTINGS - DIAGNOSTICS

→ Go to device **pH sensor MS01** -----> function **General settings** -----> tab **Diagnostics**. Fig. 18 displays the menu.

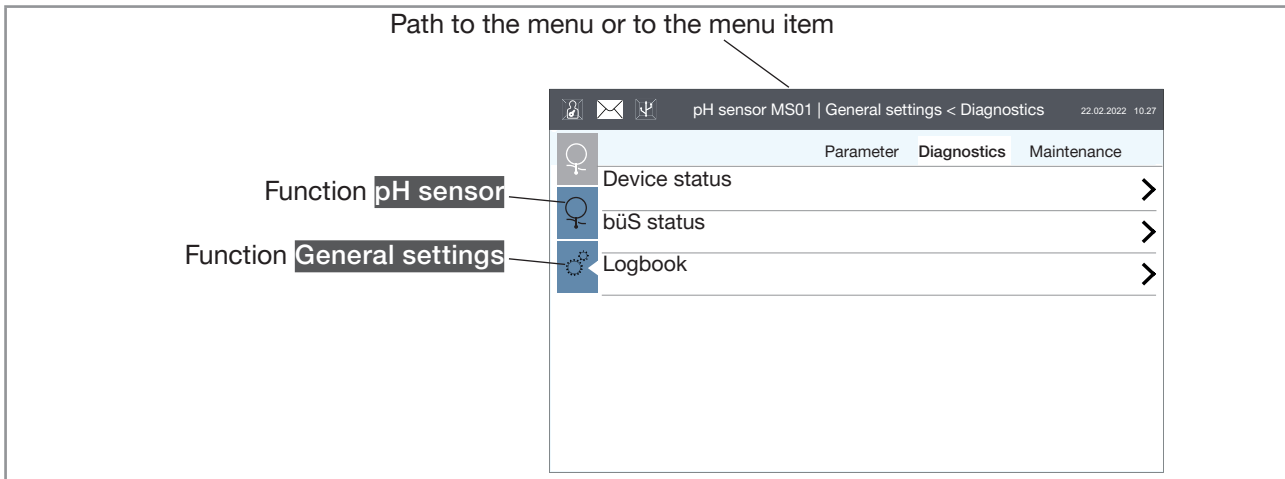

Fig. 18: **Diagnostics** menu of the function **General settings**

The menu items are detailed in the following chapters:

- **Device status**, refer to chpt. [14.1](#), [14.2](#) and [14.3](#).
- **bÜS status**, refer to chpt. [14.4](#), [14.5](#), [14.6](#), [14.7](#), [14.8](#) and [14.9](#).
- **Logbook**, refer to chpt. [14.10](#).

14.1 Read the number of product starts

→ Go to device **pH sensor MS01** -----> function **General settings** -----> tab **Diagnostics**.

→ Select **Device status**.

- ✓ The parameter **Device boot counter** indicates the number of restarts of the product.

14.2 Check the presence of the memory card

You can check if the memory card is inserted in its product slot without removing the product from the backplane. For more information on the memory card, refer to chpt. [5.3](#).

→ Go to device **pH sensor MS01** -----> function **General settings** -----> tab **Diagnostics**.

→ Select **Device status**.

→ Read the parameter **Transferable memory status**.

- If you read **Memory available**, the memory card is inserted in the product.
- If you read **Memory not available**, no memory card is inserted in the product.

14.3 Read the current time

→ Go to device **pH sensor MS01** -----> function **General settings** -----> tab **Diagnostics**.

→ Select **Device status**.

✓ The parameter **Current system time** indicates the current time of the system.

14.4 Read the number of current receive errors

→ Make sure that the login user level is at least **Advanced user**. Refer to chpt. 9.4.

→ Go to device **pH sensor MS01** -----> function **General settings** -----> tab **Diagnostics**.

→ Select **büS status**.

→ Read the value of the parameter **Receive errors**.

14.5 Read the maximum number of receive errors since the last power-up of the device

→ Make sure that the login user level is at least **Advanced user**. Refer to chpt. 9.4.

→ Go to device **pH sensor MS01** -----> function **General settings** -----> tab **Diagnostics**.

→ Select **büS status**.

→ Read the value of the parameter **Receive errors max.**

14.6 Read the number of current transmit errors

→ Make sure that the login user level is at least **Advanced user**. Refer to chpt. 9.4.

→ Go to device **pH sensor MS01** -----> function **General settings** -----> tab **Diagnostics**.

→ Select **büS status**.

→ Read the value of the parameter **Transmit errors**.

14.7 Read the maximum number of transmit errors since the last power-up of the device

→ Make sure that the login user level is at least **Advanced user**. Refer to chpt. 9.4.

→ Go to device **pH sensor MS01** -----> function **General settings** -----> tab **Diagnostics**.

→ Select **büS status**.

→ Read the value of the parameter **Transmit errors max.**

14.8 Reset the 2 maximum error counters

To reset the 2 maximum error counters, do the following procedure:

→ Make sure that the login user level is **Installer**. Refer to chpt. 9.4.

- Go to device **pH sensor MS01** -----> function **General settings** -----> tab **Diagnostics**.
- Select **büS status**.
- Select **Reset error counter**.
- Confirm with **save** or cancel with **cancel**.
- ✔ The 2 maximum error counters are reset.

14.9 Read whether the measured process data is sent on büS or on the CANopen fieldbus

To read out whether the measured process data (PDO, process data object) is sent on büS or on the CANopen fieldbus, do the following procedure:

- Go to device **pH sensor MS01** -----> function **General settings** -----> tab **Diagnostics**.
- Select **büS status** and read the value of the parameter **CANopen status**.
- If the **CANopen status** is **Operational**, the PDOs are sent to büS or to the CANopen fieldbus.
- If the **CANopen status** is **Pre-Op** (pre-operational), the PDOs are not sent on büS or on the CANopen fieldbus and the message **büS is not operational** is generated in the message list. Refer to chpt. 19.1.4.

14.10 Read the generated events

2 types of events can be generated: events that are related both to the system and to the product and events that are related to the product.

- To read the events that are related both to the system and to the product, do the following procedure:
- Select  in the top of the display.
- ✔ The **Messages overview** is displayed.

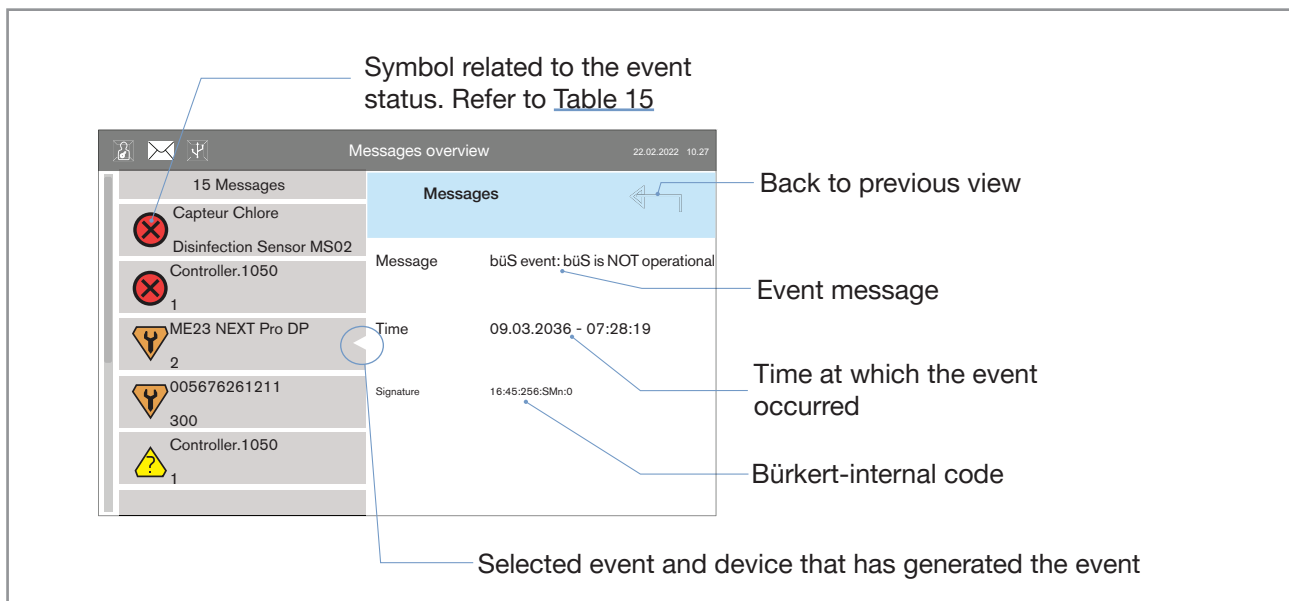

Fig. 19: Message overview

- To read the events that are related to the product, do the following procedure:
 - Go to device **pH sensor MS01** -----> function **General settings** -----> tab **Diagnostics**.
 - Select **Logbook**.

✓ The events that are related to the product are displayed. Refer to [Fig. 20](#).

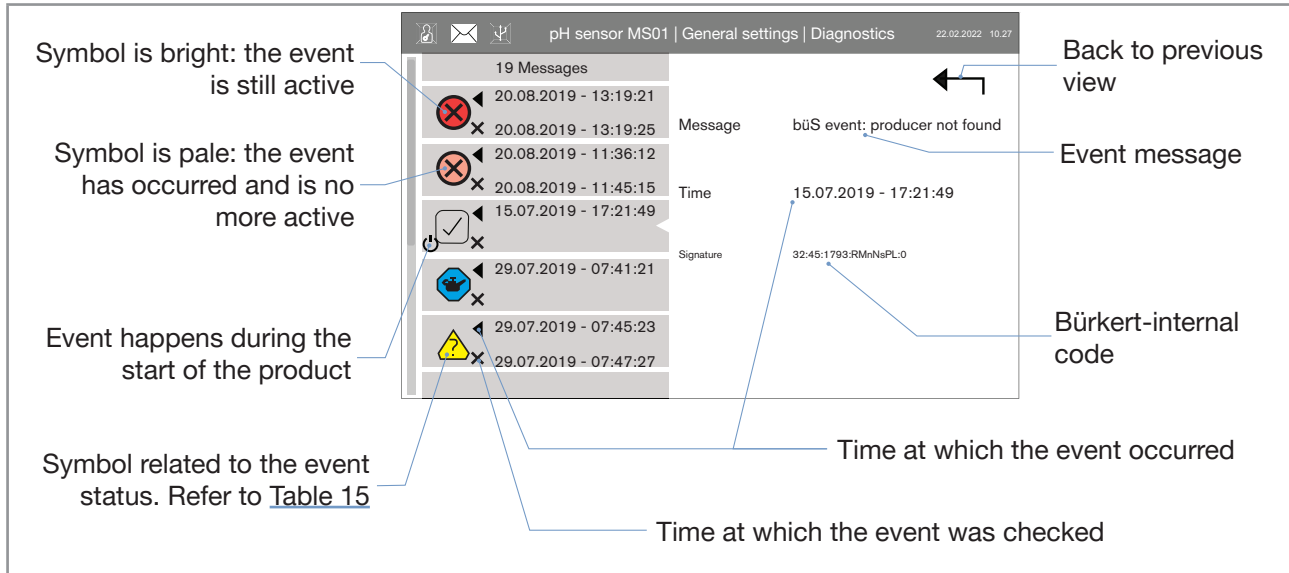

Fig. 20: Overview of events in the logbook

Table 15: Description of the symbols

| Symbol | Status | Description |
|--------|--|--|
| | Failure, error or fault | Malfunction |
| | Function check | Ongoing work on the product. For example, simulating measurement values |
| | Out of specification | At least one of the monitored parameters is outside its monitored limits. |
| | Maintenance required | The product is in controlled operation; however, the function is briefly restricted. → Do the required maintenance operation. |
| | Diagnostics active and no event has been generated | Status changes are shown in colour. Messages are listed and possibly transmitted through any connected fieldbus. |
| | Diagnostics inactive | Status changes are not shown. Messages are neither listed nor transmitted through any connected fieldbus. |

15 GENERAL SETTINGS - MAINTENANCE

- Go to device **pH sensor MS01** -----> function **General settings** -----> tab **Maintenance**.
- Select **Device information**. The menu shows only read-only values. [Table 16](#) shows the values.

Table 16: Description of the parameters

| Parameter | Description | |
|-------------------------------|---|--------------------------------------|
| Displayed name | Entered name of the product. The name of the product is shown on any display connected to the fieldbus. See chpt. 13.1. | |
| Ident. number | Product article-number | |
| Serial number | Product serial-number | |
| Software ident. number | Article number of the product software | |
| Software version | Version number of the product software | |
| büS version | büS version-number | |
| Hardware version | Version number of the product hardware | |
| Product type number | Type of the product | |
| Manufacture date | Product manufacturing-date | |
| eds version | EDS version-number | |
| Device driver | Driver version | Version number of the product driver |
| | Driver ident. number | Article number of the product driver |
| | Firmware group | Product name and EDS version-number |

15.1 Restart the product

- Make sure that the login user level is **Installer**. Refer to chpt. 9.4.
- Go to device **pH sensor MS01** -----> function **General settings** -----> tab **Maintenance**.
- Select **Reset device** -----> **Restart**.
- To cancel the procedure, select **Cancel**.
- To restart the product, select **Next**.

✔ The product restarts.

15.2 Reset the product to its factory settings

To reset the product to all its factory settings, do the following procedure:

- Make sure that the login user level is **Installer**. Refer to chpt. 9.4.
- Go to device **pH sensor MS01** -----> function **General settings** -----> tab **Maintenance**.
- Select **Reset device** -----> **Reset to factory settings**.
- To cancel the procedure, select **Cancel**.
- To reset the product to its factory settings, select **Next**.

✔ The product restarts and the product is reset to all its factory settings.

16 PROCESS DATA OBJECTS

The participants to bÜS or to a CANopen fieldbus use process data objects (PDOs) to communicate the cyclic data.

16.1 Transmitted PDOs

The PDOs that are transmitted by the product are described in [Table 17](#). The structure of the PDO4 is detailed in [chpt. 16.3](#).

Table 17: PDOs transmitted by the product

| Number | Name | Index | Data type | Unit SI | Range | Precision |
|--------|--|--------|-----------|---------|--------------|-----------|
| PDO1 | pH | 0x2500 | REAL32 | pH | pH -2...16 | 0,1 |
| | pH voltage | 0x2501 | REAL32 | V | -2,5...2,5 V | 1,0 E-4 |
| PDO2 | Impedance of the reference electrode | 0x2504 | REAL32 | Ω | 0...1 MΩ | 1000 |
| | Leakage current of the measuring-cell sensor (ISFET) | 0x2505 | REAL32 | A | - | 1.0 E-8 |
| PDO3 | Temperature of the water sample | 0x2502 | REAL32 | K | 233...398 K | 0,05 |
| PDO4 | pH State | 0x2503 | UNSIGNED8 | - | - | - |

16.2 Received PDOs

The PDOs that are received by the product are described in [Table 18](#).

Table 18: PDOs received by the product

| Number | Name | Index | Data type | Unit SI | Range |
|--------|------|--------|-----------|---------|-------|
| PDO1 | Hold | 0x2540 | UNSIGNED8 | - | - |







16.3 Structure of the PDO4 **pH State**

The PDO4 uses 1 byte. The PDO4 indicates whether the product is working correctly or not. Additionally, the PDO4 indicates the events that have been generated by the product.

Table 19: Bit distribution of the PDO4 - **pH State**

| Status bits | | | | | | | |
|-------------|---|---|---|---|---|---|---|
| 7 | 6 | 5 | 4 | 3 | 2 | 1 | 0 |

Table 20: Bit description of the PDO4 - pH State

| Bit | Description | Value | Symbol | Event messages |
|-----|---|---|---|-------------------------------------|
| 0 | Error event | 0 = no event | - | - |
| | | 1 = an error event is generated |  | Refer to chpt. 19.1 |
| 1 | Maintenance-required event | 0 = no event | - | - |
| | | 1 = a maintenance-required event is generated |  | Refer to chpt. 19.4 |
| 2 | Function-check event | 0 = no event | - | - |
| | | 1 = a function-check event is generated |  | Refer to chpt. 19.2 |
| 3 | Reserved | - | - | - |
| 4 | High error limits of the monitored values | 0 = limits not exceeded | - | - |
| | | 1 = one of the limits is exceeded |  | Refer to chpt. 19.3 |
| 5 | Low error limits of the monitored values | 0 = monitored values are above limits | - | - |
| | | 1 = at least one of the monitored values is below its limit |  | Refer to chpt. 19.3 |
| 6 | High warning limits of the monitored values | 0 = limits not exceeded | - | - |
| | | 1 = one of the limits is exceeded |  | Refer to chpt. 19.3 |
| 7 | Low warning limits of the monitored values | 0 = monitored values are above limits | - | - |
| | | 1 = at least one of the monitored values is below its limit |  | Refer to chpt. 19.3 |

17 MAINTENANCE

17.1 Safety instructions



WARNING

Risk of injury due to non-conforming maintenance.

- ▶ Maintenance must only be carried out by qualified and skilled staff with the appropriate tools.

NOTICE

Risk of damage to the product due to the power supply

- Shut down and isolate the electrical power source before carrying out work on the system.

17.2 When performing a maintenance operation

Do the maintenance operations in the following situations:

- Before starting up the product or the system after a maintenance operation. For example after replacement of the reference electrode or after replacement of the pH measuring cell, let the system operate for a time of 12 hours and calibrate the product if necessary.
- Calibrate the product every 3 months.

17.3 Remove the product from the backplane of the system

→ Make sure that you are working in a dry and clean place.

→ Before removing the last sensor cube from its backplane, stop the circulation of the fluid in the backplane to avoid liquid hammers in the system.

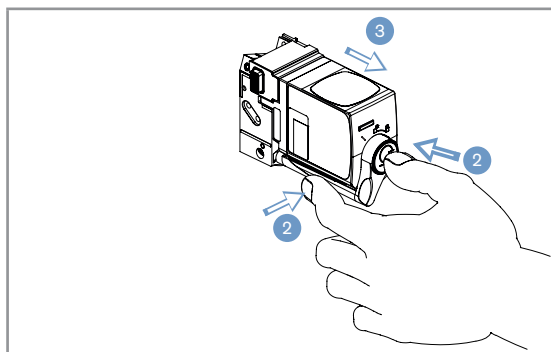

1. Prepare some absorbing paper.
2. Press the sensor-cube push-button and turn the bayonet lever to the right in the unlocked position ().
3. Pull the sensor cube and remove it from the backplane.
4. Place the sensor cube on absorbing paper.

Fig. 21: Removing the sensor cube from the backplane

17.4 Clean the product

CAUTION

Risk of injury due to the nature of the operating agents

- ▶ Respect the prevailing regulations on accident prevention and safety relating to the use of dangerous fluids.
- ▶ Observe the information on the safety data sheet. The safety data sheets can be found at:
 - Cleaning solution acid: <http://sds-id.com/200111-2>
 - Cleaning solution alkaline: <http://sds-id.com/200112-1>
 - Flushing solution (reagent): <http://sds-id.com/200116-7>
- ▶ Wear personal protective equipment when working with cleaning solutions.
- ▶ Dispose of waste containing chemicals produced by the system in an environmentally friendly manner.

Prerequisites:

- Buy a Type MZ15 handheld calibration-and-cleaning tool with article number 00568805.
- Buy a büS extension-cable. Refer to [Table 21](#). If needed, buy a Y junction.

Table 21: Accessories: cables and connectors

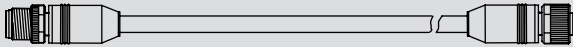
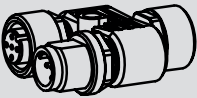
| Accessories | Article number |
|--|----------------|
| büS extension-cable with 5-pin M12 connectors, 0.5 m | 772403 |
| büS extension-cable with 5-pin M12 connectors, 1 m | 772404 |
| büS extension-cable with 5-pin M12 connectors, 3 m | 772405 |
| büS extension-cable with 5-pin M12 connectors, 5 m | 772406 |
|  | |
| Y junction | 772420 |
|  | |

- Buy a cleaning solution. Refer to [Table 22](#).

Table 22: Accessories: cleaning solution

| Accessories | Article number |
|-------------------------------------|----------------|
| Cleaning solution, acid, 250 ml | 807478 |
| Cleaning solution, alkaline, 250 ml | 807486 |

- Buy a flushing solution. Refer to [Table 23](#).

Table 23: Accessories: flushing solution

| Accessories | Article number |
|---------------------------|----------------|
| Flushing solution, 50 ml | 806709 |
| Flushing solution, 250 ml | 806710 |

→ Read the Type MZ15 Operating Instructions.

→ Observe the information on the safety data sheets for the used solutions. The relevant data sheet can be found at the address given on the bottom of the bottle.

1. Connect the Type MZ15 calibration-and-cleaning tool to the system using a büS extension-cable.
 2. Remove the product from the backplane of the system. Fit and lock the product to the backplane of the Type MZ15 handheld calibration-tool.
 3. Clean the fluidic parts of the product
- Wear personal protective equipment when working with cleaning solutions.

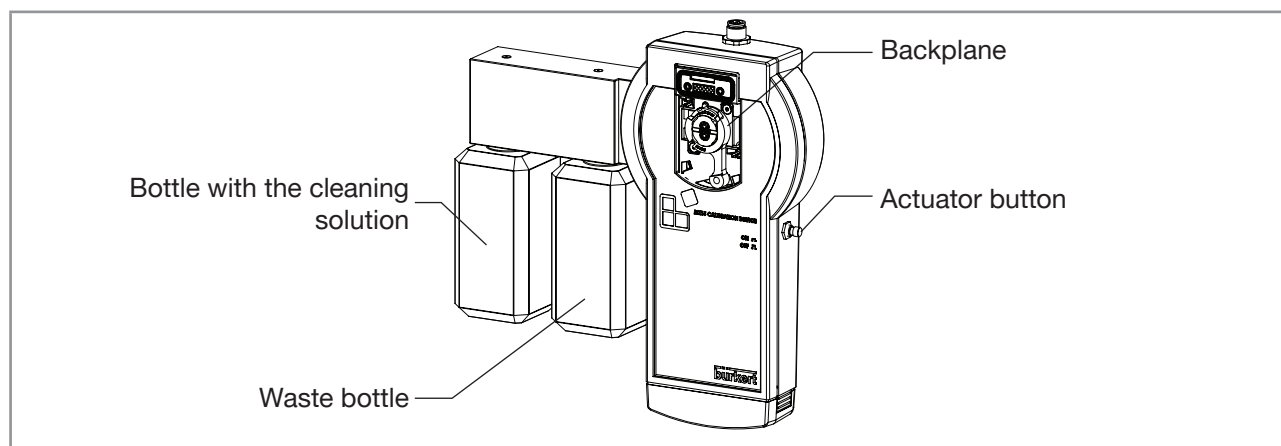

Fig. 22: Handheld calibration-and-cleaning tool: position of the bottle with the cleaning solution

→ Screw the bottle with the cleaning solution onto the bottle holder of the Type MZ15 as shown in Fig. 22

! → Keep the Type MZ15 handheld calibration-and-cleaning tool upright during cleaning procedure to make sure that both of the conditions are met:

- The cleaning solution flows correctly through the product.
- The check valves operate correctly.

→ Press the actuator button of the Type MZ15 in order to allow the cleaning solution to flow through the fluid system of the product. The pump will operate as long as the button is pressed. Adjust the pumping duration according to the degree of contamination of the product. Refer to Table 24.

Table 24: Recommended pumping durations according to degree of contamination

| Degree of contamination | Pumping duration (s) |
|-------------------------|----------------------|
| Light contamination | 10 |
| Average contamination | 20 |
| Heavy contamination | 60 |

→ Allow the cleaning solution to soak in for a time dependent on the degree of contamination. Refer to Table 25.

Table 25: Recommended soaking time depending on degree of contamination

| Degree of contamination | Soaking time (min) |
|-------------------------|--------------------|
| Light contamination | 5 |
| Average contamination | 10 |
| Heavy contamination | 15 |

→ Keep the Type MZ15 handheld calibration-and-cleaning tool upright during soaking time.

→ After the soaking time, unscrew the bottle with the cleaning solution.

→ Press the actuator button of the Type MZ15 in order to allow air to dry the fluid system of the product.

4. Flush the fluidic parts of the product

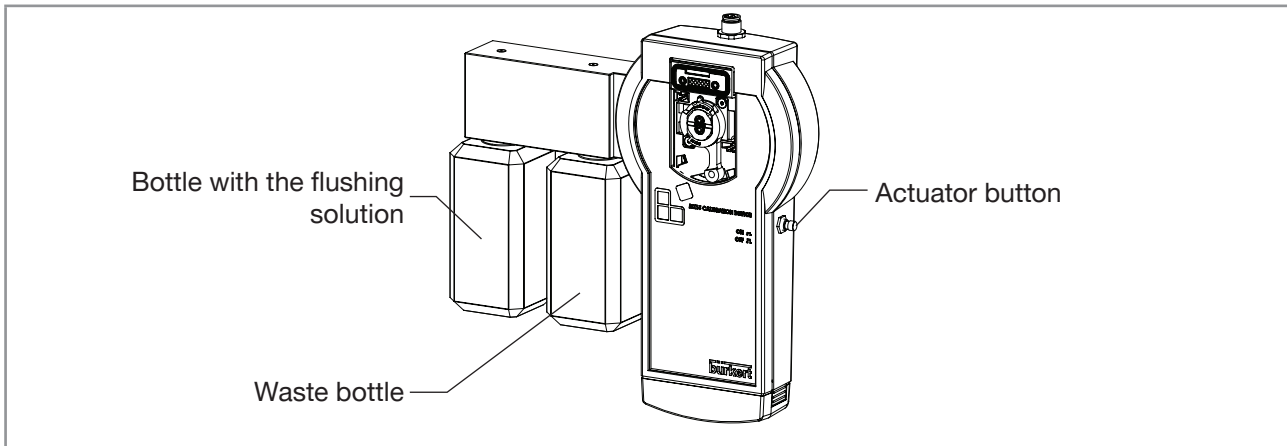

Fig. 23: Handheld calibration-and-cleaning tool: position of the bottle with the flushing solution

- Screw the bottle with the flushing solution as shown in Fig. 23.
- Keep the Type MZ15 upright during flushing.
- Press the actuator button of the Type MZ15 for 10, 20 or 30 s according to the degree of contamination. Refer to Table 26.

Table 26: Recommended flushing durations according to degree of contamination

| Degree of contamination | Flushing duration (s) |
|-------------------------|-----------------------|
| Light contamination | 10 |
| Average contamination | 20 |
| Heavy contamination | 30 |

- Unscrew the bottle with the flushing solution.
 - Press the actuator button of the Type MZ15 in order to allow air to dry the fluid system of the product.
5. Remove the product from the Type MZ15.
 6. Insert and lock the product back on the backplane of the system.
 7. Remove the büS extension-cable between the Type MZ15 and the system.

17.5 Replace the reference electrode of the product

The reference electrode must be replaced in the following cases:

- the error calibration limits for the offset value of the pH sensor are exceeded.
- the error limit of the reference-electrode impedance-value is exceeded.

Procedure to replace the reference electrode:

1. Remove the product from the backplane of the system.

→ While the push-button is pushed, turn the bayonet lever to the right, on the unlocked position, . Do not push the lever to the maintenance position.

→ Pull the product towards you and separate it from the backplane.

2. Remove the reference electrode from the product.

→ Lift the folding lever of the reference electrode and turn it by a quarter turn to the left.

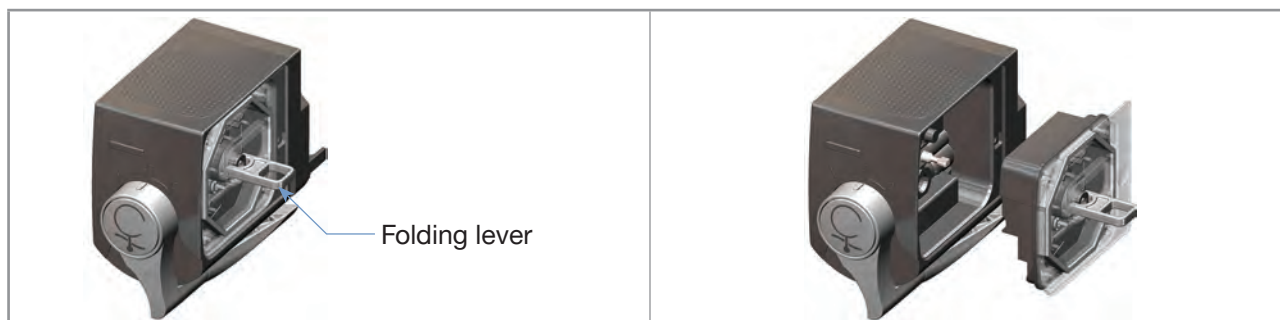

Fig. 24: Extraction of the reference electrode

→ Pull the folding lever to remove the reference electrode.

→ Dispose of the used reference electrode in an environmentally-friendly way.

→ If necessary, clean the empty seating of the reference electrode with a dry cloth or cotton swabs.

3. Prepare the new reference electrode.

→ Carefully remove the protective cover because it contains some storage solution.

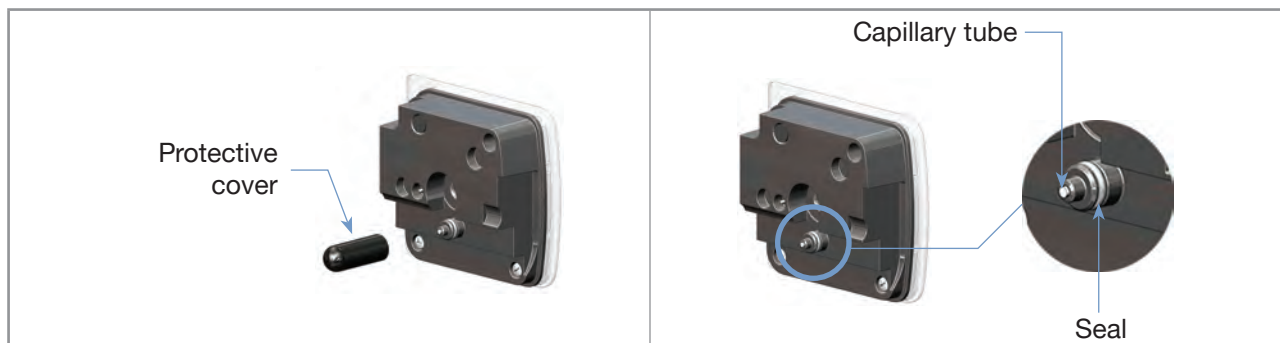

Fig. 25: Preparation of the new reference electrode

→ Make sure that the seal is in its groove on the reference electrode.

→ If necessary, remove the solid deposits from the capillary tube.

- Moisten the seal with water. If not, the seal can be damaged.
- Lift the folding lever of the reference electrode and turn it by a quarter turn to the left.
- 4. Insert the new reference electrode fully in the product.
- Turn the folding lever by a quarter turn to the right and lower it fully in its seating.

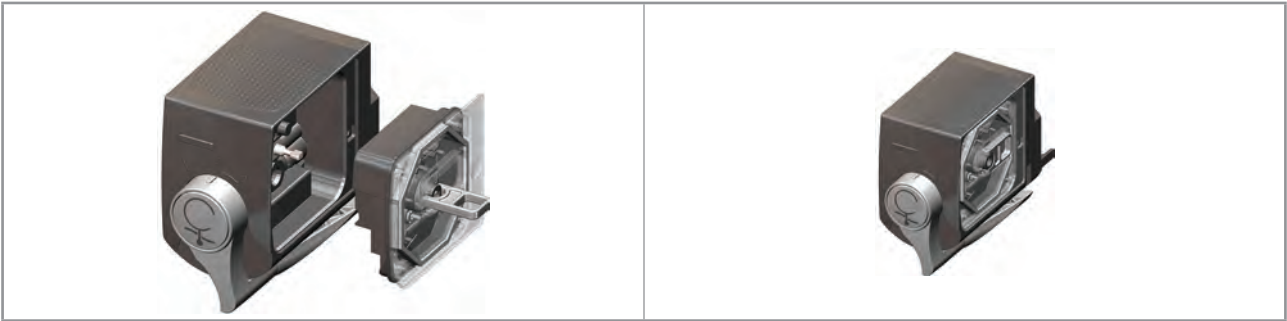

Fig. 26: Insertion of the new reference electrode in the product

- 5. Insert and lock the product back on the backplane of the system.
- 6. Let the fluid flow through the system for at least 12 hours. Observing this time makes sure that the product and the system operate properly and that the measurements are stable.

17.6 Replace the measuring cell of the product

The detailed procedure is described in the document "Service Instructions Type MS01 MS02 MS04". The Service Instructions is available at country.burkert.com.

17.7 Replace a defect product by a new one

You can only replace a product by a product with the same article number.

- Remove the defect product from the backplane.
- Remove the memory card from its slot.
- Pay attention to the insertion direction. Insert the memory card in the new product.
- Mount the new product to the backplane.
- Restart the new product to transfer the data from the memory card to the new product.

17.8 Transfer the product settings to another product

- Choose the product whose settings you want to transfer. If necessary, remove the product from the backplane.
- Remove the memory card from its slot.
- Pay attention to the insertion direction. Insert the memory card in the second product with the same article number.
- At the next product start-up, the second product adopts the product-specific data that is stored on the memory card.

18 TROUBLESHOOTING

The chapter describes the procedures to follow when troubles occur under the following conditions:

- Diagnostics are enabled. Refer to chpt. [13.11](#).
- No messages are generated.

If diagnostics are enabled and messages are generated, then refer to chpt. [19 Troubleshooting with messages](#).

18.1 Product-status indicator is off

If the product-status indicator is off, then the product or the system is not energized. To solve this issue, do the following:

- Check the wiring.
- Make sure that the voltage supply is 24 V DC.
- Check that the power supply source is working properly.

18.2 Measured pH values seem to be wrong or fluctuate

18.2.1 Measured pH values seem to be wrong

The product is working properly and the product-status indicator is green, but the measured pH values seem to be wrong.

- Check if the pH values are measured correctly or not. Use one of the following means:
 - Measure the water pH value with an external pH-meter.
 - If the pH values measured by the product have been recorded with the internal or an external data-acquisition system, then analyze the recorded values.
- If the pH values that are measured by the product are wrong, restart the product. If the color of the product-status indicator changes to red, go to chpt. [19.1](#). If the color of the product-status indicator remains green, follow the procedure below, until you find the cause of the problem:

1. Remove possible biofouling in the product:

- Clean the contact surfaces between the product and the reference electrode with a water-dampened cloth, including the capillary tube.
- Clean the fluidic channels of the reference electrode.
- Clean the fluidic parts of the product. Refer to chpt. [17.4](#).

2. Make sure that the flow rate in the product is at least 6 l/h.

3. To guarantee that the reference electrode is in contact with the water sample, make sure that the impedance value of the reference electrode is less than 160 k Ω . To read the impedance value, refer to chpt. [10.1](#).

If the impedance value is more than 160 kΩ, do the following procedure:

→ Make sure that the electrical spring contact of the reference electrode moves freely. Refer to [Fig. 27](#).

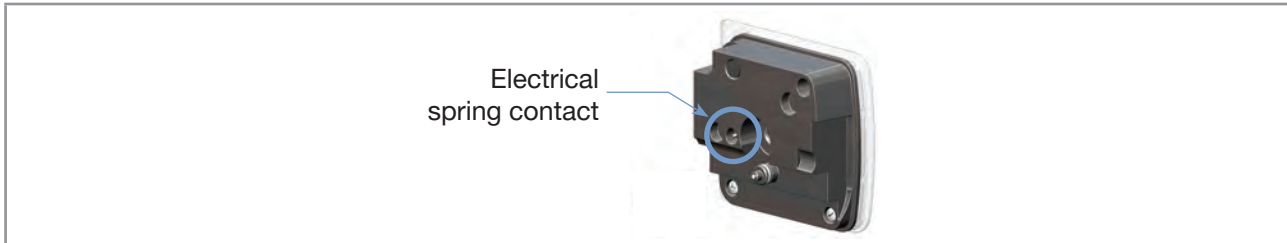

Fig. 27: Location of the electrical spring-contact on the reference electrode

→ Put the reference electrode back in place.

→ Read again the impedance value of the reference electrode. If the impedance value is still more than 160 kΩ, replace the measuring cell of the product by a new one. Refer to [chpt. 17.6](#).

→ Read again the impedance value of the reference electrode. If the impedance value is still more than 160 kΩ, send the product back to Bürkert.

4. Make sure that the measuring cell works properly.

→ Read the values of the parameters in [Table 27](#). Refer to [chpt. 11](#):

Table 27: Parameter range of the measuring cell

| Parameter | Description | Range |
|-----------------------|---|-------------------------|
| VDS | Value of the ISFET operating voltage | 480 mV < value < 520 mV |
| I drain | Value of the ISFET drain current | 80 μA < value < 120 μA |
| I source | Value of the ISFET source current | 80 μA < value < 120 μA |
| ISFET leakage current | Measured value of the ISFET leakage current | value < 100 nA |

If one of the values is outside the range, that is given in [Table 27](#), do the following procedure:

→ Replace the measuring cell of the product by a new one. Refer to [chpt. 17.6](#).

→ If the measured pH values are still wrong, send the product back to Bürkert.

5. Make sure that the temperature sensor works properly.

→ Measure the temperature of the water sample with an external instrument.

→ If the temperature measured with an external instrument is different from the temperature measured by the product, then calibrate the temperature sensor of the product. Refer to [chpt. 12.2](#).

→ If the measured temperature values are still wrong, send the product back to Bürkert.

6. Calibrate the pH sensor of the product. Refer to [chpt. 12.1](#).

18.2.2 Measured pH values fluctuate

The product is working properly and the product-status indicator is green, but the displayed pH values fluctuate. If the impedance values of the reference electrode fluctuates by +/-50 kΩ, then do the following procedure until you find the cause of the problem:

1. Check if there are bubbles in the product and remove the possible bubbles in the product.
 - Remove the reference electrode and put it back in place to remove the possible bubbles in the product.
 - If the measured pH values still fluctuate, install a bubble trap upstream the system to remove bubbles.
2. Remove possible pressure changes in the system.
 - Install a pressure regulator before the system.

18.3 Measured temperature values seem to be wrong

The product is working properly and the product-status indicator is green but the measured temperature values seem to be wrong.

- Measure the water-temperature value with an external instrument.
 - If the temperature values that are measured by the product are wrong, restart the product. If the color of the product-status indicator changes to red, go to chpt. [19](#). If the color of the product-status indicator remains green, follow the procedure below, until you find the cause of the problem:
1. Remove possible biofouling in the product:
 - Clean the contact surfaces between the product and the reference electrode with a water-dampened cloth, including the capillary tube.
 - Clean the fluidic channels of the reference electrode.
 - Clean the fluidic parts of the product. Refer to chpt. [17.4](#).
 2. Make sure that the flow rate in the product is at least 6 l/h.
 3. Make sure that the temperature sensor works properly:
 - Measure the temperature of the water sample with an external instrument.
 - If the temperature measured with an external instrument is different from the temperature measured by the product, then calibrate the temperature sensor of the product. Refer to chpt. [12.2](#).
 - If the measured temperature values are still wrong, send the product back to Bürkert.

19 TROUBLESHOOTING WITH MESSAGES

Messages can only be generated if the diagnostics are enabled. Refer to chpt. [13.11](#).

When a message is generated, the following actions are carried out:

- The symbol  is displayed in the information bar.
- The product-status indicator changes its colour and state based on the NAMUR NE 107 recommendation. Refer to chpt. [13.11](#).

→ To read the message, select . The message is displayed in the list **Messages overview**. See chpt. [14.10](#).

19.1 Messages : failure, error or malfunction

→ If the message displayed on your product is not explained in the Operating Instructions, contact Bürkert.

19.1.1 Message **Error 2 memory**

| | |
|--------------------------------|--|
| Product-status symbol |  |
| Bit status of the PDO pH-state | bit 0 = 1 |
| Possible cause | Possible unwanted water in the product. |
| What to do? | <p>→ Replace the measuring cell. Refer to chpt. 17.6.</p> <p>→ Calibrate the product. Refer to chpt. 12.1.</p> <p>→ If the message is still displayed, send the product back to Bürkert.</p> |

19.1.2 Message **DPB open IC109**

| | |
|--------------------------------|--|
| Product-status symbol |  |
| Bit status of the PDO pH-state | bit 0 = 1 |
| Possible cause | Possible unwanted water in the product. |
| What to do? | <p>→ Replace the measuring cell. Refer to chpt. 17.6.</p> <p>→ Calibrate the product. Refer to chpt. 12.1.</p> <p>→ If the message is still displayed, send the product back to Bürkert.</p> |

19.1.3 Message **büS event: producer not found**

| | |
|--------------------------------|--|
| Product-status symbol |  |
| Bit status of the PDO pH-state | bit 0 = 1 |
| Possible cause | When you want to automatically freeze the values, the device that can generate the binary event is not connected to büS. |
| What to do? | <p>→ Make sure that the device that generate the binary event is connected to büS.</p> <p>→ Make sure that the connection between the binary event and the product is set. Refer to chpt 10.7.2.</p> |

19.1.4 Message **büS is not operational**

| | |
|--------------------------------|---|
| Product-status symbol |  |
| Bit status of the PDO pH-state | bit 0 = 1 |
| Possible cause | Unknown cause |
| What to do? | <p>→ Restart the product.</p> <p>→ If the message is still displayed, send the product back to Bürkert.</p> |

19.2 Messages : function check

→ If the message displayed on your product is not explained in the Operating Instructions, contact Bürkert.

19.2.1 Message **Simulation mode active**

| | |
|--------------------------------|---|
| Product-status symbol |  |
| Bit status of the PDO pH-state | bit 2 = 1 |
| Possible cause | You are checking the correct behaviour of the system or of the product. Refer to chpt. 12.4 . |
| What to do? | <p>→ If you have finished to check the behaviour of the system or of the product, set the parameter Simulation -----> Status to Off. Refer to chpt. 12.5.</p> |

19.2.2 Message **Hold mode active**

| | |
|--------------------------------|---|
| Product-status symbol |  |
| Bit status of the PDO pH-state | bit 2 = 1 |
| Possible cause | The values that are sent by the product on the fieldbus are temporarily frozen. Refer to chpt. 10.7 . |
| What to do? | <p>→ Wait until the binary event is deactivated. Refer to chpt. 10.7.2.</p> <p>→ If you want that the measured values are sent on the fieldbus, set the parameter Hold -----> Mode to Off. Refer to chpt. 10.8.</p> |

19.3 Messages : out of specification

→ If the message displayed on your product is not explained in the Operating Instructions, contact Bürkert.

19.3.1 Message **Error: too low pH**

| | |
|--------------------------------|---|
| Product-status symbol |  |
| Bit status of the PDO pH-state | bit 5 = 1 |
| Possible cause | The pH value of the water sample is under the set limit. The message can only be displayed if the monitoring of the pH value has been configured and activated. Refer to chpt. 10.4. |
| What to do? | → Check the process. |

19.3.2 Message **Error: too high pH**

| | |
|--------------------------------|---|
| Product-status symbol |  |
| Bit status of the PDO pH-state | bit 4 = 1 |
| Possible cause | The pH value of the water sample is above the set limit. The message can only be displayed if the monitoring of the pH value has been configured and activated. Refer to chpt. 10.4. |
| What to do? | → Check the process. |

19.3.3 Message **Error: too low temperature**

| | |
|--------------------------------|---|
| Product-status symbol |  |
| Bit status of the PDO pH-state | bit 5 = 1 |
| Possible cause | The temperature value of the water sample is under the set limit. The message can only be displayed if the monitoring of the temperature value has been configured and activated. Refer to chpt. 10.5. |
| What to do? | → Check the process. |

19.3.4 Message **Error: too high temperature**

| | |
|--------------------------------|---|
| Product-status symbol |  |
| Bit status of the PDO pH-state | bit 4 = 1 |
| Possible cause | The temperature value of the water sample is above the set limit. The message can only be displayed if the monitoring of the temperature value has been configured and activated. Refer to chpt. 10.5. |
| What to do? | → Check the process. |

19.3.5 Message **Error: too low reference impedance**

| | |
|--------------------------------|---|
| Product-status symbol |  |
| Bit status of the PDO pH-state | bit 5 = 1 |
| Possible cause | <p>The impedance value of the reference electrode is under the set limit.</p> <p>The message can only be displayed if the monitoring of the impedance value has been configured and activated. Refer to chpt. 10.3.</p> |
| What to do? | <p>→ As the monitoring of the low limit is not important, make sure that the parameter Error triggers -----> Activation flags -----> Low ref. impedance is not selected.</p> |

19.3.6 Message **Error: too high reference impedance**

| | |
|--------------------------------|--|
| Product-status symbol |  |
| Bit status of the PDO pH-state | bit 4 = 1 |
| Possible cause | <p>The impedance value of the reference electrode is above the set limit.</p> <p>The message can only be displayed if the monitoring of the impedance value has been configured and activated. Refer to chpt. 10.3.</p> |
| What to do? | <p>→ Replace the reference electrode. Refer to chpt. 17.5.</p> <p>→ Check if the high warning limit is consistent. Refer to chpt. 10.1. If the high warning limit is not consistent, send the product back to Bürkert.</p> |

19.3.7 Message **Error: too low leakage current**

| | |
|--------------------------------|--|
| Product-status symbol |  |
| Bit status of the PDO pH-state | bit 5 = 1 |
| Possible cause | <p>The leakage current of the measuring cell is under the set limit.</p> <p>The message can only be displayed if the monitoring of the leakage current has been configured and activated. Refer to chpt. 10.6.</p> |
| What to do? | <p>→ As the monitoring of the low limit is not important, make sure that the parameter Error triggers -----> Activation flags -----> Low ISFET leak. current is not selected.</p> |

19.3.8 Message **Error: too high leakage current**

| | |
|--------------------------------|--|
| Product-status symbol |  |
| Bit status of the PDO pH-state | bit 4 = 1 |
| Possible cause | The leakage current of the measuring cell is above the set limit. The message can only be displayed if the monitoring of the leakage current has been configured and activated. Refer to chpt. 10.6 . |
| What to do? | → Replace the measuring cell. Refer to chpt. 17.6 . → Check if the high error limit is consistent. Refer to chpt. 10.6 . If the high error limit is not consistent, send the product back to Bürkert. |

19.3.9 Message **Warning: too low pH**

| | |
|--------------------------------|--|
| Product-status symbol |  |
| Bit status of the PDO pH-state | bit 7 = 1 |
| Possible cause | The pH value of the water sample is under the set limit. The message can only be displayed if the monitoring of the pH value has been configured and activated. Refer to chpt. 10.4 . |
| What to do? | → Check the process. |

19.3.10 Message **Warning: too high pH**

| | |
|--------------------------------|--|
| Product-status symbol |  |
| Bit status of the PDO pH-state | bit 6 = 1 |
| Possible cause | The pH value of the water sample is above the set limit. The message can only be displayed if the monitoring of the pH value has been configured and activated. Refer to chpt. 10.4 . |
| What to do? | → Check the process. |

19.3.11 Message **Warning: too low temperature**

| | |
|--------------------------------|--|
| Product-status symbol |  |
| Bit status of the PDO pH-state | bit 7 = 1 |
| Possible cause | The temperature value of the water sample is under the set limit. The message can only be displayed if the monitoring of the temperature value has been configured and activated. Refer to chpt. 10.5 . |
| What to do? | → Check the process. |

19.3.12 Message **Warning: too high temperature**

| | |
|--------------------------------|--|
| Product-status symbol |  |
| Bit status of the PDO pH-state | bit 6 = 1 |
| Possible cause | The temperature value of the water sample is above the set limit. The message can only be displayed if the monitoring of the temperature value has been configured and activated. Refer to chpt. 10.5 . |
| What to do? | → Check the process. |

19.3.13 Message **Warning: too low reference impedance**

| | |
|--------------------------------|---|
| Product-status symbol |  |
| Bit status of the PDO pH-state | bit 7 = 1 |
| Possible cause | The impedance value of the reference electrode is under the set limit. The message can only be displayed if the monitoring of the impedance value has been configured and activated. Refer to chpt. 10.3 . |
| What to do? | → As the monitoring of the low limit is not important, make sure that the parameter Warning triggers -----▶ Activation flags -----▶ Low ref. impedance is not selected. |

19.3.14 Message **Warning: too high reference impedance**

| | |
|--------------------------------|---|
| Product-status symbol |  |
| Bit status of the PDO pH-state | bit 6 = 1 |
| Possible cause | The impedance value of the reference electrode is above the set limit. The message can only be displayed if the monitoring of the impedance value has been configured and activated. Refer to chpt. 10.3 . |
| What to do? | → Acknowledge the warning message: the product continues to operate. → If necessary, replace the reference electrode. Refer to chpt. 17.5 . → Check if the high warning limit is consistent. Refer to chpt. 10.1 . If the high warning limit is not consistent, send the product back to Bürkert. |

19.3.15 Message **Warning: too low leakage current**

| | |
|--------------------------------|---|
| Product-status symbol |  |
| Bit status of the PDO pH-state | bit 7 = 1 |
| Possible cause | The leakage current of the measuring cell is under the set limit. The message can only be displayed if the monitoring of the leakage current has been configured and activated. Refer to chpt. 10.6. |
| What to do? | → As the monitoring of the low limit is not important, make sure that the parameter Error triggers -----> Activation flags -----> Low ISFET leak. current is not selected. |

19.3.16 Message **Warning: too high leakage current**

| | |
|--------------------------------|--|
| Product-status symbol |  |
| Bit status of the PDO pH-state | bit 6 = 1 |
| Possible cause | The leakage current of the measuring cell is above the set limit. The message can only be displayed if the monitoring of the leakage current has been configured and activated. Refer to chpt. 10.6. |
| What to do? | → Acknowledge the warning message: the product continues to operate. → If necessary, replace the measuring cell. Refer to chpt. 17.6. → Check if the high warning limit is consistent. Refer to chpt. 10.6. If the high warning limit is not consistent, send the product back to Bürkert. |

19.4 Messages : maintenance required

→ If the message displayed on your product is not explained in the Operating Instructions, contact Bürkert.

19.4.1 Message **Pair cell with sensor in maintenance menu**

| | |
|--------------------------------|---|
| Product-status symbol |  |
| Bit status of the PDO pH-state | bit 1 = 1 |
| Possible cause | <ul style="list-style-type: none"> The measuring cell has been replaced. |
| What to do? | <p>→ Pair the new measuring cell with the product. The detailed procedure is described in the document "Service Instructions Type MS01 MS02 MS04". The Service Instructions is available at country.burkert.com.</p> |

19.4.2 Message **Calibration date has expired**

| | |
|--------------------------------|---|
| Product-status symbol |  |
| Bit status of the PDO pH-state | bit 1 = 1 |
| Possible cause | <ul style="list-style-type: none"> The calibration date is due. |
| What to do? | <p>→ Calibrate the product. Refer to chpt. 12.1.</p> |

19.5 Messages : informations

→ If the message displayed on your product is not explained in the Operating Instructions, contact Bürkert.

19.5.1 Message **Transferable memory is not accessible**

| | |
|--------------------------------|--|
| Product-status symbol |  |
| Bit status of the PDO pH-state | - |
| Possible cause | <ul style="list-style-type: none"> No memory card is plugged in the product. |
| What to do? | <p>→ If a memory card is needed, insert a memory card. Contact your Bürkert sales office to buy a new memory card.</p> <p>→ If no memory card is needed, valid the message by clicking on Acknowledge.</p> |

20 SPARE PARTS AND ACCESSORIES

CAUTION

Risk of injury or damage caused by the use of unsuitable parts

Incorrect accessories and unsuitable replacement parts may cause injuries and damage the product and the surrounding area.

- ▶ Use only original accessories and original replacement parts from Bürkert.

Table 28: Spare parts

| Spare parts | Article number |
|---|----------------|
| Reference electrode | 566084 |
| Set that includes the following items: | 568038 |
| <ul style="list-style-type: none"> • 1 pH measuring cell • 1 black seal • 1 rubber elastomer | |
| Memory card | On request |

Table 29: Accessories: cables and connectors



| Accessories | Article number |
|--|----------------|
| büS extension-cable with 5-pin M12 connectors, 0.5 m | 772403 |
| büS extension-cable with 5-pin M12 connectors, 1 m | 772404 |
| büS extension-cable with 5-pin M12 connectors, 3 m | 772405 |
| büS extension-cable with 5-pin M12 connectors, 5 m | 772406 |
|  | |
| Y junction | 772420 |
|  | |
| USB-büS interface set | 772426 |
|  | |

Table 30: Accessories: calibration-and-cleaning tool

| Accessories | Article number |
|--|----------------|
| Type MZ15 handheld calibration-and-cleaning tool | 568805 |

Table 31: Accessories: cleaning solution

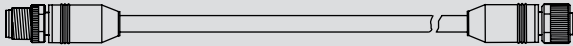
| Accessories | Article number |
|-------------------------------------|----------------|
| Cleaning solution, acid, 250 ml | 807478 |
| Cleaning solution, alkaline, 250 ml | 807486 |

Table 32: Accessories: buffer solution

| Accessories | Article number |
|--|----------------|
| Buffer solution pH 5.00 (20 °C), 50 ml | 806698 |
| Buffer solution pH 7.00 (20 °C), 50 ml | 806699 |
| Buffer solution pH 9.00 (20 °C), 50 ml | 806700 |

Table 33: Accessories: flushing solution

| Accessories | Article number |
|---------------------------|----------------|
| Flushing solution, 50 ml | 806709 |
| Flushing solution, 250 ml | 806710 |

Table 34: Accessories: storage solution

| Accessories | Article number |
|---------------------------------------|----------------|
| Storage solution pH electrode, 500 ml | 418557 |

21 PACKAGING, TRANSPORT

Before any packaging or transport of the product, do the following procedure:

1. Flush the product with tap water.
2. Purge the product with air at a max. pressure of 2 bar.

NOTICE

Damage due to transport

Transport may damage an insufficiently protected product.

- Protect the electrical interfaces with protective covers.
- Transport the product in an impact-resistant package, protected from moisture and dirt.
- Avoid storage above or below the recommended storage temperature.

22 STORAGE

NOTICE

Poor storage can damage the product.

- ▶ Depending on the duration of the storage time, respect the storage instructions in the chpt. [22.1](#) or [22.2](#).
- ▶ After any storage period, obey the instructions in chpt. [22.3](#).

22.1 To store the product for a maximum of 10 days

1. Flush the product with tap water.
2. Purge the product with air at a max. pressure of 2 bar.
3. Protect the electrical interfaces with protective covers.
4. Store the product with following recommendations:
 - in an antistatic packaging or product plugged in the backplane, system not energize and no water flows through the system.
 - at room temperature (about 20 °C ±5 °C).
 - in a dry place, away from dust.

22.2 To store the product for more than 10 days

1. Flush the product with tap water.
2. Purge the product with air at a max. pressure of 2 bar.
3. Remove the reference electrode. To protect the capillary tube, put a few drops of a 3-mol-KCl solution or another storage solution in the protective cover. Bürkert recommends to use the storage solution with reference article 418557. Place the protective cover on the capillary tube. Refer to chpt. [17.5](#).
4. Protect the electrical interfaces with protective covers.
5. Store the product with following recommendations:
 - in an antistatic packaging.
 - at room temperature (about 20 °C ±5 °C).
 - in a dry place, away from dust.

22.3 After storage

Before commissioning a product that has been stored:

1. Mount the reference electrode. Refer to chpt. [17.5](#).
2. Insert and lock the product on the backplane of the system.
3. While the power supply of the system is OFF, let the water sample flow through the product for at least 12 hours.
4. If necessary, calibrate the product. Refer to chpt. [12.1.2](#) and [12.1.3](#).

23 DISPOSAL OF THE PRODUCT

→ Dispose of the product and its packaging in an environmentally-friendly way.

NOTICE

Damage to the environment caused by products contaminated by fluids.

- ▶ Comply with the national and/or local regulations which concern the area of waste disposal.

