

# Type ME66 bÜS distribution box

Passive distributor

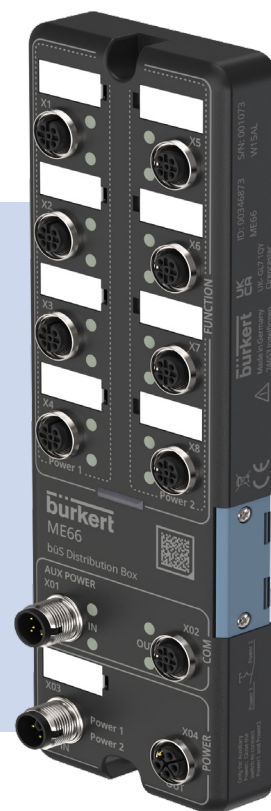

Operating instructions

We reserve the right to make technical changes without notice.  
Technische Änderungen vorbehalten.  
Sous réserve de modifications techniques.

© Bürkert Werke GmbH & Co. KG, 2023

Operating Instructions 2302/00\_EUen\_00815432/ Original DE

## CONTENT

<b>1</b>	<b>THE OPERATING INSTRUCTIONS .....</b>	<b>5</b>
1.1	Symbols.....	5
1.2	Definition of terms.....	5
<b>2</b>	<b>INTENDED USE .....</b>	<b>6</b>
<b>3</b>	<b>BASIC SAFETY INSTRUCTIONS .....</b>	<b>7</b>
<b>4</b>	<b>GENERAL NOTES.....</b>	<b>8</b>
4.1	Contact addresses.....	8
4.2	Warranty .....	8
4.3	Information on the Internet.....	8
<b>5</b>	<b>PRODUCT DESCRIPTION.....</b>	<b>9</b>
<b>6</b>	<b>TECHNICAL DATA .....</b>	<b>10</b>
6.1	Standards and directives.....	10
6.2	Operating conditions .....	10
6.3	Electrical data .....	10
6.4	Device labelling.....	11
6.4.1	Device top side labelling.....	11
6.4.2	Left and right device side labelling .....	12
<b>7</b>	<b>INSTALLATION.....</b>	<b>13</b>
7.1	Installing the device .....	13
7.2	Opening and/or closing the side panel.....	13
7.3	Electrically connecting the device .....	14
7.3.1	Assigning the connections .....	14
7.4	Combining ME6x modules .....	15
7.4.1	Module connections for the power supply.....	15
7.4.2	Simplified power supply plan .....	17
7.4.3	Combining ME66 modules .....	19
7.5	Combining different ME modules.....	20

8	DISPLAY ELEMENTS .....	21
8.1	LED for displaying device status.....	21
9	TRANSPORTATION, STORAGE, DISPOSAL.....	22

# 1 THE OPERATING INSTRUCTIONS

The operating instructions describe the entire life cycle of the device. Keep these instructions ready to hand at the operating site.

## Important safety information!

- ▶ Read these instructions carefully.
- ▶ Above all, observe the safety instructions, intended use and operating conditions.
- ▶ Persons who work on the device must read and understand these instructions.

## 1.1 Symbols



### WARNING

Warns of a potentially hazardous situation.

- ▶ Failure to observe these instructions may result in serious injuries or death.



### CAUTION

Warns of a potential danger.

- ▶ Failure to observe may result in moderate or minor injuries.

### NOTE

Warns of damage to property.

- ▶ Failure to observe these instructions may result in damage to the device or the system.



Indicates important additional information, tips and recommendations.



Refers to information in these operating instructions or in other documentation.

- ▶ Highlights instructions to avoid a danger.
- Highlights a procedure which you must carry out.

## 1.2 Definition of terms

Term	Description
Device	büS distribution box Type ME66
büS	Bürkert system bus; a communication bus developed by Bürkert, based on the CANopen protocol.

## 2 INTENDED USE

The bÜS distribution box Type ME66 is a passive distributor and is available as an accessory for cabling bÜS networks, for the fieldbus gateway Type ME63.

- ▶ Use the device only as intended. Non-intended use of the device may be dangerous to people, nearby equipment and the environment.
- ▶ Use the device only in conjunction with third-party devices and components recommended or approved by Bürkert.
- ▶ Only operate the device when it is in perfect condition.
- ▶ Prerequisites for safe and trouble-free operation are correct transportation, correct storage, installation, start-up, operation and maintenance.
- ▶ To use the device, observe the permitted data, operating conditions and conditions of use. These specifications can be found in the contract documents, the operating instructions and on the device.

### 3 BASIC SAFETY INSTRUCTIONS

These safety instructions do not take into account any unforeseen circumstances and events which occur during installation, operation and maintenance. The operator is responsible for observing the location-specific safety regulations, also with reference to personnel.



#### General hazardous situations.

To prevent injuries, observe the following:

- ▶ Use the device only when it is in a perfect state and in accordance with the operating instructions.
- ▶ Do not make any changes to the device and do not subject it to mechanical stress.
- ▶ Secure device or system to prevent unintentional activation.
- ▶ Make sure only trained technicians carry out installation and maintenance work.
- ▶ Install the device according to the regulations applicable in the respective country.
- ▶ After an interruption in the power supply, ensure that the process is restarted in a controlled manner.
- ▶ Observe the general rules of technology.

#### ATTENTION

##### Notes for UL certified devices:

- ▶ Device is only suitable for operation at SELV/PELV voltages (Class III).
- ▶ Device is suitable for indoor areas (dry areas) and not for wet areas.
- ▶ Observe the national and international guidelines for setting up electrical systems.
- ▶ External circuits connected to the connections must be galvanically isolated from the network, with the aid of double or reinforced isolation (SELV/PELV).
- ▶ Make sure that overcurrent protection is available during final installation.
- ▶ Device belongs to Overvoltage Category II, Degree of Contamination 2.

#### ATTENTION

##### Electrostatically sensitive components and assemblies.

The device contains electronic components that are susceptible to the effects of electrostatic discharging (ESD). Components that come into contact with electrostatically charged persons or objects are at risk. In the worst case scenario, these components will be destroyed immediately or fail after start-up.

- ▶ Meet the requirements specified by EN 61340-5-1 to minimise or avoid the possibility of damage caused by a sudden electrostatic discharge.
- ▶ Do not touch electronic components when the supply voltage is connected.

## 4 GENERAL NOTES

### 4.1 Contact addresses

#### Germany

Bürkert Fluid Control Systems  
Sales Centre  
Christian-Bürkert-Str. 13–17  
D-74653 Ingelfingen  
Tel.: + 49 (0) 7940 - 10-91 111  
Fax: + 49 (0) 7940 - 10-91 448  
E-mail: [info@burkert.com](mailto:info@burkert.com)

#### International

You can find the international contact addresses on the Internet at: [country.www.burkert.com](http://country.www.burkert.com)

### 4.2 Warranty

A precondition for the warranty is that the device is used as intended in consideration of the specified operating conditions.

### 4.3 Information on the Internet

Operating instructions and data sheets for the Bürkert products can be found on the Internet at:  
[country.burkert.com](http://country.burkert.com)



## 5 PRODUCT DESCRIPTION

The passive distributor Type ME66 is an extension module for Bürkert products in the ME6x series and acts as a bUS/CAN open distributor (X1-X8).

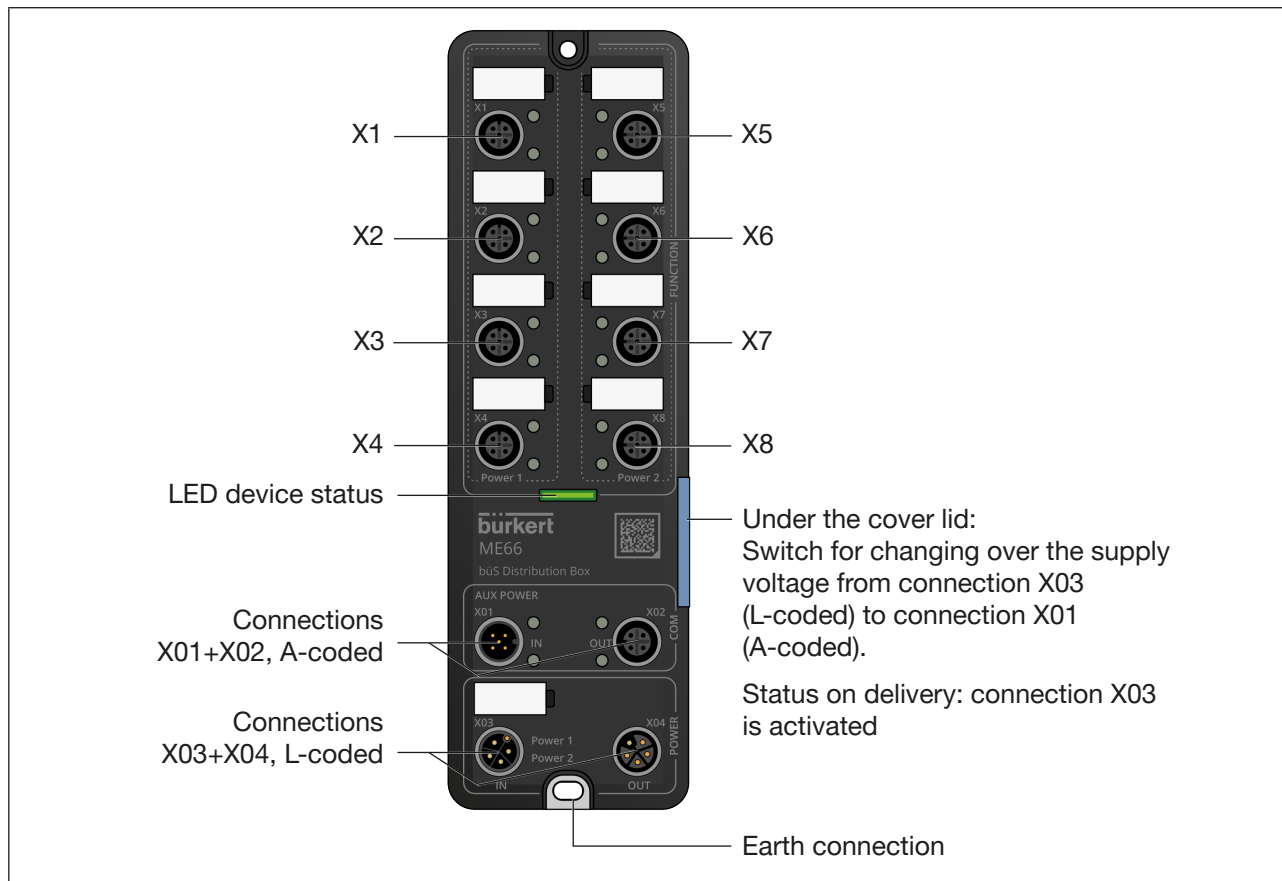

Image 1: View of passive distributor Type ME66

## 6 TECHNICAL DATA

### 6.1 Standards and directives

The device complies with the valid EU harmonisation legislation. In addition, the device also complies with the requirements of the laws of the United Kingdom.

The harmonised standards that have been applied for the conformity assessment procedure are listed in the current version of the EU Declaration of Conformity/ UK Declaration of Conformity.

### 6.2 Operating conditions

#### NOTE

**Malfunction due to heat and heavy frost.**

- ▶ Do not use the device outside the specified ambient temperature.

Ambient temperature	-20 °C...+60 °C
Storage temperature	-30 °C...+80 °C
Altitude	max. 2000 m
Material	Polycarbonate

### 6.3 Electrical data

#### NOTE

- ▶ If the electrical supply is implemented via the L-coded connections, observe the maximum power load of the A-coded connections of 4 A.

Supply voltage	24 V $\overline{=}$ +20 %/ -15 %
Power consumption of the module	0.73 W
Max. input current	4 A for input via X01 (M12, A-coded, plug) 32 A for input via X03 (M12, L-coded, plug)
Max. output current	4 A via büS-/CANopen connection (X1-X4, X5-X8) for input via X03, 4 A total for input via X01
Degree of protection	IP65, IP67 and IP69k according to EN 60529 / IEC 60529 (for connected cables and while using protective caps for unused connections)
UL devices	SELV/ PELV with UL Recognized Overcurrent Protection, design according to UL/IEC 61010-1 Table 18
Protection class	3 according to DIN EN 61140 (VDE 0140)

## 6.4 Device labelling

### 6.4.1 Device top side labelling

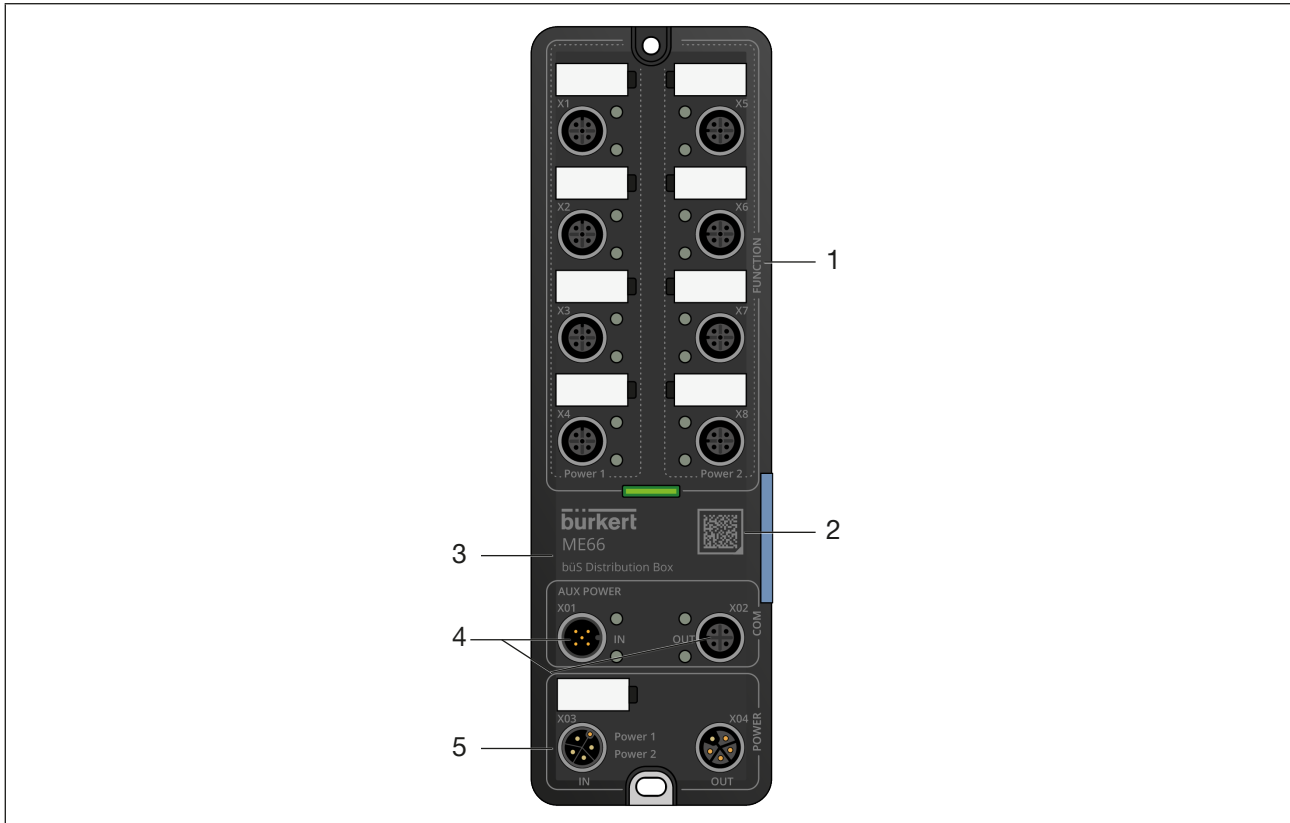

Image 2: Device top side labelling

Item	Designation
1	Device-specific function
2	Data matrix code with link to Bürkert product page
3	Type & device designation
4	IN (X01): AUX power for alternative supply via A-coded M12 plug
	OUT (X02): AUX power for integration of more bus/CANopen devices via A-coded M12 socket
5	Power supply

### 6.4.2 Left and right device side labelling

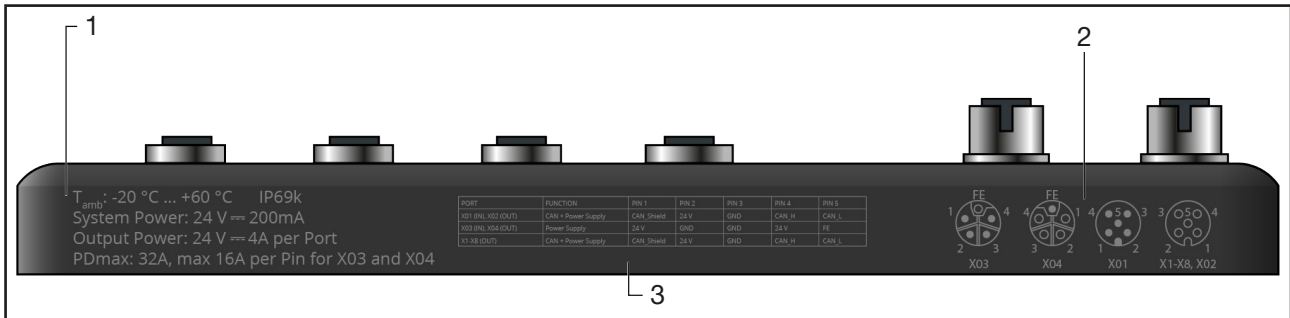

Image 3: Labelling on the left side of the device

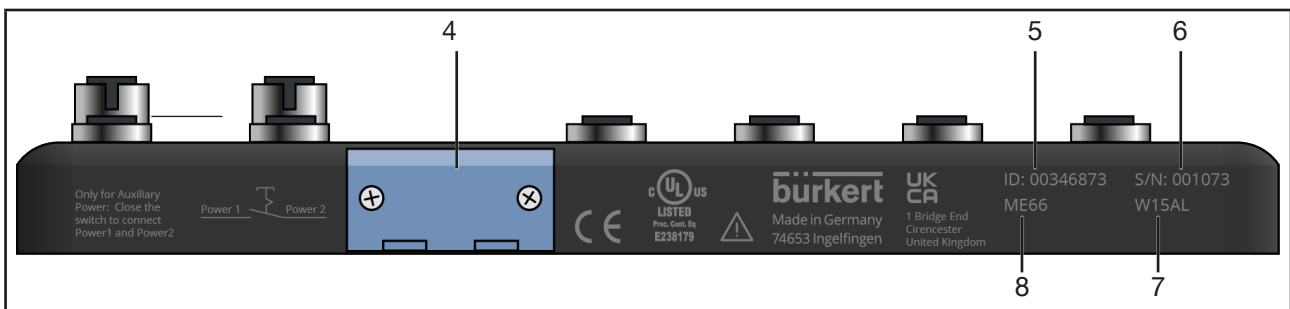

Image 4: Labelling on the right side of the device

Item	Designation
1	Performance data (ambient temperature, IP degree of protection for voltage, power consumption)
2	Push-in connector icons
3	Pin assignment
4	AUX power switch (located under the blue cover)
5	Order number
6	Serial number
7	Manufacture code (encrypted)
8	Type

## 7 INSTALLATION



### WARNING

Risk of injury due to improper installation.

- ▶ Only trained technicians may perform installation work.
- ▶ Perform installation work using suitable tools only.

### 7.1 Installing the device



The device will be delivered fully installed. Modifications to the device are only permitted to be carried out by Bürkert.

→ Install the device on a level surface using 2 screws (M4) and 2 flat washers (according to DIN 125). Observe the maximum tightening torque of 1Nm.

→ Earth the device via the earthing lead. The earthing lead is located at the lower device attachment.



To discharge interference currents and EMC resistance, the devices have an earth connection.



### CAUTION

**Malfunction due to electrostatic discharge.**

Electrostatic discharge on the device may cause malfunctions.

- ▶ Connect the device to the functional earth.

**Danger due to electro-magnetic fields.**

If the functional earth (FE) is not connected, this represents an infringement of the legal regulations of EMC.

- ▶ Connect the device to the functional earth.
- ▶ If the installation surface is not grounded, use an earthing strap or FE line. Connect the earthing strap or FE line to the earthing point using an M4 screw.

### 7.2 Opening and/or closing the side panel

→ To open or close the side panel, unfasten or fasten both screws using a cross-tip screwdriver.

#### NOTE

Guarantee the degree of protection when screwing on the cover.

- ▶ Ensure that the seal is correctly fitted.
- ▶ When screwing on the cover, observe a maximum tightening torque of 0.4 Nm.

## 7.3 Electrically connecting the device



### Requirements for UL-certified devices:

- ▶ Only connect devices with a UL-certified cable (CYJV or PVVA) with suitable nominal values.
- ▶ Maximum permitted cable temperature is 105° C.
- ▶ Do not lay Ethernet cables used for communication outside buildings.
- ▶ Galvanically isolate external circuits connected to ports from mains circuits, in order to protect them against isolation breakdown in the communication network.

### ATTENTION

#### Prerequisite for the fault-free functioning of the device and to avoid interference issues:

- ▶ Use only shielded cables with a braided or foil shield.

#### Ensure the degree of protection.

- ▶ Fit unused connections with protective caps.

### 7.3.1 Assigning the connections

#### NOTE

#### Ensure the degree of protection.

- ▶ Fit unused connections with protective caps.

#### Connections X03 (IN), X04 (OUT)

Function: supply voltage 24 V

	Pin	Assignment	Function
	1	24 V (Power 1)	Power supply
	2	GND (Power 1)	Power supply
	3	GND (Power 2)	Power supply
	4	24 V (Power 2)	Power supply
	5	FE	Shielding

Table 1: Passive distributor, connections M12, X03 (plug), X04 (socket), L-coded

#### Connections X1-X8 and X01 (IN) + X02 (OUT)

	Pin	Assignment	Function
	1	FE / CAN_GND	Shielding
	2	24 V	Power supply
	3	GND	Power supply
	4	CAN_H	büS communication
	5	CAN_L	büS communication

Table 2: Passive distributor, connections M12, X01 (plug) and X1-X8 and X02 (socket), A-coded

## 7.4 Combining ME6x modules

### 7.4.1 Module connections for the power supply



Image 5: Power supply via bus connection

ME63		ME64 & ME66	
X1-X3; X5-X8	M12-A, socket, bus/CANopen and 24 V DC, max. 4 A, for connection of a device via bus/CANopen	X01	M12-A, plug, bus/CANopen IN, max. 4 A, for connection of bus/ CANopen network
X4	M12-A, plug, bus/CANopen and 24 V DC, max. 4 A, preferably for bus/CANopen connection	X02	M12-A, socket, bus/CANopen OUT, max. 4 A, for the integration of other bus/ CANopen devices

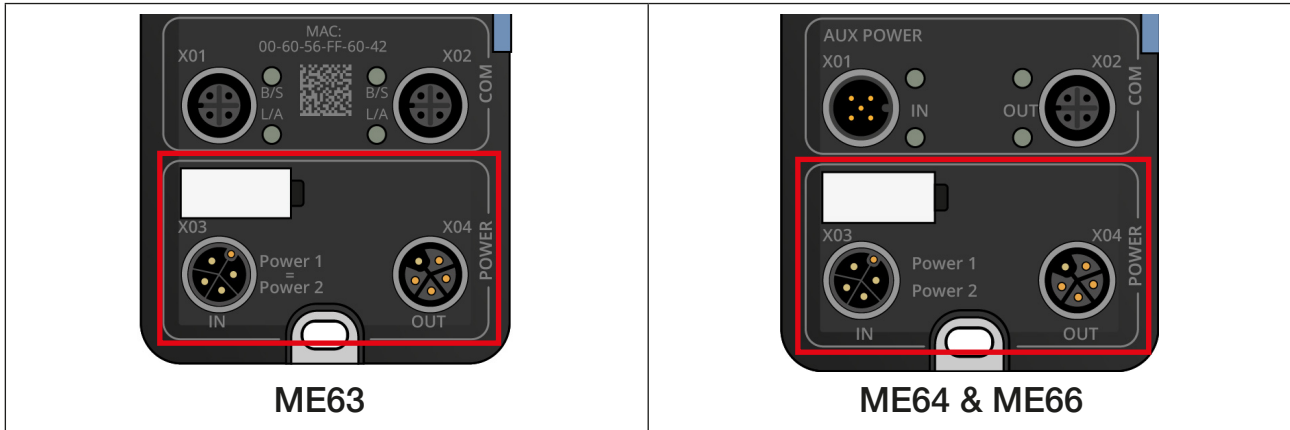

Image 6: Power supply via X03

Connection	Description
X03 (IN)	M12-L, plug, power IN, max. 32 A, for power supply input
X04 (OUT)	M12-L, socket, power OUT, max. 32 A, for power supply for other devices

### ATTENTION

#### Damage to device

- The L-coded M12 connection (X03, X04) is designed for connecting 2 power supplies, each up to max. 16 A. Do not exceed these values.



### 7.4.2 Simplified power supply plan

When modules in the ME6x product series are combined, the information provided in this chapter must be followed.



For type ME63, the supply can be either via X03 (max. 2x16A) or X4 (max. 4A).

- **Attention:** A supply via both is prohibited.



For Type ME64, Power 1 and Power 2 are two separate circuits with common ground.

- Both supplies are routed separately to the module. Power 1 supplies ports X1-X8 (and the internal electronics assembly of the module).
- The switch must be closed if the supply comes via AUX power.
- **Attention:** Only max. 4A will then be available for the entire module. It must be guaranteed that the module is not supplied via X03 if the supply comes via AUX power.



For Type ME66, Power 1 and Power 2 are two separate circuits with common ground.

- Power 1 supplies ports X1-X4, Power 2 supplies ports X5-X8
- Power supply via port X03 with a current of 2 x 16A (16A per circuit).
- Switch may only or must be closed when supplied via X01 (AUX). With supply via X03, do NOT close the switch!

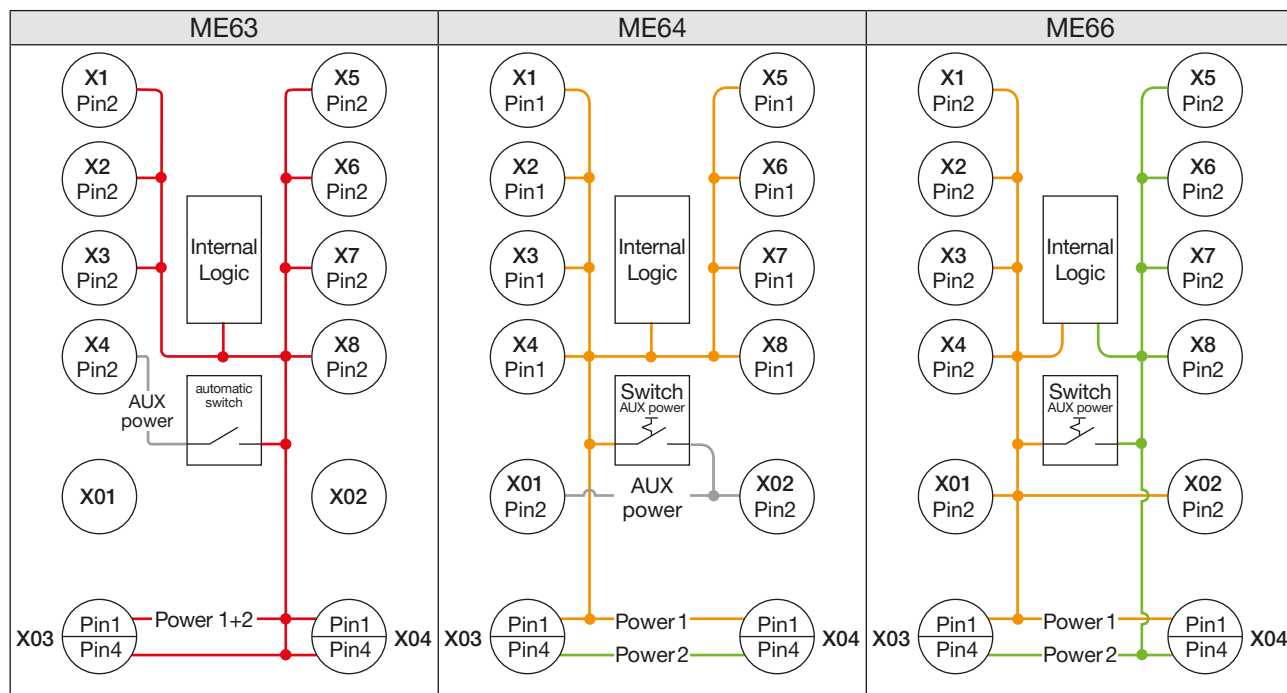

Image 7: Simplified circuit diagram

Colour	Description
	Power 1
	Power 2
	Power 1 = Power 2 (both circuits are connected)

Table 3: Simplified circuit diagram key

### Reverse protection - ME63

If both supplies (A-coded and L-coded) are connected, it is not permitted for any return flow to occur via the A-coded supply. With the ME63 type, this is prevented via reverse protection.

If the modules are only supplied via the M12 A-coded (X4) supply, the reserve protection function switches over automatically.

### Power supply via X01 (AUX power) - ME64 & ME66

The power supply is activated via port X03 for the modules in delivery condition.

#### **ATTENTION**

**Input cannot be made via both ports at the same time.**

If the modules are supplied via port X01, the switch must be changed over.

Underneath the light blue side panel, there is a switch for changing over the module supply from X03 to port X01 (AUX power). „[7.4.2 Simplified power supply plan](#)“

#### **ATTENTION**

**Damage to the switch for AUX power.**

A current >4A will damage the switch.

- ▶ When switching over to AUX power, make sure that the maximum current is no greater than 4 A, otherwise the switch will be damaged.

### 7.4.3 Combining ME66 modules

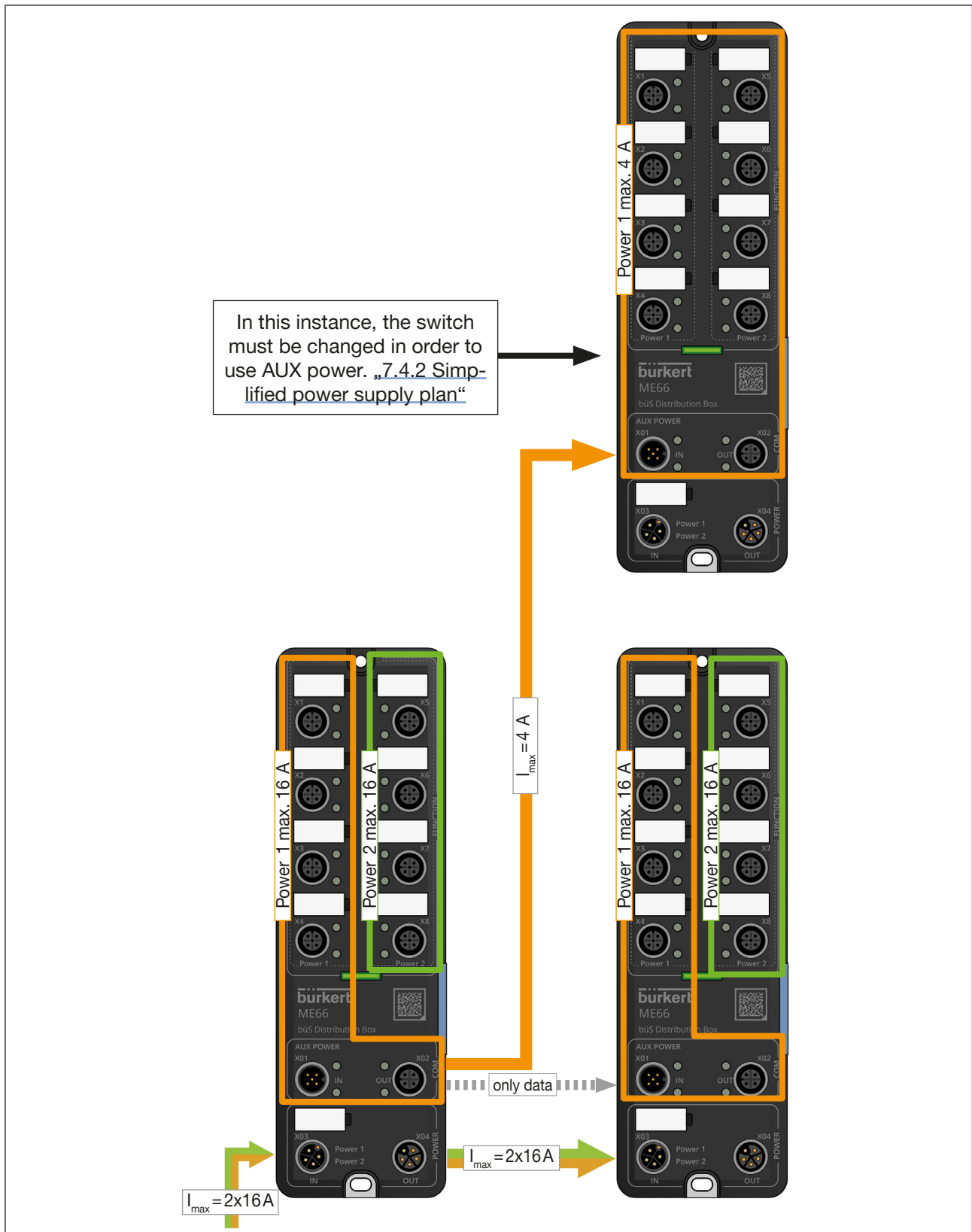

Image 8: Example for the combination of ME66 modules

## 7.5 Combining different ME modules

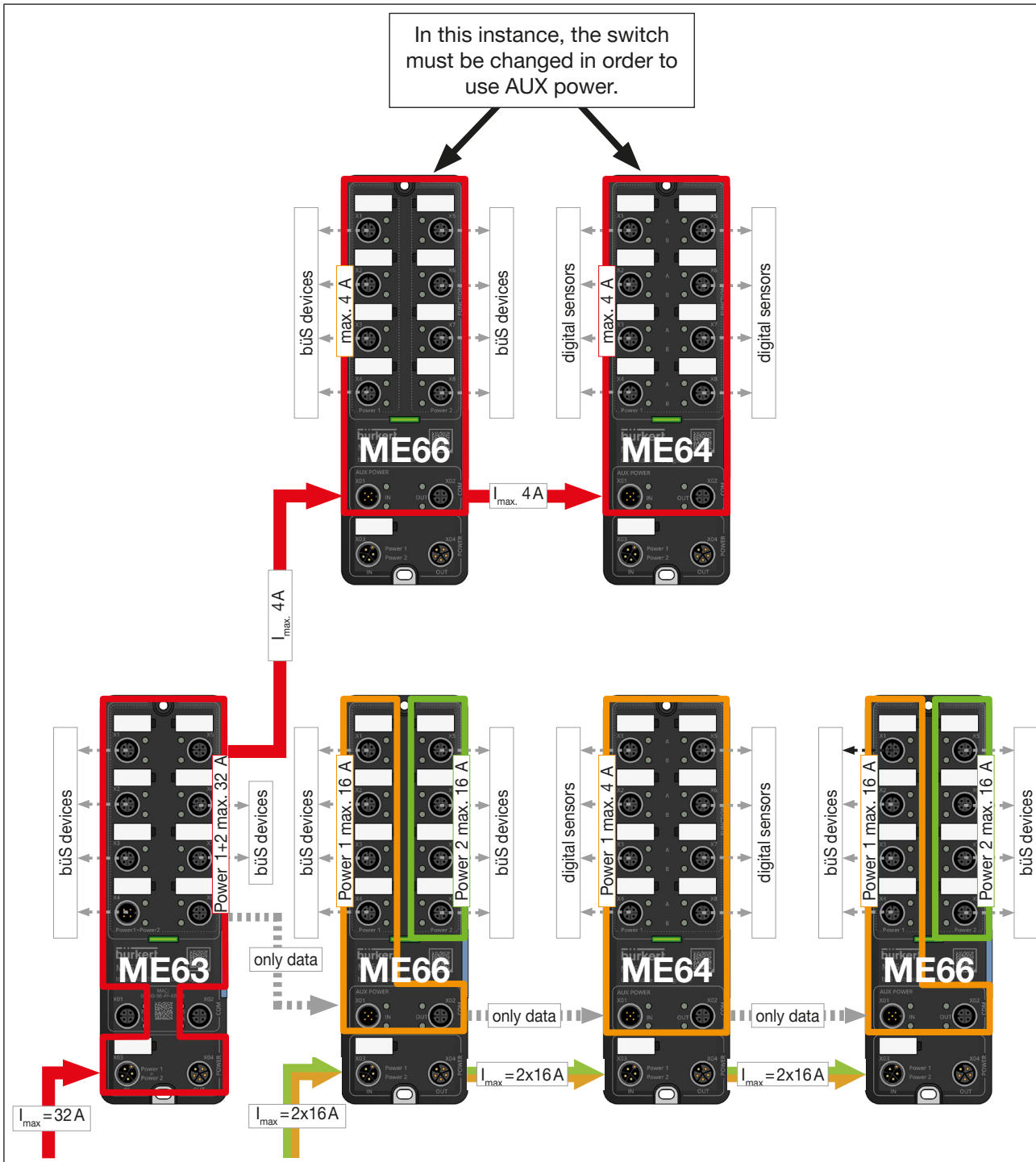

Image 9: Example for the combination of different ME modules

## 8 DISPLAY ELEMENTS

Type ME66 has the following LEDs for diagnosing the device status:

- LED for indicating the device status.

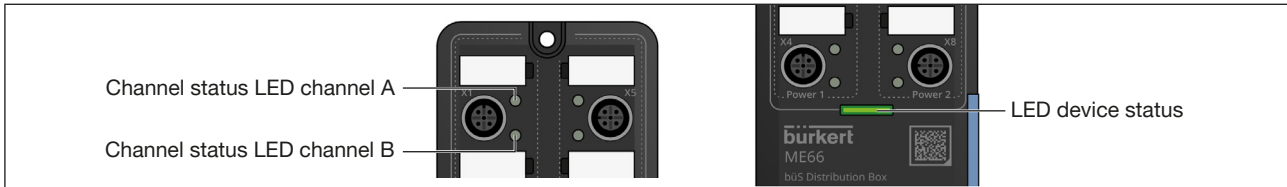

Image 10: Display elements Type ME66



Channel status LEDs have no function for ME66

### 8.1 LED for displaying device status

The LED for the device status is lit green when the outputs are supplied with current.

Power supply	Colour	Meaning
X03	green	Both supply voltages (Power 1+ Power 2) fit
	yellow	One supply voltage (Power 1 or Power 2) is missing
X01	green	One supply voltage is present and AUX switch has been changed over (to AUX power)
	yellow	AUX switch has not been changed over (to AUX power)
-	off	Device is not connected to a power supply

Table 4: Device status display

## 9 TRANSPORTATION, STORAGE, DISPOSAL

### ATTENTION

#### Transport damages.

Inadequately protected devices may be damaged during transport.

- ▶ Use shock-resistant packaging to protect the device against moisture and dirt during transport.
- ▶ Avoid exceeding or dropping below the permitted storage temperature.

#### Incorrect storage may damage the device.

- ▶ Store the device in a dry and dust-free location.

Storage temperature: -30 °C...+80 °C

### Environmentally friendly disposal



- ▶ Follow national regulations regarding disposal and the environment.
- ▶ Collect electrical and electronic devices separately and dispose of them as special waste.

Further information at [country.burkert.com](https://country.burkert.com).

