

Type 8202 ELEMENT neutrino IO-Link / büS

pH or redox meter
pH- oder Redoxpotential-Messgerät
pH- ou redox-mètre



Operating Instructions

Bedienungsanleitung
Manuel d'utilisation

We reserve the right to make technical changes without notice.
Technische Änderungen vorbehalten.
Sous réserve de modifications techniques.



© Bürkert SAS, 2023-2025

Operating Instructions 2502/02_EUml_00574524 / Original EN

1. ABOUT THIS DOCUMENT	8	4.7. pH probe, redox probe	19
1.1. Manufacturer.....	8	5. MODIFY COVER ORIENTATION AND INSTALL PROBE	19
1.2. Symbols used	8	5.1. Safety instructions	19
1.3. Terms and abbreviations	9	5.2. Unscrewing the cover on the connection box	20
2. SAFETY INSTRUCTIONS.....	9	5.3. Fitting the cover to the connection box	20
2.1. Intended use	9	5.4. Fitting the probe into the holder (without fluid)	21
2.2. Safety instructions	9	6. INSTALLATION AND WIRING	22
3. PRODUCT.....	11	6.1. Safety instructions	22
3.1. Product overview	11	6.2. Installation on the pipe	22
3.2. Product digital output	11	6.3. Fitting the electronic module to the holder	24
3.3. Type label	12	7. ELECTRICAL INSTALLATION.....	25
4. TECHNICAL DATA.....	13	8. IO-LINK COMMUNICATION	26
4.1. Conditions of use.....	13	8.1. Safety instructions	26
4.2. Standards and directives	13	8.2. Communication table	27
4.2.1. Conformity to the pressure equipment directive	13	8.3. IODD	27
4.2.2. UL certification	14	8.4. Connection to the IO-Link master.....	28
4.3. Materials.....	15	8.5. Setting and operation in IO-Link.....	28
4.4. Dimensions	16	8.5.1. Home page	28
4.5. Fluid data	16	8.5.2. Identification	29
4.6. Electrical data	18	8.5.3. Parameter	29

8.5.4. Observation	33	10.2.5. Activate display of reference impedance and glass impedance	43
8.5.5. Diagnostic	34	10.2.6. Deactivate display of reference impedance and glass impedance	44
9. SETTING AND OPERATION IN BÜS	35	10.3. Configure reaction of the device to specific events...	44
9.1. Safety instructions	35	10.3.1. Activating the monitoring of an event	44
9.2. Setting tools and setting software	36	10.3.2. Deactivating the monitoring of an event	44
9.3. Description of the user interface	36	10.4. Resetting to factory default parameter data	45
9.4. Available login user levels	36	11. SENSOR – DIAGNOSTICS	45
9.5. Product functions and menus	37	12. SENSOR – MAINTENANCE	46
10. SENSOR – PARAMETER	37	12.1. Checking the output behaviour.....	47
10.1. Setting sensor parameters	38	12.2. Calibration of the pH sensor	47
10.1.1. Sensor.....	38	12.2.1. Calibration temperature	47
10.1.2. Measurement type.....	38	12.2.2. Calibration PH sensor.....	47
10.1.3. Mains frequency	39	12.2.3. Calibration Redox ("ORP") sensor	51
10.2. Setting parameter for each measured values	39	12.2.4. Offset / Slope.....	52
10.2.1. Set the filter response time of a measured value	39	12.2.5. Setting temperature offset.....	52
10.2.2. Activating the monitoring of measured values...	40	12.3. Configure calibration schedule	52
10.2.3. Deactivating the monitoring of measured values.....	43	12.4. Resetting calibration data to factory default value	52
10.2.4. Changing the error limits, the warning limits and the hysteresis of the measured values.....	43	13. GENERAL SETTINGS – PARAMETER	53
		13.1. Changing the operating mode of the device	

status indicator or switching off the device status indicator	53	13.4.2. Changing the 2 warning limit values	58
13.1.1. Changing the operating mode of the de- vice status indicator	53	13.4.3. Reading out the hysteresis value	58
13.1.2. Switching off the device status indicator	54	13.5. Activating the diagnostics function	58
13.2. Setting the basic parameters for identifying the device on bÜS	54	13.6. Disabling all the diagnostics	59
13.2.1. Entering a name for the device	54	13.7. PDOs configuration	59
13.2.2. Entering the location of the device.....	54	13.7.1. Set the transmission time between 2 val- ues of a PDO	59
13.2.3. Entering a description for the device	54	13.7.2. Restore all PDOs to their default values	59
13.3. Setting the advanced parameters for identifying the device connected to bÜS or to a CANopen bus .	55	14. GENERAL SETTINGS – DIAGNOSTICS	60
13.3.1. Entering a unique name for the device	55	14.1. Reading out device status information	60
13.3.2. Changing the transmission speed on the device	55	14.2. Reading out bÜS status information	61
13.3.3. Changing the address of the device con- nected to a CANopen bus	56	14.3. Resetting errors counter.....	61
13.3.4. Setting the digital communication for bÜS or for a CANopen bus	56	14.4. Read the generated events	61
13.3.5. Stop sending the measured process data (PDOs) to bÜS or to the CANopen fieldbus	57	15. GENERAL SETTINGS – MAINTENANCE	63
13.4. Monitoring the supply voltage or the device temperature.....	57	15.1. Restar oduct	63
13.4.1. Reading out the 2 error limit values	57	15.2. Reset the product to its factory settings	63
		16. CALIBRATE THE DEVICE WITH A 7" PROCESS CONTROL DISPLAY TYPE ME61	64
		16.1. Safety instructions	64
		16.2. Parametrizing the calibration function	64
		16.2.1. Preparation for defining the calibration	

action on the 7" Process Control Display Type ME61 display	64	19.1.6. Message Error: too low pH	76
16.2.2. Defining a displayed process value	65	19.1.7. Message Error: too high pH	76
16.2.3. Configuring the calibration action	66	19.1.8. Message Error: too low ORP	76
16.2.4. Using the calibration menu on the 7" Pro- cess Control Display Type ME61	68	19.1.9. Message Error: too high ORP	77
17. PROCESS DATA OBJECTS	70	19.1.10. Message Error: too low temperature	77
17.1. Transmitted PDOs	70	19.1.11. Message Error: too high temperature	77
17.2. Structure of the PDO4	70	19.1.12. Message Error: too low voltage	77
18. MAINTENANCE	72	19.1.13. Message Error: too high voltage	78
18.1. Safety instructions	72	19.1.14. Message Error: too low reference im- pedance	78
18.2. Cleaning the device	72	19.1.15. Message Error: too high reference impedance	78
18.3. Replacing the probe	73	19.1.16. Message Error: too low glass impedance ...	78
18.4. Replacing the seal in the probe holder	74	19.1.17. Message Error: too high glass impedance ..	79
19. TROUBLESHOOTING WITH MESSAGES	75	19.2. Messages  : function check	79
19.1. Messages  : failure, error or malfunction	75	19.2.1. Message Simulation mode active	79
19.1.1. Message büS is not operational	75	19.3. Messages  : out of specification	79
19.1.2. Message Factory data failure	75	19.3.1. Message Warning: too low pH	79
19.1.3. Message Temperature failure	75	19.3.2. Message Warning: too high pH	79
19.1.4. Message Sensor connection lost	75	19.3.3. Message Warning: too low ORP	80
19.1.5. Message Measurement saturation error	76	19.3.4. Message Warning: too high ORP	80

19.3.5. Message	Warning: too low temperature	80
19.3.6. Message	Warning: too high temperature	80
19.3.7. Message	Warning: too low voltage	81
19.3.8. Message	Warning: too high voltage	81
19.3.9. Message	Warning: too low reference impedance	81
19.3.10. Message	Warning: too high reference impedance	81
19.3.11. Message	Warning: too low glass impedance	82
19.3.12. Message	Warning: too high glass impedance	82
19.4. Messages	 : maintenance required	82
19.4.1. Message	Calibration date has expired	82
20. SPARE PARTS AND ACCESSORIES		82
21. PACKAGING, TRANSPORT		83
22. STORAGE		83
23. DISPOSAL		84

1. ABOUT THIS DOCUMENT

The document is an important part of the product and guides the user to safe installation and operation. The information and instructions in this document are binding for the use of the product.

- Before using the product for the first time, read and observe the whole safety chapter.
- Before starting any work on the product, read and observe the respective sections of the document.
- Keep the document available for reference and give it to the next user.
- Contact the Bürkert sales office for any questions.



Further information concerning the product at country.burkert.com.

1.1. Manufacturer

Bürkert SAS

20, rue du Giessen
F-67220 TRIEMBACH-AU-VAL

The contact addresses are available at country.burkert.com in the menu Contact.

1.1. Symbols used



DANGER

Warns of a danger that leads to death or serious injuries.



WARNING

Warns of a danger that can lead to death or serious injuries.



CAUTION

Warns of a danger that can lead to minor injuries.

NOTICE

Warns of property damage that can damage the product or the installation.



Indicates important additional information, tips and recommendations.



Refers to information in this document or in other documents.

► Indicates an instruction to be carried out to avoid a danger, a warning or a possible risk.

→ Indicates a step to be carried out.



Indicates the result of a specific instruction.

Menu Identifies a text of a user interface.

1.2. Terms and abbreviations

The terms and abbreviations are used in this document to refer to following definitions.

Device Type 8202 ELEMENT neutrino IO-Link – büS.

2. SAFETY INSTRUCTIONS

2.1. Intended use

Use of the device that does not comply with the instructions could present risks to people, nearby installations and the environment.

The device is intended solely for the measurement of the conductivity of liquids.

- ▶ Use the device in compliance with the characteristics and start-up and use conditions specified in the contractual documents and in the Operating Instructions.
- ▶ Do not use the device for security applications.
- ▶ Store, transport, install and operate the device properly.
- ▶ Only operate a device in perfect working order.
- ▶ Only use the device as intended.

2.2. Safety instructions

This safety information does not take into account any contingencies or occurrences that may arise during installation, use and maintenance of the product.

The operating company is responsible for the respect of the local safety regulations including for the staff safety.



Risk of injury due to electrical voltage.

- ▶ If the device is installed either in a wet environment or outdoors, all the electrical voltages must be of max. 35 V DC.
- ▶ Before carrying out work on the system or the device, disconnect the electrical power for all the conductors and isolate it.
- ▶ All equipment connected to the device must be double insulated with respect to the mains according to the standard UL/EN 61010-1.
- ▶ Observe all applicable accident protection and safety regulations for electrical equipment.

Risk of injury due to pressure in the installation.

- ▶ Before any intervention in the installation, stop the circulation of fluid, cut off the pressure and drain the pipe.
- ▶ Before any intervention in the installation, make sure there is no pressure in the pipe.
- ▶ Observe the dependency between the fluid temperature and the fluid pressure.



Risk of burns due to high fluid temperatures.

- ▶ Use safety gloves to handle the device.
- ▶ Before opening the pipe, stop the circulation of fluid and drain the pipe.
- ▶ Before opening the pipe, make sure the pipe is completely empty.

Risk of injury due to the nature of the fluid.

- ▶ Respect the prevailing regulations on accident prevention and safety relating to the use of dangerous fluids.



Various dangerous situations

To avoid injury, observe the following instructions:

- ▶ Do not use the device in explosive atmospheres.
- ▶ Do not use the device in an environment incompatible with the device materials.
- ▶ Do not use fluid that is incompatible with the device materials. Find the compatibility chart on our homepage: country.burkert.com.
- ▶ Do not subject the device to mechanical stress.
- ▶ Do not make any modifications to the device.
- ▶ Prevent any unintentional power supply switch-on.



Various dangerous situations

To avoid injury take care:

- ▶ Only qualified and skilled staff may carry out the installation and maintenance work.
- ▶ Ensure a defined or controlled restarting of the process after a power supply interruption.
- ▶ Observe the general technical rules.

NOTICE

Elements and components that are both sensitive to electrostatic discharges

The device contains electronic components that are sensitive to electrostatic discharges. The components may be damaged if they are touched by an electrostatically charged person or object. In the worst case scenario, the components are instantly destroyed or go out of order as soon as they are activated.

- ▶ To minimise or even avoid all damage due to an electrostatic discharge, take all the precautions that are described in the EN 61340-5-1 norm.
- ▶ Do not touch any of the live electrical components.

3. PRODUCT

3.1. Product overview

The device comprises:

- A module for converting physical parameters, comprising:
 - A pH probe or redox probe that converts the pH or the redox potential of the fluid into differences in potential (PD in mV). The differences in potential are then transmitted to the PD acquisition/conversion module;
 - A Pt1000 temperature probe integrated in the probe holder which converts the temperature of the fluid into resistance (in Ω).
- A PD acquisition / conversion module:
 - PD acquisition measured in mV;
 - Conversion of the measured PD into pH units with temperature compensation (for a device with pH probe only)
 - Acquisition of the resistance in Ω and conversion into $^{\circ}\text{C}$.

The device requires an operating voltage of 12...36 V DC. Electrical connection is made over a 4-pin or 5-pin M12 male connector.

The device can be fitted with a standard probe 120 mm long, measuring the pH or the oxidation reduction potential. It is screwed into a holder with the built-in Pt1000 temperature probe.

- The pH probe is a glass membrane with variable selectivity according to the pH. When the pH probe is immersed in a solution, a difference in potential is formed, due to the hydrogen ions (H^+), between the glass membrane and the

solution. This difference in potential, measured in relation to a reference electrode, is directly proportional to the pH value (59.16 mV per pH unit at 25 $^{\circ}\text{C}$).

- When a Redox probe is immersed in a solution, an exchange of electrons occurs between the oxidised form and the reduced form of an electrolyte. The resulting voltage is the oxidation reduction potential.

3.2. Product digital output

The product can communicate via bÜS/CANopen or IO-Link.



- Devices with box in PPS and M12 connector in PA66 (see chapter 4.3) are dedicated to a use in IO-Link only.
- Devices with box in steel and M12 connector in Nickel-plated brass (see chapter 4.3) can be used either in IO-Link or in bÜS.

The device automatically switches from bÜS to IO-Link according to the master wired to it.

According to the master that is connected, the device LED, on the top cover of the device, blinks orange at start:

- 4 times when a bÜS master is connected
- 2 times when a IO-Link master is connected.

After this, the device LED will indicate the NAMUR state of the device.

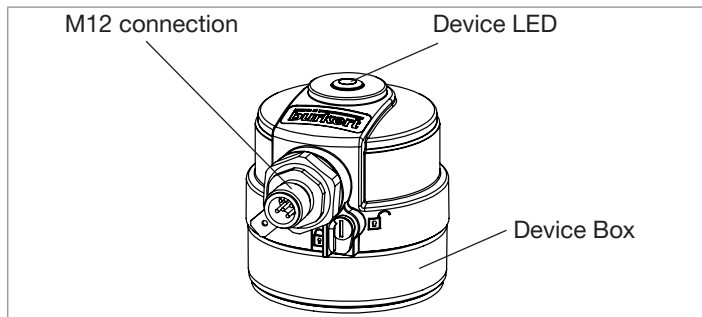

3.3. Type label

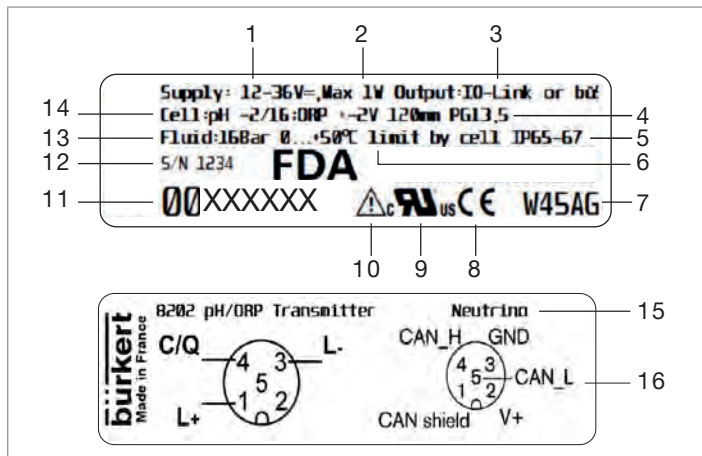

1. Operating voltage
2. Power consumption
3. Output type
4. Measuring range
5. IP-Code
6. Fluid temperature
7. Manufacturing code
8. Conformity marking
9. Certification
10. Warning: Before using the device, take into account the technical specifications described in these Operating Instructions
11. Article number
12. Serial number
13. Nominal pressure of the fluid
14. Constant of the measuring cell
15. Type of the device and measured quantity
16. Pin assignment of the electrical connection

Fig. 1: Type label (example)

4. TECHNICAL DATA

4.1. Conditions of use

Ambient temperature	-10...+60 °C, without pH probe or redox probe
Air humidity	< 85 %, without condensation
Operating condition	Continuous operation
Mobility of the device	Fixed device
Use	Indoor and outdoor. <ul style="list-style-type: none"> ▶ Protect the device against electromagnetic interference, ultraviolet rays and, when installed outdoors, the effects of the climatic conditions.
<ul style="list-style-type: none"> • IP-Code • NEMA protection type <p>¹⁾ not evaluated by UL</p>	<ul style="list-style-type: none"> • IEC / EN 60529: IP67 ¹⁾ and IP65 ¹⁾ • NEMA 250: 4X and 6P <p>Mating female connector must be wired and plugged.</p> <p>Cover of the connecting box must be fully tightened and locked.</p>
Degree of pollution	Degree 2 according to UL/EN 61010-1
Installation category	Category I according to UL/EN 61010-1
Maximum height above sea level	2000 m

4.2. Standards and directives

The device complies with the relevant EU harmonisation legislation. In addition, the device also complies with the requirements of the laws of the United Kingdom.

The harmonised standards that have been applied for the conformity assessment procedure are listed in the current version of the EU Declaration of Conformity/UK Declaration of Conformity.

4.2.1. Conformity to the pressure equipment directive

- ▶ Make sure that the device materials are compatible with the fluid.
- ▶ Make sure that the pipe DN is adapted for the device.
- ▶ Observe the nominal pressure (PN) of the fluid for the device. The nominal pressure (PN) of the fluid is given by the device manufacturer.

The device conforms to Article 4, Paragraph 1 of the Pressure Equipment Directive 2014/68/EU under the following conditions:

- Device used on a pipe (PS = maximum admissible pressure in bar; DN = nominal dimension of the pipe in mm)

Type of fluid	Conditions
Fluid group 1, Article 4, Paragraph 1.c.i	DN ≤ 25
Fluid group 2, Article 4, Paragraph 1.c.i	DN ≤ 32 or PSxDN ≤ 1000

Type 8202 ELEMENT neutrino

Technical data

Type of fluid	Conditions
Fluid group 1, Article 4, Paragraph 1.c.ii	$DN \leq 25$ or $PS \times DN \leq 2000$
Fluid group 2, Article 4, Paragraph 1.c.ii	$DN \leq 200$ or $PS \leq 10$ or $PS \times DN \leq 5000$



- Device used on a vessel (PS = maximum admissible pressure in bar; V = vessel volume in L)

Type of fluid	Conditions
Fluid group 1, Article 4, Paragraph 1.a.i	$V > 1$ and $PS \times V \leq 25$ or $PS \leq 200$
Fluid group 2, Article 4, Paragraph 1.a.i	$V > 1$ and $PS \times V \leq 50$ or $PS \leq 1000$
Fluid group 1, Article 4, Paragraph 1.a.ii	$V > 1$ and $PS \times V \leq 200$ or $PS \leq 500$
Fluid group 2, Article 4, Paragraph 1.a.ii	$PS > 10$ and $PS \times V \leq 10000$ or $PS \leq 1000$

4.2.2. UL certification

Devices with variable key PU01 or PU02 are UL-certified devices and comply also with the following standards:

- UL 61010-1
- CAN/CSA-C22.2 n°61010-1

Identification on the device	Certification	Variable key
	UL-recognized	PU01
 Measuring Equipment EXXXXXX	UL-listed	PU02

4.3. Materials

Component	Material
Box / seals	Stainless steel, PPS / EPDM
Cover / seal	PPS / EPDM
M12 male connector / seal	PA66 or Nickel-plated brass / EPDM
Grounding terminal	Nickel-plated brass
Light guide	PC and PMMA
Nut	<ul style="list-style-type: none"> • PVC • PVDF on request
Probe holder / seal	PVDF, Stainless steel 1.4571 (316Ti) / EPDM
pH probe or redox probe	Refer to the related Operating Instructions

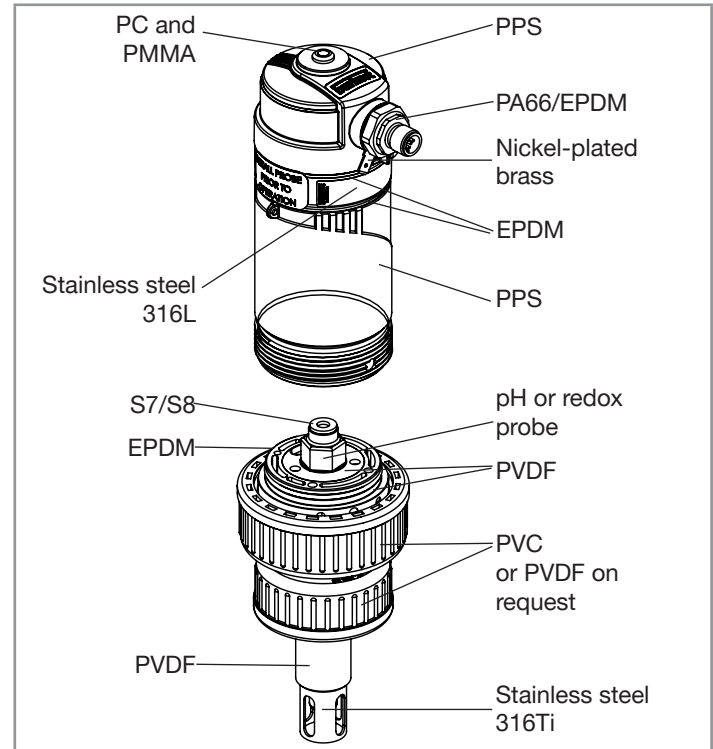

Fig. 2: Device materials

4.4. Dimensions

→ Refer to the data sheet of the device, available at:

country.burkert.com

4.5. Fluid data

Fluid pressure	<p>PN16 ²⁾</p> <p>The fluid pressure may be restricted by the probe used and the fitting used. Refer to the related Operating Instructions.</p> <p>The fluid pressure may be restricted by the material of the nut and the fluid temperature. Refer to Fig. 3, Fig. 4 and Fig. 5.</p>
²⁾ not evaluated by UL	
Fluid temperature	
<ul style="list-style-type: none"> • Device variant with a PVC nut 	<ul style="list-style-type: none"> • 0...+50 °C <p>The fluid temperature may be restricted by the probe used and the fitting used. Refer to the related Operating Instructions.</p> <p>The fluid temperature may be restricted by the fluid pressure. Refer to Fig. 3 and Fig. 4.</p>

<ul style="list-style-type: none"> • Device variant with a PVDF nut 	<ul style="list-style-type: none"> • -20...130 °C <p>The fluid temperature may be restricted by the probe used and the fitting used. Refer to the related Operating Instructions.</p> <p>The fluid temperature may be restricted by the fluid pressure. Refer to Fig. 3 and Fig. 5.</p>
pH measurement	
<ul style="list-style-type: none"> • Measurement range • Accuracy 	<ul style="list-style-type: none"> • 0...14 pH • ±0.05 pH
Redox potential measurement	
<ul style="list-style-type: none"> • Measurement range • Accuracy 	<ul style="list-style-type: none"> • -2000...+2000 mV • ±3 mV
Temperature probe	Pt1000 integrated in the probe holder
Temperature measurement	
<ul style="list-style-type: none"> • Measurement range • Accuracy 	<ul style="list-style-type: none"> • -40...+130 °C • ±1 °C
Temperature compensation	<ul style="list-style-type: none"> • Automatic (integrated Pt1000) • Reference temperature = 25 °C

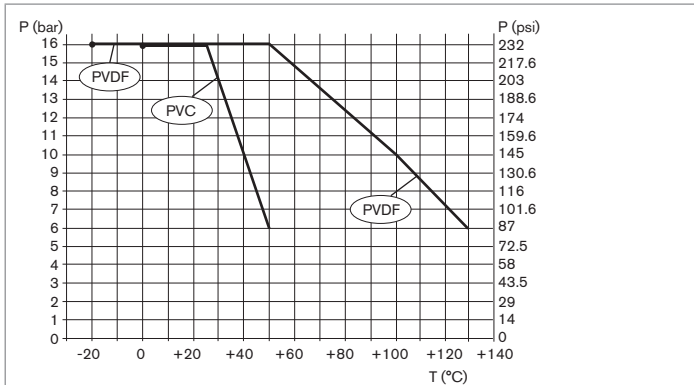

These measurements were taken at an ambient temperature of 60 °C.

Fig. 3: Dependency between the fluid temperature and the fluid pressure, device variant with a PVC nut or device variant with a PVDF nut, without probe

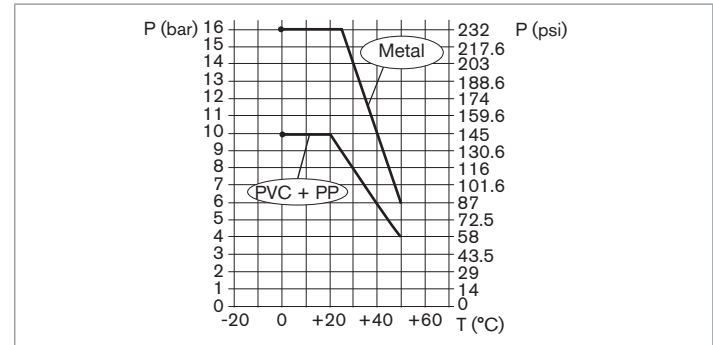

Fig. 4: Dependency between the fluid temperature and the fluid pressure, device variant with a PVC nut, without probe, with a Type S022 in metal, PVC or PP

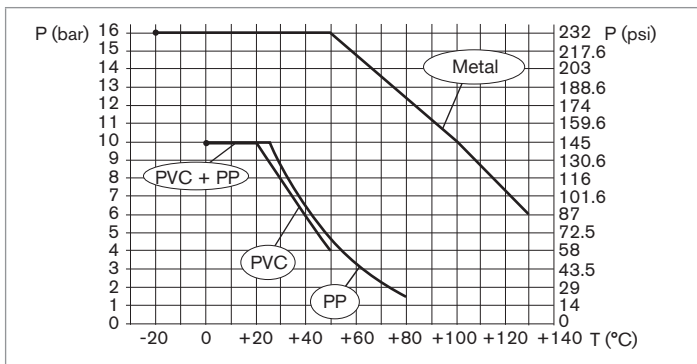

Fig. 5: Dependency between the fluid temperature and the fluid pressure, device variant with a PVDF nut, without probe, with a Type S022 in metal, PVC or PP

4.6. Electrical data

Operating voltage	<ul style="list-style-type: none"> • 12...36 V DC • Connection to main supply: permanent through external safety extra-low voltage (SELV) and through limited power source (LPS) • Filtered and regulated
Power consumption	≤ 1 W
Power source (not supplied)	<ul style="list-style-type: none"> • Limited power source according to UL/EN 60950-1 standard • or limited energy circuit according to UL/EN 61010-1, Paragraph 9.4
Protection against polarity reversal	Yes
Protection against spike voltages	Yes
Digital output	büS / IO-Link V1.1.2

Type 8202 ELEMENT neutrino

Modify cover orientation and install probe

4.7. pH probe, redox probe



The specifications of Bürkert probes can be found in the related Operating Instructions.

The device must be used with a pH or redox probe that satisfies the following specifications:

- combined probe;
- length: 12 mm;
- with PG 13.5 head;
- with an S7/S8 connector;
- without temperature probe.

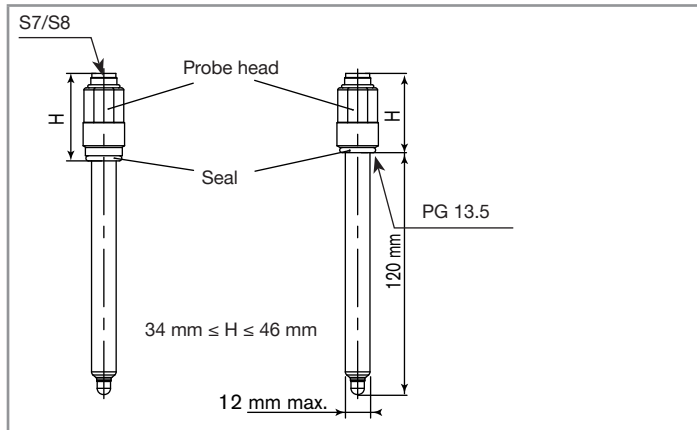

Fig. 6: Specifications of the pH probe or redox probe

5. MODIFY COVER ORIENTATION AND INSTALL PROBE

5.1. Safety instructions



DANGER

Risk of injury due to electrical voltage.

- ▶ If the device is installed either in a wet environment or outdoors, all the electrical voltages must be of max. 35 V DC.
- ▶ Before carrying out work on the system or the device, disconnect the electrical power for all the conductors and isolate it.
- ▶ All equipment connected to the device must be double insulated with respect to the mains according to the standard UL/EN 61010-1.
- ▶ Observe all applicable accident protection and safety guidelines for electrical equipment.



WARNING

Risk of injury due to non-conforming assembly.

- ▶ The device must only be assembled by qualified and skilled staff with the appropriate tools.
- Risk of injury due to unintentional switch on of power supply or uncontrolled restarting of the installation.
- ▶ Take appropriate measures to avoid unintentional activation of the installation.
 - ▶ Guarantee a set or controlled restarting of the process subsequent to any intervention on the device.

5.2. Unscrewing the cover on the connection box

NOTICE

The tightness of the device is not guaranteed when the cover is removed.

- ▶ Take any precautions necessary to prevent the projection of liquid inside the box.

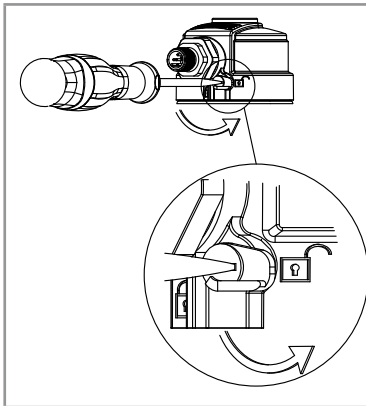

The connection box is fitted with a locking system.

- Using a screwdriver with a suitable head, unlock the connection box by turning the latch to the unlock position.

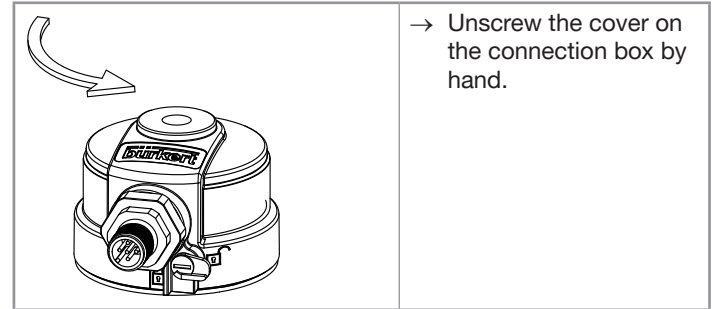

- Unscrew the cover on the connection box by hand.

Fig. 7: Unscrewing the cover on the connection box

5.3. Fitting the cover to the connection box

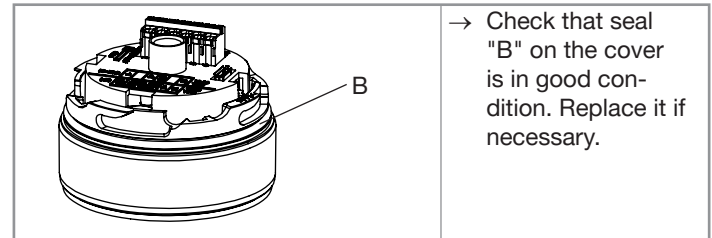

- Check that seal "B" on the cover is in good condition. Replace it if necessary.

Type 8202 ELEMENT neutrino
 Modify cover orientation and install probe

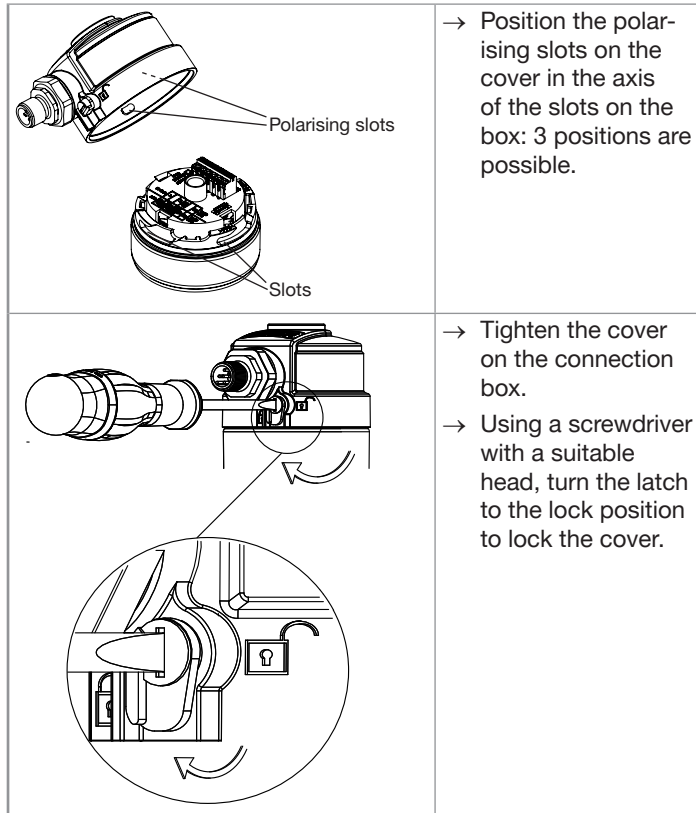

Fig. 8: Fitting the cover on the connection box

5.4. Fitting the probe into the holder (without fluid)

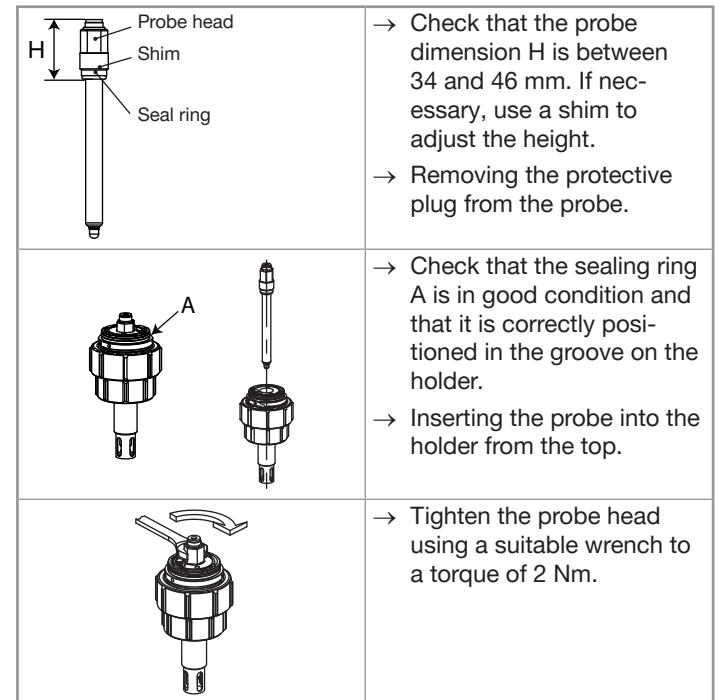

Fig. 9: Fitting the probe into the holder (without fluid)

6. INSTALLATION AND WIRING

6.1. Safety instructions



DANGER

Risk of injury due to pressure in the installation

- ▶ Stop the circulation of fluid and depressurize the pipes before loosening the process connections.

Risk of injury due to electrical voltage.

- ▶ If the device is installed either in a wet environment or outdoors, all the electrical voltages must be of max. 35 V DC.
- ▶ Before carrying out work on the system or the device, disconnect the electrical power for all the conductors and isolate it.
- ▶ All equipment connected to the device must be double insulated with respect to the mains according to the standard UL/EN 61010-1.
- ▶ Observe all applicable accident protection and safety guidelines for electrical equipment.

Risk of injury due to the nature of the fluid.

- ▶ Respect the regulations on accident prevention and safety relating to the use of aggressive fluids.

Risk of injury due to high fluid temperatures.

- ▶ Use safety gloves to handle the device.



WARNING

Risk of injury due to non-conforming installation.

- ▶ The electrical and fluid installation can only be carried out by qualified and skilled staff with the appropriate tools.
- ▶ Install appropriate safety devices (correctly rated fuse and/or circuit-breaker).
- ▶ Respect the assembly instructions for the fitting used.

Risk of injury due to unintentional switch on of power supply or uncontrolled restarting of the installation.

- ▶ Take appropriate measures to avoid unintentional activation of the installation.
- ▶ Guarantee a set or controlled restarting of the process subsequent to any intervention on the device.

6.2. Installation on the pipe



WARNING

Risk of injury if the dependency between the fluid pressure and the fluid temperature is not respected.

- ▶ Take account of the dependency curves between the fluid temperature and fluid pressure. Refer to chapter 4.5.
- ▶ Comply with the Pressure Equipment Directive 2014/68/EU.

NOTICE

The device may be irretrievably damaged if it is installed in the pipe without the probe.

- ▶ Always install the device in the pipe fitted with a probe.



If a pH/redox probe (with PG 13.5 head, 120 mm long and without temperature probe) from a supplier other than Bürkert is used, follow the relevant instructions on installation in the pipe.



If the pH or oxidation reduction potential is measured in liquids containing solids that may leave deposits in the bottom of the pipe, use installation position 1 (see Fig. 10).



The probe must always be immersed in the fluid to prevent it drying out.

The device is inserted into a Type S022 fitting installed into the pipe.

- Choose an appropriate position in the pipe to install the fitting (see Fig. 10).

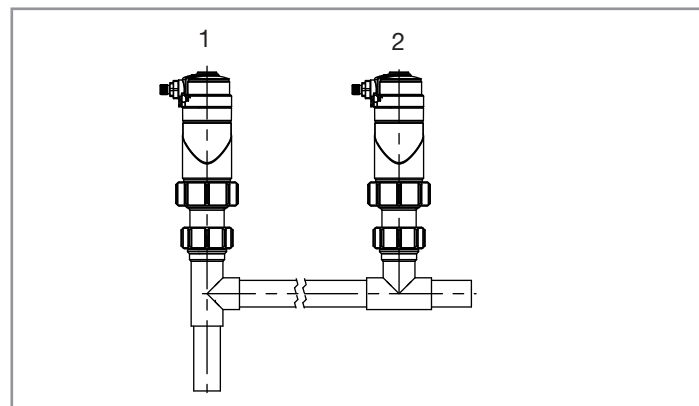

Fig. 10: Mounting positions of the fitting/device unit in the pipe.

- Install the fitting in the pipe at an angle of $\pm 75^\circ$ max. to the vertical (see Fig. 11) in accordance with the instructions in the Operating Instructions for the fitting used.

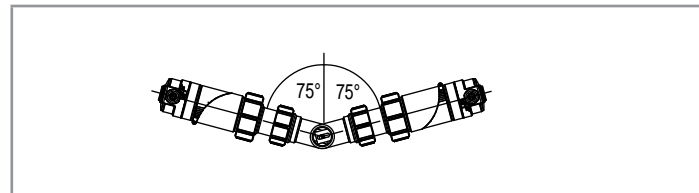

Fig. 11: Angle to the vertical

- Fitting the probe into the holder (see chapter 5.4).
- Installing the holder, with its probe, in the fitting (see Fig. 12).

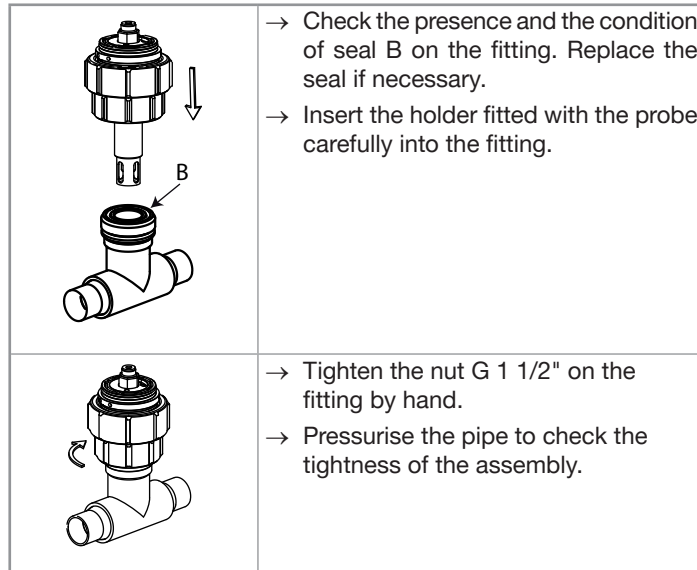
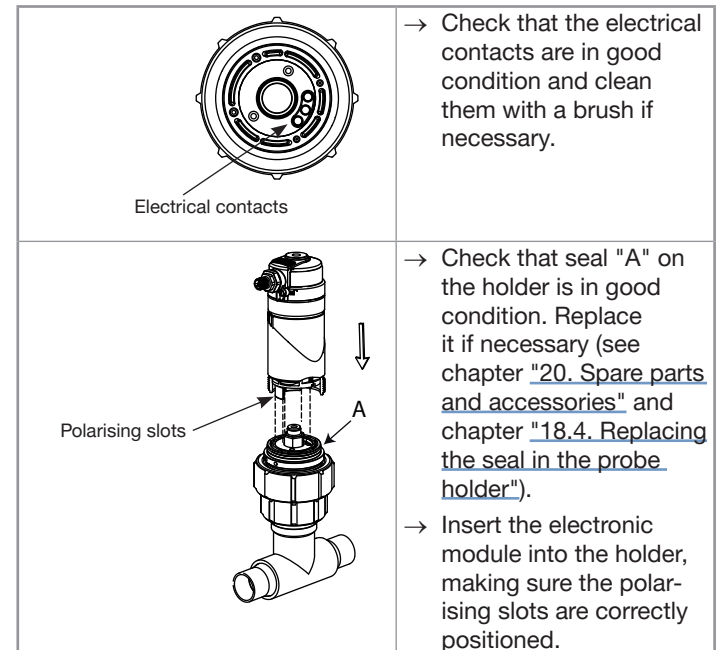
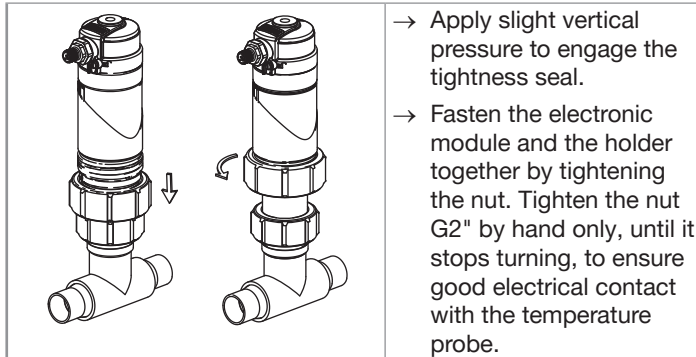

Fig. 12: Installation of the probe holder in a fitting

6.3. Fitting the electronic module to the holder





- Apply slight vertical pressure to engage the tightness seal.
- Fasten the electronic module and the holder together by tightening the nut. Tighten the nut G2" by hand only, until it stops turning, to ensure good electrical contact with the temperature probe.

Fig. 13: Fitting the electronic module to the holder

→ Calibrate the probe (see chapter [18](#)).

7. ELECTRICAL INSTALLATION

To communicate in büS / CANopen or IO-Link, the following wiring must be done:

	büS / CANopen	IO-Link
	<ul style="list-style-type: none"> • Pin 1: CAN shield • Pin 2: 12...36 V DC • Pin 3: GND • Pin 4: CAN_H • Pin 5: CAN_L 	<ul style="list-style-type: none"> • Pin 1: L+ from voltage supply • Pin 2: Do not use • Pin 3: L- from voltage supply • Pin 4: C/Q • Pin 5: Do not use

The device automatically switches from büS to IO-Link according to the master wired to it.

If available, connect the grounding connector to the local earth.

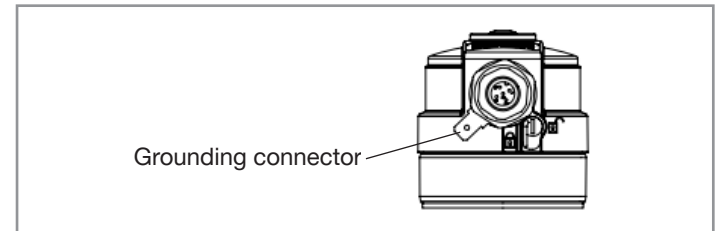

8. IO-LINK COMMUNICATION

The device can be used in bÜS or IO-Link communication system and will automatically recognize the connected master.

The following elements are dedicated to the IO-Link communication aspects.

The pH/ORP sensor is equipped with an IO-Link interface which has to be connected to an IO-Link master and can be used to exchange process data, parameters, diagnostic information and status message.



More information on IO-Link is available at:
www.io-link.com

8.1. Safety instructions



DANGER

Risk of injury from electric shocks.

- ▶ Before working on the installation or product, switch off the power supply. Make sure that nobody can switch the power supply on.
- ▶ Observe all applicable accident protection and all applicable safety regulations for electrical equipment.

NOTICE

Risk of injury from improper operation

Improper operation can lead to injuries and damage to the product and its environment.

- ▶ Before commissioning, make sure that the operating personnel are familiar with, and fully understand the content of the Operating Instructions.
- ▶ Observe the safety information and the intended use.
- ▶ Only properly trained personnel may commission the installation and the product.
- ▶ Only properly trained personnel may change parameters with the help of the IO-Link master or the software Bürkert Communicator Type 8920. Refer to IO-Link instruction manual for associated safety instructions.

8.2. Communication table

Port Class	A
IO-Link specification	V1.1.2
Supply	via IO-Link (M12 x 1, 5-pin, A-coded)
SIO-Mode	No
IODD-File	see Internet
VendorID	0x0078, 120
DeviceID	see IODD file
ProductID	8202 Class A
Transmission speed	COM3 (230.4 kbit/s)
PD Input Bits	48
PD Output Bits	8
M-sequence Cap.	0x0D
Min. cycle time	5 ms
Data storage	Yes
Max. cable length	20 m

8.3. IODD

To ensure a proper work between the sensors and the Master IO-Link, the IO-Link system needs a description of the device parameters, such as output and input data, data format, data volume and supported transfer rate.

These data are available in the device master called IODD (for IO Device Description), provided to the IO-Link master when the communication system is commissioned.

Downloading the IODD:

- Go to web page country.burkert.com.
 - Select your country.
 - Click on continue the website.
 - Confirm or change cookie settings.
 - Enter the device type number, e.g. 8202 (see device nameplate) in the search field.
 - Click on the first result of the search.
 - In the area **Software** download the ZIP file **Device Description**.
 - Unpack the ZIP file (all or just the IODD file).
 - Identify and select the required IODD via IO-Link Device ID (see device nameplate).
- The IODD is now available for use with the IO-Link master's configuration tool. This can be used to configure and check the device.



Instead of the manufacturer's website, you can also use the address: ioddfinder.io-link.com.

8.4. Connection to the IO-Link master

If you are using a conventional IO-Link master, you must complete the following steps to configure the sensor.

- Start up the hardware and software for the IO-Link master.
- Load the sensor's device description file (IODD): see chapter 8.3 "Downloading the IODD".
- Start the configuration tool.
- Update the device catalog (import the IODD; localize using the "device ID" on the nameplate or the text file in the IODD collection).
- Create a new project.
- Establish a connection.
- Configure, extract, monitor, etc., the sensor.

8.5. Setting and operation in IO-Link

The following chapters and associated pictures illustrate the different functionalities which should be available on the IO-Link master after proper connection of the sensor.



Several IO-Link masters are available on the market and can conduct to different graphical interfaces but the structure of the menus and sub-menus should remain the same. The illustrations below could therefore be different to those obtained with another IO-Link master.

8.5.1. Home page

The main page of the IO-Link master provides information on the IO-Link master used and to some general information on the sensor connected.

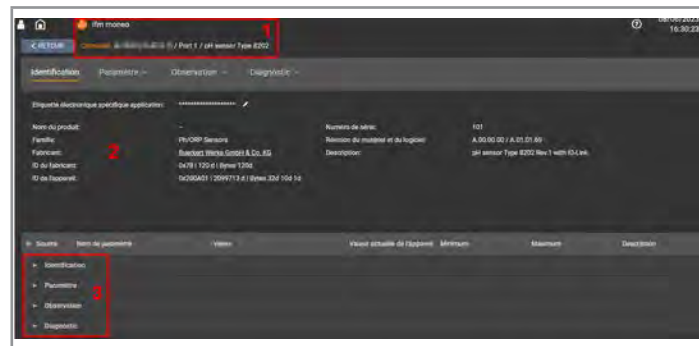

- Area 1 refers to the IO-Link master used and the sensor connected to it.
- Area 2 indicates general information related to the sensor.
- Area 3 corresponds to the different menus available for the sensor.

The menu is organized around 4 main topics:

- **Identification**, refer to chapter 8.5.2.
- **Parameter**, refer to chapter 8.5.3.
- **Observation**, refer to chapter 8.5.4.
- **Diagnostic**, refer to chapter 8.5.5.

Those menus are described hereafter.

8.5.2. Identification

The **Identification** menu provides access to read-only information related to the sensor.

Detailed view of the **Identification** menu:

Parameter	Description
Buerkert Device Description Object	
Name	Measurement type
Ident. number	Product article-number
Manufacture date	Product manufacturing-date
Firmware ident. number	Article number of the product software
Firmware version	Version number of the product software
Hardware version	Version number of the product hardware
Serial number	Product serial-number
Product type	Type of the product

8.5.3. Parameter

The **Parameter** menu provides access to the following functionalities:

- Sensor type – measurement type – mains frequency
- Measure values
- Events
- Calibration
- Simulation
- General settings
- Specialist

Those menus are described hereafter.

- In the first part of the **Parameter** menu, the sensor type can be selected between **pH** and **ORP** (the sensor needs to be restarted after a change from Sensor type: **General settings** ----- ► **Reboot device**). The sensor parameters mode corresponds to the measurement type necessary (symmetrical or asymmetrical):
 - The symmetrical measurement is a differential measurement: In this type of measurement, the stainless steel ring on the sensor holder is used as a reference.
 - In the asymmetrical measurement, the measurement is done in relation to the reference electrode.

For more detailed information, refer to the corresponding chapter in büS (see chapter [10.1.2](#)).

Type 8202 ELEMENT neutrino

IO-Link communication

- Sensors parameters frequency is used to select the frequency of mains electricity.

For more detailed information, please refer to the corresponding chapter in büS (see chapter [10.1.3](#)).

Detailed view of the **Measure values** submenu:

Setting	
pH	
Temperature	
Voltage	
Reference impedance	
Glass impedance	

This section allows to set the following parameters for each listed measured value: filter response time and limits.

To handle measured values aspects and for more described elements, please refer to the corresponding chapter in büS (chapter [10.2](#)).

Detailed view of the **Events** submenu:

Setting	
Events. Sensor connection lost	<ul style="list-style-type: none">• Disabled• Enabled
Events. Factory data failure	<ul style="list-style-type: none">• Disabled• Enabled
Events. Temperature sensor failure	<ul style="list-style-type: none">• Disabled• Enabled
Events. Measurement saturation	<ul style="list-style-type: none">• Disabled• Enabled

This section gives the possibility to activate or deactivate the monitoring of the listed events that could have an impact on the trueness of the values measured by the sensor.

To handle events aspects and for more described elements, please refer to the corresponding chapter in büS (chapter [10.3](#)).

Detailed view of the **Calibration** submenu:

Setting	
Calibration. Temperature mode	<ul style="list-style-type: none">• Process• Constant
Calibration. Temperature constant	
Calibration. pH offset	
Calibration. pH slope	
Calibration. Temperature offset	
Calibration. Interval in days	

This section gives access to the following calibration coefficients:

- Temperature calibration mode
- pH/ORP offset
- pH slope
- Temperature offset
- Calibration schedule

To handle calibration aspects and for more described elements, please refer to the corresponding chapter in büS (chapter [12.2](#)).

Please note that 1-point calibration and 2-point calibration cannot be performed by the use of an IO-Link master. Those have to be done through büS communication using a PC with software Bürkert Communicator Type 8920.

→ Please refer to the corresponding chapters described hereafter for büS.

→ For further information, refer to the Operating Instructions of the Type 8920.

Temperature compensation allows to choose between:

- either the temperature measured: select **Process**,
- or a fixed value: select **Constant**, then enter the reference temperature.

For more detailed information, please refer to the corresponding chapter in büS (see chapter [12.2.1](#))

Calibration pH slope and calibrate pH offset allows to enter the values available on the pH/ORP sensor. For more detailed information, please refer to the corresponding chapter in büS (see chapter [12.2.4](#)).

The interval in days can be configurable for the calibration schedule. When the entered value is 0, the function is deactivated. For more detailed information, please refer to the corresponding chapter in büS (see chapter [12.3](#)).

Detailed view of the **Simulation** submenu:

Setting	
Simulation. pH	<ul style="list-style-type: none"> Inactive Active
	pH. Simulation value
Simulation. ORP	<ul style="list-style-type: none"> Inactive Active
	ORP. Simulation value
Simulation. Temperature	<ul style="list-style-type: none"> Inactive Active
	Temperature. Simulation value
Simulation. Voltage	<ul style="list-style-type: none"> Inactive Active
	Voltage. Simulation value
Simulation. Reference impedance	<ul style="list-style-type: none"> Inactive Active
	Reference impedance. Simulation value
Simulation. Glass impedance	<ul style="list-style-type: none"> Inactive Active
	Glass impedance. Simulation value

Simulation menu provides the possibility to simulate process values.

To handle simulation aspects and for more described elements, please refer to the corresponding chapter in büS (chapter [12.1](#)).

Detailed view of the **General settings** submenu:

Setting		
General settings	Reboot device	
	Reset to factory	
Status LED	Mode	Refer to büS, chapter 13.1 .
	Color	
Device temperature	Limits. Error low	Refer to büS, chapter 13.4 .
	Limits. Error high	
	Limits. Warning low	
	Limits. Warning high	
Supply voltage	Limits. Hysteresis	Refer to büS, chapter 13.4 .
	Limits. Error low	
	Limits. Error high	
	Limits. Warning low	
	Limits. Warning high	
	Limits. Hysteresis	
System bus		
Specialist	Application specific marking	

This section provides the possibility to reboot the sensor or to reset the sensor to factory settings. To handle Factory reset and for more described elements, please refer to the corresponding chapter in büS (chapter 10.4). This section allows also to interact on the Status LED, monitor device temperature and voltage and set associated error and warning limits.

The **Specialist** menu has no influence on the functionalities of the sensor and should not be modified.

8.5.4. **Observation**

The **Observation** menu provides read access to the following events status:

- Sensor connection error
- Factory data error
- Temperature sensor error
- Measurement saturation error

This section allows the possibility to activate or deactivate diagnostics to the mentioned functionalities. If those events are activated, associated error messages could be generated. Those messages are written in the logbook. The logbook cannot be displayed by the IO-Link master. Please use the software Bürkert Communicator Type 8920 to read the logbook (see chapter 14.4).

To handle those messages, please refer to the corresponding chapter in büS (chapter 19).



If the message displayed on your product is not explained in the Operating Instructions, contact Bürkert.

Detailed view of the **Observation** menu:

Setting	
Events. Sensor connection error	<ul style="list-style-type: none">• Inactive• Active
Events. Factory data error	<ul style="list-style-type: none">• Inactive• Active
Events. Temperature sensor error	<ul style="list-style-type: none">• Inactive• Active
Events. Measurement saturation error	<ul style="list-style-type: none">• Inactive• Active

8.5.5. Diagnostic

The **Diagnostic** menu provides access to the following functionalities:

- Cell working time
- Sensor information
- Calibration limits
- Device status

All those submenus provide access to several categories of read-only values.

For more information on this menu, please refer to the corresponding chapter in büS (chapter [11](#)).

Detailed view of the **Diagnostic** menu:

Parameter	
Sensor parameters. Cell working time	
Sensor information	pH/ORP sensor variables. Hardware version
	pH/ORP sensor variables. Serial number
	pH/ORP sensor variables. Firmware version
	pH/ORP sensor variables. Manufacture date

Parameter	
Calibration limits: Offset limits	Limits. Error high
	Limits. Error low
	Limits. Warning high
	Limits. Warning low
Calibration limits: Slope limits	Limits. Error high
	Limits. Error low
	Limits. Warning high
	Limits. Warning low
Device status	Status. Device status
	Status. Device temperature
	Status. Supply voltage
	Status. Operating duration
	Status. Max. temperature
	Status. Min. temperature
	Status. Max. supply voltage
	Status. Min. supply voltage
	Status. Calibration required
	Status. Device current
	Status. Maximum device current

Parameter	
	Status. Minimum device current
	Status. Device boot counter
	Status. Transferable memory status
	Status. Voltage drop counter
	Status. Operating period since last boot

9. SETTING AND OPERATION IN BÜS

9.1. Safety instructions



DANGER

Risk of injury from electric shocks.

- Before working on the installation or product, switch off the power supply. Make sure that nobody can switch the power supply on.
- Observe all applicable accident protection and all applicable safety regulations for electrical equipment.

NOTICE

Risk of injury from improper operation.

Improper operation can lead to injuries and damage to the product and its environment.

- Before commissioning, make sure that the operating personnel are familiar with, and fully understand the content of the Operating Instructions.
- Observe the safety information and the intended use.
- Only properly trained personnel may commission the installation and the product.
- Only properly trained personnel may change parameters with the help of the Bürkert software for display Type ME21, the EDIP process display Type ME61 or the software Bürkert Communicator Type 8920.

9.2. Setting tools and setting software

The settings can be made with the following tools:

- a PC with the software Bürkert Communicator Type 8920 and the büS stick. To get general information about the Type 8920 software, refer to the Operating Instructions of the Type 8920.

The calibration functions of the device can be made with a 7" Process Control Display Type ME61. For more information about the calibration function with Type ME61, refer to chapter 16). For more information about the Type ME61, refer to the Operating Instructions of the Type ME61.

9.3. Description of the user interface

The Operating Instructions of the product describe the following elements of the user interface:

- the user levels. Refer to chapter 9.4.
- the product functions. Each function has 3 menus. Refer to chapter 9.5.
- the **Logbook**, overview of the messages that are related to the product. Refer to chapter 14.4.

9.4. Available login user levels

The following 4 login user levels are available:





- the basic user level, which is the level with the least functions,
- the **Advanced User** user level,
- the **Installer** user level,

- the **Bürkert** user level.

By default, the product adjustment is protected by passwords.

Table 1 shows the symbol displayed in the information bar, depending on the user level that is active on the product, and what can be done with each type of user level.

Table 1: Possible login user levels

Symbol	User level	Description
	Basic user	<ul style="list-style-type: none"> • No password is required. • This level is active by default (and by default, password protection is switched off). • The menu items with the symbol  enable read-only access. • Not all the menu items that are available with a higher user level are displayed.
	Advanced user	<ul style="list-style-type: none"> • Password required, if the password protection is active. Default password is 5678. • The menu items with the symbol  enable read-only access. • Not all the menu items that are available with a higher user level are displayed.
	Installer	<ul style="list-style-type: none"> • Password required, if the password protection is active. Default password is 1946. • All the available menu items can be adjusted.

Type 8202 ELEMENT neutrino

Sensor – Parameter

Symbol	User level	Description
	Bürkert	<ul style="list-style-type: none"> • Password required, if the password protection is active. • Only for Bürkert service.

→ For further information, refer to the Operating Instructions of the Type 8920.

9.5. Product functions and menus

The product has 2 functions and each function has 3 menus.

→ To access the product functions and the menus, refer to the Operating Instructions of the Type 8920.

The functions and menus are described in the following chapters:

- Function **Sensor**, menu **Parameter** in chapter 10.
- Function **Sensor**, menu **Diagnostics** in chapter 11.
- Function **Sensor**, menu **Maintenance** in chapter 12.
- Function **General setting**, menu **Parameter** in chapter 13.
- Function **General setting**, menu **Diagnostics** in chapter 14.
- Function **General setting**, menu **Maintenance** in chapter 15.

10. **SENSOR** – **PARAMETER**

→ Select **Sensor 8202**.

→ Go to **Sensor** -----> **Parameter**.

Detailed view of the menu:

Setting		
Sensor		
	ORP	
	pH	
Measurement type		
	Symmetrical	
	Asymmetrical	
Mains frequency		
	50 Hz	
	60 Hz	
Measure values	Configure filter response time and limits	
	pH	Only for pH type
	ORP	Only for ORP type
	Temperature	
	Voltage	Only for pH type
	Reference impedance	
	Glass impedance	Only for pH type

Setting	
Events	Enable / disable events notification
	Sensor connection lost
	Factory data failure
	Temperature failure
	Measurement saturation
Reset to factory	

The menu items are detailed in the following chapters:

- Sensor type, refer to chapter [10.1.1](#).
- Measurement type, refer to chapter [10.1.2](#).
- Mains frequency, refer to chapter [10.1.3](#).
- Measure values, refer to chapter [10.2](#).
- Events, refer to chapter [10.3](#).
- Reset to factory, refer to chapter [10.4](#).

10.1. Setting sensor parameters

It is possible to set:

- Sensor type
- Measurement type
- Mains frequency

10.1.1. Sensor

→ To set the type of sensor, go to **Sensor** -----> **Parameter**
-----> **Sensor**.

→ Select the type of sensor between **pH** and **ORP**.

10.1.2. Measurement type

Symmetrical measurement

The symmetrical measurement is a differential measurement: In this type of measurement, the stainless steel ring on the sensor holder is used as a reference.

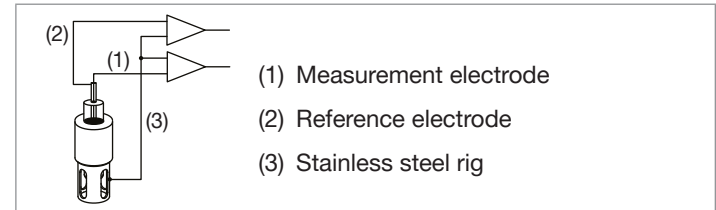

Fig. 14: Schematic diagram of symmetrical measurement

Asymmetrical measurement

In the asymmetrical measurement, the measurement is done in relation to the reference electrode.

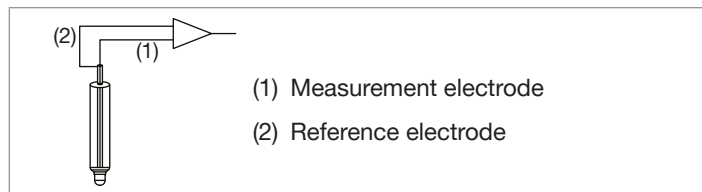

Fig. 15: Schematic diagram of asymmetrical measurement

- To set the measurement type, go to **Sensor** -----> **Parameter** -----> **Measurement type**.
- Select the measurement type between **Symmetrical** and **Asymmetrical**.

10.1.3. Mains frequency

This parameter is used to select the frequency of your mains electricity, 50 Hz or 60 Hz. This frequency is filtered by the device to ensure stable measurements.

- To set the mains frequency, go to **Sensor** -----> **Parameter** -----> **Mains frequency**.
- Select the mains frequency between **50 Hz** and **60 Hz**.

10.2. Setting parameter for each measured values

Measured value by the 8202 are:

- pH
- ORP
- Temperature
- Voltage
- Reference impedance
- Glass impedance

The menu **Measure values** allows to set the following parameters for each measured value:

- Filter response time
- Limits

10.2.1. Set the filter response time of a measured value

The filter makes it possible to filter the fluctuations of the measured values. Response time (in seconds) can be set by user for each measured value.

- Go to **Parameter** -----> **Measure values**.
- Select the measured value you want to configure.
- Go to **Filter response time**.
- Write the number of seconds of the response time.

10.2.2. Activating the monitoring of measured values

Because of a malfunction in the process or in the sensor, the measured values can be too high or too low.

A monitored value can be:

- in the normal operating range.
- in the warning range,
- in the error range.

You can set 4 limit values: 2 error limits and 2 warning limits.

→ To set the limit values, see chapter [10.2.4](#).

[Fig. 16](#) explains how the device reacts when the monitored value enters in another range (for example, from the normal range into the warning range). The reaction time depends on the hysteresis value and whether the monitored value increases or decreases.

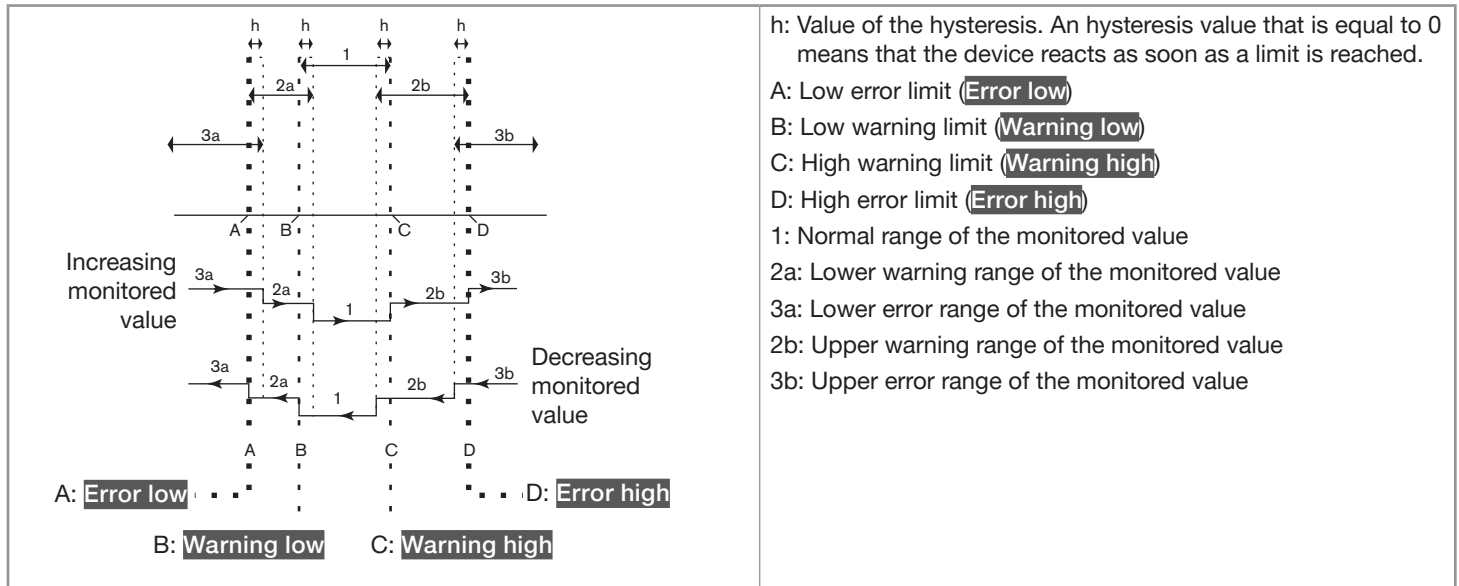

Fig. 16: Operating principle of the monitoring with an hysteresis

Monitored value is in the	Colour of the device status indicator and generated message	Condition
Error range	Red ¹⁾ indicator, Failure message	<ul style="list-style-type: none"> if the monitored value was in the LOWER warning range and the LOW ERROR value is reached. if the monitored value was in the UPPER warning range and the HIGH ERROR value is reached.
Warning range	Yellow ¹⁾ indicator, Out of specification message	<ul style="list-style-type: none"> if the monitored value was in the LOWER error range and the LOW ERROR value + the HYSTERESIS value is reached. if the monitored value was in the normal range and the HIGH WARNING value is reached. if the monitored value was in the UPPER error range and the HIGH ERROR value minus the HYSTERESIS value is reached. if the monitored value was in the normal range and the LOW WARNING value is reached.
Normal range	<ul style="list-style-type: none"> White ¹⁾ indicator, no message, if the Diagnostics in the menu General settings – Parameter are inactive. or green ¹⁾ indicator, no message, if the Diagnostics in the menu General settings – DIAGNOSTICS are active. 	<ul style="list-style-type: none"> if the monitored value was in the LOWER warning range and the LOW WARNING value + the HYSTERESIS value is reached. if the monitored value was in the UPPER WARNING range and the HIGH WARNING value minus the HYSTERESIS value is reached.

¹⁾ If the operating mode of the device status indicator is set to NAMUR. See chapter [17.2](#).

By default, the monitoring of measured values is disabled, and the diagnostics are all enabled. To activate the monitoring of one of the measured values, do the following:

→ Go to **Sensor** -----> **Parameter** -----> **Measure values** -----> [Name of the value you want to monitor] -----> **Limits** -----> **Active**.

→ Set value to **Active**.

10.2.3. Deactivating the monitoring of measured values

By default, the measured values are not monitored.

But if the monitoring of one of the measured values is active, do the following to deactivate it:

- Go to **Sensor** -----> **Parameter** -----> **Measure values**
-----> [Name of the value you want to monitor] ----->
Limits -----> **Active**.
- Set value to **Inactive**.

10.2.4. Changing the error limits, the warning limits and the hysteresis of the measured values

To change the error limits, the warning limits and the hysteresis of the measured value, do the following:

- Go to **Sensor** -----> **Parameter** -----> **Measure values**
-----> [Name of the value you want to change] ----->
Limits -----> **Settings**.
- The **Current settings** are displayed.
- Set the high error limit.
- Set the low error limit.
- Set the high warning limit.
- Set the low warning limit.
- Set the hysteresis value.

→ The **New settings** are displayed.

✓ The limit values and the hysteresis value are changed.

10.2.5. Activate display of reference impedance and glass impedance

By default, reference impedance and glass impedance are not displayed as process values. To activate one of these measurements, do the following:

- Go to **Sensor** -----> **Parameter** -----> **Measure values**
-----> [Name of the process] -----> **Measurement**.
- Set value to **Active**.

Table 2: Possible combinations of electrode monitoring depending on the measurement mode, symmetrical or asymmetrical

Measurement mode (see chapter 10.1.2)	Monitoring of the impedance			
	pH probe		Redox ("ORB") probe	
	Glass electrode	Reference electrode	Glass electrode	Reference electrode
Symmetrical	Possible	Possible	Impossible	Possible
Asymmetrical	Possible	Impossible	Impossible	Impossible

10.2.6. Deactivate display of reference impedance and glass impedance

By default, reference impedance and glass impedance are not displayed as process values. If it has been activated, do the following to deactivate one of these measurements:

- Go to **Sensor** -----> **Parameter** -----> **Measure values** -----> [Name of the process] -----> **Measurement**.
- Set value to **Inactive**.

10.3. Configure reaction of the device to specific events

The device detects events that can have an impact on the trueness of the values measured by the sensor.

- Event Sensor connection lost
- Event Factory data failure
- Temperature sensor failure
- Measurement saturation

More details concerning what causes the event and how to handle it are given in chapter [19](#).

The device gives the possibility for the customer to activate or deactivate the monitoring of each of these events.

10.3.1. Activating the monitoring of an event

By default, the monitoring of events is enabled, and the diagnostics are all enabled. But if the monitoring of one of the events is inactive, do the following to activate it:

- Go to **Sensor** -----> **Parameter** -----> **Events** -----> [Name of the value you want to monitor].
- Set value to **Active**.

10.3.2. Deactivating the monitoring of an event

By default, the events are monitored.

Do the following to deactivate it:

- Go to **Sensor** -----> **Parameter** -----> **Events** -----> [Name of the value you want to monitor].
- Set value to **Inactive**.

10.4. Resetting to factory default parameter data

See chapter 10 to access the **Parameters** menu. The following data can be restored to their default values:

- Sensor
- Measurement type
- Mains frequency
- Temperature limits & filter response time
- ORP limits & filter response time
- pH limits & filter response time
- Voltage limits & filter response time
- Reference impedance limits & filter response time & activation / deactivation
- Glass impedance limits & filter response time & activation / deactivation
- Events

→ Go to **Sensor** -----> **Parameter** -----> **Reset to factory**.
→ Confirm.

11. SENSOR – DIAGNOSTICS

→ Select **Sensor 8202**.
→ Go to **Sensor** -----> **Diagnostics**.

The menu shows several categories of read only values.

- Sensor information
- Calibration limits
- Measure values
- Cell working time

Detailed view of the menu:

Setting		
Sensor information	Read sensor information	
	Hardware version	
	Serial number	
	Firmware version	
	Manufacture date	
Calibration limits	Read calibration limits	
	Offset limits	Read accepted values for the offset parameter
	Slope limits	Read accepted values for the slope parameter

Setting	
Measure values	Read measure values
	pH
	ORP
	Temperature
	Voltage
	Reference impedance
	Glass impedance
Cell working time	Time since the cell has been powered

12. SENSOR – MAINTENANCE

→ Select **Sensor 8202**.

→ Go to **Sensor** -----> **Maintenance**.

The menu shows the following sub menu:

- **Simulation**
- **Calibration**
- **Calibration schedule**
- **Reset to factory**

Setting		
Simulation	Simulate values on process values	
	pH	
	ORP	
	Temperature	
	Voltage	
	Reference impedance	
	Glass impedance	
Calibration	Configure calibration coefficients	
	Calibration temperature	
	1 point	
	2 point	Only for pH type
	Offset	
	Slope	Only for pH type
	Temperature offset	

Setting		
Calibration schedule	Configure calibration frequency reminders	
	Interval in days	Configure numbers of days between two calibrations
	Last calibration	Read the date of the last successful calibration
	Next calibration	Read next calibration date
Reset to factory		

12.1. Checking the output behaviour

The feature allows for simulating the measurement of the process value to check if the outputs are correctly configured.

- Go to **Sensor** -----> **Maintenance** -----> **Simulation** -----> **Process value**.
- Select the process values to be tested between **pH**, **ORP**, **Temperature**, **Voltage**, **Reference impedance**, **Glass impedance**.
- The possibility to write values on the selected values appears.
- Write the constant values to simulate in the menu **Sensor** -----> **Maintenance** -----> **Simulation**.

12.2. Calibration of the pH sensor

12.2.1. Calibration temperature

To calibrate the pH sensor, do the following:

- Go to **Sensor** -----> **Maintenance** -----> **Calibration** -----> **Calibration temperature**.
- Choose the type of temperature compensation for the calibration process:
 - either the temperature measured: select **process**,
 - or a fixed value: select **constant**, then enter the reference temperature.

12.2.2. Calibration PH sensor

Calibrate the pH sensor in 1 or 2 points (see details hereafter). A calibration process updates the last calibration date.

- **1-point calibration:** The 1-point calibration procedure is used for quick calibration by adjusting the offset of the measurement graph with a buffer respectively a calibration solution with a known pH.
- **2-point calibration:** The 2-point calibration procedure is used for the precise calibration of the offset and the gradient (slope) of the sensor measurement graph. This operation requires 2 buffer solutions: in general a first solution with a pH of 7 and a second solution with a pH very close to the expected value to be measured in the process.

1-point calibration for pH sensor

→ To calibrate the pH sensor, go to **Sensor** -----> **Maintenance** -----> **Calibration** -----> **1 point**.



- Before each calibration, correctly clean the electrode with a suitable product.
- Set the periodicity of calibrations in the **Interval in days** function in the sub-menu **Calibration schedule**: each time a calibration is due, the device generates a "maintenance" event.

Follow the calibration procedure hereafter:

Step 1/5:

→ Immerse the clean sensor in the buffer solution; the device displays: the measured pH and the measured temperature of the solution.

→ Select **Next**.

Step 2/5:

→ Enter the pH of the buffer solution: select **Next**.

Step 3/5:

→ When the pH measurement is stable: select **Next**.

Step 4/5:

There are 3 possible results:

- The calibration succeeds.
- The message **Error: Value out of range** is displayed.
- The message **Warning: Value out of range** is displayed.

2 options are possible:

- Accept the new offset value. Select **Next** and go to step 5/5.
- Reject the new offset value. Select **Cancel** and restart calibration.

Step 5/5:

The calibration is completed.

→ Select **Finish**.



The new offset value is displayed.



The date of the last calibration is updated. See chapter [12.3](#).

2-point calibration for pH sensor

→ To calibrate the pH sensor, go to **Sensor** -----> **Maintenance** -----> **Calibration** -----> **2 point**.



- Before each calibration, correctly clean the electrode with a suitable product.
- In a 2-point calibration, the buffer solutions used must be at the same temperature.
- Set the periodicity of calibrations in the **Interval in days** function in the sub-menu **Calibration schedule**: each time a calibration is due, the device generates a "maintenance" event.

Type 8202 ELEMENT neutrino

Sensor – Maintenance

Follow the calibration procedure hereafter:

Step 1/9:

- Immerse the clean sensor in first the buffer solution; the device displays: the measured pH and the measured temperature of the solution.
- Select **Next**.

Step 2/9:

- Enter the pH of the buffer solution.
- Select **Next**.

Step 3/9:

- When the pH measurement is stable: select **Next**.

Step 4/9:

- Rinse the sensor.
- When the pH reaches the desired value, validate rinsing with **Next**.

Step 5/9:

- Immerse the clean sensor in the second buffer solution; the device displays: the measured pH and the measured temperature of the solution.
- Select **Next**.

Step 6/9:

- Enter the pH of the buffer solution.
- Select **Next**.

Step 7/9:

- When the pH measurement is stable: select **Next**.

Step 8/9:

There are 3 possible results:

- The calibration succeeds.
- The message **Error: Value out of range** is displayed.
- The message **Warning: Value out of range** is displayed.

2 options are possible:

- Accept the new offset value. Select **Next** and go to step 9/9.
- Reject the new offset value. Select **Cancel** and restart calibration.

Step 9/9:

The calibration is completed.

- Select **Finish**.

- ✓ The new offset value is displayed.
- ✓ The date of the last calibration is updated. See chapter [12.3](#).

At the end of the calibration of the pH sensor, two types of message may be displayed: see [Table 3, page 50](#).

Table 3: Warning and error messages during pH sensor calibration

Message	"slope" value	"offset" value	Possible cause	Recommended action
Warning: Slope/offset out of range	-50 mV/pH > slope > -53 mV/pH or -63 mV/pH > slope > -65 mV/pH	-60 mV < Offset < -35 mV or 35 mV < Offset < 60 mV	Error in the buffer solution	→ Use the correct buffer solution.
			The probe has reached halfway in its lifespan.	→ The values can be saved or not.
Error: Slope/offset out of range	> -50 mV/pH or < -65 mV/pH	< -60 mV or > 60 mV	The probe must be replaced.	→ Replace the probe. → Calibrate the device again when the new probe is in place.

Table 4: Warning and error messages when calibrating an oxidation reduction potential ("ORP") probe

Message	"offset" value	Possible cause	Recommended action
Warning: Offset out of range	-60 mV < Offset < -35 mV or 35 mV < Offset < 60 mV	Error in the buffer solution	→ Use the correct buffer solution.
		The probe has reached halfway in its lifespan.	→ The values can be saved or not.
Error: Offset out of range	< -60 mV or > 60 mV	The probe must be replaced.	→ Replace the probe. → Calibrate the device again when the new probe is in place.

12.2.3. Calibration Redox ("ORP") sensor

→ To calibrate the Redox sensor, go to **Sensor** -----> **Maintenance** -----> **Calibration** -----> **1 point**.



- Before each calibration, correctly clean the electrode with a suitable product.
- Set the periodicity of calibrations in the **Interval in days** function in the sub-menu **Calibration schedule**: each time a calibration is due, the device generates a "maintenance" event.

Follow the calibration procedure hereafter:

Step 1/5:

→ Immerse the clean sensor in the buffer solution; the device displays: the measured potential and the measured temperature of the solution.

→ Select **Next**.

Step 2/5:

→ Enter the potential of the reference solution (indicated on the bottle).

→ Select **Next**.

Step 3/5:

→ When the potential measurement is stable: select **Next**.

Step 4/5:

There are 3 possible results:

- The calibration succeeds.
- The message **Error: Value out of range** is displayed.
- The message **Warning: Value out of range** is displayed.

2 options are possible:

- Accept the new offset value. Select **Next** and go to step 5/5.
- Reject the new offset value. Select **Cancel** and restart calibration.

Step 5/5:

The calibration is completed.

→ Select **Finish**.

- ✓ The new offset value is displayed.
- ✓ The date of the last calibration is updated. See chapter [12.3](#).

At the end of the calibration of the oxidation reduction potential ("ORP"), two types of message may be displayed: see [Table 4, page 50](#).

12.2.4. Offset / Slope

Enter the offset and/or slope values indicated on the pH/ORP sensor certificate, if supplied. This input replaces a calibration made by the **Calibration** function above but does not update the last calibration date of the Calibration schedule from the sub-menu hereafter.

→ To read or enter the offset, go to **Calibration** -----> **Offset**.

→ To read or enter the slope, go to **Calibration** -----> **Slope**.

12.2.5. Setting temperature offset

To read or enter the temperature offset, go to **Calibration** -----> **Temperature Offset**.

12.3. Configure calibration schedule

The calibration schedule menu gives access to several data:

- **Last calibration**: Gives the date of the last calibration made by the device. This value is updated automatically when a calibration wizard is done successfully.
- **Interval in days**: This value is configurable. When the interval value is 0, the function is deactivated.
- **Next calibration**: Last calibration + Interval in days. When the date of next calibration is reached, the device generates a "maintenance" event and a message.

To access these values, go to **Sensor** -----> **Maintenance** -----> **Calibration schedule**.

12.4. Resetting calibration data to factory default value

See chapter 10 to access the **Parameters** menu. The following data can be restored to their default values:

- Calibration temperature
- Offset
- Slope
- Temperature offset
- Last calibration date
- Next calibration date
- Interval in days

→ To reset these parameters to factory default, go to **Sensor** -----> **Maintenance** -----> **Reset to factory**.

→ Confirm.

13. GENERAL SETTINGS – PARAMETER

→ Select **Sensor 8202**.

→ Go to **General settings** -----> **Parameter**.

Detailed view of the menu:

Setting	
Status LED	Configure color and behavior of the device status LED
	NAMUR mode
	Fixed color
	Demo mode
	LED off
büS	Configure büS interface
	Displayed name
	Location
	Description
	Advanced
Alarm limits	Limits for warning and errors to be sent
	Supply voltage
	Device temperature
Diagnostics	Activate / Deactivate diagnostics
PDO configuration	Configuration of the cyclic process data objects

13.1. Changing the operating mode of the device status indicator or switching off the device status indicator

By default, the device status indicator operates according to the NAMUR NE 107 standard (**NAMUR mode**).

The following other operating modes of the device status indicator are available:

- **Fixed color**: choose the permanent colour of the device status indicator.
- **LED off**: the device status indicator is always off.
- **Demo mode**: the LED of the device shows all NAMUR colours successively for 5 s.

13.1.1. Changing the operating mode of the device status indicator

To change the operating mode of the device status indicator, do the following:

→ Go to **General settings** -----> **Parameter** -----> **Status LED** -----> **Mode**.

→ Choose the operating mode of the device status indicator.

✓ The operating mode of the device status indicator is changed.

13.1.2. Switching off the device status indicator

To switch off the device status indicator, do the following:

→ Go to **General settings** -----> **Parameter** -----> **Status LED** -----> **Mode**.

→ Select **LED off**.

✓ The device status indicator is always off.

13.2. Setting the basic parameters for identifying the device on bÜS

The **Displayed name**, the **Location** and the **Description** allow you to clearly identify the device on bÜS.

13.2.1. Entering a name for the device

The entered name will be shown on any display (e.g. the software Bürkert Communicator Type 8920) connected to bÜS.

To enter the name of the device that will be shown on any display connected to bÜS, do the following:

→ Go to **General settings** -----> **Parameter** -----> **bÜS** -----> **Displayed name**.

→ Enter the name by selecting and confirming each character.

✓ The name is set.

13.2.2. Entering the location of the device

The entered location will be shown on any display (e.g. the software Bürkert Communicator Type 8920) connected to bÜS.

To enter the information where the device is geographically located, do the following:

→ Go to **General settings** -----> **Parameter** -----> **bÜS** -----> **Location**.

→ Enter the location by selecting and confirming each character.

✓ The location is set.

13.2.3. Entering a description for the device

The description allows you to precisely identify this device. To enter a description for the device, do the following:

→ Go to **General settings** -----> **Parameter** -----> **bÜS** -----> **Description**.

→ Enter the description (max. 19 characters) by selecting and confirming each character.

✓ The description is set.

13.3. Setting the advanced parameters for identifying the device connected to bÜS or to a CANopen bus

13.3.1. Entering a unique name for the device



- Only change the **Unique device name** of a device if 2 devices with the same name are connected to bÜS or to a CANopen bus.
- If the **Unique device name** of the device is changed, the participants on bÜS or to a CANopen bus lose the link to the device. The link between the participants must then be restored.

The **Unique device name** of the device is used by the participants connected to bÜS or to a CANopen bus. To change the **Unique device name**, do the following:

- Go to **General settings** -----> **Parameter** -----> **bÜS**
-----> **Advanced** -----> **Unique device name**.
- Enter the name by selecting and confirming each character.
- ✓ The unique name is set.

13.3.2. Changing the transmission speed on the device

The transmission speed for the communication on the fieldbus (both bÜS or CANopen) must be the same for all the participants of the fieldbus.

By default, the transmission speed of the device is 500 kbit/s. This transmission speed is suited for a maximum cable length of 50 m.

If the cable length is higher, reduce the transmission speed of all the participants.

To change the transmission speed of the device, do the following:

→ Go to **General settings** -----> **Parameter** -----> **bÜS**
-----> **Advanced** -----> **Baudrate**.

→ Choose the transmission speed.

- ✓ The transmission speed of the device is changed. To take the transmission speed into account, restart the device.

13.3.3. Changing the address of the device connected to a CANopen bus

The address of the device is used by bÜS or the CANopen fieldbus the device can be connected to.

- If the device is connected to bÜS, bÜS automatically addresses the device. By default, the address of the device on bÜS is 30.
 - If the device is connected to a CANopen fieldbus, the addresses are not set automatically.
- Make sure that each participant, including the device, connected to the CANopen fieldbus has a specific address.

If the device is connected to a CANopen fieldbus and another participant connected to the fieldbus has the same address, do the following to change the address of the device:

→ Go to **General settings** -----> **Parameter** -----> **bÜS**
-----> **Advanced** -----> **bÜS address**.

→ Change the address of the device. Make sure you enter an address that is not already used on the same CANopen fieldbus.

✓ The address of the device is changed.

→ Start the device to take the new address into account.

13.3.4. Setting the digital communication for bÜS or for a CANopen bus

By default, the operating mode of the digital communication is set to **bÜS** and the measured process data (PDOs, process data objects) are sent on a connected fieldbus.

The other operating modes of the digital communication are **Standalone** or **CANopen**.

If the device is connected to Standalone or to a CANopen bus, do the following to change the operating mode of the digital communication:

→ Go to **General settings** -----> **Parameter** -----> **bÜS**
-----> **Advanced** -----> **Bus mode**.

→ Choose **bÜS** or **CANopen**.

→ Restart the device.

✓ The operating mode of the digital communication is bÜS or CANopen.

✓ If the operating mode of the digital communication is bÜS, the **CANopen status** is set to **Operational** (see chapter 14.2) and the PDOs are sent to bÜS.

✓ If the operating mode of the digital communication is CANopen, the **CANopen status** is set to **Pre-op** (see chapter 14.2) until the CANopen network master switches the device to **Operational**.

→ To stop the PDOs being sent to bÜS or to a fieldbus, see chapter 13.3.5.

13.3.5. Stop sending the measured process data (PDOs) to bÜS or to the CANopen fieldbus

If the device is connected to bÜS or to a CANopen fieldbus and the **Bus mode** is set to **bÜS** or to **CANopen** and you want to temporarily stop sending the PDOs to bÜS or to the CANopen fieldbus, do the following:

→ Go to **General settings** -----> **Parameter** -----> **bÜS**
 -----> **Advanced** -----> **Bus mode.**

→ Select **Standalone.**

→ Restart the device.

✓ The **CANopen status** is set to **Pre-op** and the PDOs are not sent to bÜS or to a CANopen fieldbus.

✓ The communication with the software Bürkert Communicator Type 8920 is still operational.

→ To enable the transmission of the PDOs to bÜS or to a fieldbus, see chapter [13.3.4](#).

13.4. Monitoring the supply voltage or the device temperature

The supply voltage of the device and the internal temperature of the device are monitored.

A monitored value can be:

- in the normal operating range,
- in the warning range,
- in the error range.

4 limit values are set, 2 error limits and 2 warning limits. The error limits can only be read but the warning limits can be adjusted.

[Fig. 16, page 41](#) explains how the device reacts when the monitored value enters into another range (for example, from the normal range into the warning range). The reaction time depends on the hysteresis value and on whether the monitored value increases or decreases.

13.4.1. Reading out the 2 error limit values

To read out the limits the supply voltage of the device should be in, do the following:

→ Go to **General settings** -----> **Parameter** -----> **Alarm limits.**

→ Choose **Supply voltage** or **Device temperature.**

→ Choose **Error high** or **Error low.**

13.4.2. Changing the 2 warning limit values

To change the warning limits of the supply voltage or of the device temperature, do the following:

- Go to **General settings** -----> **Parameter** -----> **Alarm limits**.
- Choose **Supply voltage** or **Device temperature**.
- Choose **Warning high** or **Warning low**.
- Set the warning limit.

✓ The warning limits are changed.

13.4.3. Reading out the hysteresis value

To read out the hysteresis value, do the following:

- Go to **General settings** -----> **Parameter** -----> **Alarm limits**.
- Choose **Supply voltage** or **Device temperature**.
- Select **Hysteresis**.

13.5. Activating the diagnostics function



WARNING

Risk of injury due to non-conforming adjustment.

Non-conforming adjustment could lead to injuries and damage the device and its surroundings.

- ▶ The operators in charge of adjustment must have read and understood the contents of the Operating Instructions.
- ▶ In particular, observe the safety recommendations and intended use.
- ▶ The device/installation must only be adjusted by suitably trained staff.

By default, all the diagnostics events related to the process, the electronics or the sensor, the messages related to the monitoring of the process values (e.g. the conductivity) and the messages related to problems on the device and on bÜS are enabled.

If the diagnostics are inactive on the device, do the following to enable them:

- Activate the monitoring of the process values that must be monitored. See chapter 10.2.2, chapter 10.3.1.
- Go to **General settings** -----> **Parameter** -----> **Diagnostics**.
- Read the displayed message.
- Select **Active**.
- Restart the device.

✓ The needed diagnostics are active.

13.6. Disabling all the diagnostics

By default, all the diagnostics events related to the process, the electronics or the sensor, the messages related to the monitoring of the process values (e.g. the flow rate) and the messages related to problems on the device and on bus are enabled.

To disable the diagnostics, do the following:

- Go to **General settings** -----> **Parameter** -----> **Diagnostics**.
- Read the displayed message.
- Select **Inactive**.
- Restart the device.
- ✓ All the diagnostics are disabled.

13.7. PDOs configuration

13.7.1. Set the transmission time between 2 values of a PDO

The process data objects (PDO) are cyclic data sent from the product to the other participants of the fieldbus or received by the product from other participants to the fieldbus.

The transmission time between 2 values of a PDO is described by the 2 following parameters:

- the value of the parameter **Event timer** is the time after which the product sends the value of the same PDO, even if the value did not change. It enables a periodical transmission of the PDO.
- the value of the parameter **Inhibit time** is the minimum time between the sending of 2 different PDOs.

13.7.2. Restore all PDOs to their default values

Make sure that the login user level is **Installer**. Refer to chapter [9.4](#).

- Go to **General settings** -----> **Parameter**.
- Select **PDO configuration**.
- Select **Reset to default values**.
- ✓ The PDOs are set to their default values.

14. GENERAL SETTINGS – DIAGNOSTICS

→ Select **Sensor 8202**.

→ Go to **General settings** -----> **Diagnostics**.

Setting	
Device status	Read device status information
	Operating duration
	Operating period since last reboot
	Device temperature
	Supply voltage
	Current consumption
	Voltage drops
	Min/Max values
	Device boot counter
	Transferable memory
	Current system time
büS status	Read büS status information
	Receive errors
	Receive errors max
	Transmit errors
	Transmit errors max
	Reset errors counter
	CANopen status
Logbook	Read book of events

14.1. Reading out device status information

The device allows to read out the following device status information:

- **Operating duration**: time in s since first power up of the device.
- **Operating period since last reboot**: time in s since last reboot of the device.
- **Device temperature**: temperature measured by the device.
- **Supply voltage**: current supply voltage.
- **Current consumption**: current consumption of the device in A.
- **Voltage drops**: count of voltage drops since last reboot.
- **Min/Max values**: minimum and maximum values of temperature and supply voltage measured by the device.
- **Device boot counter**: number of reboot made by the device.
- **Transferable memory status**: signal if a device to which the memory could be transferred is available on the device.
- **Current system time**: current date.

14.2. Reading out bÜS status information

The device allows to read the following bÜS status information:

- **Receive errors:** Number of receive errors
- **Receive errors max:** Maximum number of receive errors since last reset of the max error counters
- **Transmit errors:** Number of transmit errors
- **Transmit errors max:** Maximum number of transmit errors since last reset of the max error counters
- **CANopen status:**
 - If the CANopen status is **Operational**, the PDOs are sent to bÜS.
 - If the CANopen status is **Pre-op** (pre-operational), the PDOs are not sent on bÜS or on the CANopen fieldbus and a message is generated in the message list. For example, the Pre-op status is active if the Bus mode is set to **Standalone** (see chapter [13.3.4](#)).

14.3. Resetting errors counter

By running the wizard reset errors counter, the device resets maximum number of receive errors and maximum number of transmit errors.

14.4. Read the generated events

To read the events that are related to the product, do the following procedure:

→ Go to **General settings** -----> **Diagnostics**.







→ Select **Logbook**.

The events that are related to the product are displayed.

The events are displayed on the screen.

[Table 5](#) shows the existing types of events and the symbols associated to the types.

Table 5: Description of the symbols

Symbol	Status	Description
	Failure, error or fault	Malfunction
	Function check	Ongoing work on the product. For example, simulating measurement values.
	Out of specification	At least one of the monitored parameters is outside its monitored limits.
	Maintenance required	The product is in controlled operation; however, the function is briefly restricted. → Do the required maintenance operation.
	Diagnostics active and no event has been generated	Status changes are shown in colour. Messages are listed and possibly transmitted through any connected fieldbus.
	Diagnostics inactive	Status changes are not shown. Messages are neither listed nor transmitted through any connected fieldbus.

Detailed description of the events stored in logbook and how to handle them is described in chapter [19](#).

15. GENERAL SETTINGS – MAINTENANCE

- Select **Sensor 8202**.
- Go to **General settings** -----> **Maintenance**.
- Select **Device information**. The menu shows only read-only values. **Table 6** shows the values.

Table 6: Description of the parameters

Parameter	Description	
Ident. number	Product article-number	
Serial number	Product serial-number	
Firmware ident. number	Article number of the product software	
Firmware version	Version number of the product software	
büS version	büS version-number	
Hardware version	Version number of the product hardware	
Product type	Type of the product	
Manufacture date	Product manufacturing-date	
eds version	EDS version-number	
Device driver	Driver version	Version number of the product driver
	Firmware group	Product name and EDS version-number
	Origin	Path to the driver file

15.1. Restart product

- Make sure that the login user level is **Installer**. Refer to chapter **9.4**.
- Go to **General settings** -----> **Maintenance**.
- Select **Reset device** -----> **Restart**.
- To cancel the procedure, select **Cancel**.
- To restart the product, select **Next**.

✔ The product restarts.

15.2. Reset the product to its factory settings

To reset the product to all its factory settings, do the following procedure:

- Make sure that the login user level is **Installer**. Refer to chapter **9.4**.
- Go to **General settings** -----> **Maintenance**.
- Select **Reset device** -----> **Reset to factory settings**.
- To cancel the procedure, select **Cancel**.
- To reset the product to its factory settings, select **Next**.

✔ The product restarts and the product is reset to all its factory settings.

Type 8202 ELEMENT neutrino

Calibrate the device with a 7" process Control display Type ME61

16. CALIBRATE THE DEVICE WITH A 7" PROCESS CONTROL DISPLAY TYPE ME61

16.1. Safety instructions



DANGER

Risk of injury from electric shocks.

- Before working on the installation or product, switch off the power supply. Make sure that nobody can switch the power supply on.
- Observe all applicable accident protection and all applicable safety regulations for electrical equipment.

NOTICE

Risk of injury from improper operation.

Improper operation can lead to injuries and damage to the product and its environment.

- Before commissioning, make sure that the operating personnel are familiar with, and fully understand the content of the Operating Instructions.
- Observe the safety information and the intended use.
- Only properly trained personnel may commission the installation and the product.

NOTICE

Risk of injury from improper operation.

Improper operation can lead to injuries and damage to the product and its environment.

- Only properly trained personnel may change parameters with the help of the Bürkert 7" Process Control Display Type ME61 or the software Bürkert Communicator Type 8920.

16.2. Parametrizing the calibration function

The adjustment of the product can be made:

- either with the 7" Process Control Display Type ME61, communicating with the device with a bÜS (Bürkert bus) cable,
- or with a PC and the software Bürkert Communicator Type 8920. To get general information about the software Type 8920, refer to the Operating Instructions of the Type 8920.

The calibration functionality cannot be handled with the 3" Process View Display Type ME61.

16.2.1. Preparation for defining the calibration action on the 7" Process Control Display Type ME61 display

To do the setting of the calibration action, define a system as shown in [Fig. 17](#).

Type 8202 ELEMENT neutrino

Calibrate the device with a 7" process Control display Type ME61

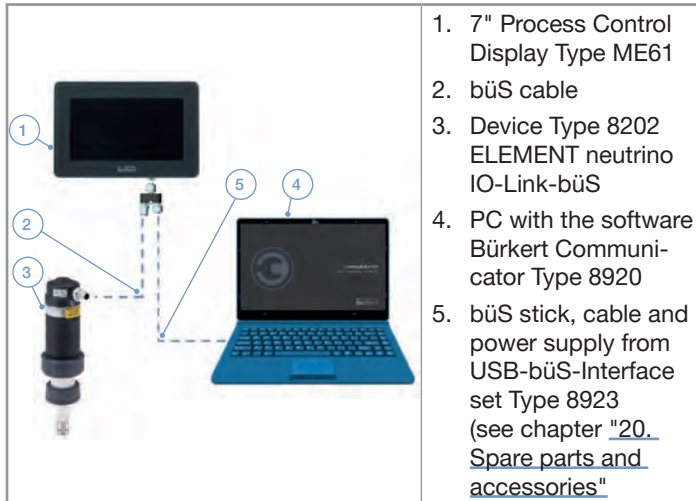

Fig. 17: Example of arrangement for setting the calibration action on the 7" Process Control Display Type ME61

The setting of the calibration action requires a PC with the software Bürkert Communicator Type 8920 but the calibration action will be afterwards accessible directly by the 7" Process Control Display Type ME61 without using a PC and the software Bürkert Communicator Type 8920.

16.2.2. Defining a displayed process value

Before engaging the setting of the calibration action, make sure that a process value of the sensor is defined and displayed by the 7" Process Control Display Type ME61. For more information, refer to the Operating Instruction of the Type ME61.

If no process value of the sensor is defined or displayed, do the following steps:

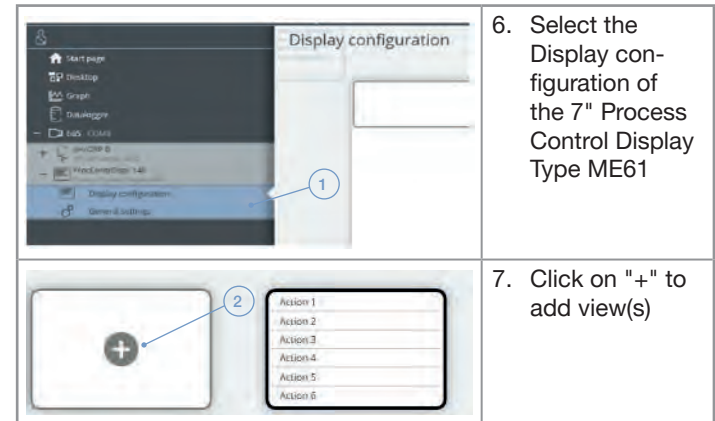

Type 8202 ELEMENT neutrino

Calibrate the device with a 7" process Control display Type ME61

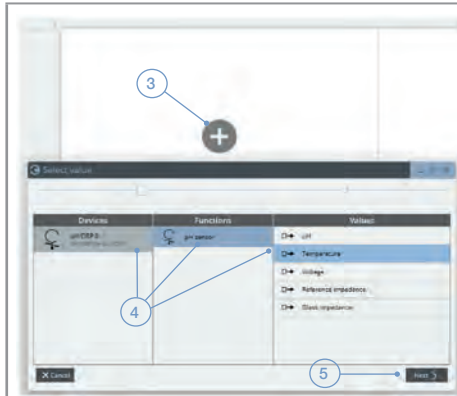

8. Select "+" on the desired view
9. Select the device, the function and the value to be displayed
10. Click on "Next"

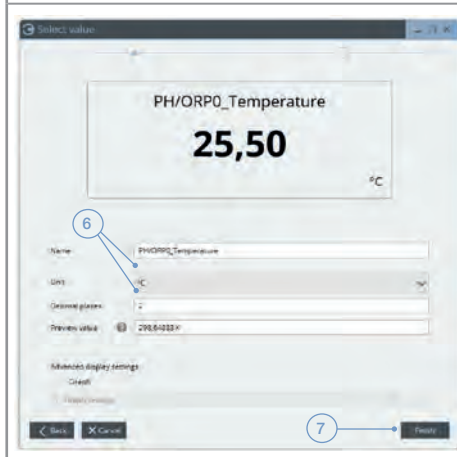

11. Define the unit of the parameter to be displayed and define the number of decimal point
12. Validate with "Finish"

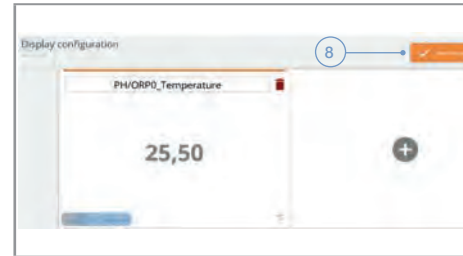

13. Click on "Apply changes" to transmit the changes to the display.
✔ The 7" Process Control Display Type ME61 restart.

16.2.3. Configuring the calibration action





Before engaging the setting of the calibration action, make sure that a process value of the sensor is defined and displayed by the 7" Process Control Display Type ME61. Refer to chap. [16.2.2.](#)

To properly set the calibration action, do the following steps:

- Make sure that all the components are connected to the bus.
- Make sure that the software Bürkert Communicator Type 8920 is open and connected to the system.

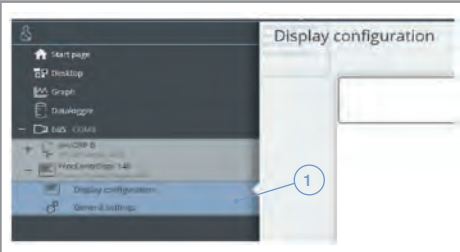
Type 8202 ELEMENT neutrino

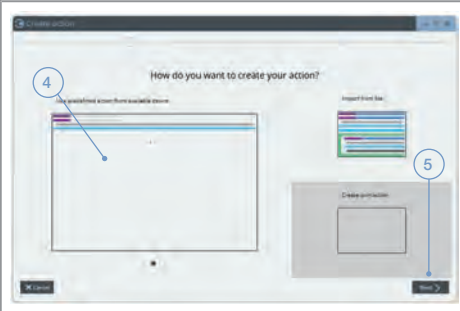
Calibrate the device with a 7" process Control display Type ME61

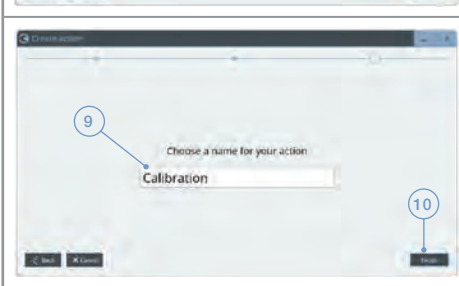
	<p>1. Select the 7" Process Control Display Type ME61 in the list of products</p>
	<p>2. Select the action menu of the display</p>
	<p>3. Select "+"</p>
	<p>4. Select the window "Use predefined action from available device" 5. Click on "Next"</p>
	<p>6. Select the device 7. Select "Calibration" in the actions list 8. Click on "Next"</p>
	<p>9. Define the name of the action (e.g. "Calibration"). 10. Click on "Finish"</p>

Type 8202 ELEMENT neutrino

Calibrate the device with a 7" process Control display Type ME61

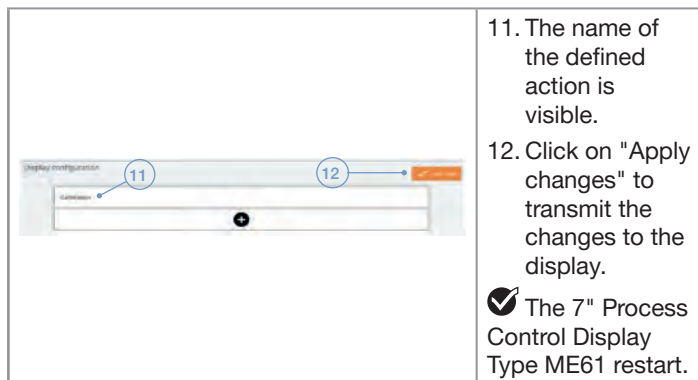

16.2.4. Using the calibration menu on the 7" Process Control Display Type ME61

Once the 7" Process Control Display Type ME61 is configured (see chapter 16.2.1), the calibration action is available without any connection to a PC and the software Bürkert Communicator Type 8920:



1. Select "Actions"
2. Perform action by pressing button 

The type of measurement, ORP or pH, defined on the product (see chapter 10.1.1) will be automatically recognized and only the available calibration possibilities are proposed:

- 1 point or 2 points calibration for pH type sensor
- ORP only for ORP type sensor

The type of measurement is visible on the top-right-hand corner of the screen (see Fig. 18 or Fig. 19).

→ Before beginning the calibration, make sure that the sensor has been correctly parametrized for pH or for ORP measurement.

Type 8202 ELEMENT neutrino

Calibrate the device with a 7" process Control display Type ME61

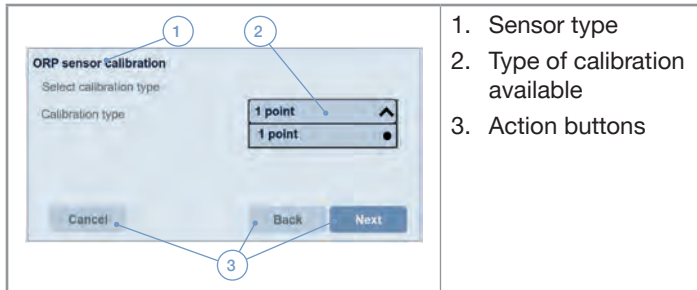

Fig. 18: ORP calibration type selection on the 7" Process Control Display Type ME61 display

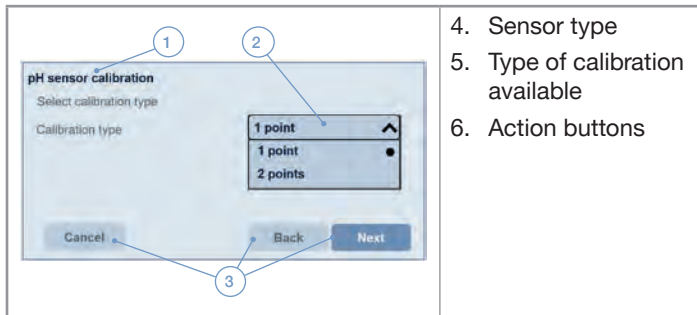

Fig. 19: pH calibration type selection on the 7" Process Control Display Type ME61 display

Select the type of calibration to be performed and follow the displayed steps:

- Press the "Next" button to go to the next step.
- Press the "Back" button to return to the previous step.
- Press the "Cancel" button to cancel the on-going calibration procedure.

For more information on the 1 point calibration or on the 2 point calibration to be applied on a pH sensor, refer to chapter [12.2.2](#).

For more information on the 2 points calibration to be applied on an ORP sensor, refer to chapter [12.2.3](#).

At the end of the pH or ORP calibration procedure, a validation screen displays the parameters to be considered as output of the calibration procedure. See [Fig. 20](#).

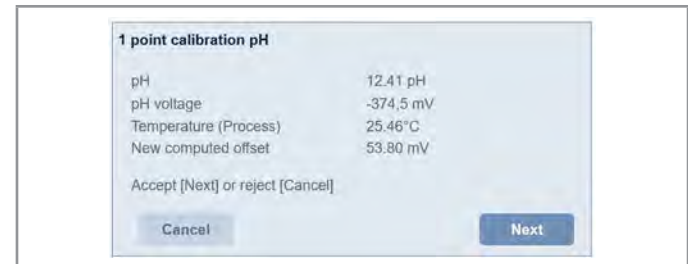

Fig. 20: Validation screen of the pH calibration procedure

→ Select "Next" to validate or select "Cancel" to return to the previous step. No changes can be done anymore after this point (see [Fig. 21](#)).

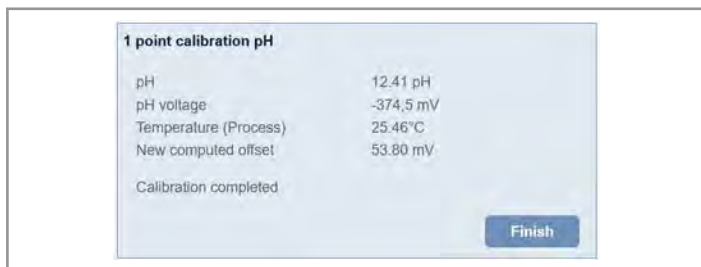

Fig. 21: Final screen of the pH calibration procedure

- Select **Finish** to complete the calibration procedure.
- If troubleshooting or if a message displayed on your product is not explained in the Operating Instructions, contact Bürkert.

17. PROCESS DATA OBJECTS

The participants to bÜS or to a CANopen fieldbus use process data objects (PDOs) to communicate the cyclic data.

17.1. Transmitted PDOs

The PDOs that are transmitted by the product are described in [Table 7](#). The structure of the PDO4 is detailed in chapter [17.2](#).

Table 7: PDOs transmitted by the product

Number	Name	Index	Data type	Unit SI	Range	Precision
PDO1	Temperature	0x2500	REAL32	K	253...398 K	0.05
	pH	0x2501	REAL32	pH	-2...16	0.1
PDO2	ORP	0x2502	REAL32	V	-2...2 V	0.0003
	Voltage	0x2503	REAL32	V	-0.59...0.59 V	0.003
PDO3	Reference impedance	0x2504	REAL32	Ohm	0...1 MOhm	-1000
	Glass impedance	0x2505	REAL32	Ohm	0...1 GOhm	1000000
PDO4	Namur status	0x2506	UNSIGNED8	-	-	-

17.2. Structure of the PDO4

The PDO4 uses 1 byte. The PDO4 indicates the NAMUR status of the device ([Table 8](#)).

Table 8: *Device status indicator in accordance with NAMUR NE 107, edition 2006-06-12*

Colour according to NE 107	Decimal value of PDO4 (for a PLC)	Diagnostics event according to NE 107	Meaning
Red	5	Failure, error or fault	Due to a malfunction of the device or its periphery, the measured values can be incorrect.
Orange	4	Check function	Ongoing work on the device (for example, checking the correct behaviour of the outputs by simulating measurement values); the output signal is temporarily invalid (e.g. frozen).
Yellow	3	Out of specification	The ambient conditions or process conditions for the device are outside the permitted ranges. Device-internal diagnostics point to problems in the device or with the process properties.
Blue	2	Maintenance required	The device continues to measure but a function is temporarily restricted. → Do the required maintenance operation.
Green	1	-	Diagnostics are active and no diagnostics event has been generated.
White	0	-	Diagnostics are inactive.

18. MAINTENANCE

18.1. Safety instructions



DANGER

Risk of injury due to pressure in the installation.

- ▶ Stop the circulation of fluid and release the pressure before loosening the connections.

Risk of injury due to electrical voltage.

- ▶ If the device is installed either in a wet environment or outdoors, all the electrical voltages must be of max. 35 V DC.
- ▶ Before carrying out work on the system, disconnect the electrical power for all the conductors and isolate it.
- ▶ All equipment connected to the device must be double insulated with respect to the mains according to the standard UL/EN 61010-1.
- ▶ Observe all applicable accident protection and safety guidelines for electrical equipment.

Risk of injury due to high fluid temperatures.

- ▶ Use safety gloves to handle the device.

Risk of injury due to the nature of the fluid.

- ▶ Respect the prevailing regulations on accident prevention and safety relating to the use of dangerous fluids.



WARNING

Risk of injury due to non-conforming maintenance.

- ▶ Maintenance must only be carried out by qualified and skilled staff with the appropriate tools.
- ▶ Ensure that the restart of the installation is controlled after any interventions.

18.2. Cleaning the device

- Clean the device with a cloth dampened with water or a detergent compatible with the materials the device is made of.



To clean the probe, refer to the Operating Instructions of the probe.

Please feel free to contact your Bürkert supplier for any additional information.

18.3. Replacing the probe

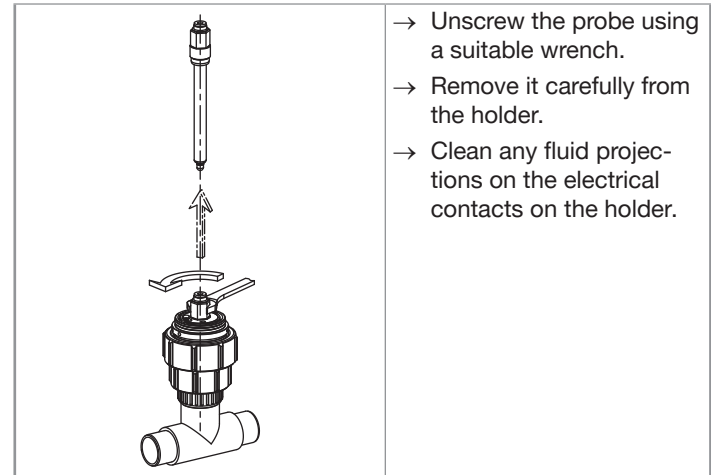
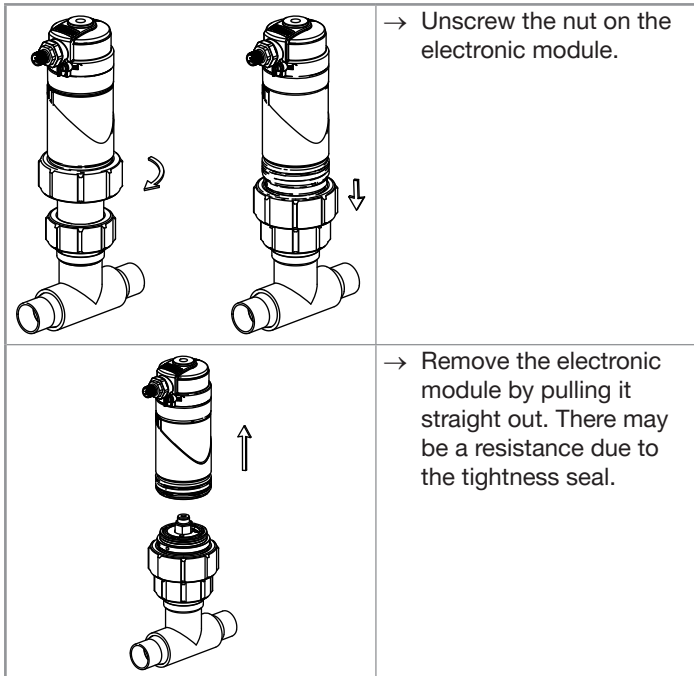

Fig. 22: Removing the probe from the holder

- Fit a new probe into the holder as shown in chapter 5.4.
- Pressurise the pipe to check the tightness of the assembly.
- Refit the electronic module to the holder as shown in chapter 6.3.
- Calibrate the probe (see chapter 12.2).

18.4. Replacing the seal in the probe holder

The seal can be replaced without removing the holder from the pipe.

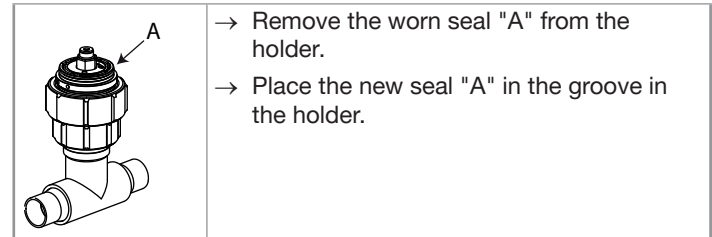
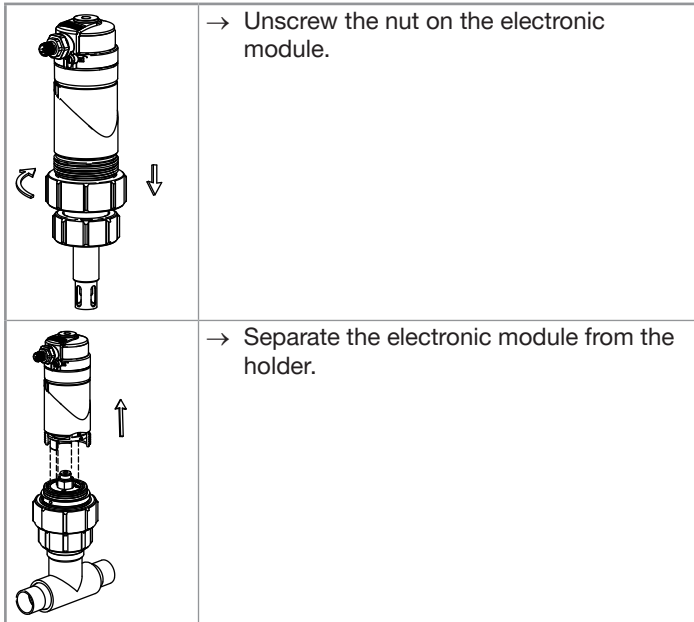

Fig. 23: Replacing the seal in the probe holder

- Pressurise the pipe to check the tightness of the assembly.
- Refit the electronic module to the holder as shown in chapter [6.3](#).

19. TROUBLESHOOTING WITH MESSAGES

Messages can only be generated if the diagnostics are enabled. Refer to chapter [13.5](#).

When a message is generated, the following actions are carried out:

- The message is written in the logbook.
- The product-status indicator changes its colour and state based on the NAMUR NE 107 recommendation. Refer to chapter [17.2](#).

→ To read the message, open the logbook. Refer to chapter [14.4](#).

19.1. Messages : failure, error or malfunction

→ If the message displayed on your product is not explained in the Operating Instructions, contact Bürkert.

19.1.1. Message **büS is not operational**

Product-status symbol	
Possible cause	Unknown cause
What to do?	→ Restart the product. → If the message is still displayed, send the product back to Bürkert.

19.1.2. Message **Factory data failure**

Product-status symbol	
Possible cause	Unknown cause
What to do?	→ Restart the product. → If the message is still displayed, send the product back to Bürkert.

19.1.3. Message **Temperature failure**

Product-status symbol	
Possible cause	Unknown cause
What to do?	→ Restart the product. → If the message is still displayed, send the product back to Bürkert.

19.1.4. Message **Sensor connection lost**

Product-status symbol	
Possible cause	Unknown cause
What to do?	→ Restart the product. → If the message is still displayed, send the product back to Bürkert.

19.1.5. Message **Measurement saturation error**

Product-status symbol	
Possible cause	Unknown cause
What to do?	→ Check if the probe holder is well connected to the electronic module. → Restart the product. → If the message is still displayed, send the product back to Bürkert.

19.1.7. Message **Error: too high pH**

Product-status symbol	
Possible cause	The pH value of the water sample is above the set limit. The message can only be displayed if the monitoring of the pH value has been configured and activated.
What to do?	→ Check the process or check the configured limits.

19.1.6. Message **Error: too low pH**

Product-status symbol	
Possible cause	The pH value of the water sample is under the set limit. The message can only be displayed if the monitoring of the pH value has been configured and activated.
What to do?	→ Check the process or check the configured limits.

19.1.8. Message **Error: too low ORP**

Product-status symbol	
Possible cause	The ORP value of the reference electrode is under the set limit. The message can only be displayed if the monitoring of the ORP value has been configured and activated.
What to do?	→ Check the process or check the configured limits.

19.1.9. Message **Error: too high ORP**

Product-status symbol	
Possible cause	<p>The ORP value of the reference electrode is above the set limit.</p> <p>The message can only be displayed if the monitoring of the ORP value has been configured and activated.</p>
What to do?	→ Check the process or check the configured limits.

19.1.11. Message **Error: too high temperature**

Product-status symbol	
Possible cause	<p>The temperature value of the water sample is above the set limit.</p> <p>The message can only be displayed if the monitoring of the temperature value has been configured and activated.</p>
What to do?	→ Check the process or check the configured limits.

19.1.10. Message **Error: too low temperature**

Product-status symbol	
Possible cause	<p>The temperature value of the water sample is under the set limit.</p> <p>The message can only be displayed if the monitoring of the temperature value has been configured and activated.</p>
What to do?	→ Check the process or check the configured limits.

19.1.12. Message **Error: too low voltage**

Product-status symbol	
Possible cause	<p>The voltage value of the measuring cell is under the set limit.</p> <p>The message can only be displayed if the monitoring of the voltage value has been configured and activated.</p>
What to do?	→ Check the process.

19.1.13. Message **Error: too high voltage**

Product-status symbol	
Possible cause	The voltage value of the measuring cell is above the set limit. The message can only be displayed if the monitoring of the voltage value has been configured and activated.
What to do?	→ Check the process or check the configured limits.

19.1.15. Message **Error: too high reference impedance**

Product-status symbol	
Possible cause	The reference impedance of the measuring cell is above the set limit. The message can only be displayed if the monitoring of the reference impedance has been configured and activated.
What to do?	→ Check the process or check the configured limits.

19.1.14. Message **Error: too low reference impedance**

Product-status symbol	
Possible cause	The reference impedance of the measuring cell is under the set limit. The message can only be displayed if the monitoring of the reference impedance has been configured and activated.
What to do?	→ Check the process.

19.1.16. Message **Error: too low glass impedance**

Product-status symbol	
Possible cause	The glass impedance of the measuring cell is under the set limit. The message can only be displayed if the monitoring of the glass impedance has been configured and activated.
What to do?	→ Check the process.

19.1.17. Message **Error: too high glass impedance**

Product-status symbol	
Possible cause	The glass impedance of the measuring cell is above the set limit. The message can only be displayed if the monitoring of the glass impedance has been configured and activated.
What to do?	→ Check the process or check the configured limits.

19.2. Messages : function check

→ If the message displayed on your product is not explained in the Operating Instructions, contact Bürkert.

19.2.1. Message **Simulation mode active**

Product-status symbol	
Possible cause	You are checking the correct behaviour of the system or of the product.
What to do?	→ If you have finished to check the behaviour of the system or of the product, set the parameter Simulation -----> Status to Off .

19.3. Messages : out of specification

→ If the message displayed on your product is not explained in the Operating Instructions, contact Bürkert.

19.3.1. Message **Warning: too low pH**

Product-status symbol	
Possible cause	The pH value of the water sample is under the set limit. The message can only be displayed if the monitoring of the pH value has been configured and activated.
What to do?	→ Check the process or check the configured limits.

19.3.2. Message **Warning: too high pH**

Product-status symbol	
Possible cause	The pH value of the water sample is above the set limit. The message can only be displayed if the monitoring of the pH value has been configured and activated.
What to do?	→ Check the process or check the configured limits.

19.3.3. Message **Warning: too low ORP**

Product-status symbol	
Possible cause	The ORP value of the reference electrode is under the set limit. The message can only be displayed if the monitoring of the ORP value has been configured and activated.
What to do?	→ Check the process or check the configured limits.

19.3.5. Message **Warning: too low temperature**

Product-status symbol	
Possible cause	The temperature value of the water sample is under the set limit. The message can only be displayed if the monitoring of the temperature value has been configured and activated.
What to do?	→ Check the process or check the configured limits.

19.3.4. Message **Warning: too high ORP**

Product-status symbol	
Possible cause	The ORP value of the reference electrode is above the set limit. The message can only be displayed if the monitoring of the ORP value has been configured and activated.
What to do?	→ Check the process or check the configured limits.

19.3.6. Message **Warning: too high temperature**

Product-status symbol	
Possible cause	The temperature value of the water sample is above the set limit. The message can only be displayed if the monitoring of the temperature value has been configured and activated.
What to do?	→ Check the process or check the configured limits.

19.3.7. Message **Warning: too low voltage**

Product-status symbol	
Possible cause	The voltage value of the measuring cell is under the set limit. The message can only be displayed if the monitoring of the voltage value has been configured and activated.
What to do?	→ Check the process or check the configured limits.

19.3.8. Message **Warning: too high voltage**

Product-status symbol	
Possible cause	The voltage value of the measuring cell is above the set limit. The message can only be displayed if the monitoring of the voltage value has been configured and activated.
What to do?	→ Check the process or check the configured limits.

19.3.9. Message **Warning: too low reference impedance**

Product-status symbol	
Possible cause	The reference impedance of the measuring cell is under the set limit. The message can only be displayed if the monitoring of the reference impedance has been configured and activated.
What to do?	→ Check the process or check the configured limits.

19.3.10. Message **Warning: too high reference impedance**

Product-status symbol	
Possible cause	The reference impedance of the measuring cell is above the set limit. The message can only be displayed if the monitoring of the reference impedance has been configured and activated.
What to do?	→ Check the process or check the configured limits.

19.3.11. Message **Warning: too low glass impedance**

Product-status symbol	
Possible cause	The glass impedance of the measuring cell is under the set limit. The message can only be displayed if the monitoring of the glass impedance has been configured and activated.
What to do?	→ Check the process or check the configured limits.

19.3.12. Message **Warning: too high glass impedance**

Product-status symbol	
Possible cause	The glass impedance of the measuring cell is above the set limit. The message can only be displayed if the monitoring of the glass impedance has been configured and activated.
What to do?	→ Check the process or check the configured limits.

19.4. Messages : maintenance required

→ If the message displayed on your product is not explained in the Operating Instructions, contact Bürkert.

19.4.1. Message **Calibration date has expired**

Product-status symbol	
Possible cause	• The calibration date is due.
What to do?	→ Calibrate the product.

20. SPARE PARTS AND ACCESSORIES



CAUTION

Risk of injury and damage caused by the use of unsuitable parts.

Incorrect accessories and unsuitable replacement parts may cause injuries and damage the device and the surrounding area.

- ▶ Use only original accessories and original replacement parts from Bürkert.

Spare part	Article number
Seal in EPDM, Ø 46 mm, for the probe holder	559169
Seal in EPDM for cover / box tightness	561752

Accessories	Article number
pH probe, 0...14 pH, 0...+80 °C, 0...6 bar, FLATRODE pH 120 mm	561025
pH probe, 0...14 pH, -10...+60 °C, 0...6 bar, LOGOTRODE pH 120 mm	427114
pH probe, 0...14 pH, 0...+130 °C, 0...6 bar, UNITRODE PLUS pH 120 mm	560376
pH probe, 0...14 pH, 0...+130 °C, 0...16 bar, CERATRODE pH 120 mm	418319
pH probe, 0...14 pH, -10...+40 °C, 0...6 bar, PLASTRODE pH 120 mm	560377
Redox probe, -2000...+2000 mV, 0...+80 °C, 0...6 bar, FLATRODE Redox 120 mm	561027
Redox probe, -2000...+2000 mV, -10...+50 °C, 0...6 bar, LOGOTRODE Redox 120 mm	560379
Redox probe, -2000...+2000 mV, 0...+130 °C, 0...6 bar, UNITRODE Redox 120 mm	560378
Storage solution for pH or redox probe (KCl 3M), 500 ml	418557
Buffer solution, 500 ml, pH = 4.01	418540
Buffer solution, 500 ml, pH = 7	418541
Buffer solution, 500 ml, pH = 10.01	418543

Accessories	Article number
Redox solution 475 mV, 500 ml	418555
Cleaning solution kit for pH/redox probes, 3x500 ml	560949
Type 8923 - USB-büS Interface Set	772426

21. PACKAGING, TRANSPORT

NOTICE

Damage due to transport

Transport may damage an insufficiently protected device.

- ▶ Transport the device in shock-resistant packaging and away from humidity and dirt.
- ▶ Do not expose the device to temperatures that may exceed the admissible storage temperature range.
- ▶ Protect the electrical interfaces using protective plugs.

22. STORAGE

NOTICE

Poor storage can damage the device.

- ▶ Store the device in a dry place away from dust.
- ▶ Storage temperature: -10...+60 °C (without probe).

23. DISPOSAL

Environmentally friendly disposal



- ▶ Follow national regulations regarding disposal and the environment.
- ▶ Collect electrical and electronic devices separately and dispose of them as special waste.

Further information at country.burkert.com.

country.burkert.com