

Type 2103, 2104, 2105

Pneumatically operated diaphragm valve



Operating Instructions

We reserve the right to make technical changes without notice.
Technische Änderungen vorbehalten.
Sous réserve de modifications techniques.

© Bürkert Werke GmbH & Co. KG, 2008 – 2024

Operating Instructions 2408/12_EUen_00805642 / Original DE

CONTENTS

1	OPERATING INSTRUCTIONS	6
1.1	Symbols.....	6
1.2	Definition of terms.....	6
2	AUTHORIZED USE	7
3	BASIC SAFETY INSTRUCTIONS	8
4	GENERAL INFORMATION.....	10
4.1	Contact address.....	10
4.2	Warranty	10
4.3	Information on the internet	10
5	DEVICE DESCRIPTION	11
5.1	General description.....	11
5.1.1	Properties	11
5.2	Versions	11
5.2.1	Actuator sizes	11
5.2.2	Pilot pressure.....	11
5.3	Options	11
5.4	Designated application area.....	12
6	STRUCTURE AND FUNCTION.....	13
6.1	Structure.....	13
6.1.1	2/2-way valve Type 2103.....	13
6.1.2	2/3-way valve Type 2103.....	13
6.1.3	T-valve Type 2104.....	14
6.1.4	Tank bottom valve Type 2105.....	14
6.1.5	Diaphragm valve with VA actuator 225.....	15
6.2	Function.....	15
6.2.1	Control function (CF) 2/2-way valve	15
6.2.2	Control function (SF) 2/3-way valve	16
6.2.3	Setting of the center position with the 2/3-way valve	16

7	TECHNICAL DATA	18
7.1	Standards and directives.....	18
7.2	Type label	18
7.3	Labeling of the forged steel valve body.....	19
7.4	Labeling of the tube valve body (VP)	19
7.5	Labelling on cast valve body.....	20
7.6	Operating conditions	21
7.6.1	Temperature ranges.....	21
7.6.2	Pressure ranges 2/2-way valve.....	22
7.6.3	Pressure ranges 2/3-way valve.....	30
7.7	General technical data.....	31
8	INSTALLATION.....	32
8.1	Notes on installation	32
8.2	Installation position.....	32
8.2.1	Installation position 2/2-way valve type 2103	32
8.2.2	Installation position T-body type 2104	33
8.2.3	Installation position tank bottom valve type 2105.....	34
8.3	Before installation	34
8.3.1	Preparatory work	34
8.4	Remove the actuator from the valve body.....	34
8.5	Installation of the valve body	35
8.5.1	Installation 2-way body and T-valve body	35
8.5.2	Welding of the tank bottom body	35
8.6	Installation of the actuator (welded or glued body).....	37
8.7	Align actuator	39
8.8	Pneumatic connection.....	40
8.8.1	Connection of the control medium	40
8.9	Removal.....	41
9	ELECTRICAL CONTROL UNIT	42
10	MAINTENANCE	43
10.1	Maintenance.....	43

10.1.1	Actuator	43
10.1.2	Wearing parts of the diaphragm valve	43
10.1.3	Inspection intervals	44
10.1.4	Visual inspection	44
10.1.5	Service life of the diaphragm	44
10.1.6	Cleaning	44
11	REPLACING THE DIAPHRAGM	45
11.1.1	Replacement of the diaphragm for control function A	45
11.1.2	Replacement of the diaphragm for control function B and I	46
11.1.3	Switch between PTFE and EPDM diaphragms	48
12	MALFUNCTIONS	49
13	REPLACEMENT PARTS	50
13.1	Diaphragm	50
14	PACKAGING, TRANSPORT	52
15	STORAGE	52
16	DISPOSAL	52

1 OPERATING INSTRUCTIONS

The operating instructions describe the entire life cycle of the device. Keep these instructions ready to hand at the operation site.

Important safety information.

- ▶ Carefully read these instructions.
- ▶ Observe in particular the safety instructions, authorized use and operating conditions.
- ▶ Persons, who work on the device, must read and understand these instructions.

1.1 Symbols

DANGER

Warns of an immediate danger.

- ▶ Failure to observe the warning will result in fatal or serious injuries.

WARNING

Warns of a potentially dangerous situation.

- ▶ Failure to observe the warning may result in serious or fatal injuries.

CAUTION

Warns of a possible danger.

- ▶ Failure to observe the warning may result in a moderate or minor injury.

NOTE

Warns of damage to property.

- ▶ Failure to observe the warning may result in damage to the device or other equipment.

 Important additional information, tips and recommendations.

 Refers to information in these operating instructions or in other documentation.

- ▶ Designates an instruction to prevent risks.
- Designates a procedure which you must carry out.

1.2 Definition of terms

In these instructions the term “device” denotes the following device types: 2103, 2104, 2105.

- Ex area: stands for potentially explosive area.
- Ex approval: stands for approval in the potentially explosive area.

2 AUTHORIZED USE

Incorrect use of the device can be dangerous to people, nearby equipment and the environment.

- ▶ The diaphragm valves of Types 2103, 2104 and 2105 are designed for the controlled flow of liquid and gaseous media.
- ▶ In potentially explosive atmospheres, only use devices that are approved for this purpose. These devices are identified by a separate Ex type label. Before use, note the information on the separate Ex type label and the Ex additional instructions or the separate Ex operating instructions.
- ▶ During use observe the authorized data, the operating conditions and conditions of use specified in the contract documents, operating instructions and on the type label.
- ▶ Protect device from damaging environmental influences (e.g. radiation, humidity, steam, etc.). If anything is unclear, consult the relevant sales office.
- ▶ The device may be used only in conjunction with third-party devices and components recommended and authorized by Bürkert.
- ▶ Correct transportation, correct storage and installation and careful use and maintenance are essential for reliable and faultless operation.
- ▶ Use the device only as intended.

3 BASIC SAFETY INSTRUCTIONS

These safety instructions do not consider any contingencies or incidents which occur during installation, operation and maintenance. The operator is responsible for observing the location-specific safety regulations, also with reference to the personnel.



Risk of injury from high pressure and discharge of medium.

- ▶ Before working on the device or system, switch off the pressure. Vent or empty the lines.

Danger of bursting from overpressure.

- ▶ Observe the specifications on the type label for maximal control and medium pressure.
- ▶ Observe permitted medium temperature.

Risk of injury from electric shock (when electrical component installed).

- ▶ Before reaching into the device or the equipment, switch off the power supply and secure to prevent reactivation!
- ▶ Observe applicable accident prevention and safety regulations for electrical equipment!

Risk of injury when opening the actuator.

The actuator contains a tensioned spring. If the actuator is opened, there is a risk of injury from the spring-jumping out.

- ▶ Do not open the actuator.

Risk of injury from moving parts in the device!

- ▶ Do not reach into openings.
- ▶ Operate 3-position actuator with transparent cap only.

Danger due to loud noises.

- ▶ Depending on the operating conditions, the device may generate loud noises. More detailed information on the likelihood of loud noises is available from the relevant sales office.
- ▶ Wear hearing protection when in the vicinity of the device.

Danger of burns and risk of fire.

Quickly switching actuators or hot medium may cause the surface of the device to become hot.

- ▶ Only touch the device while wearing protective gloves.
- ▶ Keep the device away from highly flammable substances and media.

Leaking medium when the diaphragm is worn.

- ▶ Regularly check relief bore for leaking medium.
- ▶ If medium is leaking out of the relief bore, change the diaphragm.
- ▶ If the media is hazardous, protect the area surrounding the discharge point against dangers.

To prevent injury, ensure:

- ▶ That the system cannot be activated unintentionally.
- ▶ Only trained technicians may perform installation and maintenance work.
- ▶ Perform installation work and maintenance work using suitable tools only.
- ▶ Do not transport, install or remove heavy devices without the aid of a second person and using suitable auxiliary equipment.
- ▶ After an interruption, ensure that the process is restarted in a controlled manner. Observe sequence!
 1. Apply supply voltage or pneumatic supply.
 2. Charge the device with medium.
- ▶ The device may be operated only when in perfect condition and in consideration of the operating instructions.
- ▶ Observe the safety regulations specific to the plant for application planning and operation of the device.
- ▶ The plant operator is responsible for the safe operation and handling of the plant.
- ▶ Observe the general rules of technology.
- ▶ The exhaust air may be contaminated with lubricants in the actuator.

To prevent damage to property of the device, ensure:

- ▶ Supply the media connections only with those media which are specified as flow media in the chapter entitled "[7 Technical data](#)".
- ▶ Do not make any changes on the device and do not subject it to mechanical stress.
- ▶ Do not transport, install or remove heavy devices without the aid of a second person and using suitable auxiliary equipment.

4 GENERAL INFORMATION

4.1 Contact address

Germany

Bürkert Fluid Control Systems
Sales Center
Chr.-Bürkert-Str. 13-17
D-74653 Ingelfingen
Tel. : + 49 (0) 7940 - 10 91 111
Fax : + 49 (0) 7940 - 10 91 448
E-mail: info@burkert.com

International

Contact addresses are found on the final pages of the printed Quickstart.

You can also find information on the Internet under:

country.burkert.com

4.2 Warranty

The warranty is only valid if the device is used as authorized in accordance with the specified application conditions.

4.3 Information on the internet

The operating instructions and data sheets for Type 2103, 2104 and 2105 can be found on the Internet at:

country.burkert.com

5 DEVICE DESCRIPTION

5.1 General description

The piston-controlled diaphragm valve Type 2103, 2104 or 2105 is suitable for liquid media. Using neutral gases or air (control media), it controls the flow of dirty, aggressive, abrasive, ultrapure or sterile media, even highly viscous media can be used (flow media).

5.1.1 Properties

- Any flow direction.
- Self-draining for appropriate installation. The ends of the utilized connections must be cylindrical.
- Optimized deadleg.
- Low-turbulence flow.
- High flow values by the streamlined valve body.
- Maintenance-free under normal conditions.
- PTFE/EPDM diaphragms can be easily replaced with EPDM diaphragms.

5.2 Versions

There are 2 versions of the type 2103, 2104 and 2105:

- **Standard version – without separate Ex type label.**
The standard version must not be used in the potentially explosive area.
- **Ex version – with separate Ex type label.**
The Ex version may be used in the potentially explosive area. In doing so, observe the specifications on the separate Ex type label and the additional information enclosed with the device together with safety instructions for the Ex area.

5.2.1 Actuator sizes

The piston-controlled diaphragm valve is available for the following actuator sizes: ø 50 mm, ø 70 mm, ø 90 mm, ø 130 mm and ø 225.

3-position actuator is available for the following actuator sizes ø 50 mm, ø 70 mm, ø 90 mm.

5.2.2 Pilot pressure

Designs with lower pilot pressure (reduced spring force) are available on request. Contact your Bürkert sales office or our Sales Center, e-mail: info@burkert.com

5.3 Options

A detailed description of the options and associated accessories can be found on the Bürkert homepage in the data sheet for Type 2XXX: [Link](#)

5.4 Designated application area

The diaphragm valve has been designed for use with dirty, aggressive, abrasive, ultrapure or sterile media. The valves may only control media which do not corrode the body and the seal materials (see type label).

Information on the resistance of materials to the media is available from your Bürkert sales office or in internet.

- Dirty, aggressive, abrasive, ultrapure or sterile media.
- Highly viscous media.



Observe the maximum pressure range according to the type label.

6 STRUCTURE AND FUNCTION

6.1 Structure

The piston-controlled diaphragm valve consists of a pneumatically operated piston actuator and a 2/2-way valve body. The actuator is manufactured from polyphenylene sulphide (PPS) and stainless steel (actuator size 225 only stainless steel).

6.1.1 2/2-way valve Type 2103

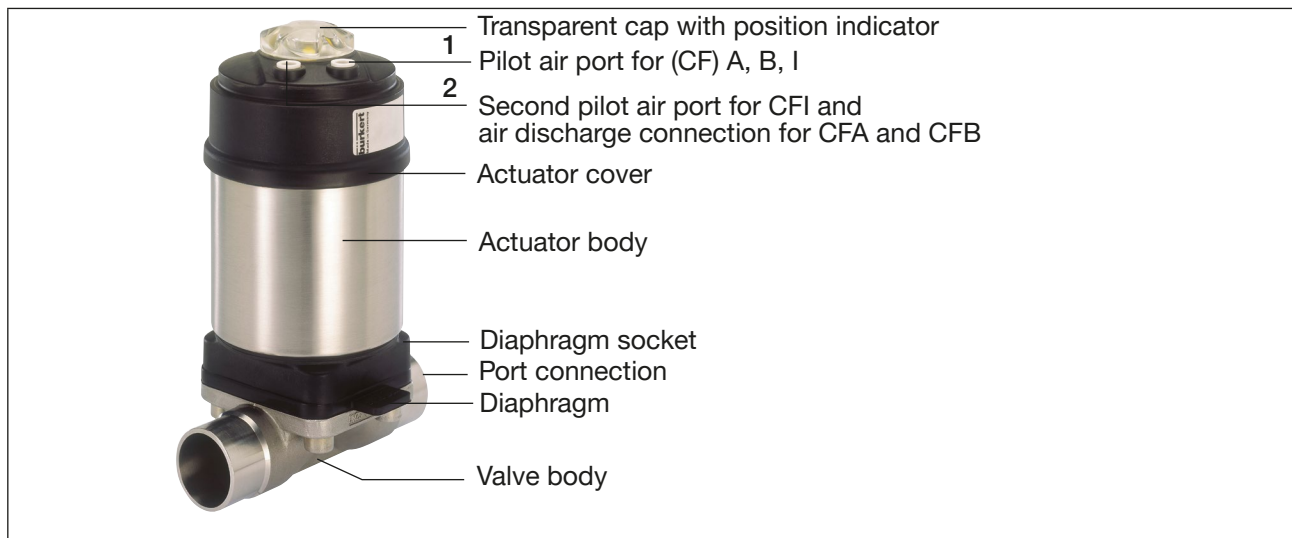

Figure 1: Structure and description, 2/2-way valve Type 2103

6.1.2 2/3-way valve Type 2103

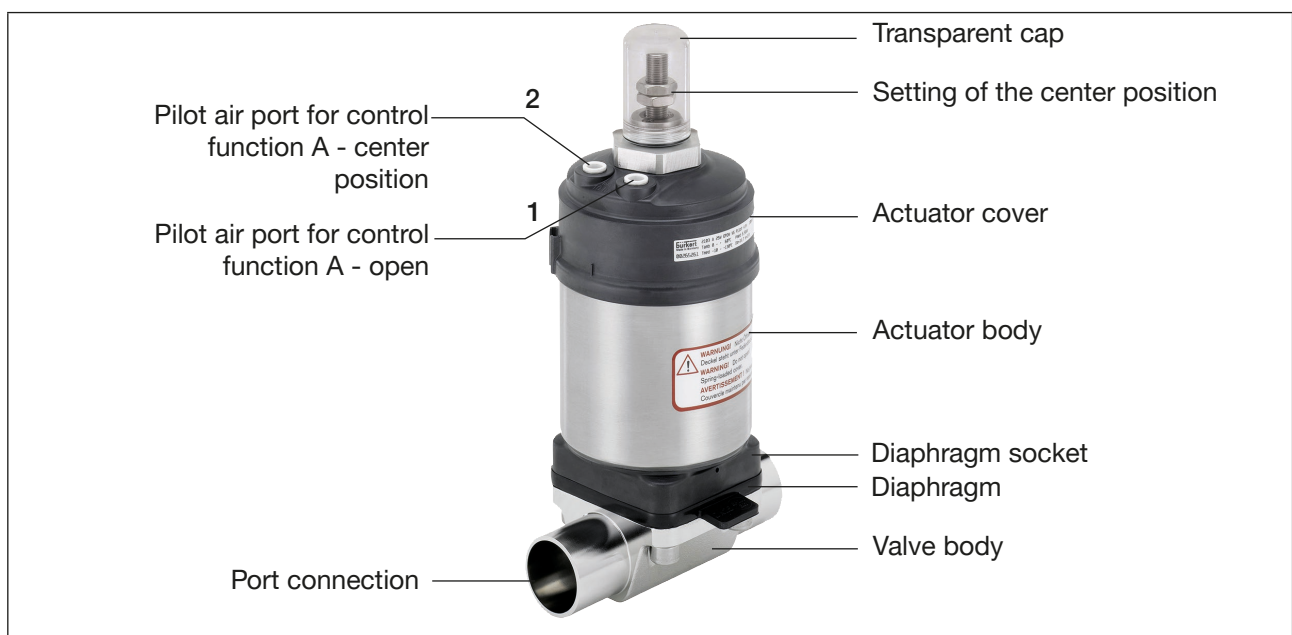

Figure 2: Structure and description, 2/3-way valve Type 2103

6.1.3 T-valve Type 2104

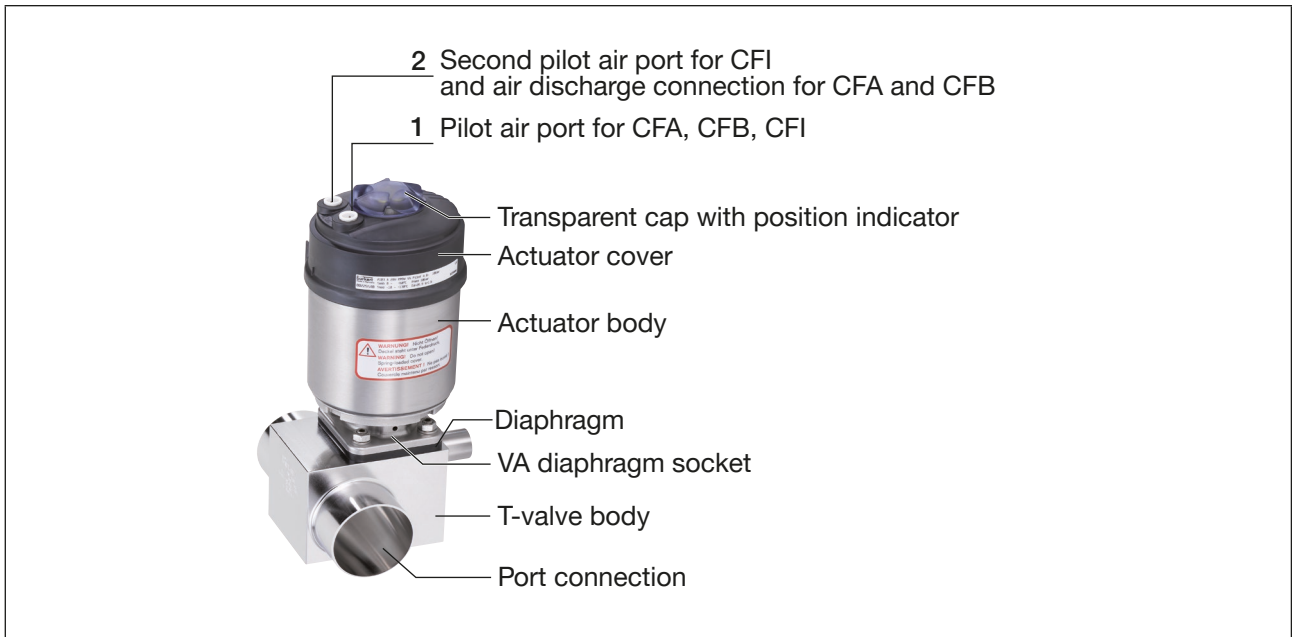

Figure 3: Structure and description, Type 2104

6.1.4 Tank bottom valve Type 2105

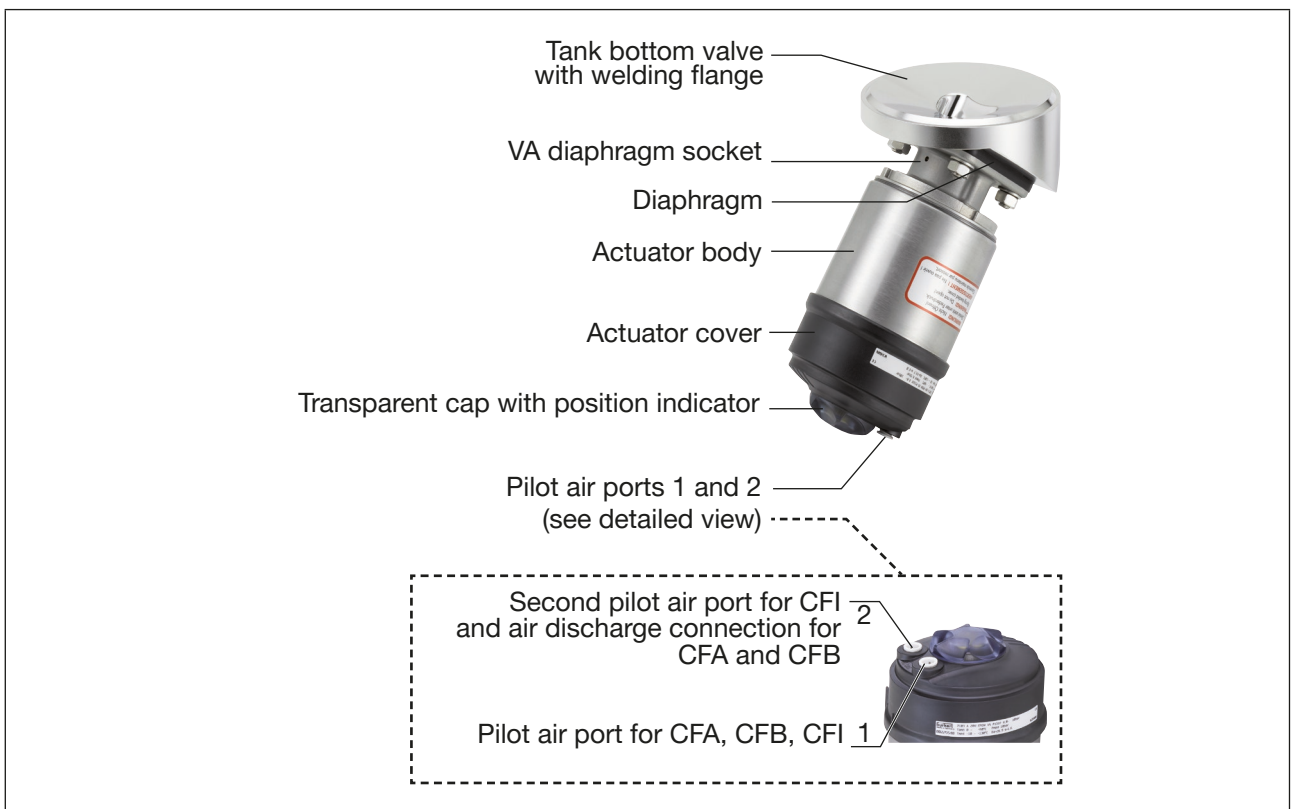

Figure 4: Structure and description, Type 2105

6.1.5 Diaphragm valve with VA actuator 225

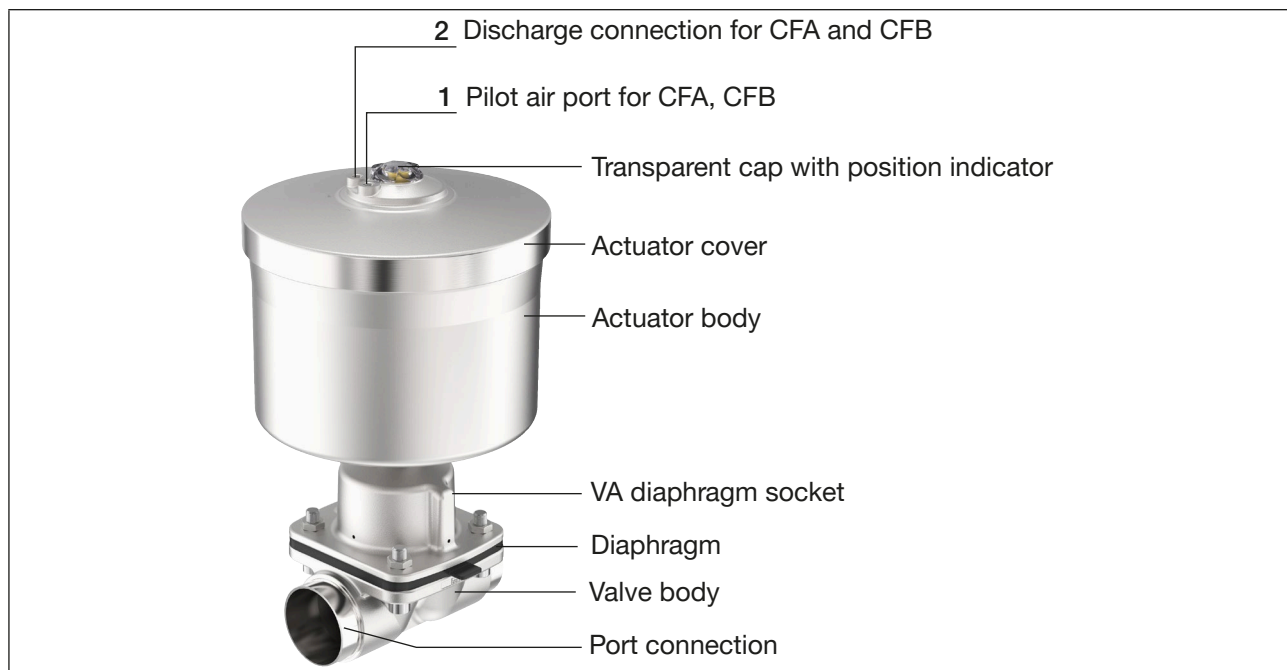

Figure 5: Diaphragm valve with VA actuator 225

6.2 Function

6.2.1 Control function (CF) 2/2-way valve

Spring force (CFA) or pneumatic pilot pressure (CFB and CFI) generates the closing force on the diaphragm pressure piece. The force is transferred via a spindle which is connected to the actuator piston.

Control function A (CFA)

Normally closed by spring action

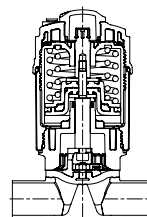
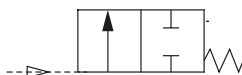

Control function B (CFB)

Normally open by spring action

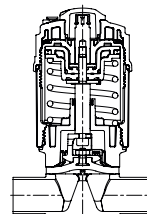
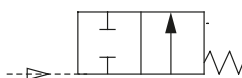

Control function I (CFI)

Actuating function via reciprocal pressurization

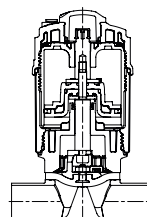
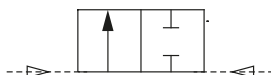

6.2.2 Control function (SF) 2/3-way valve

The 3-position diaphragm valve Type 2103 is available in control function A (CFA) only.

Control function A (CFA)

Normally closed by spring action

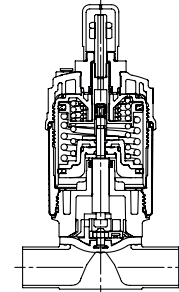
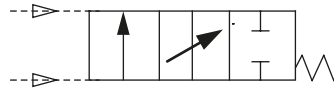

A spindle, which is connected to the actuator piston, transfers the force onto the pressure piece which presses the diaphragm against the weir in the body. Pressurization of the pilot air port 2 moves the upper movable group around the upper piston axially downwards, until the center position, preset via the nut and lock nut, has been reached. Pressurization of the pilot air port 1 moves the lower movable group around the lower piston axially upwards until it hits the upper piston and stops. This center position corresponds to a specific adjustable flow rate of the medium. If the upper air chamber is vented by pilot air port 2, both modules move upwards and the maximum stroke is reached. If the lower air chamber is vented by pilot air port 1, the spring force acts on the lower movable group and therefore moves it downwards until the valve is closed (rest position).

6.2.3 Setting of the center position with the 2/3-way valve

Open position [100 % Stroke]

Pilot air port 1: 5...7 bar

Pilot air port 2: 0 bar

Center position [0...100 % Stroke]

Pilot air port 1: 5...7 bar

Pilot air port 2: 5...7bar

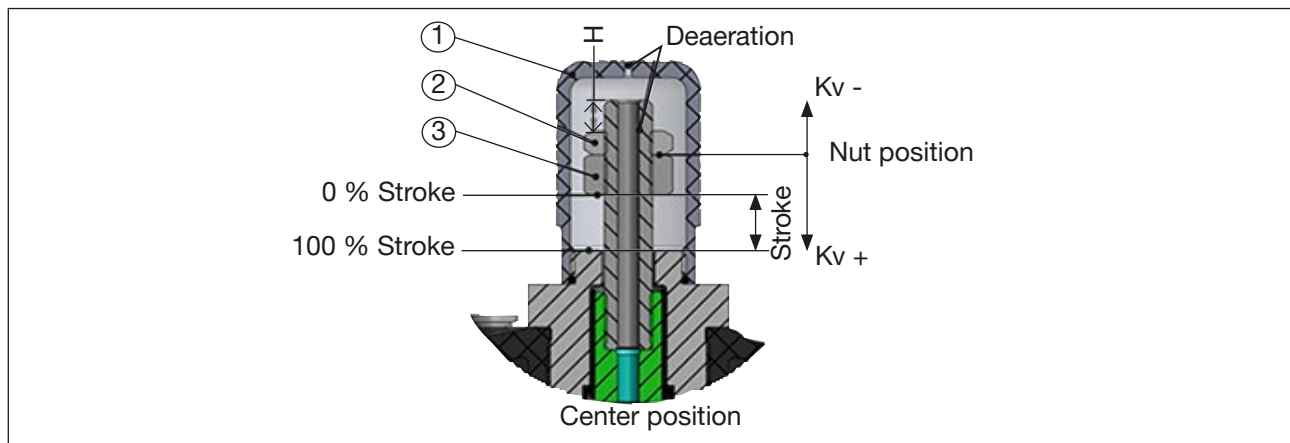

Figure 6: Setting of the center position

- Unscrew transparent cap (Position 1):
Actuator sizes 50, 70 and 90: Wrench size 28.
- Pressurize pilot air port 1 of the actuator with compressed air (5 bar).
- Loosen lock nut (Position 2):
Actuator size 50: Wrench size 13;
Actuator sizes 70 and 90: Wrench size 17.

→ Adjust the center position via the nut (Position 3).

→ Retighten lock nut (Position 2):

Actuator size 50 max. 20⁺⁵ Nm

Actuator size 70 max. 30⁺⁵ Nm

Actuator size 90 max. 45⁺⁵ Nm

→ Screw transparent cap back on.

To limit the center position to 50 % of the total stroke, set dimension H on the nuts.

Actuator size [mm]	Diaphragm size	Dimension H ±0.3 [mm]		Stroke total [mm]	
		EPDM/FKM	PTFE	EPDM/FKM	PTFE
ø 50	8	14.6	14.6	2.4	2.4
	15	12.3	-	7.0	-
ø 70	15	14.4	15.4	7.0	5.0
	20	13.4	13.9	9.0	8.0
	25	13.4	13.9	9.0	8.0
ø 90	25	16.3	16.8	9.0	8.0

Table 1: Setting of the center position to 50 % of the total stroke

7 TECHNICAL DATA

7.1 Standards and directives

The device complies with the valid EU harmonisation legislation. In addition, the device also complies with the requirements of the laws of the United Kingdom.

The harmonised standards that have been applied for the conformity assessment procedure are listed in the current version of the EU Declaration of Conformity/ UK Declaration of Conformity.

7.2 Type label



WARNING

Risk of injury from high pressure.

Excessive pressure can damage the device.

► Comply with pressure range values on the type label.

Example:

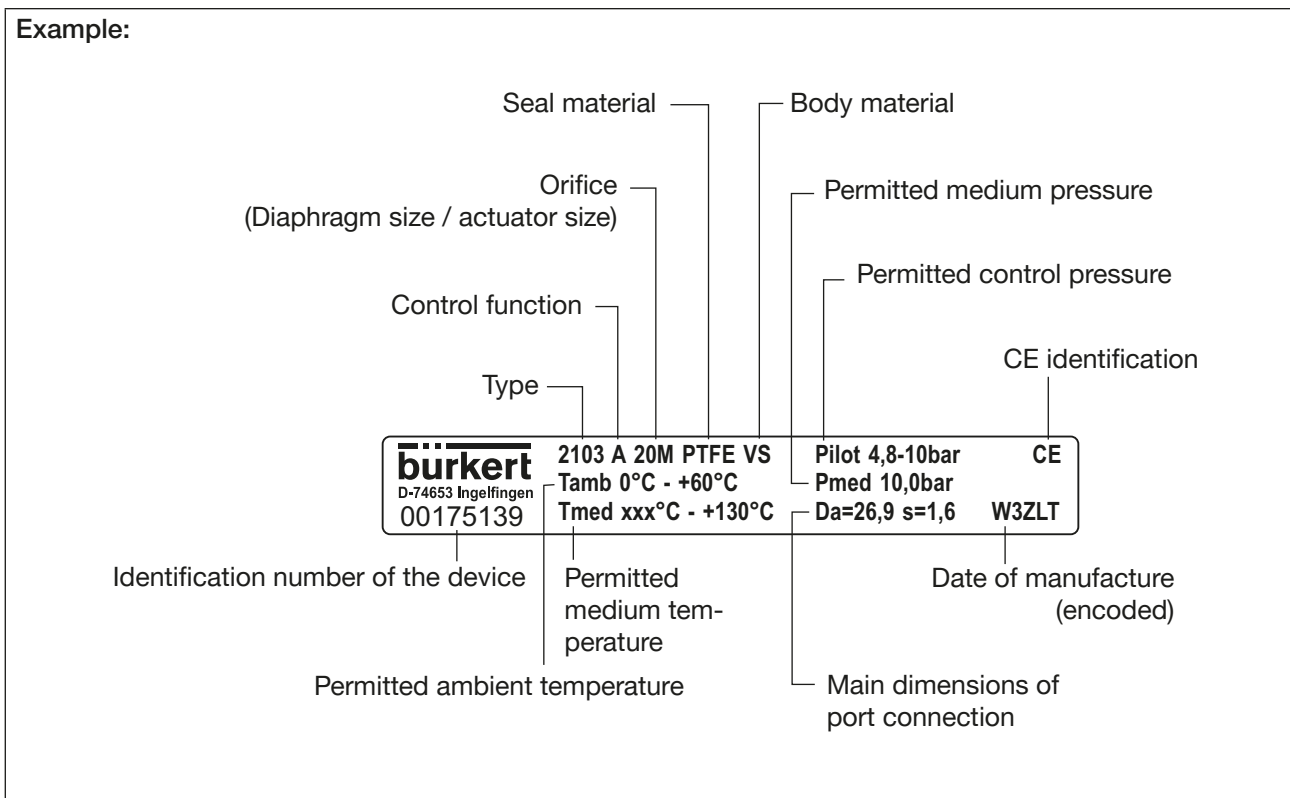

Figure 7: Description of the type label (example)

7.3 Labeling of the forged steel valve body

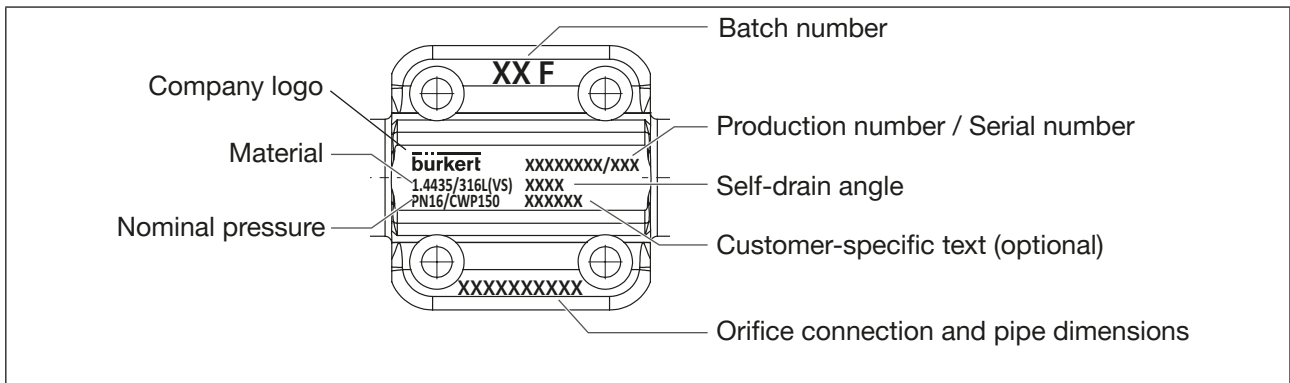

Figure 8: Labeling of the forged steel valve body

7.4 Labeling of the tube valve body (VP)

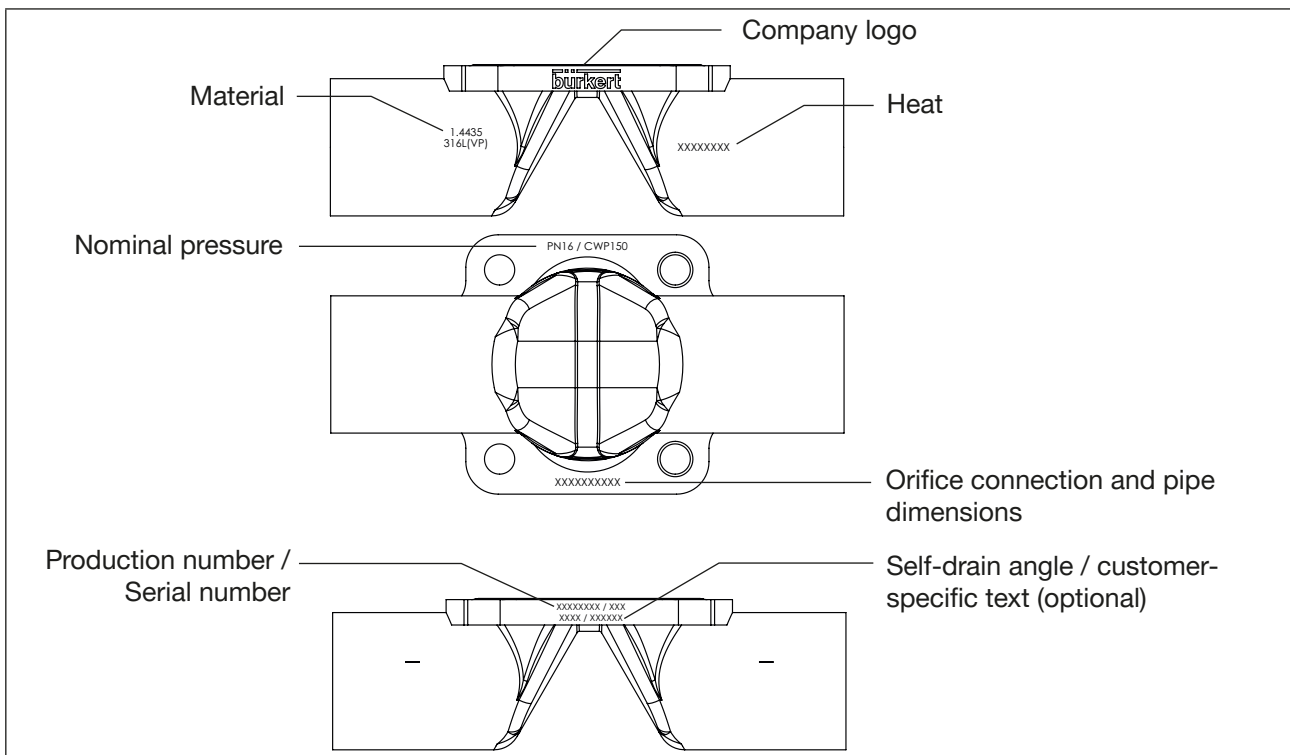

Figure 9: Labeling of the tube valve body (VP)

MAN 1000099061 ML Version: O Status: RL (released | freigegeben) printed: 03.09.2024

7.5 Labelling on cast valve body

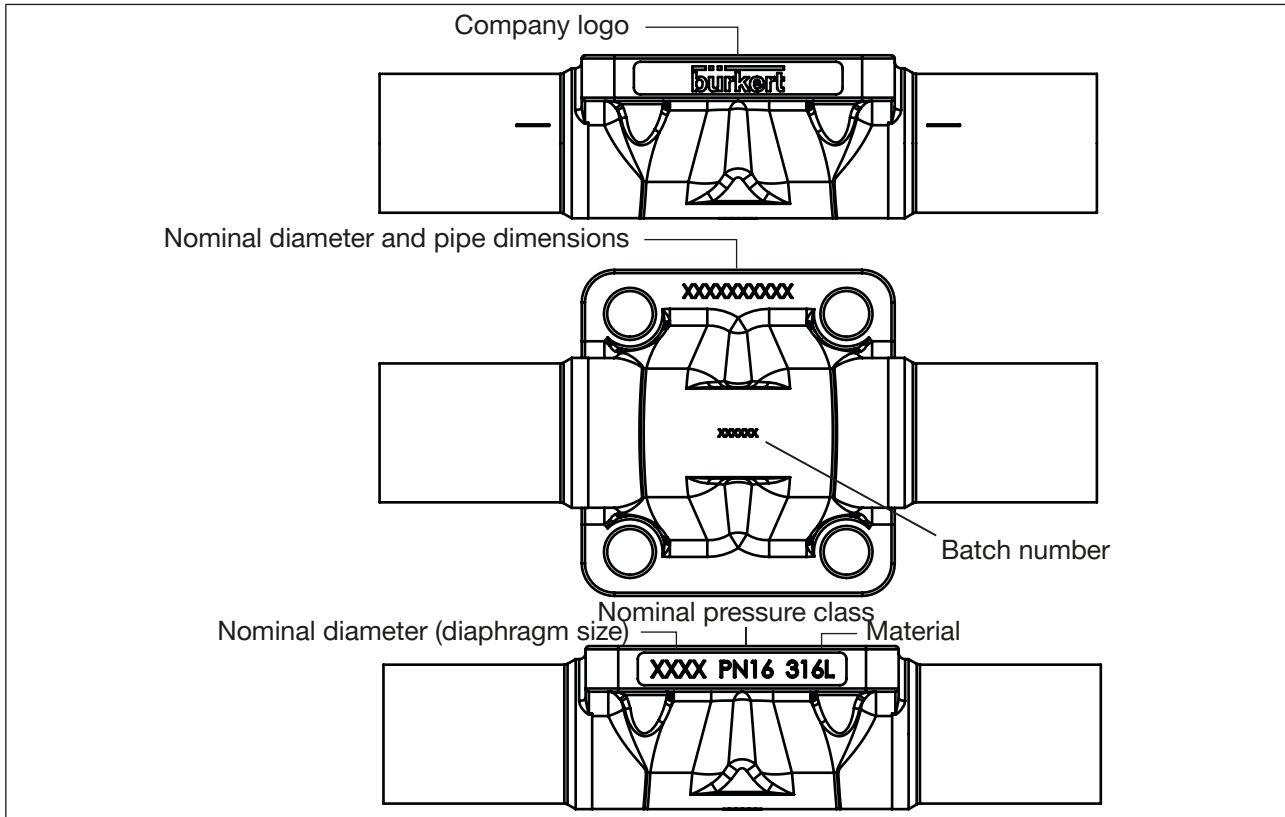

Figure 10: Labelling on cast valve body

7.6 Operating conditions

7.6.1 Temperature ranges

Permitted ambient temperature for actuators

Actuator size [mm]	Actuator material	Ambient temperature ¹⁾
ø 50	PPS	-10...+60 °C ²⁾
ø 70		
ø 90		-10...+100 °C ³⁾
ø 130		
ø 225	Stainless steel	-10...+100 °C

Table 2: Permitted ambient temperature for actuator



¹⁾ If using a pilot valve / control unit, observe its temperature range.

Medium temperature for valve body

Body material	Temperature
Stainless steel	-10...+150 °C
PP (see PT diagram "Figure 11")	+10...+90 °C
PVC-C (see PT diagram "Figure 11")	+10...+80 °C
PVC-U (see PT diagram "Figure 11")	+10...+60 °C
PVDF (see PT diagram "Figure 11")	-20...+120 °C

Table 3: Medium temperature for valve body

Permitted medium temperature for diaphragms



The indicated medium temperatures apply only to media which do not corrode or swell the diaphragm materials.

The behavior of the medium with respect to the diaphragm may be changed by the medium temperature.

The function properties, in particular the service life of the diaphragm, may deteriorate if the medium temperature increases.

Do not use the diaphragms as steam shut-off element.

Material	Temperature [°C]	Remarks
EPDM (AD)	-10...+143	Steam sterilization up to +150 °C / 60 min
FKM (FF)	0...+130	No steam / dry heat up to +150 °C / 60 min
PTFE (EA)	-10...+130	Steam sterilization up to +140 °C / 60 min
Advanced PTFE (EU)	-5...+143	Steam sterilization up to +150 °C / 60 min
GYLON® (ER)	-5...+130	Steam sterilization up to +140 °C / 60 min

Table 4: Permitted medium temperature for diaphragms

²⁾ Pilot air ports with push-in connector

³⁾ Pilot air ports with threaded bushing

7.6.2 Pressure ranges 2/2-way valve



To ensure reliable operation with pneumatic position controller, observe the permitted minimum and maximum pilot pressure on the type label.

Pilot pressure for valves with pneumatic position controller

Actuator size [mm]	Pilot pressure
ø 50	5,5...7,0 bar
ø 70	
ø 90	
ø 130	
ø 225, SFA	5,5...7,0 bar
ø 225 SFB	3,0...5,0 bar

Table 5: Pilot pressure for valves with pneumatic position controller

Maximum pilot pressure for valves without pneumatic position controller

Actuator size [mm]	Actuator material	Max. permitted pilot pressure
ø 50	PPS	10 bar
ø 70		
ø 90		7 bar
ø 130		7 bar
ø 225, SFA	Edelstahl	7 bar
ø 225 SFB		5 bar

Table 6: Maximum pilot pressure for valves without pneumatic position controller



Designs with lower pilot pressure (reduced spring force) are available on request. Contact your Bürkert sales office or our Sales Center, e-mail: info@burkert.com

Maximum permitted medium pressure

Permitted medium pressure depending on the medium temperature with plastic valve body:

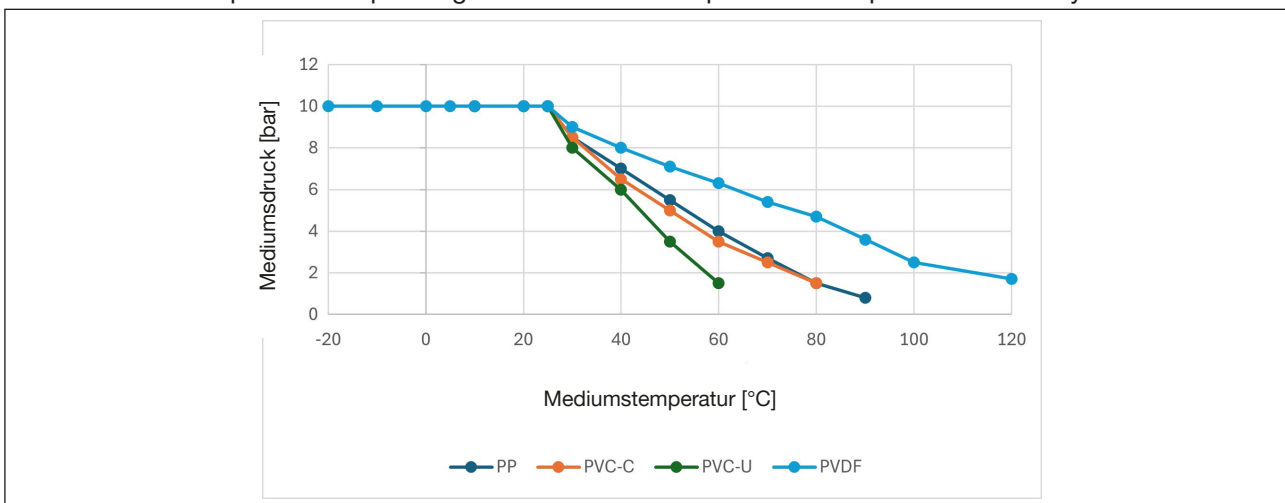

Figure 11: Graph of medium pressure / Medium temperature with plastic valve body

Operating pressure for control function A

The values apply to valve bodies made of:

- plastic
- stainless steel: block material, forged, casted and tube valve body.

Actuator size [mm]	Diaphragm size	Max. sealed medium pressure [bar]			
		Pressure on one side		Pressure on both sides	
		EPDM/FKM	PTFE	EPDM/FKM	PTFE
ø 50	8	10	10	10	10
ø 50	15	7.5	-	5	-
ø 70	15	10	10	10	10
ø 70	20	10	10	10	7.5
ø 70	25	6.5	4.5	5.5	4
ø 90		10	8	10	7
ø 90	32	8	6	6	4
ø 90	40	5.5	5	4	3
ø 130		10	10	10	9
ø 130	50	8	7	7	5
ø 130	65	5.5	3.5	2	1.5
ø 225	65	8	8	7	6.5
ø 225	80	10	8	10	7.5
ø 225	100	8	5.5	7	5

Table 7: Operating pressure for control function A

Required minimum pilot pressure depending on medium pressure

The following graphs illustrate the required minimum pilot pressure depending on the medium pressure for control functions B and I.

The values apply to valve bodies made of:

- plastic
- stainless steel: block material, forged, casted and tube valve body.

! When using Type 2103, 2104 or 2105 as a control valve, pressure conditions may deviate in some cases. These conditions appear in the diagrams.

Control function B / elastomer diaphragm

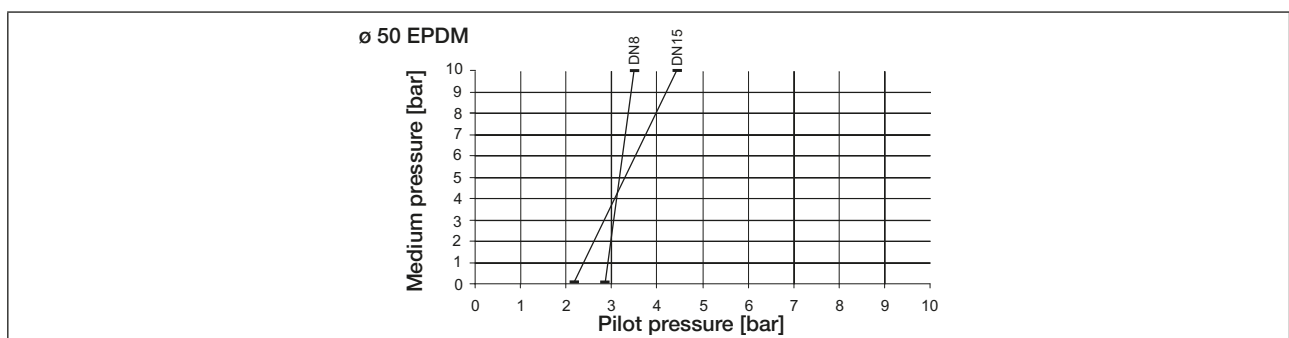

Figure 12: Pressure graph, actuator ø 50 mm, control function B, elastomer diaphragm

MAN 1000099061 ML Version: O Status: RL (released | freigegeben) printed: 03.09.2024

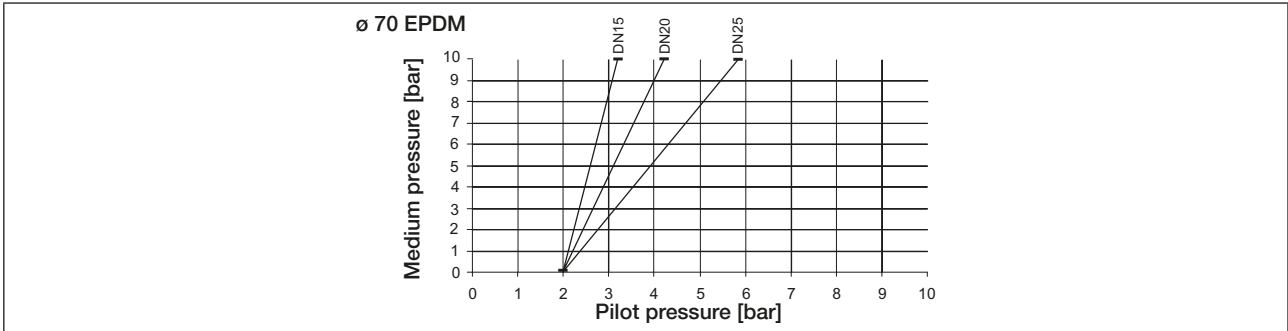

Figure 13: Pressure graph, actuator ø 70 mm, control function B, elastomer diaphragm

Graph for control valve

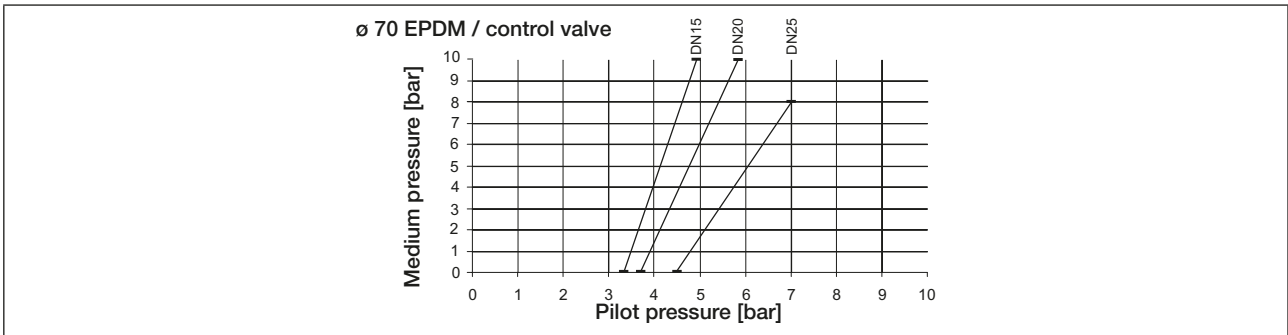

Figure 14: Pressure graph for control valve, actuator ø 70 mm, control function B, elastomer diaphragm

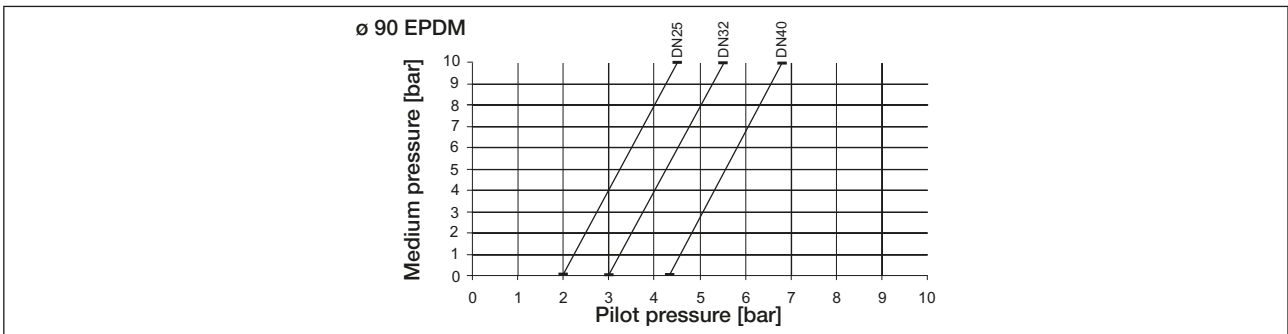

Figure 15: Pressure graph, actuator ø 90 mm, control function B, elastomer diaphragm

Graph for control valve

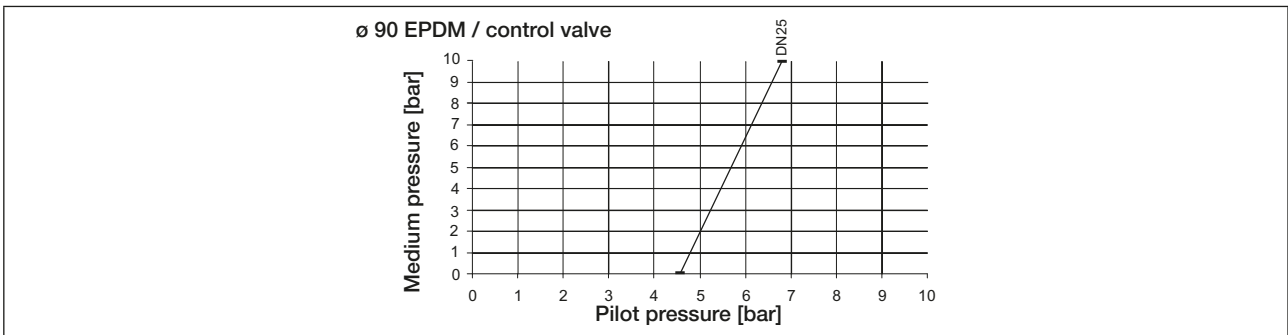

Figure 16: Pressure graph for control valve, actuator ø 90 mm, control function B, elastomer diaphragm

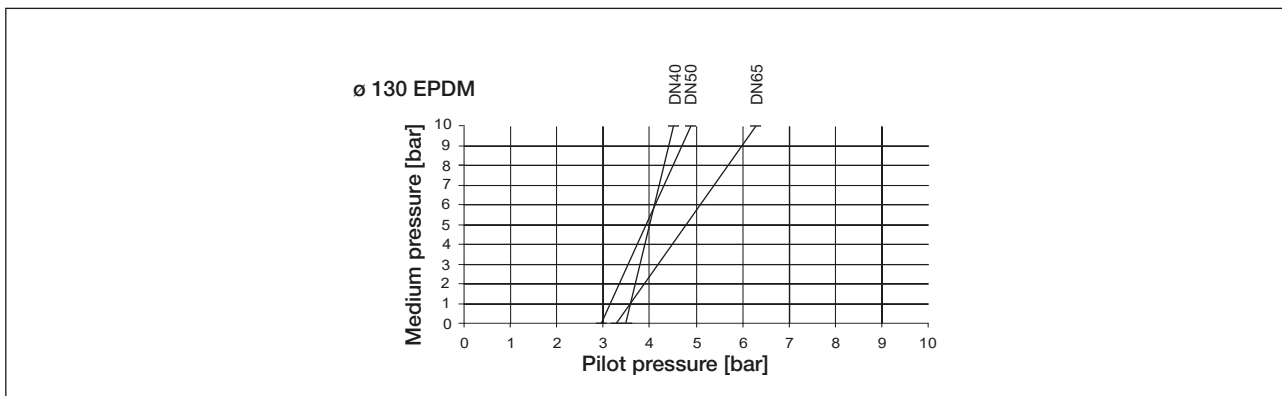

Figure 17: Pressure graph, actuator ø 130 mm, control function B, elastomer diaphragm

Graph for control valve

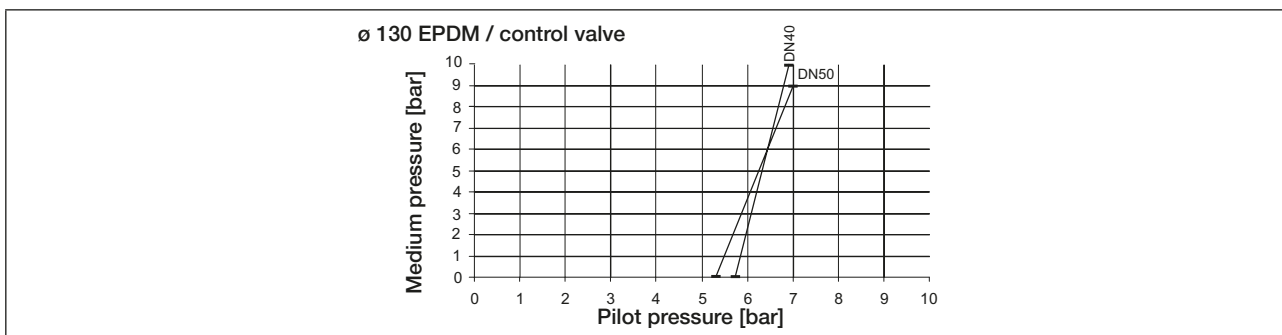

Figure 18: Pressure graph for control valve, actuator ø 130 mm, control function B, elastomer diaphragm

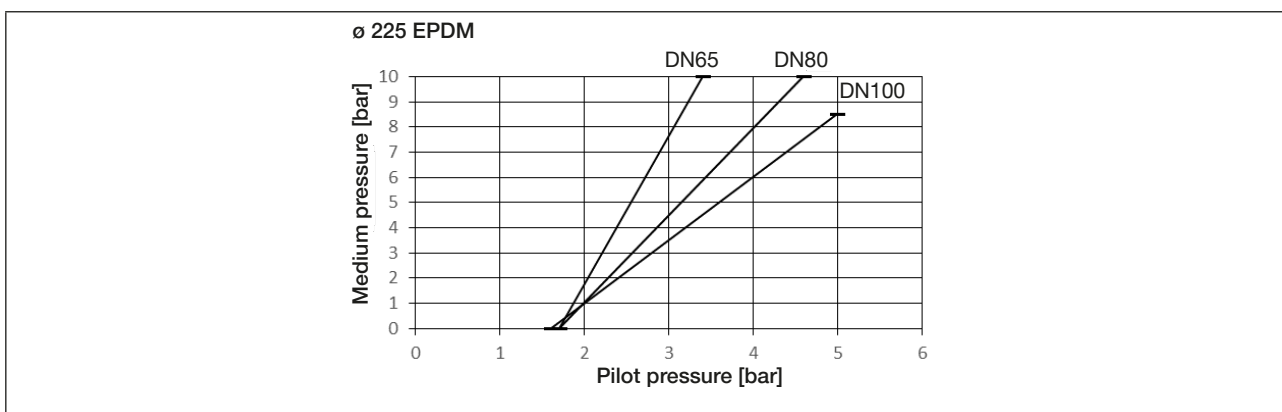

Figure 19: Pressure graph, actuator ø 225 mm, control function B, elastomer diaphragm

MAN 1000099061 ML Version: O Status: RL (released | freigegeben) printed: 03.09.2024

Control function B / PTFE elastomer diaphragm

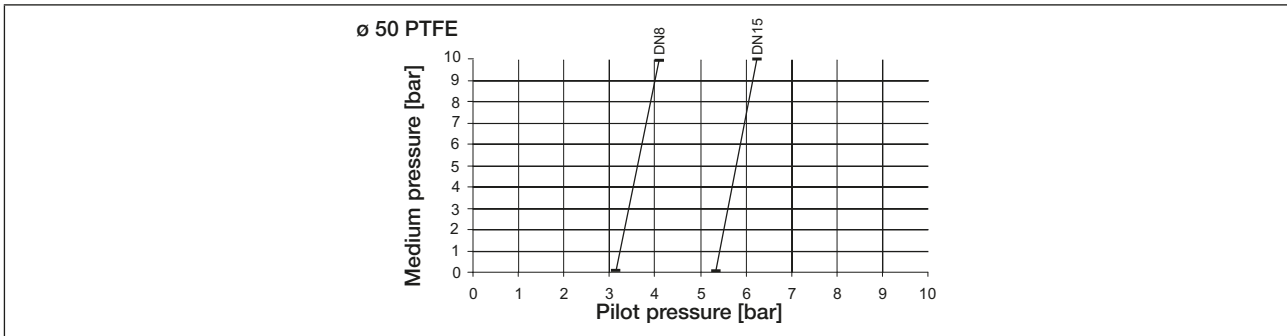

Figure 20: Pressure graph, actuator ø 50 mm, control function B, PTFE elastomer diaphragm

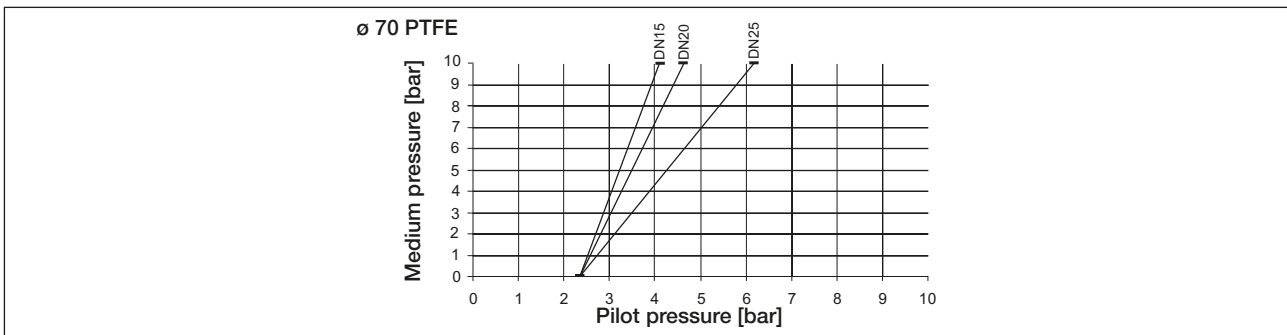

Figure 21: Pressure graph, actuator ø 70 mm, control function B, PTFE elastomer diaphragm

Graph for control valve

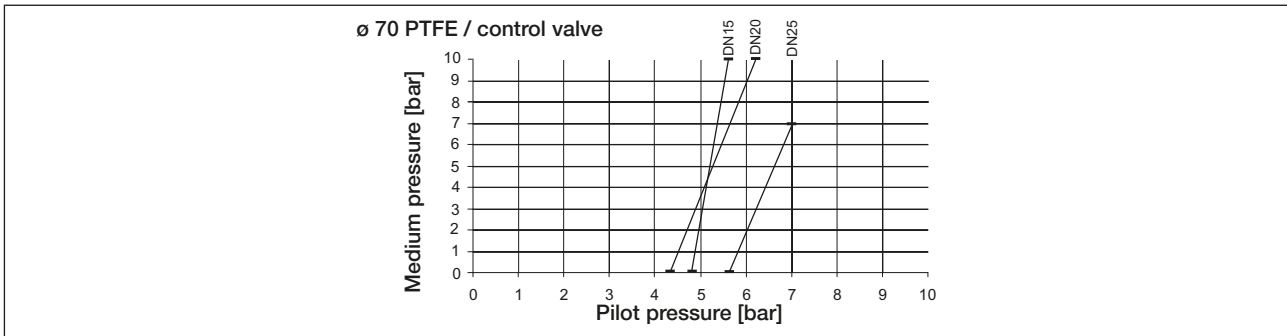

Figure 22: Pressure graph for control valve, actuator ø 70 mm, control function B, PTFE elastomer diaphragm

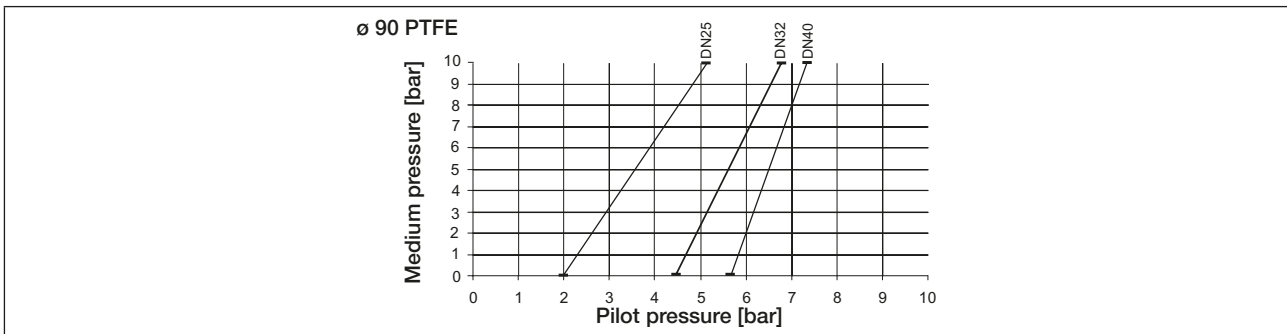

Figure 23: Pressure graph, actuator ø 90 mm, control function B, PTFE elastomer diaphragm

MAN 100099061 ML Version: O Status: RL (released | freigegeben) printed: 03.09.2024

Graph for control valve

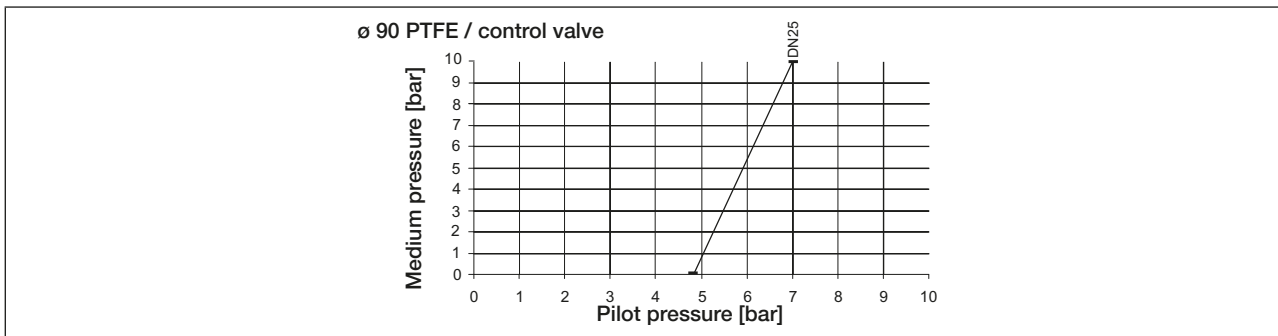

Figure 24: Pressure graph for control valve, actuator ø 90 mm, control function B, PTFE elastomer diaphragm

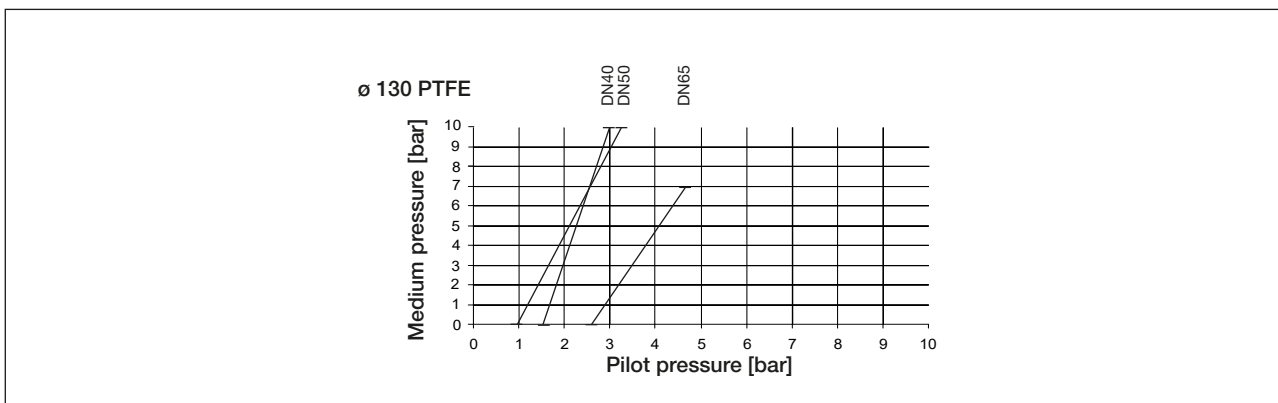

Figure 25: Pressure graph, actuator ø 130 mm, control function B, PTFE elastomer diaphragm

Graph for control valve

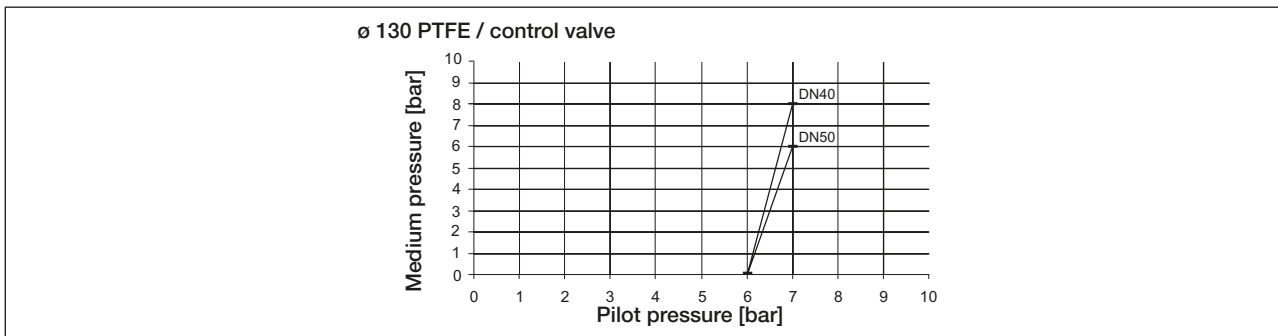

Figure 26: Pressure graph for control valve, actuator ø 130 mm, control function B, PTFE elastomer diaphragm

MAN 1000099061 ML Version: O Status: RL (released | freigegeben) printed: 03.09.2024

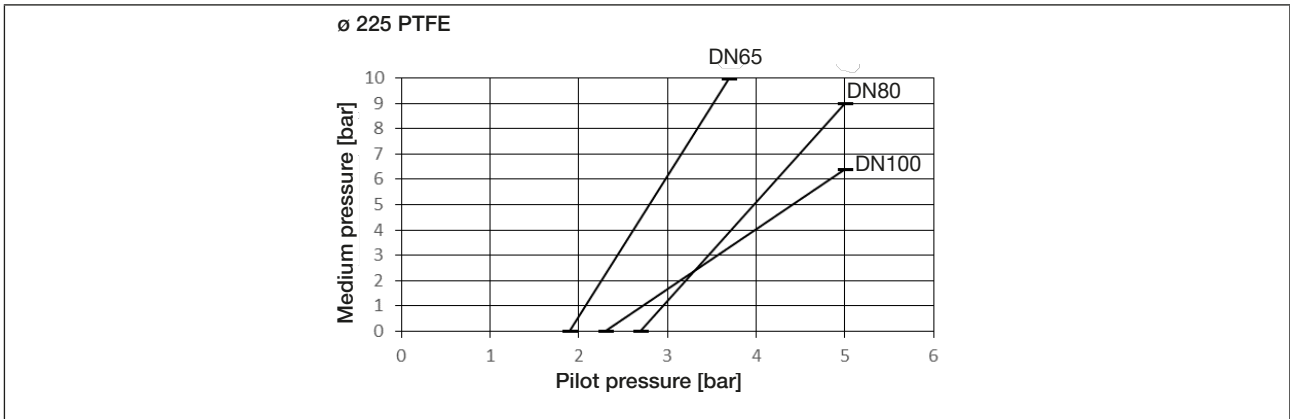

Figure 27: Pressure graph ø 225 mm, control function B, PTFE elastomer diaphragm

Control function I / elastomer diaphragm

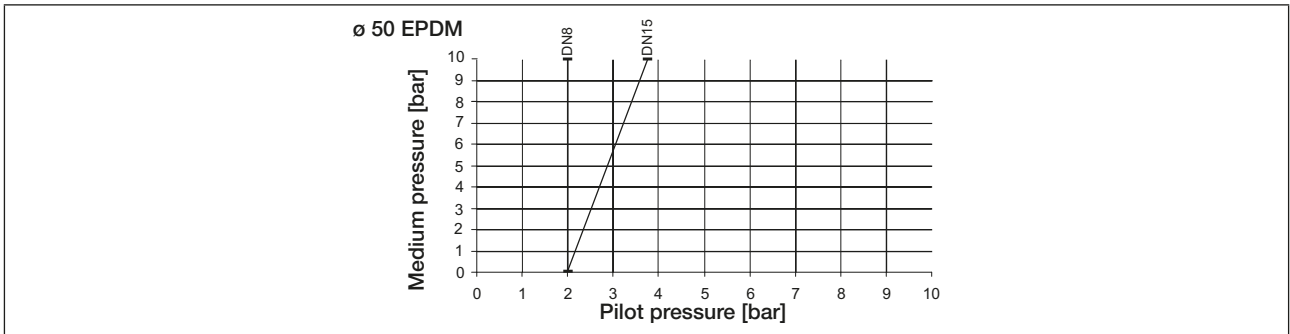

Figure 28: Pressure graph, actuator ø 50 mm, control function I, elastomer diaphragm

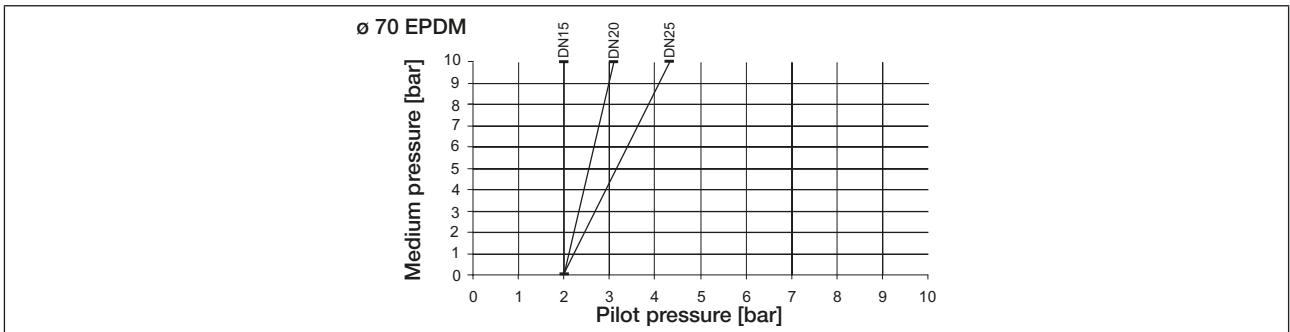

Figure 29: Pressure graph, actuator ø 70 mm, control function I, elastomer diaphragm

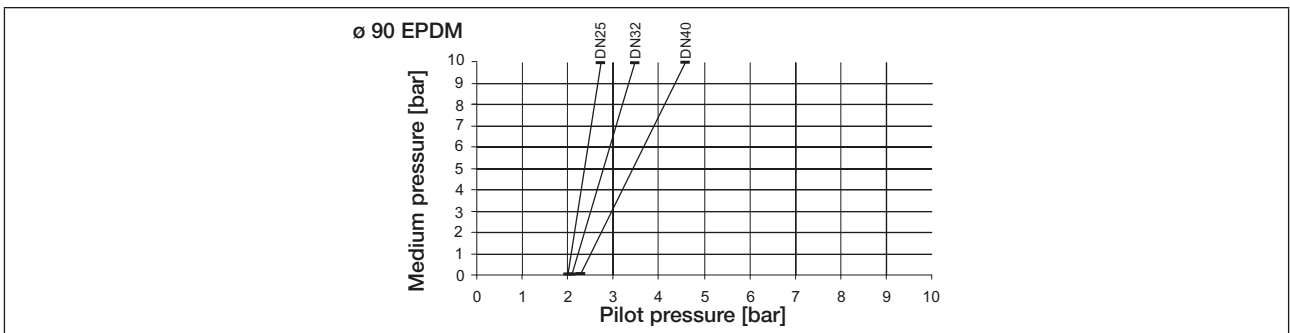

Figure 30: Pressure graph, actuator ø 90 mm, control function I, elastomer diaphragm

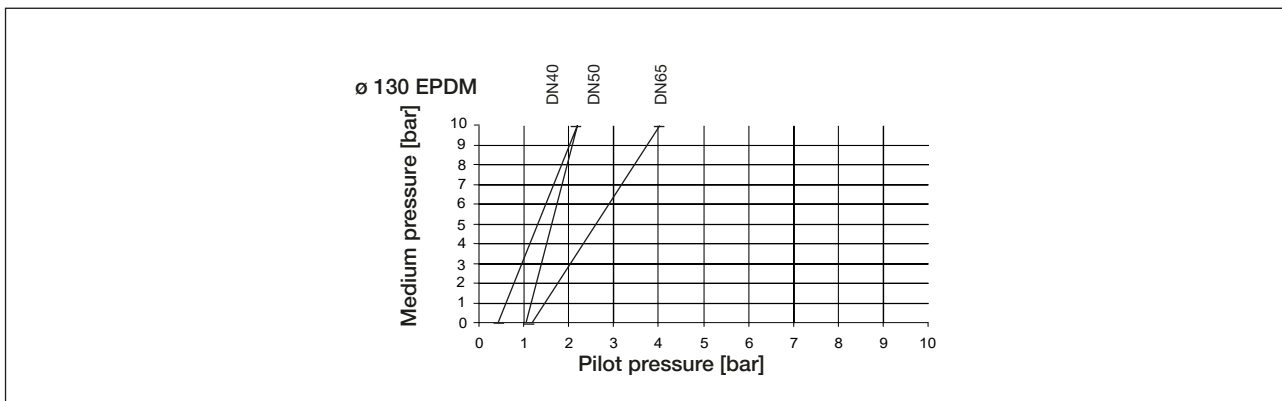

Figure 31: Pressure graph, actuator ø 130 mm, control function I, elastomer diaphragm

Control function I / PTFE elastomer diaphragm

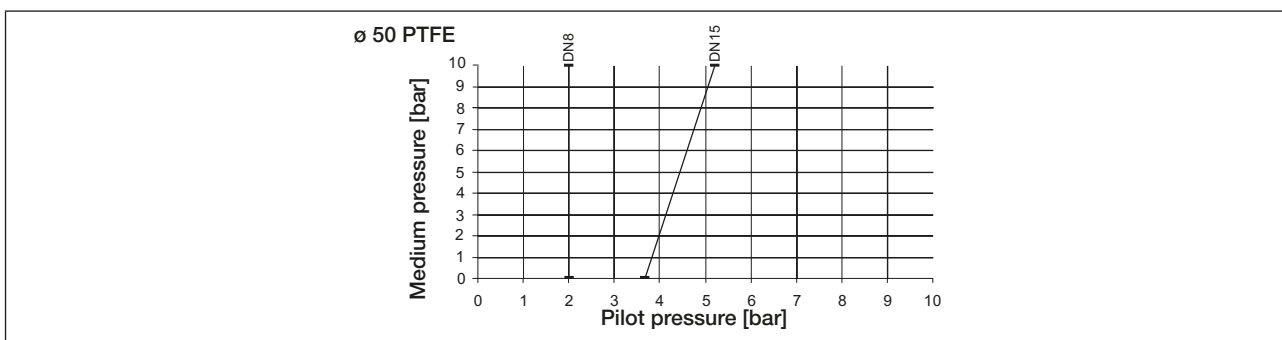

Figure 32: Pressure graph, actuator ø 50 mm, control function I, PTFE elastomer diaphragm

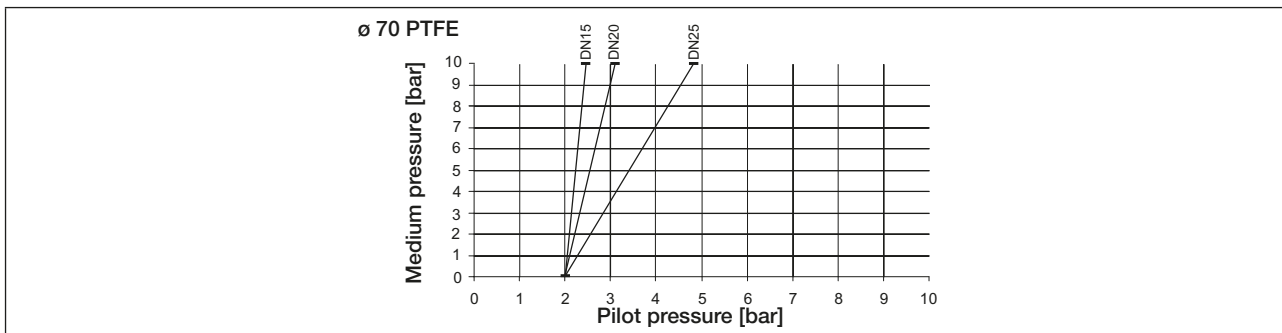

Figure 33: Pressure graph, actuator ø 70 mm, control function I, PTFE elastomer diaphragm

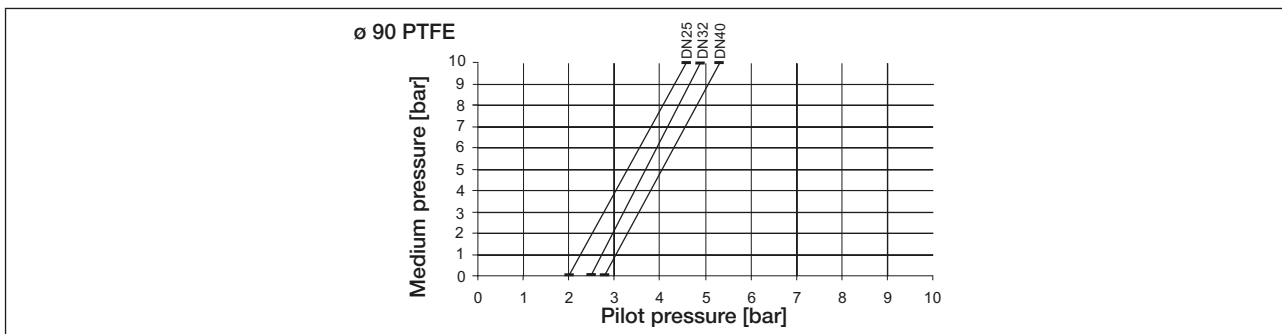

Figure 34: Pressure graph, actuator ø 90 mm, control function I, PTFE elastomer diaphragm

MAN 1000099061 ML Version: O Status: RL (released | freigegeben) printed: 03.09.2024

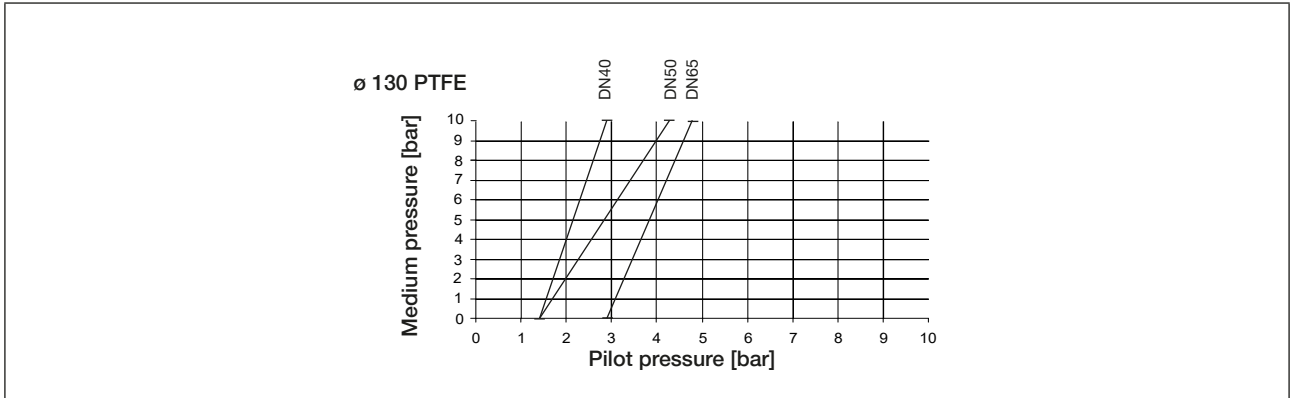

Figure 35: Pressure graph, actuator ø 130 mm, control function I, PTFE elastomer diaphragm

7.6.3 Pressure ranges 2/3-way valve



To ensure reliable operation with pneumatic position controller, observe the permitted minimum and maximum pilot pressure on the type label.

Maximal pilot pressure

Actuator size [mm]	Actuator material	Max. pilot pressure
ø 50	PPS	7 bar
ø 70		
ø 90		

Table 8: Max. pilot pressure

Operating pressure for control function A

Actuator size [mm]	Diaphragm size	Pilot pressure [bar] for medium pressure	
		0 bar	maximal
ø 50	8 EPDM / FKM	4.0	3.6
	8 PTFE	4.0	3.7
	15	4.5	3.4
ø 70	15	3.7	3.3
	20	3.7	3.3
	25	4.1	3.2
ø 90	25	4.8	3.9

Table 9: Operating pressure for control function A



Designs with lower pilot pressure (reduced spring force) are available on request. Contact your Bürkert sales office or our Sales Center, e-mail: info@burkert.com

Operating pressure for control function A

The values apply to valve bodies made of:

- plastic
- stainless steel: block material, forged, casted and tube valve body

Actuator size [mm]	Diaphragm size	Max. sealed medium pressure [bar]			
		Pressure on one side		Pressure on both sides	
		EPDM/FKM	PTFE	EPDM/FKM	PTFE
ø 50	8	10	10	10	10
ø 50	15	7.5	-	5	-
ø 70	15	10	10	10	10
ø 70	20	10	5	10	4
ø 70	25	6.5	3.5	5.5	2
ø 90	25	10	8	10	7

Table 10: Operating pressure for control function A

7.7 General technical data

Materials

Valve bodies Type 2103 Precision casting (VG), forged steel (VS), tube valve body (VP), Plastic (PP, PVC-C, PVC-U und PVDF)

Valve bodies Type 2104, 2105 VA block material

Actuator PPS and stainless steel

Sealing elements FKM and EPDM

Diaphragm EPDM, PTFE, FKM

Connections

Pilot air connection Plug-in hose connector 6/4 mm or 1/4" others on request

Medium connection Weld end: in accordance with DIN EN ISO 1127 (ISO 4200), DIN 11850 R2, DIN 11866 (ASME-BPE) other connections on request

Media

Control medium neutral gases, air

Flow media liquids; ultrapure, sterile, aggressive or abrasive media

Installation position

Type 2103, 2104 any position, preferably with the actuator face up.

Type 2105 preferably with the actuator to the bottom (tank bottom valve)

Actuator size ø 50 mm, ø 70 mm, ø 90 mm, ø 130 mm, ø 225

Degree of protection IP67 in accordance with IEC 529 / EN 60529

8 INSTALLATION

WARNING

Risk of injury from improper installation.

- ▶ Installation may be carried out by authorised technicians only and with the appropriate tools.
- ▶ Secure system from unintentional activation.
- ▶ Following assembly, ensure a controlled restart.

For control function I – Danger if pilot pressure fails.

For control function I control and resetting occur pneumatically. If the pressure fails, no defined position is reached.

- ▶ To ensure a controlled restart, first pressurize the device with pilot pressure, then switch on the medium.

CAUTION

Risk of injury due to a heavy device.

A heavy device can fall down during transport or during installation and cause injuries.

- ▶ Transport, install and dismantle a heavy device with the help of another person.
- ▶ Use appropriate tools.

NOTE

Note the following when installing the device in the plant.

- ▶ The device and the relief bore must be accessible to allow inspection and maintenance work.

8.1 Notes on installation

- The installation location must be easily accessible and provide sufficient clearance for installation, removal and maintenance of the device
- Use suitable lifting gear to lift a heavy device
- Only lift heavy valves by the valve body and pneumatic actuator, not by the control unit (if present)
- Ensure that the pipes are aligned before connecting the valve

8.2 Installation position

The installation position of the diaphragm valve varies depending on the valve body.

Installation for leakage detection



One of the bores in the diaphragm socket, for monitoring leakage, must be at the lowest point.

8.2.1 Installation position 2/2-way valve type 2103

Installation position: any installation position, preferably with the actuator face up.

Installation for self-drainage of the body



It is the responsibility of the installer and operator to ensure self-drainage.

Self-draining must be considered during the installation:

- Inclination angle of the pipeline:

The inclination angle is the responsibility of the installer and operator and should correspond to the inclination angle of the pipeline.

For the pipeline, we recommend the inclination angle according to the valid ASME BPE.

- Self-drainage-angle for valve body:

The self-drainage-angle (α) depends on the valve body size (diaphragm size) and the inner diameter of the port connection (DN).

The self-drainage angle is specified as a value on forged steel valve bodies (VS) and tube valve bodies (VP) (see “Figure 8” and “Figure 9”).

The marking on the port connection of valve bodies serves as an orientation aid (see “Figure 36”). The marking must point upwards.

The actual self-drainage-angle must be set with a suitable measuring tool.

For valve bodies without angle information, you can find the selfdrainage-angle on the Internet.

www.Buerkert.com. Type / User Manuals / Additional manual „Angles for self-draining of diaphragm valves“.

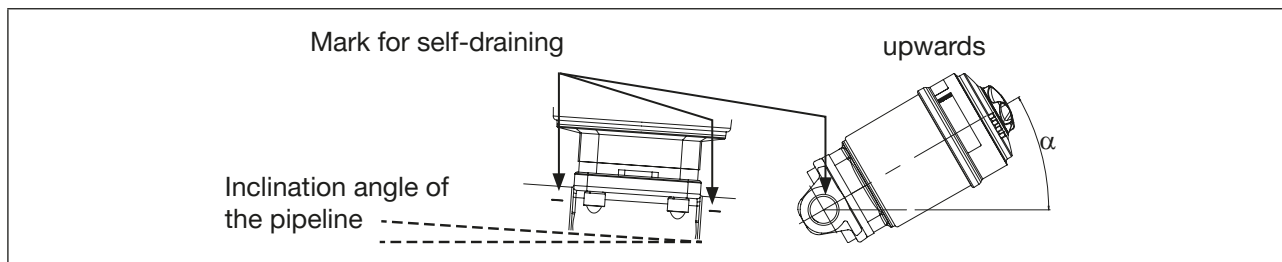

Figure 36: Installation position for self-drainage of the body

If you require clarification, contact your Bürkert sales department.

8.2.2 Installation position T-body type 2104

For the installation of the T-body into circular pipelines, we recommend the following installation positions

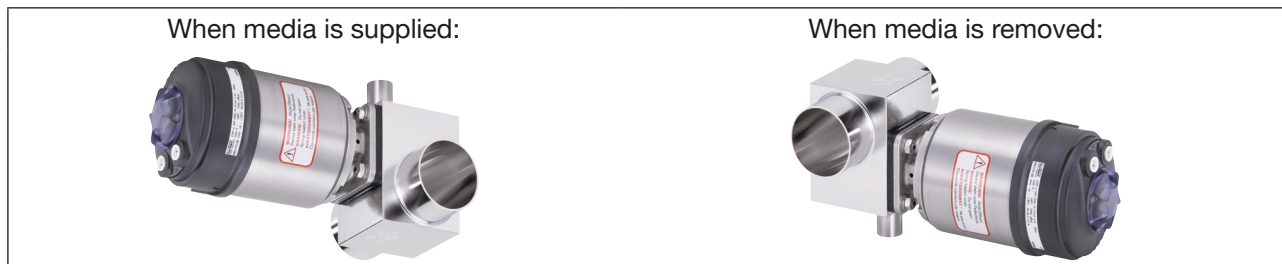

Figure 37: Installation position type 2104

8.2.3 Installation position tank bottom valve type 2105

Installation position: preferably with the actuator to the bottom.



Figure 38: Installation position type 2105

8.3 Before installation

NOTE

Damage to the diaphragm or the actuator.

- ▶ Before welding or gluing the body, the actuator and the diaphragm must be removed.
- Before connecting the valve, ensure the pipelines are aligned.
- The flow direction is optional.

8.3.1 Preparatory work

- Before working on the system or device, switch off the pressure and vent or drain the lines.
- Clean pipelines (sealing material, swarf, etc.).
- Support and align pipelines.

8.4 Remove the actuator from the valve body

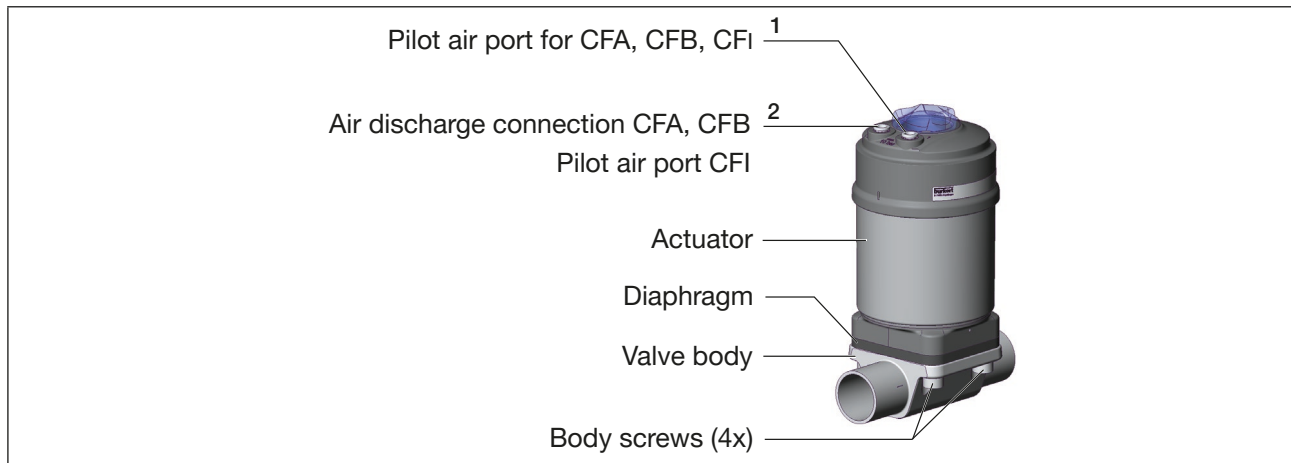

Figure 39: Remove the actuator from the valve body

NOTE

Damage to the diaphragm or the seat contour.

- ▶ When removing the actuator, ensure that the valve is in open position.

- For control function A: pressurize pilot air port **1** with compressed air: valve opens. The minimum pressure values can be found in ["Table 7"](#) in column 0 bar medium.
- Remove 4 or 8 (for DN100) body screws crosswise.
- Remove actuator with diaphragm.

8.5 Installation of the valve body

**WARNING**

Risk of injury from improper installation.

- ▶ Installation may only be performed by qualified and trained personnel.
- ▶ Observe the tightening torque.

8.5.1 Installation 2-way body and T-valve body

Installation requirements:

Pipelines: Ensure that the pipelines are aligned.

Preparation: Support and align pipelines. To ensure that the pipeline is self-draining, we recommend the inclination angle according to the valid ASME BPE.

Valve body with weld or bond connection

- Weld or glue valve body in pipeline system.

Other valve bodies

- Connect body to pipeline.

8.5.2 Welding of the tank bottom body



Recommendations:

Observe the sequence

1. Weld the tank bottom body onto the base of the tank before installing the tank. Welding onto a tank which has already been installed is possible but more difficult. Weld the tank bottom body in the middle of the tank base so that the tank can be optimally drained.
2. Weld tank bottom body into the pipeline.

Installation requirements:

Pipelines: Ensure that the pipelines are aligned.

Preparation: Support and align pipelines. To ensure that the pipeline is self-draining, we recommend the inclination angle according to the valid ASME BPE.

 **DANGER**

Risk of injury from high pressure.

- ▶ Before working on the system, switch off the pressure and vent or drain lines.



For information on tanks and instructions on welding observe the standard ASME VIII Division I.

Before you start welding, check the batch number indicated on the supplied manufacturer's certificate 3.1.



Observe the applicable laws and regulations of the respective country with regard to the qualification of welders and the execution of welding work.

1. Welding tank bottom body onto the tank.

NOTE

Before welding, note the following:

- ▶ Use only welding material which is suitable for the tank bottom body.
- ▶ The tank bottom valve must not collide with any other installation part; the actuator must be easy to install and remove.

2. Welding tank bottom body into the pipeline.

→ Weld in tank bottom body.

 Ensure installation is de-energized and low-vibration.

3. After welding in the valve body:

→ Install the diaphragm and the actuator.

8.6 Installation of the actuator (welded or glued body)

WARNING

For actuator size 225: Risk of crushing when operating the actuator if the compressor is not in the correct position.

Operating the actuator if the compressor is not in the correct position can lead to injuries and damage to the device.

- ▶ Ensure the correct position of the compressor.

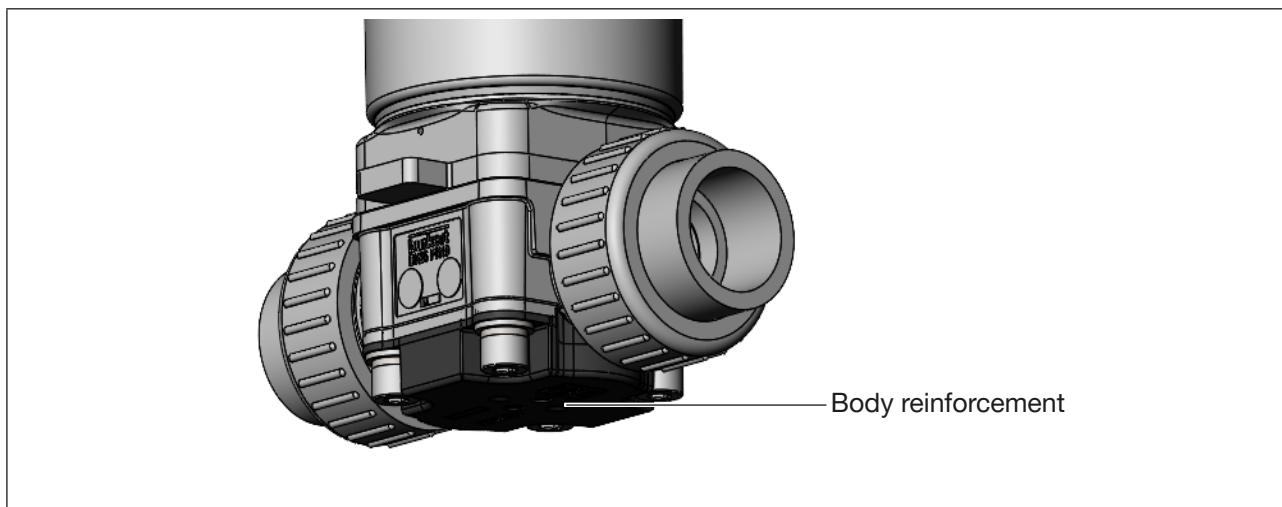

Figure 40: Body reinforcement for PP variants (DN15, DN20, DN25)

NOTE

Do not damage to the diaphragm or the seat contour.

- ▶ When installing the actuator, ensure that the valve is in open position.

Installation for actuator with control function A:

→  For actuator size 225: Ensure the correct position of the compressor (see “Figure 41”).

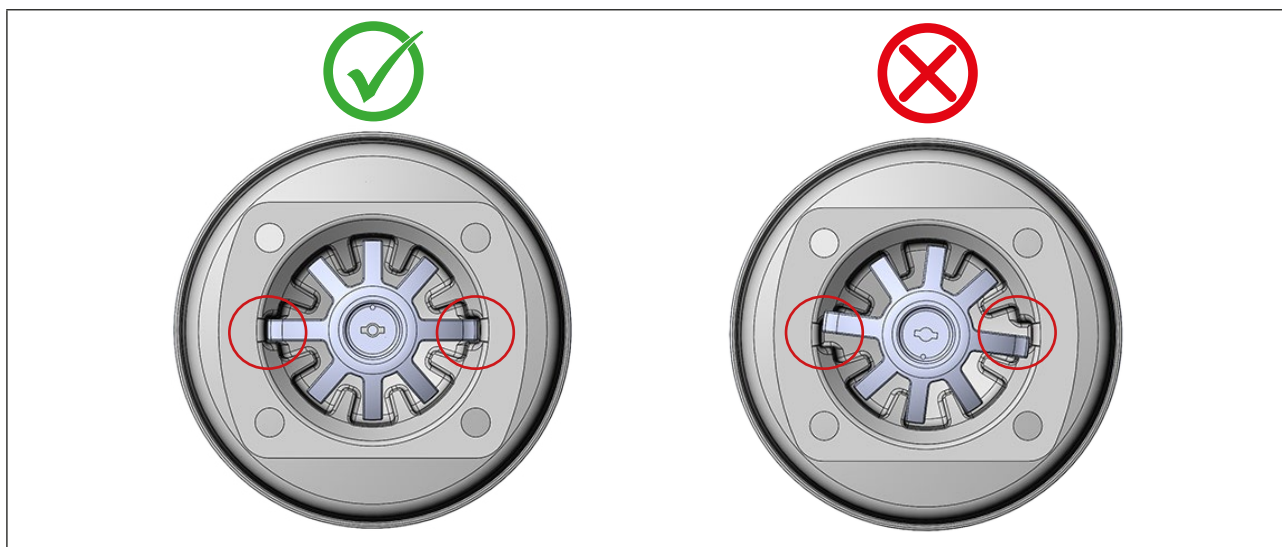

Figure 41: Correct and incorrect position of the compressor

- Pressurize pilot air port 1 with compressed air (5.5 bar).
- Place actuator together with diaphragm on the body.
- For PP variants (DN15, DN20, DN25) the intended body reinforcement is mandatory.
- Lightly **cross-tighten** the body screws until the diaphragm lies between the body and actuator. **Do not tighten the screws yet.**
- Actuate the diaphragm valve twice to position the diaphragm correctly.
- Tighten body screws without pressurization in diagonal pairs in three stages (approx. 1/3, approx. 2/3, 3/3 of the tightening torque), according to table (see “Table 11”). The diaphragm should be positioned and pressed evenly all around the actuator and body.

Installation for actuator with control functions B and I:

- Place actuator together with diaphragm on the body.
- For PP variants (DN15, DN20, DN25) the intended body reinforcement is mandatory.
- Lightly **cross-tighten** the body screws without pressurization until the diaphragm lies between the body and actuator. **Do not tighten the screws yet.**
- Pressurize pilot air port 1 with compressed air (5.5 bar).
- Actuate the diaphragm valve twice to position the diaphragm correctly.
- Tighten body screws with pressurization in diagonal pairs in three stages (approx. 1/3, approx. 2/3, 3/3 of the tightening torque), according to Table (see “Table 11”). The diaphragm should be positioned and pressed evenly all around the actuator and body.

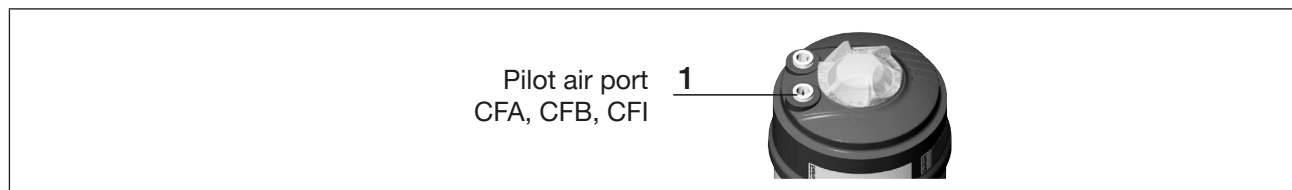

Figure 42: Pilot air port

Diaphragm size	Tightening torques ⁴⁾ [Nm]			
	VS, VG, PP, PVC-C, PVC-U, PVDF		VP	
	EPDM/FKM	PTFE	EPDM/FKM	PTFE
8	2	2,5	2	2,5
15	3,5	4	3,5	4
20	4	4,5	4	4,5
25	5	6	7	8
32	6	8	8	10
40	8	10	12	15
50	12	15	15	20
65	20	30	20	30
80	30	40	30	40
100	40	50	40	50

Table 11: Tightening torques for installation of the actuator

⁴⁾ A tolerance of +10% of the respective tightening torque applies to all values.

8.7 Align actuator



If valves feature a VA diaphragm socket, the actuator for the valve body can be rotated steplessly by 360 ° (VA = stainless steel).

→ Rotate actuator using a hook wrench. Rotate actuator only as far as required (max. 360 °).

Recommended
hook wrenches as
per DIN 1810.

Actuator size:

ø 50 = A 52 - 55,

ø 70 - 130 = A 68 - 75

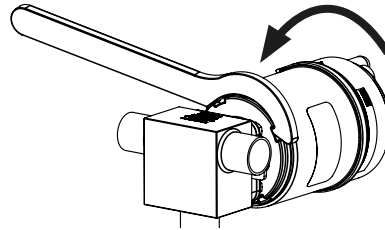

Figure 43: Align actuator

For actuator size 225:

→ Place the open-end wrench SW41 on the hexagon of the actuator base.

→ Move the actuator to the desired position.

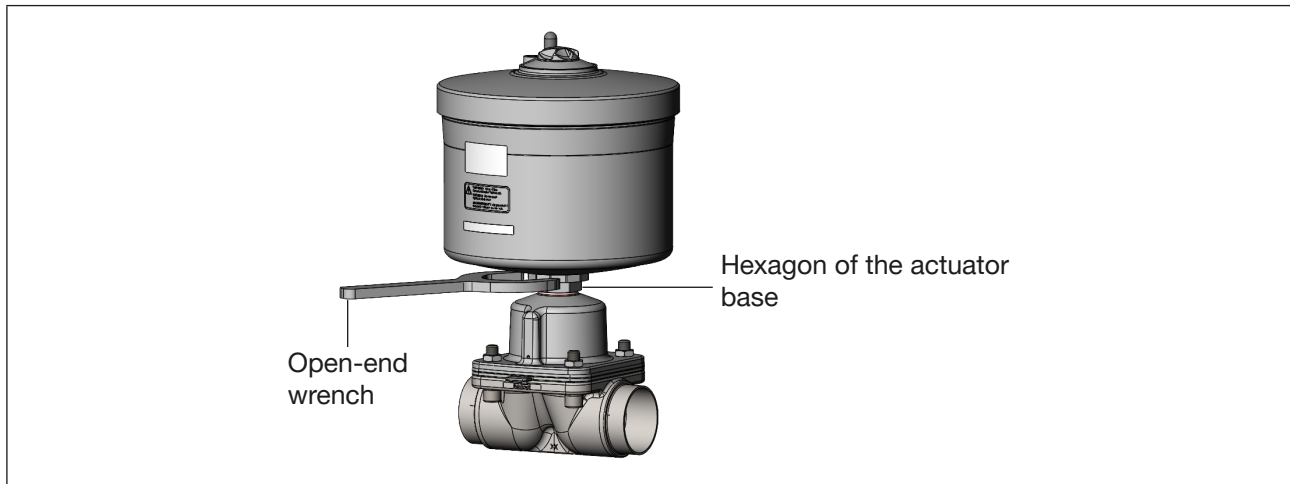

Figure 44: Align actuator for actuator size 225

8.8 Pneumatic connection

WARNING

Risk of injury from unsuitable connection hoses.

- ▶ Use only hoses which are authorized for the indicated pressure and temperature range.
- ▶ Observe the data sheet specifications from the hose manufacturers.

For control function I – Danger if pilot pressure fails.

For control function I control and resetting occur pneumatically. If the pressure fails, no defined position is reached.

- ▶ To ensure a controlled restart, first pressurize the device with pilot pressure, then switch on the medium.

8.8.1 Connection of the control medium

Control functions A and B:

→ Connect the control medium to the pilot air port 1 of the actuator (see “Figure 45”).

Control function A, 3-position actuator:

→ Connect the control medium to the pilot air port 1 and 2 of the actuator (see “Figure 45”).
Pressure on pilot air port 1 opens the valve.
Pressure on pilot air ports 1 and 2 sets the valve in the center position.

Control function I:

→ Connect the control medium to the pilot air port 1 and 2 of the actuator (see “Figure 45”).
Pressure on pilot air port 1 opens the valve.
Pressure on pilot air port 2 closes the valve.



If used in an aggressive environment, we recommend conveying all free pneumatic connections into a neutral atmosphere with the aid of a pneumatic hose.

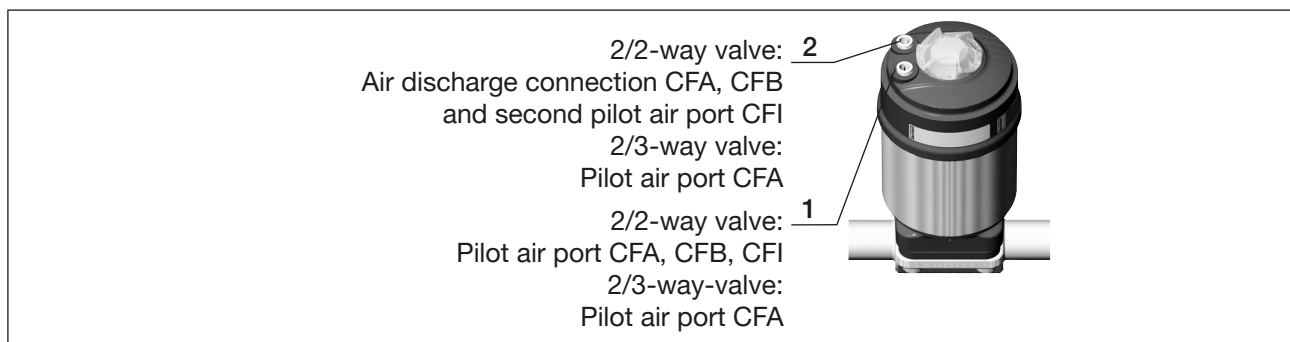

Figure 45: Pneumatic connection

Silencer

For the versions with a plug-in connection the silencer for reducing the exhaust air noise is supplied loose.

→ Plug the silencer into the free air discharge connection 2 (see “Figure 45: Pneumatic connection”).

Control air hose

Control air hoses of sizes 6/4 mm or 1/4“ can be used. Optionally a pilot air port is possible via a G 1/8 thread.

8.9 Removal



DANGER!

Risk of injury from discharge of medium and pressure.

It is dangerous to remove a device which is under pressure due to the sudden release of pressure or discharge of medium.

- ▶ Before removing a device, switch off the pressure and vent the lines.

→ Loosen the pneumatic connection.

→ Remove the device.

9 ELECTRICAL CONTROL UNIT

The valve Type 2103, 2104 and 2105 can be combined with following control units:

- Type 8690 Pneumatic control unit (actuator size Ø 70 - Ø 225)
- Type 8697 Pneumatic control unit (actuator size Ø 50)
- Type 8691 Control head (actuator size Ø 70 - Ø 225)
- Type 8695 Control head (actuator size Ø 50)
- Type 8692 Positioner (actuator size Ø 70 - Ø 225)
- Type 8693 Process controller (actuator size Ø 70 - Ø 225)
- Type 8694 Positioner (actuator size Ø 70 - Ø 225)
- Type 8696 Positioner (actuator size Ø 50)



The electrical connection of the pilot valve or the control is described in the respective operating instructions for the pilot valve/control.

10 MAINTENANCE

DANGER

Danger – high pressure in the equipment.

- ▶ Before loosening the lines and valves, turn off the pressure and vent the lines.

Risk of injury due to electrical shock.

- ▶ Before reaching into the system, switch off the power supply and secure to prevent reactivation.
- ▶ Observe applicable accident prevention and safety regulations for electrical equipment.

WARNING

Risk of injury from improper maintenance.

- ▶ Maintenance may be performed by authorised technicians only and with the appropriate tools..

Risk of injury from unintentional activation of the system and an uncontrolled restart!

- ▶ Secure system from unintentional activation.
- ▶ Following maintenance, perform a controlled restart.

10.1 Maintenance

10.1.1 Actuator

The actuator of the diaphragm valve is maintenance-free provided it is used according to these operating instructions.

10.1.2 Wearing parts of the diaphragm valve

Parts which are subject to natural wear:

- Seals
- Diaphragm

→ If leaks occur, replace the particular wearing part with an appropriate spare part (see chapter entitled [“13 Replacement parts”](#)).

→ Periodic control of the relief bore (see [“Figure 46”](#))

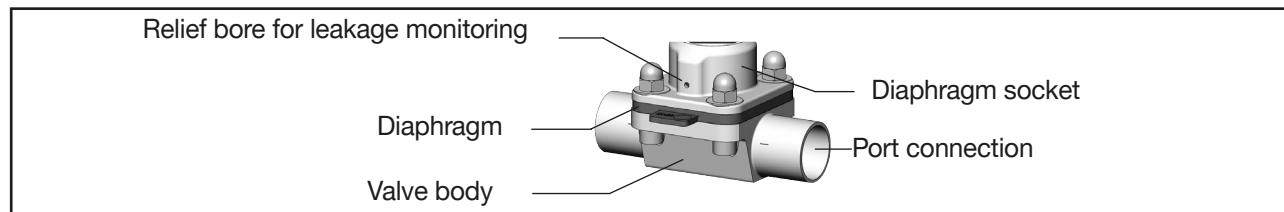

Figure 46: Relief bore



A bulging PTFE diaphragm may reduce the flow.



The replacing of the wearing parts is described in chapter [“11 Replacing the diaphragm”](#).

10.1.3 Inspection intervals

The following maintenance work is required for the diaphragm valve:

- After the first steam sterilization or when required retighten body screws crosswise.
- After maximum 10⁵ switching cycles check the diaphragm for wear and replace if required.



Muddy and abrasive media require correspondingly shorter inspection intervals.

10.1.4 Visual inspection

Perform regular visual inspections according to the conditions of use:

- Check medium connections for leak-tightness.
- Check relief bores for leaks.

10.1.5 Service life of the diaphragm

The service life of the diaphragm depends on the following factors:

- Diaphragm material
- Medium
- Medium pressure
- Medium temperature
- Actuator size
- Pilot pressure for CFB and CFI.

Protecting the diaphragm

- For CFA match the actuator size (actuator force) to the medium pressure to be actuated. If required, select the actuator with reduced spring force EC04.
- For CFB and CFI try and select the pilot pressure not higher than is required to actuate the medium pressure.

10.1.6 Cleaning

Commercially available cleaning agents can be used to clean the outside.

NOTE

Avoid causing damage with cleaning agents.

- ▶ Before cleaning, check that the cleaning agents are compatible with the body materials and seals.

11 REPLACING THE DIAPHRAGM



DANGER

Risk of injury from discharge of medium and pressure.

It is dangerous to remove a device which is under pressure due to the sudden release of pressure or discharge of medium.

- ▶ Before removing a device, switch off the pressure and vent the lines.
- ▶ Completely drain the lines.
- ▶ During reinstallation check tightening torque of the body screws.

Fastening types

Diaphragm size	Fastening types for diaphragms	
	PTFE	EPDM / FKM / laminated PTFE
8	Diaphragm buttoned	Diaphragm buttoned
15, 20	Diaphragm with bayonet catch	Diaphragm with bayonet catch
25, 32, 40, 50, 65, 80, 100	Diaphragm with bayonet catch	Diaphragm with threaded connection

Table 12: Fastening types for diaphragms

11.1.1 Replacement of the diaphragm for control function A

→ Clamp the valve body in a holding device (applies only to valves not yet installed).

NOTE

Damage to the diaphragm or the seat contour.

- ▶ When removing the actuator, ensure that the valve is in open position.

→ Pressurize pilot air port 1 with compressed air: valve opens.

The minimum pressure values can be found in "Table 7" in column 0 bar medium.

→ Loosen the four body screws crosswise.

→ Remove the actuator together with diaphragm from the body.

→ Unbutton or unscrew the old diaphragm. If attachment is with a bayonet catch, remove the diaphragm by rotating it through 90°. For orifice DN25-DN50 observe chapter "11.1.3".

→ Install new diaphragm.

→ Align diaphragm. The mark tab of the diaphragm must be perpendicular to the direction of flow (see "Figure 47").

NOTE

For diaphragms with threaded connection:

If the pin is live, the diaphragm may be damaged.

- ▶ First screw on the diaphragm hand-tight, then loosen it by one-half turn counterclockwise.

! WARNING

For actuator size 225: Risk of crushing when operating the actuator if the compressor is not in the correct position.

Operating the actuator if the compressor is not in the correct position can lead to injuries and damage to the device.

- ▶ Ensure the correct position of the compressor.

→ **!** For actuator size 225: Ensure the correct position of the compressor(see [“Figure 41”](#)).

→ Place actuator together with diaphragm back on the body.

For PP variants (DN15, DN20, DN25) the intended body reinforcement is mandatory.

→ Insert the body screws and lightly cross-tighten until the diaphragm lies between the body and actuator.
Do not tighten the screws yet.

→ Actuate the diaphragm valve twice to position the diaphragm correctly.

→ Tighten body screws without pressurization in diagonal pairs in three stages (approx. 1/3, approx. 2/3, 3/3 of the tightening torque), according to table (see [“Table 13”](#)). The diaphragm should be positioned and pressed evenly all around the actuator and body.

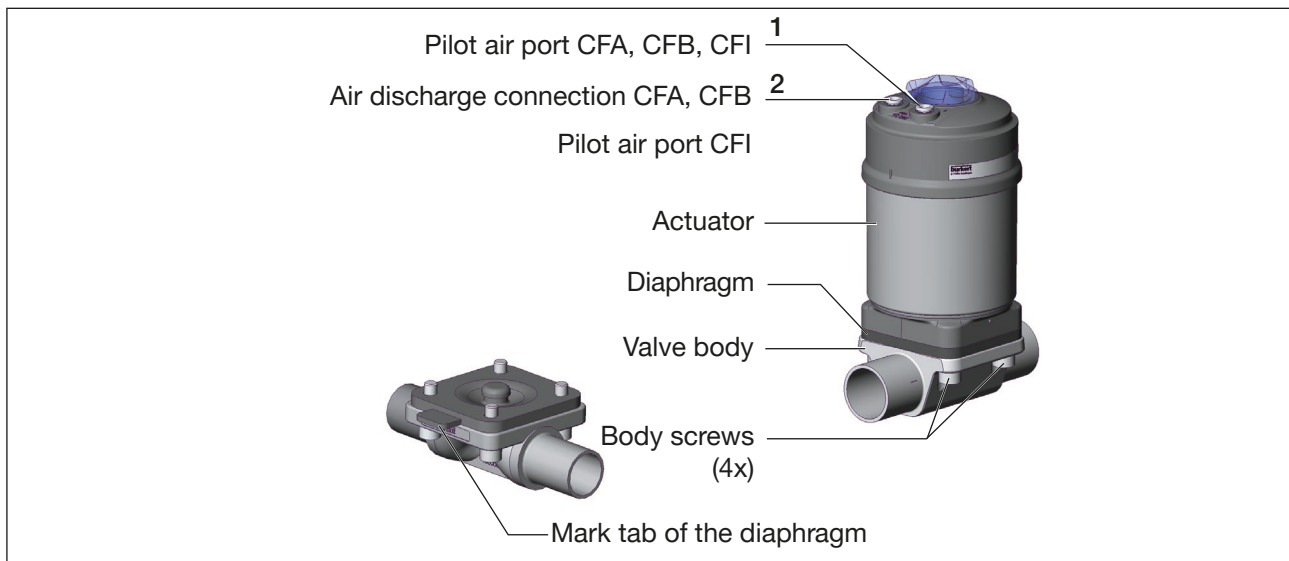

Figure 47: Replacing the diaphragm

11.1.2 Replacement of the diaphragm for control function B and I

→ Clamp the valve body in a holding device (applies only to valves not yet installed).

→ Loosen the four body screws crosswise.

→ Remove the actuator together with diaphragm from the valve body.

→ Unbutton or unscrew the old diaphragm. If attachment is with a bayonet catch, remove the diaphragm by rotating it through 90°. For orifice DN25-DN50 observe chapter [“11.1.3”](#).

→ Install new diaphragm.

→ Align diaphragm. The mark tab of the diaphragm must be perpendicular to the direction of flow (see “Figure 47”).

NOTE

For diaphragms with threaded connection:

If the pin is live, the diaphragm may be damaged.

▶ First screw on the diaphragm hand-tight, then loosen it by one-half turn counterclockwise.

→ Place actuator together with diaphragm back on the body.

For PP variants (DN15, DN20, DN25) the intended body reinforcement is mandatory.

→ Lightly cross-tighten the body screws without pressurization until the diaphragm lies between the body and actuator. **Do not tighten screws yet.**

→ Pressurize pilot air port 1 with compressed air (5 bar).

→ Actuate the diaphragm valve twice to position the diaphragm correctly.

→ Tighten body screws with pressurization in diagonal pairs in three stages (approx. 1/3, approx. 2/3, 3/3 of the tightening torque), according to table (see “Table 13”). The diaphragm should be positioned and pressed evenly all around the actuator and body.

Diaphragm size	Tightening torques ⁵⁾ [Nm]			
	VS, VG, PP, PVC-C, PVC-U, PVDF		VP	
	EPDM/FKM	PTFE	EPDM/FKM	PTFE
8	2	2,5	2	2,5
15	3,5	4	3,5	4
20	4	4,5	4	4,5
25	5	6	7	8
32	6	8	8	10
40	8	10	12	15
50	12	15	15	20
65	20	30	20	30
80	30	40	30	40
100	40	50	40	50

Table 13: Tightening torques for diaphragms

⁵⁾ A tolerance of +10% of the respective tightening torque applies to all values.

11.1.3 Switch between PTFE and EPDM diaphragms

1. Changing the diaphragm for diaphragm size 8:

→ Detach PTFE diaphragm and attach new EPDM diaphragm (or vice versa).

2. Changing the diaphragm for diaphragm size 5 and 20:

→ Loosen PTFE diaphragm bayonet and attach new EPDM diaphragm (or vice versa).

3. Changing the diaphragm for diaphragm size 25 up to 50:

→ Loosen PTFE diaphragm by turning it 90°.

→ Place the insert in the compressor.

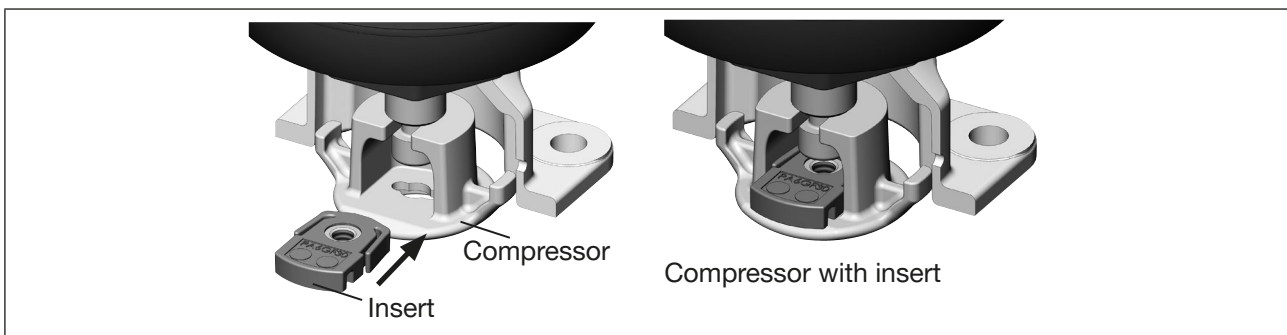

Figure 48: Place the insert in compressor

→ Insert and screw in EPDM diaphragm.

NOTE

For diaphragms with threaded connection:

If the pin is live, the diaphragm may be damaged.

- ▶ First screw on the diaphragm hand-tight, then loosen it by one-half turn counterclockwise.

Changing the EPDM diaphragm to a PTFE diaphragm:

→ Unscrew the EPDM diaphragm.

→ Remove the insert from the compressor.

NOTE

For diaphragm with bayonet connection:

If the insert is not removed, a diaphragm with bayonet connection can still be fitted. This can severely damage the diaphragm and valve body.

→ Insert the PTFE membrane and fix it by turning it through 90°.

12 MALFUNCTIONS

Malfunction	Cause and remedial action
Actuator does not switch	Pilot air port interchanged CFA: (2/2-way valve) Connecting pilot air port 1
	CFA: (2/3-way valve) Pilot air port 1: Open Pilot air port 2: Center position
	CFB: Connecting pilot air port 1
	CFI: Pilot air port 1: Open Pilot air port 2: Close
	Pilot pressure too low See pressure specifications on the type label.
	Medium pressure too high See pressure specifications on the type label.
Valve is not sealed	Medium pressure too high See pressure specifications on the type label.
	Pilot pressure too low See pressure specifications on the type label.
Flow rate reduced	PTFE diaphragm bulging → Replace diaphragm

Table 14: Malfunctions

13 REPLACEMENT PARTS

CAUTION

Risk of injury and/or damage by the use of incorrect parts.

Incorrect accessories and unsuitable replacement parts may cause injuries and damage the device and the surrounding area.

► Use only original accessories and original replacement parts from Bürkert.

The diaphragm is available as a replacement part for the piston-controlled diaphragm valve Type 2103, 2104 and 2105.

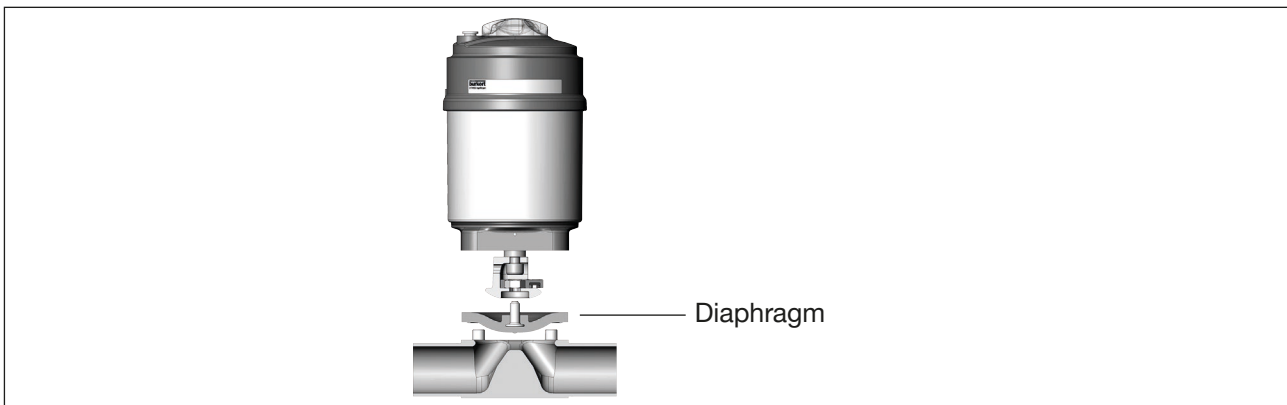

Figure 49: Diaphragm replacement part

13.1 Diaphragm

Replacement diaphragms can be ordered according to the table below. The diaphragms are marked with a material code that specifies them. The material code is located on the identification tab or, in the case of two-piece diaphragms, on the tab of the support diaphragm and the diaphragm plate. The material code may differ for older materials.

Diaphragm size	EPDM (AD*)		FKM (FF*)	
	Order number	Material code	Order number	Material code
8	688 421	EPDM E03/E04	677 684	FKM F01
15	688 422	EPDM E03/E04	677 685	FKM F01
15 BC**	693 163	EPDM E03/E04	693 164	FKM F01
20	688 423	EPDM E03/E04	677 686	FKM F01
20 BC**	693 166	EPDM E03/E04	693 167	FKM F01
25	688 424	EPDM E03/E04	677 687	FKM F01
32	688 425	EPDM E03/E04	677 688	FKM F01
40	688 426	EPDM E03/E04	677 689	FKM F01
50	688 427	EPDM E03/E04	677 690	FKM F01
65	688 428	EPDM E03/E04	677 691	FKM F01
80	688 429	EPDM E03/E04	677 692	FKM F01
100	688 430	EPDM E03/E04	677 693	FKM F01

Table 15: Order numbers for EPDM and FKM diaphragms

Diaphragm size	PTFE (EA*)		Advanced PTFE (EU*)		GYLON® laminated (ER*)	
	Order number	Material code	Order number	Material code	Order number	Material code
8	677 674	PTFE L04/L10	679 540	PTFE L05/L09	693 175	PTFE L06/L08
15	677 675	EPDM E02/E04 / PTFE P01	679 541	EPDM E02/E04 / PTFE P02 or hole	693 176	PTFE L06/L08
20	677 676	EPDM E02/E04 / PTFE P01	679 542	EPDM E02/E04 / PTFE P02 or hole	693 177	PTFE L06/L08
25	677 677	EPDM E02/E04 / PTFE P01	679 543	EPDM E02/E04 / PTFE P02 or hole	693 178	PTFE L06/L08
32	677 678	EPDM E02/E04 / PTFE P01	679 544	EPDM E02/E04 / PTFE P02 or hole	693 179	PTFE L06/L08
40	584 378	EPDM E02/E04 / PTFE P01	584 379	EPDM E02/E04 / PTFE P02 or hole	693 180	PTFE L06/L08
50	584 386	EPDM E02/E04 / PTFE P01	584 387	EPDM E02/E04 / PTFE P02 or hole	693 181	PTFE L06/L08
65	20047938	EPDM E02/E04 / PTFE P01	20047940	EPDM E02/E04 / PTFE P02 or hole	586 616	PTFE L08
80	20047939	EPDM E02/E04 / PTFE P01	20047941	EPDM E02/E04 / PTFE P02 or hole	-	-
100	677 683	EPDM E02/E04 / PTFE P01	679 745	EPDM E02/E04 / PTFE P02 or hole	-	-

Table 16: Order numbers for PTFE and GYLON® diaphragms

* SAP Code



If you have any queries, please contact your Bürkert sales office.

14 PACKAGING, TRANSPORT

CAUTION

Risk of injury due to a heavy device.

A heavy device can fall down during transport or during installation and cause injuries.

- ▶ Transport, install and dismantle a heavy device with the help of another person.
- ▶ Use appropriate tools.

NOTE

Transport damages.

Inadequately protected equipment may be damaged during transport.

- ▶ During transportation protect the device against wet and dirt in shock-resistant packaging.
- ▶ Avoid exceeding or dropping below the permitted storage temperature.

15 STORAGE

NOTE

Incorrect storage may damage the device.

- ▶ Store the device in a dry and dust-free location.
- ▶ Storage temperature $-20...+65$ °C.

16 DISPOSAL



- ▶ Follow national regulations regarding disposal and the environment.
- ▶ Collect electrical and electronic devices separately and dispose of them as special waste.

Weitere Informationen unter country.burkert.com

