

## Type SE30 Ex

Electronic flowmeter for explosive atmospheres



### Operating Instructions

Bedienungsanleitung  
Manuel d'utilisation

We reserve the right to make technical changes without notice.

Technische Änderungen vorbehalten.

Sous réserve de modification technique.

[www.burkert.com](http://www.burkert.com)

© Bürkert SAS, 2013 - 2018

Operating Instructions 1803/02\_EU-ml 00553593

MAN 1000351957 EN Version: - Status: RL (released | freigegeben) printed: 16.03.2018

1. ABOUT THE OPERATING INSTRUCTIONS.....	3
2. INTENDED USE.....	5
3. BASIC SAFETY INFORMATION .....	6
4. GENERAL INFORMATION .....	9
5. ATEX INSTRUCTIONS NOTICE.....	10
6. DESCRIPTION.....	13
7. TECHNICAL DATA .....	16
8. INSTALLATION AND COMMISSIONING.....	19
9. WIRING.....	23
10. MAINTENANCE.....	30
11. ACCESSORIES.....	32
12. PACKAGING, TRANSPORT .....	33
13. STORAGE .....	34
14. DISPOSAL.....	34

## 1. ABOUT THE OPERATING INSTRUCTIONS

The Operating Instructions describe the entire life cycle of the device. Please keep the Operating Instructions in a safe place, accessible to all users and any new owners.

**The Operating Instructions contain important safety information.**

Failure to comply with these instructions can lead to hazardous situations.

- The Operating Instructions must be read and understood.

### Symbols used



#### DANGER

Warns against an imminent danger.

- Failure to observe this warning results in death or in serious injury.



#### WARNING

Warns against a potentially dangerous situation.

- Failure to observe this warning can result in serious injury or even death.

**ATTENTION****Warns against a possible risk.**

- Failure to observe this warning can result in substantial or minor injuries.

**ATEX**

Indicates ATEX important information or safety instructions.

**NOTE****Warns against material damage.**

- Failure to observe this warning may result in damage to the device or system.



Indicates additional information, advice or important recommendations.



Refers to information contained in the Operating Instructions or in other documents.

→ Indicates a procedure to be carried out.

**Definition of the word "device"**

The word "device" used in the Operating Instructions refers to the electronic flowmeter type SE30 Ex.

4

English

**2. INTENDED USE****Use of the device that does not comply with the instructions could present risks to people, nearby installations and the environment.**

The SE30 Ex electronic flowmeter is intended for measuring the flow rate in neutral or slightly aggressive liquids that have no solid particles, in explosive areas (see chap. 5).

- Use the device only in combination with foreign instruments or foreign components recommended or approved by Bürkert.
- Protect the device against electromagnetic interference, ultraviolet rays and, when installed outdoors, the effects of climatic conditions.
- Use the device in compliance with the characteristics and commissioning and use conditions specified in the contractual documents and in the Operating Instructions.
- Store, transport, install and operate the device properly.
- Only operate a device in perfect working order.
- Only use the device as intended.

English

5

**3. BASIC SAFETY INFORMATION**

This safety information does not take into account any contingencies or occurrences that may arise during installation, use and maintenance of the device.

The operating company is responsible for the respect of the local safety regulations including for the staff safety.

**Risk of injury due to electrical voltage.**

- Shut down the electrical power source of all the conductors and isolate it before carrying out work on the system.
- Observe all applicable accident protection and safety regulations for electrical equipment.

**Risk of injury due to high pressure in the installation.**

- Stop the circulation of fluid, cut off the pressure and drain the pipe before loosening the process connections.
- Observe the dependency between the fluid temperature and the fluid pressure.

**Risk of injury due to high fluid temperatures.**

- Use safety gloves to handle the device.
- Stop the circulation of fluid and drain the pipe before loosening the process connections.

6

English

**Risk of injury due to the nature of the fluid.**

- Respect the prevailing regulations on accident prevention and safety relating to the use of dangerous fluids.

**Various dangerous situations**

To avoid injury:

- To use the device in an explosive atmosphere, observe the specifications given on the rating plate.
- To use the device in an explosive atmosphere, observe the additional information and the safety instructions given in [5. ATEX instructions notice](#).
- Do not use the device in an environment incompatible with the materials it is made of.
- Do not use fluid that is incompatible with the materials the device is made of.
- Do not subject the device to mechanical stress.
- Do not make any modifications to the device.
- Prevent any unintentional power supply switch-on.
- Only qualified and skilled staff can carry out the installation and maintenance work.
- Guarantee a defined or controlled restarting of the process, after a power supply interruption.

English

7



### Various dangerous situations

To avoid injury:

- Observe the general technical rules.

### NOTE

#### The device may be damaged by the fluid in contact with.

- Systematically check the chemical compatibility of the component materials of the device and the fluids likely to come into contact with it (for example: alcohols, strong or concentrated acids, aldehydes, alkaline compounds, esters, aliphatic compounds, ketones, halogenated aromatics or hydrocarbons, oxidants and chlorinated agents).

## 4. GENERAL INFORMATION

To contact the manufacturer of the device, use following address:

Bürkert SAS

Rue du Giessen

BP 21

F-67220 TRIEMBACH-AU-VAL

The addresses of our international sales offices are available on the internet at: [www.buerkert.com](http://www.buerkert.com)

### Information on the Internet

You can find the Operating Instructions and technical data sheets regarding the type SE30 Ex at: [www.buerkert.com](http://www.buerkert.com)

## 5. ATEX INSTRUCTIONS NOTICE

### Area of application

The flowmeter type SE30 Ex is intended for measuring the flow rate in neutral or slightly aggressive liquids that have no solid particles, and in the following explosive areas:

- areas 0, 1 or 2 and areas 20, 21, 22 category II 1G/D appliance

#### Model SE30 Ex NAMUR with article number 552901, for potentially explosive areas of gas (0, 1 and 2) and/or dust (20, 21 and 22)

- Helps with understanding the marking and with installation:

CE 0102  II 1 GD  
 Ex ia IIC T6  
 Ex iaD 20 IP6X T80°C  
 T ambient: 0 °C ≤ Ta ≤ 60 °C  
 LCIE 04 ATEX 6070 X

- Special conditions for safe use:
  - The equipment is an appliance that is intrinsically safe.
  - It may be installed in potentially explosive atmospheres: areas 0, 1 or 2 and areas 20, 21 or 22.
  - The connector only has to be connected to an appliance that has the intrinsic safety certification. These

connections must be compatible as regards intrinsic safety and comply with the following parameters.

- Ambient temperature for use: 0°C...+60°C
- Special parameters of relevant protection method/s: U<sub>i</sub> ≤ 15V, I<sub>i</sub> ≤ 50 mA, P<sub>i</sub> ≤ 188 mW, C<sub>i</sub> ≤ 1,2 nF, L<sub>i</sub> ≅ 0
- Mechanical assembly and fluid connections that are compatible with said marking and said use: Use only brass, stainless steel, aluminium or PVDF sensor-fittings.

**If the sensor-fitting has a PP paddle-wheel, make sure there is no risk of explosion within the pipe: the fluidics must be within the safe area.**

- Any other sensor-fittings are prohibited in explosive areas.

### Warranty and liability

During the warranty period and outside said period the Bürkert company alone is authorised to carry out repairs or alterations to any of its devices that has been awarded EU type examination certification. Bürkert disclaims its liability in the event of non-compliance with this clause.



The assembly work must be carried out by qualified personnel. In the event of problems with installation or commissioning, please contact your Bürkert supplier as soon as possible.

## Traceability

The SE30 Ex devices are identified by an individual batch number which allows them to be traced. This number (5 figures), plus the year, is inscribed on a rating plate bearing the article number of the device.

This device is an appliance for potentially explosive atmospheres. In this regard and in compliance with the 2014/34/EU ATEX Directive, provisions must be made to ensure ascending and descending traceability. Our ATEX notified quality system ensures this traceability up to the initial point of delivery.

Except as otherwise agreed in writing, anyone that guarantees to redeliver said equipment undertakes to put in place a system that allows for equipment that is not conform to be recalled if necessary.

## Safety instructions

**Use of the device that does not comply with the instructions could present risks to people, nearby installations and the environment.**

- The device must be protected against electromagnetic interference, ultraviolet rays and, when installed outdoors, the effects of climatic conditions.
- When the flowmeter is disassembled from the pipe, take all the precautions associated with the process.



ATEX

Said appliance must be installed in accordance with the provisions of standard EN 60079-14: electrical appliance for potentially explosive atmospheres.

Part 14: electrical installations in dangerous sites (other than mines).

## 6. DESCRIPTION

### Construction

The device is a transmitter which must be associated to a measuring element, either a sensor-fitting type S030 (brass, stainless steel or PVDF), a sensor-fitting type S070 or a sensor-fitting type S077.



ATEX

Depending on its place of use the SE30 Ex flowmeter must be connected according to the safety instructions of chap. 5.

The device:

- is energized through an intrinsic safety barrier;
- has a Namur output.

Electrical connection is made over a male connector according to EN 175301-803.

### Measuring principle

The sensor detects the rotation of the paddle-wheel and modulates the current of the supply line as per the Namur standard (0.5 mA or 2.5 mA). The modulation frequency  $f$  is proportional to the flow rate  $Q$  using the formula  $f = KxQ$ .

$f$  = frequency in Hz

$K$  = factor  $K$  specific to each sensor-fitting, in pulse/l

$Q$  = flow rate in l/s

In order to exploit this signal, connect a Namur type intrinsic safety barrier to the SE30 Ex. It detects the modulation and converts it to a frequency on its open collector output.

### Description of the rating plate

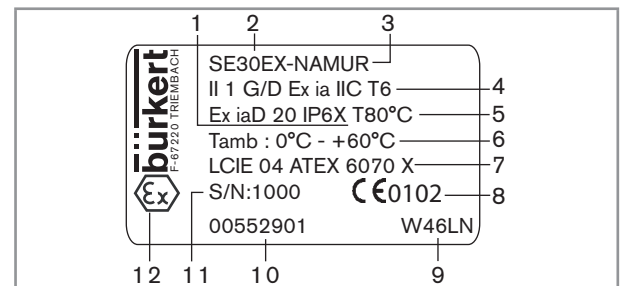

1. Protection rating
2. Type of flowmeter
3. Type of supply/output
4. ATEX classification
5. Maximum surface temperature
6. Ambient operating temperature
7. Certification body and ATEX number
8. CE conformity logo – Code of notified body that inspected the site
9. Manufacturing code and manufacturing year code
10. Article number
11. Serial number
12. Conformity logo

## 7. TECHNICAL DATA

### Conditions of use

Ambient temperature (operating)	0 °C...+60 °C
Air humidity	< 80%, non condensated
Protection rating according to EN60529	IP 67, connector plugged-in and cable gland tightened

### Fluid and measurement data

Pipe diameter	<ul style="list-style-type: none"> <li>▪ with sensor-fitting type S030</li> <li>▪ with sensor-fitting type S070 or type S077</li> </ul>	<ul style="list-style-type: none"> <li>▪ DN6...DN65</li> <li>▪ DN15...DN50</li> </ul>
Fluid temperature	max. 80 °C	
Flow rate measuring range with sensor-fitting type S030	0,5...1500 l/h (velocity: 0,3...10 m/s)	
Flow rate measuring range with sensor-fitting type S070 or type S077	<ul style="list-style-type: none"> <li>▪ viscosity &gt; 5 cps</li> <li>▪ viscosity &lt; 5 cps</li> </ul>	
	<ul style="list-style-type: none"> <li>▪ 2...350 l/min</li> <li>▪ 3...300 l/min</li> </ul>	

16

English

Measurement deviation, with a sensor-fitting type S030	<ul style="list-style-type: none"> <li>▪ ±1% of the measured value (at the teach-in flow rate) *, with calibration on site (e.g. using Teach-in feature of a transmitter type 8025, remote version)</li> <li>▪ ±2,5% of the measured value*, with standard K factor</li> </ul>
Measurement deviation, with a sensor-fitting type S070 or type S077	±0,5% of the measured value
Linearity	±0,5% of the full scale *
Repeatability	<ul style="list-style-type: none"> <li>▪ with sensor-fitting type S030</li> <li>▪ with sensor-fitting type S070 or type S077</li> </ul>
	<ul style="list-style-type: none"> <li>▪ ±0,4% of the measured value *</li> <li>▪ ±0,3% of the measured value *</li> </ul>

\* Determined in the following reference conditions: medium = water, water and ambient temperatures 20 °C, min. upstream and downstream distances respected, appropriate pipe dimensions

English

17

### Materials

Part	Material
Housing, cover	PPS, glass fibre reinforced
Connector	PA, with silicone seal
Sensor-fitting type S030, S070, S077	refer to the Operating Instructions of the sensor-fitting used and the ATEX limitations given in chap. 5.

### Electrical data

Power supply: see chap. 5 to choose the appropriate power supply according to the place of use	II 1 G/D version: supplied by the intrinsic safety barrier with NAMUR input (DIN 60947-5-6)
Current consumption	7 mA max.
Reversed polarity	protected
Output signal	0.5 or 2.5 mA, through both supply wires, current modulation according to NAMUR standard

### Dimensions

→ Refer to the technical data sheet type SE30 available at: [www.buerkert.com](http://www.buerkert.com)

18

English

## 8. INSTALLATION AND COMMISSIONING

### Safety instructions



#### DANGER

#### Risk of injury due to electrical voltage.

- Shut down the electrical power source of all the conductors and isolate it before carrying out work on the system.
- Observe all applicable accident protection and safety regulations for electrical equipment.

#### Risk of injury due to high pressure in the installation.

- Stop the circulation of fluid, cut off the pressure and drain the pipe before loosening the process connections.
- Observe the dependency between the fluid temperature and the fluid pressure.

#### Risk of injury due to high fluid temperatures.

- Use safety gloves to handle the device.
- Stop the circulation of fluid and drain the pipe before loosening the process connections.

#### Risk of injury due to the nature of the fluid.

- Respect the prevailing regulations on accident prevention and safety relating to the use of dangerous fluids.

English

19

**! WARNING**

**Risk of injury due to non-conforming installation.**

- The electrical and fluid installation can only be carried out by qualified and skilled staff with the appropriate tools.
- Observe mounting instructions of the sensor-fitting.

**Risk of injury due to an uncontrolled restart.**

- Ensure that the restart of the installation is controlled after any interventions on it.

**! WARNING**

**Risk of injury due to non-conforming commissioning.**

Non conforming commissioning may lead to injuries and damage the device and its surroundings.

- Before commissioning, make sure that the staff in charge have read and fully understood the contents of the Operating Instructions.
- In particular, observe the safety recommendations and intended use.
- The device / the installation must only be commissioned by suitably trained staff.

**NOTE**

**Risk of damage to the device due to the environment**

- Protect the device against electromagnetic interference, ultraviolet rays and, when installed outdoors, the effects of the climatic conditions.



To make sure the device operates correctly, plug in and tighten the female connector.

**Installation onto the pipe**



**ATEX**

Use only brass, stainless steel, aluminium or PVDF sensor-fittings. Any other sensor-fittings are prohibited in explosive areas.

Comply with the safety instructions and the "ATEX instructions notice" (chap. 5) for the type of fluid connection that can be used depending on the place of installation in potentially explosive atmospheres.

When installing the device, respect the instructions given in the Operating Instructions of the sensor-fitting used.

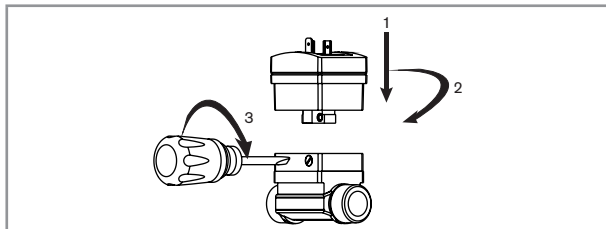

Fig. 1 : Mounting of the SE30 Ex on an S030 sensor-fitting

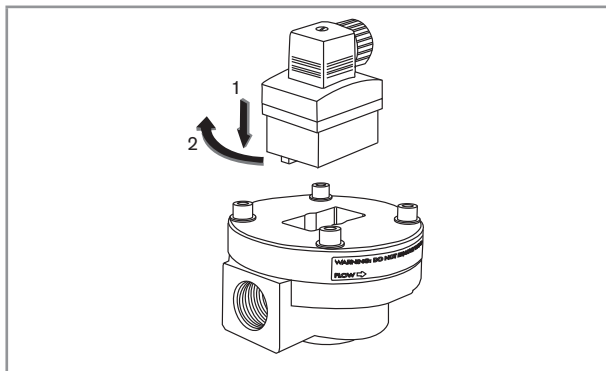

Fig. 2 : Mounting of the SE30 Ex on an S070 or S077 sensor-fitting

**9. WIRING**



**DANGER**

**Risk of injury due to electrical discharge**

- Shut down the electrical power source of all the conductors and isolate it before carrying out work on the system.
- Observe all applicable accident protection and safety regulations for electrical equipment.



**Protect the power supply**

- Protect the power supply with a correctly rated fuse if it is not protected by default.



Use a high quality electrical power supply (filtered and regulated).

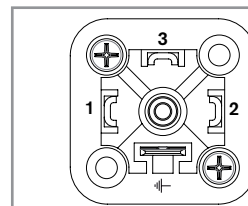

- 1: L+
- 2: not connected
- 3: L-
- ⏚: Functional earth

Fig. 3 : Pin assignment of the male connector

Tab. 1 : Specifications of the cables and conductors for the female connector type 2508 with article number 00167526 (supplied)

Specification of the cables and the conductors (not supplied)	Recommended value
Shielded cable	yes
Length of the cable	max. 50 m
External diameter of the cable	5...8 mm
Maximum operating temperature of the cable	equal to or higher than 80 °C
Cross section of the conductors	0,5...1,5 mm <sup>2</sup>
Line impedance of the conductors	max. 50 Ω

## Assembling the female connector

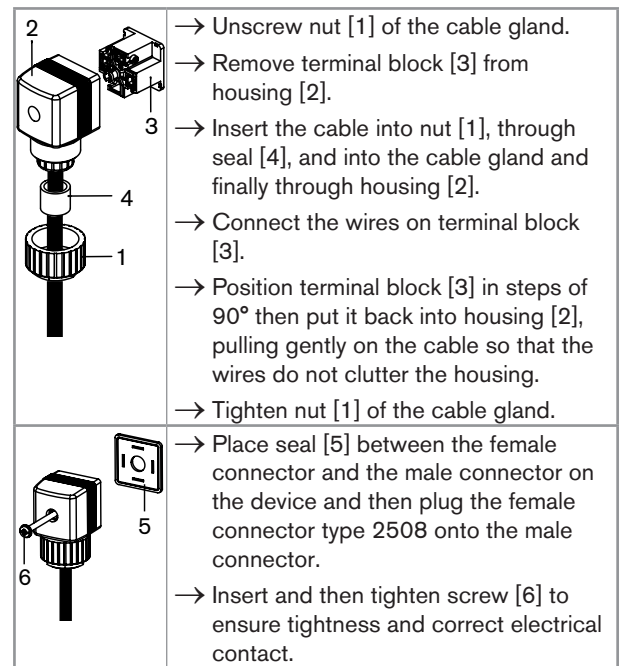

Fig. 4 : Assembling the female connector type 2508 (supplied)

## Wiring of the SE30 Ex, marking II 1 G/D (with NAMUR intrinsic safety barrier)

- Use a shielded cable with an operating temperature suited to the process.
- Use an intrinsic safety barrier with NAMUR input and a power supply, both complying with the safety instructions and with the ATEX instructions notice.

- ⚠ Earth the shielding of the cable on side of the measuring exploitation.
- Before wiring the device, Plug out the female connector.

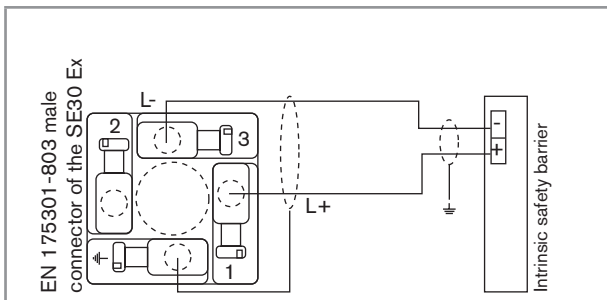

Fig. 5 : Wiring the SE30 Ex to an intrinsic safety barrier

## Connection examples

Connection of the type SE30 Ex to a transmitter type 8025 UNIVERSAL and the externally powered intrinsic safety barrier from Bürkert with article number 00553456 or 00553457.

- ⚠ Refer to the Operating Instructions of the transmitter type 8025 UNIVERSAL for any other wiring instruction.

- To access the intrinsic safety barrier switches, remove the blue mask on the front side.

- Position of the selectors of the transmitter type 8025 UNIVERSAL:
- «SENSOR INPUT LOAD» = «1» (2.2 kΩ)
  - «FLOW SENSOR» = «NPN/PNP»
  - «SENSOR SUPPLY» = any

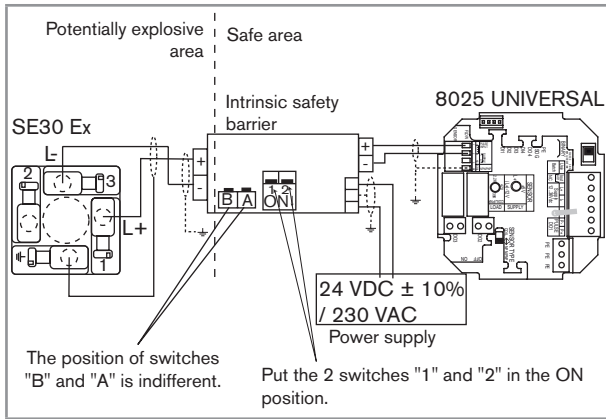

Fig. 6 : Connection between an SE30 Ex and a panel version of the transmitter type 8025 UNIVERSAL

Connection of the type SE30 Ex to a transmitter type 8025 UNIVERSAL and the intrinsic safety barrier, 24 V DC, powered through the transmitter. The safety barrier with article number 00553456 or 00553457 is available from Bürkert.

**!** Refer to the Operating Instructions of the transmitter type 8025 UNIVERSAL for any other wiring instruction.

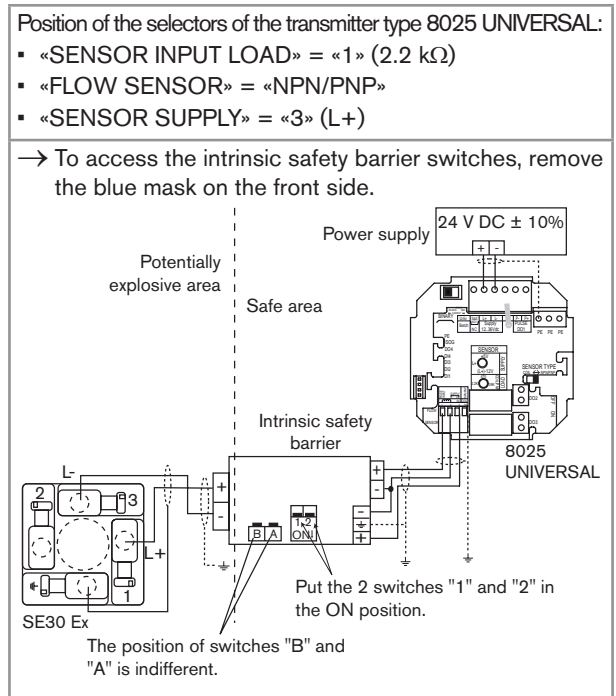

Fig. 7 : Connection between an SE30 Ex and a panel version of the transmitter type 8025 UNIVERSAL

## 10. MAINTENANCE

### Safety instructions

#### **!** DANGER

##### Risk of injury due to electrical voltage.

- Shut down the electrical power source of all the conductors and isolate it before carrying out work on the system.
- Observe all applicable accident protection and safety regulations for electrical equipment.

##### Risk of injury due to high pressure in the installation.

- Stop the circulation of fluid, cut off the pressure and drain the pipe before loosening the process connections.
- Observe the dependency between the fluid temperature and the fluid pressure.

##### Risk of injury due to high fluid temperatures.

- Use safety gloves to handle the device.
- Stop the circulation of fluid and drain the pipe before loosening the process connections.
- Keep all easily flammable material and fluid away from the device.

##### Risk of injury due to the nature of the fluid.

- Respect the prevailing regulations on accident prevention and safety relating to the use of aggressive fluids.

#### **!** WARNING

##### Risk of injury due to non-conforming maintenance.

- Maintenance must only be carried out by qualified and skilled staff with the appropriate tools.
- Ensure that the restart of the installation is controlled after any interventions.

### Cleaning

#### **!** WARNING

##### Potential electrostatic hazard.

- To avoid electrostatic charges, only wipe the housing surface with a damp cloth.

#### NOTE

##### The device may be damaged by the cleaning solution.

- Clean the device with a cloth slightly dampened with water or a cleaning solution compatible with the materials the device is made of.



## 11. ACCESSORIES



### ATTENTION

#### Risk of injury and/or damage caused by the use of unsuitable parts.

Incorrect accessories and unsuitable spare parts may cause injuries and damage the device and the surrounding area.

- Use only original accessories and original spare parts from Bürkert.

Accessories	Article number
EN 175301-803 female connector (type 2508) with blue cable gland and silicone seal	167526
Intrinsic safety barriers, voltage supply 24 V DC, open collector output, 15 V, 60 mA: <ul style="list-style-type: none"><li>▪ 2 channels with dry or Namur contact inputs</li><li>▪ 4 channels with dry or Namur contact inputs</li></ul>	553456 553457

Accessories	Article number
Intrinsic safety barriers, voltage supply 230 V AC, open collector output, 15 V, 60 mA: <ul style="list-style-type: none"><li>▪ 2 channels with dry or Namur contact inputs</li><li>▪ 4 channels with dry or Namur contact inputs</li></ul>	553458 553459

## 12. PACKAGING, TRANSPORT

### ATTENTION

#### Damage due to transport

Transport may damage an insufficiently protected device.

- Transport the device in shock-resistant packaging and away from humidity and dirt.
- Do not expose the device to temperatures that may exceed the admissible storage temperature range.
- Protect the electrical interfaces using protective plugs.

## 13. STORAGE

### ATTENTION

#### Poor storage can damage the device.

- Store the device in a dry place away from dust.
- Storage temperature: 0...+60 °C.

## 14. DISPOSAL

→ Dispose of the device and its packaging in an environmentally-friendly way.

### NOTE

#### Damage to the environment caused by devices contaminated by fluids.

- Keep to the existing provisions on the subject of waste disposal and environmental protection.