

Type 8696 REV.2

Positioner TopControl Basic

Electropneumatic Position Controller
Elektropneumatischer Stellungsregler
Positionneur électropneumatiques



Quickstart

English Deutsch Français

We reserve the right to make technical changes without notice.
Technische Änderungen vorbehalten.
Sous réserve de modifications techniques.

© Bürkert Werke GmbH & Co. KG, 2019

Quickstart 2002/00_EU-ML_00815309 / Original DE

1	ABOUT THESE INSTRUCTIONS	4	8	PNEUMATIC INSTALLATION	14
1.1	Symbols.....	4	9	ELECTRICAL INSTALLATION	15
1.2	Definition of terms	4	9.1	Safety instructions.....	15
2	AUTHORIZED USE	5	9.2	Electrical installation without fieldbus communication.....	15
3	BASIC SAFETY INSTRUCTIONS.....	5	9.3	Electrical installation, IO-Link.....	17
4	GENERAL INFORMATION	6	9.4	Electrical installation, bÜS	17
4.1	Contact address.....	6	10	START-UP.....	18
4.2	Warranty.....	6	10.1	Safety instructions.....	18
4.3	Information on the internet	6	10.2	Automatic adjustment X.TUNE	18
5	SYSTEM DESCRIPTION	7	10.3	Setting with Bürkert Communicator.....	19
5.1	Structure and function.....	7	10.4	IO-Link.....	21
5.2	Model for control of third-party devices.....	8	10.5	bÜS.....	21
6	TECHNICAL DATA.....	9	11	CONTROL AND DISPLAY ELEMENTS.....	22
6.1	Conformity.....	9	11.1	Operating state	23
6.2	Standards.....	9	11.2	Functions of the buttons.....	23
6.3	Licenses	9	11.3	Display of the LEDs	24
6.4	Operating conditions.....	9	12	SAFETY END POSITIONS	27
6.5	Mechanical data	9	13	ACCESSORIES	27
6.6	Type labels.....	10	13.1	Communications software.....	28
6.7	Pneumatic data	10	14	PACKAGING, TRANSPORT, STORAGE	28
6.8	Electrical data.....	11			
6.9	Factory settings.....	12			
7	INSTALLATION	12			
7.1	Safety instructions.....	12			
7.2	Installation of the positioner on process valves of series 2103 and 23xx	13			

1 ABOUT THESE INSTRUCTIONS

The Quickstart contains extremely important information on the device.

→ Keep these instructions ready to hand at the operation site.



Important safety information.

- ▶ Carefully read these instructions.
- ▶ Observe in particular the safety instructions, intended use and operating conditions.
- ▶ Persons, who work on the device, must read and understand these instructions.



The operating instructions can be found on the Internet at:
www.burkert.com

1.1 Symbols



DANGER!

Warns of an immediate danger.

- ▶ Failure to observe the warning may result in a fatal or serious injury.



WARNING!

Warns of a potentially dangerous situation.

- ▶ Failure to observe the warning may result in serious or fatal injuries.



CAUTION!

Warns of a possible danger.

- ▶ Failure to observe the warning may result in moderate or minor injuries.

ATTENTION!

Warns of damage to property.

- ▶ Failure to observe the warning may result in damage to the device or system.



Indicates important additional information, tips and recommendations.



Refers to information in these instructions or in other documentation.

- ▶ Designates an instruction to prevent risks.
- Designates a procedure that must be carried out.
- ✓ Indicates a result.

1.2 Definition of terms

In these instructions the term “device” denotes the following device types: positioner Type 8696 REV.2.

The term “büs” (Bürkert system bus) used in this instruction stands for the communication bus developed by Bürkert and based on the CANopen protocol.

In these instructions, the abbreviation “Ex” always refers to “potentially explosive area”.

2 AUTHORIZED USE

The Positoner Type 8696 REV.2 is designed to be mounted on pneumatic actuators of process valves for the control of media. The permitted fluid media are listed in the technical data.

- ▶ Use the device for its intended purpose only. Non-intended use of the device may be dangerous to people, nearby equipment and the environment.
- ▶ Correct transportation, correct storage as well as correct installation, commissioning, operation and maintenance are essential for reliable and problem-free operation.
- ▶ When using the device, observe the permitted data, operating conditions and application conditions. This information can be found in the contractual documents, the operating instructions and on the type label.
- ▶ Use the device only in conjunction with third-party devices and components recommended and authorized by Bürkert.
- ▶ Do not use the device outdoors without protection from the weather.
- ▶ In areas at risk of explosion, only use devices approved for use in those areas. These devices are labeled with a separate Ex type label. For such use, note the information provided on the separate Ex type label and the additional explosion-related information or separate explosion-related operating instructions.

3 BASIC SAFETY INSTRUCTIONS

These safety instructions do not consider any contingencies or incidents which occur during installation, operation and maintenance. The operator is responsible for observing the location-specific safety regulations, also with reference to the personnel.



DANGER

Risk of injury from high pressure and discharge of medium.

- ▶ Before working on the device or system, switch off the pressure. Vent or drain lines.

Risk of injury from electric shock.

- ▶ Before working on the device or system, switch off the power supply. Secure against reactivation.
- ▶ Observe applicable accident prevention and safety regulations for electrical equipment.

To prevent injury, ensure the following:

- ▶ Secure device or system to prevent unintentional activation.
- ▶ Only trained technicians may perform installation and maintenance work.
- ▶ Perform installation and maintenance with suitable tools only.
- ▶ Do not make any changes to the device and do not subject it to mechanical stress.
- ▶ Operate the device only in perfect state and in consideration of the operating instructions.
- ▶ Observe the general rules of technology.
- ▶ Install the device according to the regulations applicable in the respective country.

- ▶ When unscrewing and screwing in the body casing or the transparent cap, do not hold the actuator of the process valve but the basic housing of Type 8696.
- ▶ Do not feed corrosive or flammable media into the device connections.
- ▶ Do not feed any fluids into the connections of the device.
- ▶ After the process is interrupted, restart in a controlled manner. Observe sequence:
 1. Connect electrical or pneumatic power supply.
 2. Charge the device with medium.
- ▶ Observe intended use.

ATTENTION!

Electrostatic sensitive components or modules.

The device contains electronic components which react sensitively to electrostatic discharge (ESD). Contact with electrostatically charged persons or objects is hazardous to these components. In the worst case scenario, they will be destroyed immediately or will fail after start-up.

- ▶ Observe the requirements in accordance with EN 61340-5-1 to minimize or avoid the possibility of damage caused by sudden electrostatic discharge.
- ▶ Also ensure that you do not touch electronic components when the power supply voltage is present.

4 GENERAL INFORMATION

4.1 Contact address

Germany

Bürkert Fluid Control System
Sales Center
Chr.-Bürkert-Str. 13-17
D-74653 Ingelfingen
Tel. + 49 (0) 7940 - 10 91 111
Fax + 49 (0) 7940 - 10 91 448
E-mail: info@burkert.com

International

Contact addresses can be found on the final pages of the printed operating instructions.

And also on the Internet at:

www.burkert.com

4.2 Warranty

The warranty is only valid if the positioner Type 8696 is used as intended in accordance with the specified application conditions.

4.3 Information on the internet

The operating instructions and data sheets for Type 8696 can be found on the Internet at:

www.burkert.com

5 SYSTEM DESCRIPTION

5.1 Structure and function

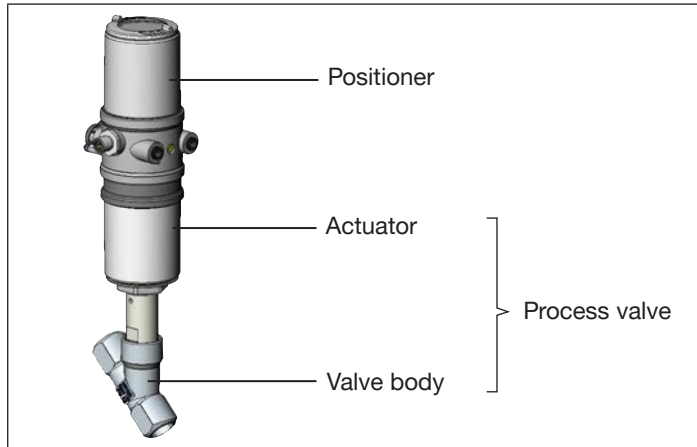

Fig. 1: Structure 1

Positioner Type 8696 is an electropneumatic position controller for pneumatically actuated control valves with single-acting actuators. Together with the pneumatic actuator, the positioner forms a functional unit.

The control valve systems can be used for a wide range of control tasks in fluid technology and, depending on the application conditions, different process valves from the Bürkert range can be combined with the positioner. Angle seat valves, straight seat valves or diaphragm valves of the Type 2300, 2301 or 2103 with an actuator size of 50 mm are suitable.

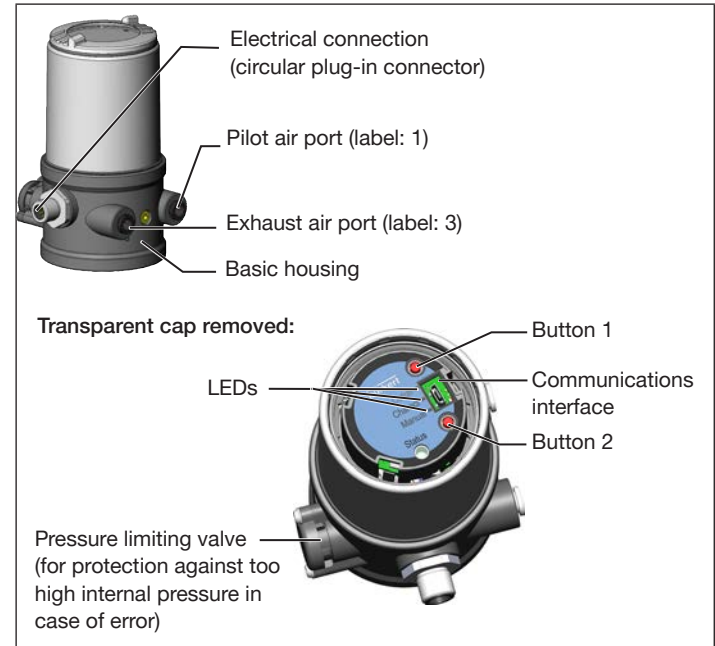

Fig. 2: Structure 2

The position of the actuator is regulated according to the position set-point value. The nominal position value is specified by an external standard signal.

5.2 Model for control of third-party devices

A special model enables the positioner Type 8696 to be attached to third-party devices.

This model has a different basic housing so that the pilot air ports can be connected to the outside of the actuator.

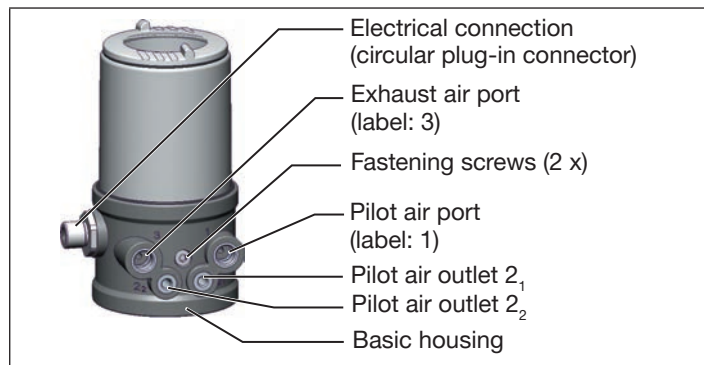

Fig. 3: Model for third-party devices

ATTENTION!

Damage or malfunction due to ingress of dirt and moisture.

- ▶ To comply with protection class IP65 / IP67, connect the pilot air outlet (only for CFA or CFB) which is not required to the free pilot air port of the third-party device or seal with a plug.



“In rest position” means that the pilot valves of the positioner Type 8696 are isolated or not actuated.



If the ambient air is humid, a hose can be connected between pilot air outlet 2₂ of the positioner and the unconnected pilot air port of the third-party device for control function A or control function B. As a result, the spring chamber of the third-party device is supplied with dry air from the vent duct of the positioner.

Control function (CF)		Pneumatic connection Type 8696 with third-party device	
A	Process valve closed in rest position (by spring force)	Pilot air outlet	
	Process valve open in rest position (by spring force)	Pilot air outlet	

Tab. 1: Pneumatic connection to third-party device

1) Connection optionally, see note.

6 TECHNICAL DATA

6.1 Conformity

In accordance with the EU Declaration of conformity, the positioner Type 8696 is compliant with the EU Directives.

6.2 Standards

The applied standards, which verify conformity with the EU Directives, can be found on the EU-Type Examination Certificate and / or the EU Declaration of Conformity.

6.3 Licenses

The product is approved for use in zone 2 and 22 in accordance with ATEX directive 2014/34/EU category 3GD.



Observe instructions on operation in an explosion-risk (Ex) area. Observe the ATEX additional instructions.

The product is cULus approved. Instructions for use in the UL area see chapter [“6.8 Electrical data”](#).

6.4 Operating conditions



WARNING!

Solar radiation and temperature fluctuations may cause malfunctions or leaks.

- ▶ If the device is used outdoors, do not expose it unprotected to the weather conditions.
- ▶ Ensure that the permitted ambient temperature does not exceed the maximum value or drop below the minimum value.

Ambient temperature

see type label

Degree of protection

Evaluated by the manufacturer:	Evaluated by UL:
IP65 / IP67 according to EN 60529 ²⁾	UL Type 4x Rating ²⁾

Operating altitude:

up to 2000 m above sea level

2) *Only if cables, plugs and sockets have been connected correctly and in compliance with the exhaust air concept, see chapter [“8 Pneumatic installation”](#).*

6.5 Mechanical data

Dimensions

See data sheet

Body material

exterior: PPS, PC, stainless steel
interior: PA6, ABS

Sealing material

EPDM / FKM

Stroke range
of valve spindle

Series 2103
and 23xx 3 – 32 mm

Third-party devices
(modified guide
element required) 3 – 40 mm

6.6 Type labels

6.6.1 Type label (example)

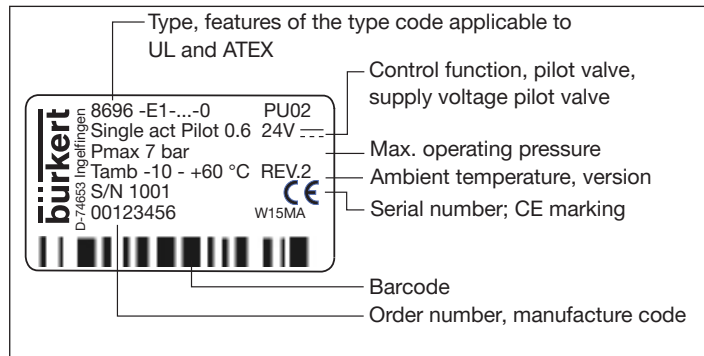

Fig. 4: Type label (example)

6.6.2 UL additional label (example)

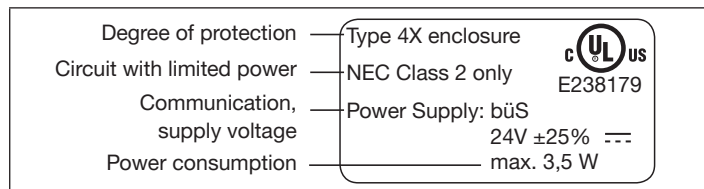

Fig. 5: UL additional label (example)

6.7 Pneumatic data

Control medium	neutral gases, air	
	Quality classes in accordance with ISO 8573-1	
Dust content	Class 7	max. particle size 40 µm, max. particle density 10 mg/m ³
Water content	Class 3	max. pressure dew point -20 °C or min. 10 °C below the lowest operating temperature
Oil content	Class X	max. 25 mg/m ³
Temperature range		-10 – +50 °C
Pressure range		3 – 7 bar
Air output of pilot valve:		7 l _N /min (for aeration and deaeration) (Q _{Nn} value according to definition for pressure drop from 7 to 6 bar absolute)
Connections:		
	23xx / 2103 (Element)	Plug-in hose connector Ø 6mm / 1/4" Socket connection G1/8
Model third-party device		Socket connection G1/8 with M5 connection for connecting to the third-party device

6.8 Electrical data



WARNING!

Only circuits with limited power may be used for UL approved components according to "NEC Class 2".

6.8.1 Electrical data, without fieldbus communication

Protection class	III as per DIN EN 61140 (VDE 0140-1)
Connections	Circular plug-in connector (M12 x 1, 8-pin)
Operating voltage	24 V DC \pm 25%, max. residual ripple 10 %
Current consumption	max. 150 mA
Power consumption	max. 3.5 W
Input resistance for set-point value signal	75 Ω at 0/4 – 20 mA / 12 bit resolution
Analogue position feedback max. load for current output 0/4 – 20 mA	560 Ω
Digital input	0 – 5 V = log "0", 12 – 30 V = log "1" inverted input in reverse order
Communications interface	Connection to PC via USB-büS interface set
Communication software	Bürkert Communicator

6.8.2 Electrical data, IO-Link

Protection class	III as per DIN EN 61140 (VDE 0140-1)
Connection	Circular plug-in connector M12 x 1, 5-pin, A-coded, Port Class B
Operating voltage	
System supply (Pin 1+3)	24 V DC \pm 25 % (according to specification)
Actuator supply (Pin 2+5) ¹⁾	24 V DC \pm 25 % (according to specification)
Current consumption	
System supply (Pin 1+3)	max. 50 mA
Actuator supply (Pin 2+5)	max. 100 mA
Total power consumption	max. 3.5 W

3) *Actuator supply is galvanically isolated from system supply in accordance with IEC 60664 and for electrical safety in accordance with SELV from IEC 61010-2-201*

6.8.3 Electrical data, büS

Protection class	III as per DIN EN 61140 (VDE 0140-1)
Connection	Circular plug-in connector M12 x 1, 5-pin, A-coded
Operating voltage	24 V DC \pm 25 %
Current consumption	max. 150 mA
Total power consumption	max. 3.5 W

6.9 Factory settings

Function	Parameter	Value
<i>CUTOFF</i>	Sealing function below Sealing function above	2 % 98 %
<i>CHARACT</i>	Characteristic correction	FREE ³⁾
<i>DIR.CMD</i>	Reversal of the effective direction set-point value	Off

Tab. 2: *Factory settings*



Additional functions are described in the operating instructions Type 8696 REV.2.

These instructions can be found on the Internet at www.burkert.com.

4) Without change to the settings via the communications software a linear characteristic is stored in FREE.

7 INSTALLATION



Only for positioner without pre-assembled process valve.

7.1 Safety instructions



DANGER!

Risk of injury from high pressure in the equipment/device.

- ▶ Before working on equipment or device, switch off the pressure and deaerate/drain lines.

Risk of electric shock.

- ▶ Before working on equipment or device, switch off the power supply and secure to prevent reactivation.
- ▶ Observe applicable accident prevention and safety regulations for electrical equipment.



WARNING!

Risk of injury from improper installation.

- ▶ Installation may be carried out by authorized technicians only and with the appropriate tools.

Risk of injury from unintentional activation of the system and an uncontrolled restart.

- ▶ Secure system from unintentional activation.
- ▶ Following assembly, ensure a controlled restart.

7.2 Installation of the positioner on process valves of series 2103 and 23xx

ATTENTION!

When mounting on process valves with a welded connection, follow the installation instructions in the operating instructions for the process valve.

 When the positioner is being installed, the collets of the pilot air ports must not be fitted to the actuator.

ATTENTION!

Damaged printed circuit board or malfunction.

▶ Ensure that the puck is situated flat on the guide rail.

- Align the puck and the positioner until
1. the puck can be inserted into the guide rail of the positioner (see “Fig. 6”) and
 2. the connection pieces of the positioner can be inserted into the pilot air ports of the actuator (see also “Fig. 7”).

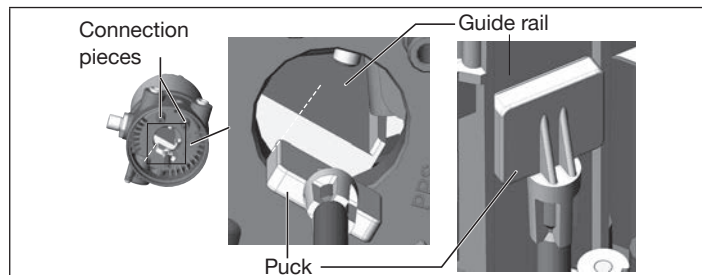

Fig. 6: Aligning the puck

- Push the positioner, without turning it, onto the actuator until no gap is visible on the form seal.

ATTENTION!

Too high torque when screwing in the fastening screw does not ensure protection class IP65 / IP67.

▶ The fastening screws may be tightened to a maximum torque of 1.5 Nm only.

- Attach the positioner to the actuator using the two side fastening screws. In doing so, tighten the screws only hand-tight (max. torque: 1.5 Nm).

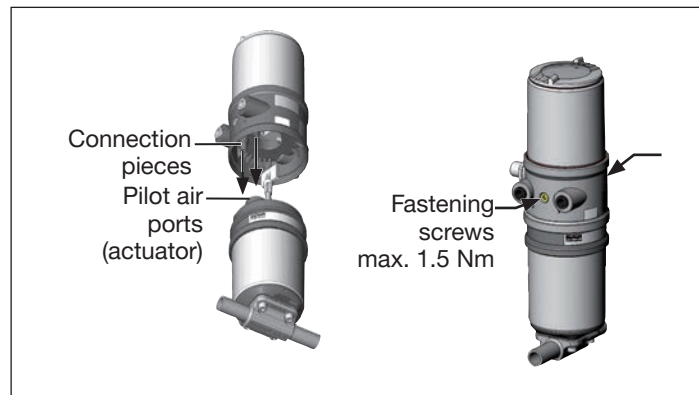

Fig. 7: Installation of positioner, 2103 and 23xx series

8 PNEUMATIC INSTALLATION



DANGER!

Risk of injury from high pressure in the equipment/device.

- ▶ Before working on equipment or device, switch off the pressure and deaerate/drain lines.

Procedure:

- Connect the control medium to the pilot air port (1) (3 – 7 bar; instrument air, free of oil, water and dust).
- Attach the exhaust airline or a silencer to the exhaust air port (3) (see “[Fig. 8: Pneumatic connection](#)”).

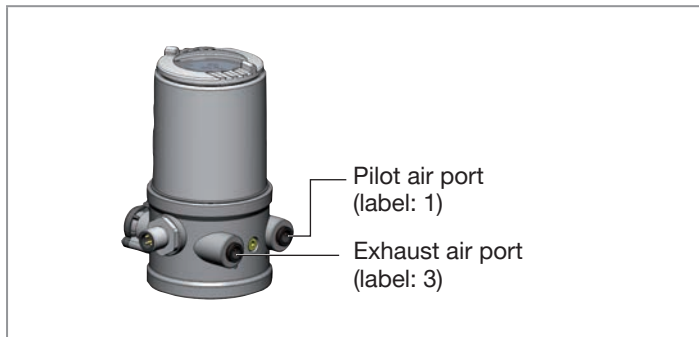

Fig. 8: Pneumatic connection



Caution: (Exhaust air concept):

In compliance with protection class IP67, an exhaust air line must be installed in the dry area.



Important information for the problem-free functioning of the device:

- ▶ The installation must not cause back pressure to build up.
- ▶ Select a hose for the connection with an adequate cross-section.
- ▶ The exhaust air line must be designed in such a way that no water or other liquid can get into the device through the exhaust air port.
- ▶ Keep the adjacent supply pressure **always** at least 0.5 – 1 bar above the pressure which is required to move the actuator to its end position. This ensures that the control behavior is not extremely negatively affected in the upper stroke range on account of too little pressure difference.
- ▶ During operation keep the fluctuations of the pressure supply as low as possible (max. $\pm 10\%$). If fluctuations are greater, the control parameters measured with the *X.TUNE* function are not optimum.

9 ELECTRICAL INSTALLATION

All electrical inputs and outputs of the device are not galvanically isolated from the supply voltage.

9.1 Safety instructions



DANGER!

Risk of electric shock.

- ▶ Before working on equipment or device, switch off the power supply and secure to prevent reactivation.
- ▶ Observe applicable accident prevention and safety regulations for electrical equipment.



WARNING!

Risk of injury from improper installation.

- ▶ Installation may be carried out by authorized technicians only and with the appropriate tools.

Risk of injury from unintentional activation of the system and an uncontrolled restart.

- ▶ Secure system from unintentional activation.
- ▶ Following installation, ensure a controlled restart.

9.2 Electrical installation without fieldbus communication

→ Connect the positioner according to the table.

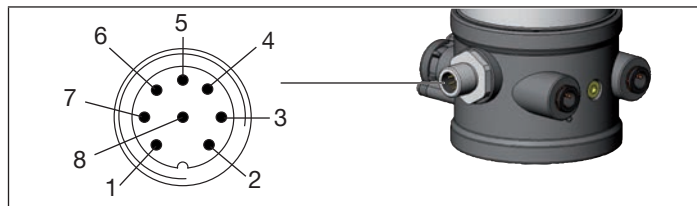

Fig. 9: Circular plug M12 x 1, 8-pin

Input signals of the control center (e.g. PLC)

Pin	Wire color ⁵⁾	Configuration	External circuit, signal level
1	white	Set-point value + (0/4 – 20 mA)	1 — + (0/4 – 20 mA)
2	brown	Set-point value GND	2 — GND see table connection type 3-wire or 4-wire
5	grey	Digital input +	5 — + $\begin{cases} 0 - 5 \text{ V (log. 0)} \\ 10 - 30 \text{ V (log. 1)} \end{cases}$
6	pink	Digital input GND	6 — GND

Tab. 3: Pin assignment, input signals of the control center

5) The indicated colors refer to the connecting cable available as an accessory (919061).

Operating voltage

Pin	Wire color ⁶⁾	Configuration	External circuit
3	green	GND	
4	yellow	+ 24 V	

Tab. 4: Pin assignment, operating voltage

Output signals to the control center, (for analogue output variant only)

Pin	Wire color ⁶⁾	Configuration	External circuit, signal level
8	red	Analogue position feedback +	8 — + (0/4 – 20 mA)
7	blue	Analogue position feedback GND	7 — GND

Tab. 5: Pin assignment, output signals of the control center, variant

6) The indicated colors refer to the connecting cable available as an accessory (919061).

Connection type 3-wire or 4-wire

Setting via communication software

Connection type 4-wire (factory setting)

The set-point value input is designed as a differential input, i.e. the GND lines of the set-point value input and the supply voltage are not identical.

Note: If the GND signals of the set-point value input and the supply voltage are connected, the 3-wire connection type must be set in the software.

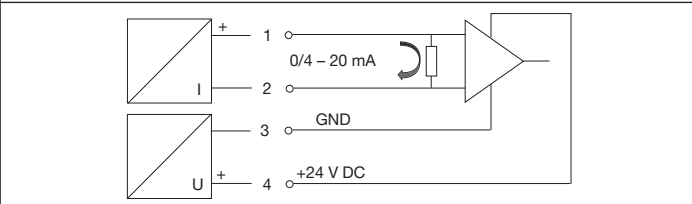

Connection type 3-wire

The set-point value input is related to the GND line of the supply voltage, i.e. setpoint input and supply voltage have a common GND line.

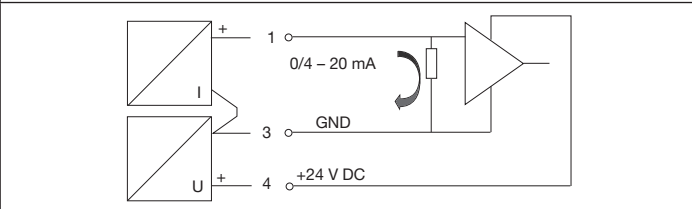

Tab. 6: Connection type 3-wire or 4-wire

9.3 Electrical installation, IO-Link

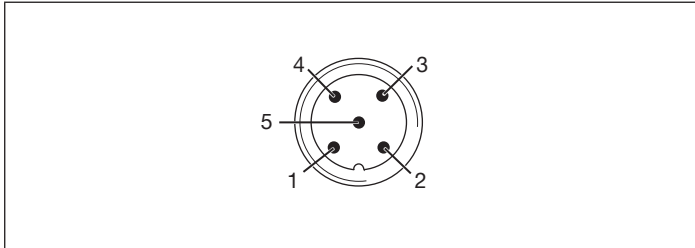

Fig. 10: Pin assignment, Port Class B

Pin	Designation	Configuration	
1	L +	24 V DC	System supply
2	P24	24 V DC	Actuator supply
3	L -	0 V (GND)	System supply
4	C/Q	IO-Link	
5	M24	0 V (GND)	Actuator supply

Tab. 7: Pin assignment

9.4 Electrical installation, bÜS

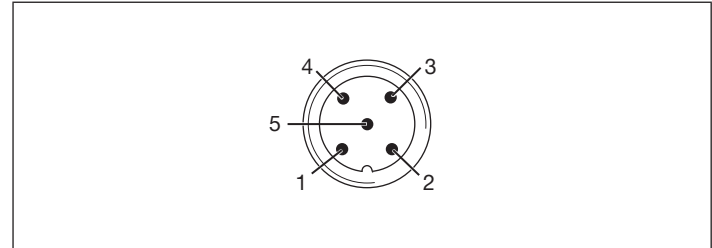

Fig. 11: Pin assignment

Pin	Wire color	Configuration
1	CAN plate/shielding	CAN plate/shielding
2	red	+24 V DC ± 25 %, max. residual ripple 10 %
3	black	GND / CAN_GND
4	white	CAN_H
5	blue	CAN_L

Tab. 8: Pin assignment



For electrical installation with bÜS network, note:
Use a 5-pin round plug and shielded 5-core cable.
The shielding in the device is not connected to the functional earth.

10 START-UP

10.1 Safety instructions



WARNING!

Risk of injury from improper operation.

Improper operation may result in injuries as well as damage to the device and the area around it.

- ▶ Before start-up, ensure that the operating personnel are familiar with and completely understand the contents of the operating instructions.
- ▶ Observe the safety instructions and intended use.
- ▶ Only adequately trained personnel may operate the equipment/the device.

10.2 Automatic adjustment *X.TUNE*



To adjust the positioner to local conditions, the *X.TUNE* function must be run following installation.



WARNING!

Danger due to the valve position changing when the *X.TUNE* function is running.

When the *X.TUNE* is running under operating pressure, there is an acute risk of injury.

- ▶ Never run *X.TUNE* while a process is running.
- ▶ Take appropriate measures to prevent the equipment from being accidentally actuated.

ATTENTION!

Avoid maladjustment of the controller due to an incorrect pilot pressure or applied operating medium pressure.

- ▶ Run *X.TUNE* **whenever** the pilot pressure (= pneumatic auxiliary energy) is available during subsequent operation.
- Run the *X.TUNE* function preferably without operating medium pressure to exclude interference caused by flow forces.

ATTENTION!

Breakage of the pneumatic connection pieces due to rotational impact.

- ▶ When unscrewing and screwing in the transparent cap, do not hold the actuator of the process valve but the basic housing.

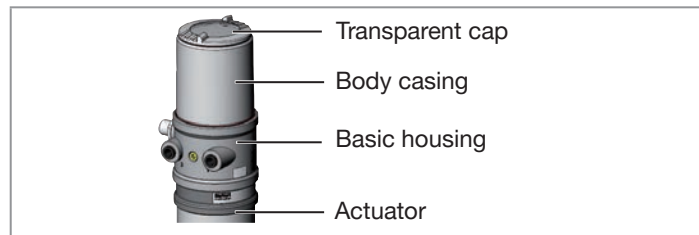

Fig. 12: Open positioner



To run *X.TUNE*, the positioner must be in the AUTOMATIC operating status (manual LED is not lit).

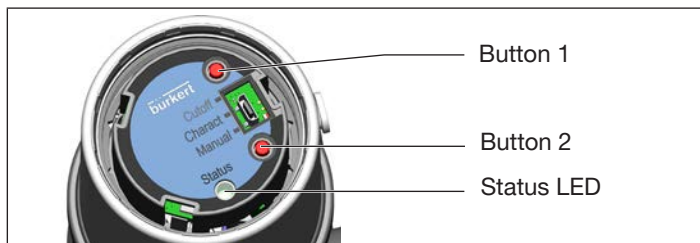

Fig. 13: Starting X.TUNE

- Screw off the transparent cap of the positioner to operate the buttons.
- Start the X.TUNE by pressing button 1⁷⁾ for 5 s.

The device is in the NAMUR state function check, status LED lights orange.

If the X.TUNE is successfully completed, the NAMUR state is reset again. The changes are automatically transferred to the memory (EEPROM) provided the X.TUNE function is successful.

When status LED lights red after X.TUNE:

- Execute X.TUNE again.
- Perform a device restart if necessary.

The changes are automatically transferred to the memory (EEPROM) provided the X.TUNE function is successful.

7) The X.TUNE can also be started via communications software.

ATTENTION!

Breakage of the pneumatic connection pieces due to rotational impact.

- ▶ When unscrewing and screwing in the transparent cap, do not hold the actuator of the process valve but the basic housing.

Damage or malfunction due to penetration of dirt and humidity.

- ▶ To observe degree of protection IP65 / IP67, screw the transparent cap in all the way.

- Close the device (assembly tool: 674078⁸⁾).

10.3 Setting with Bürkert Communicator

The Bürkert Communicator can be used to make all settings on the device.



The settings in the Bürkert Communicator can be found in the operating manual.

8) The assembly tool (674078) is available from your Bürkert sales office.

10.3.1 Connecting IO-Link device with Bürkert Communicator

Required components:

- Communications software: Bürkert Communicator for PC
- USB-büS interface set (see accessories)
- büS adapter for communication interface (see accessories)
- If necessary, a büS cable extension (see accessories)

ATTENTION

Breakage of the pneumatic connection pieces due to rotational impact.

- ▶ When opening or closing the device, do not press against the actuator, but against the basic housing.

→ Screw off the transparent cap by turning counterclockwise.

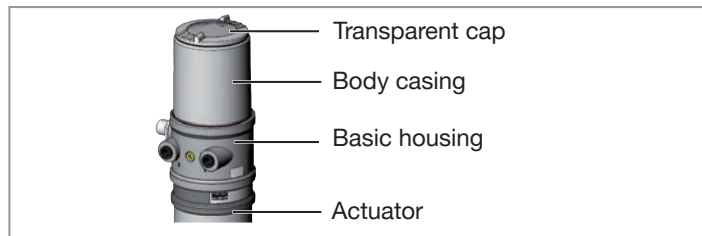

Fig. 14: Open positioner

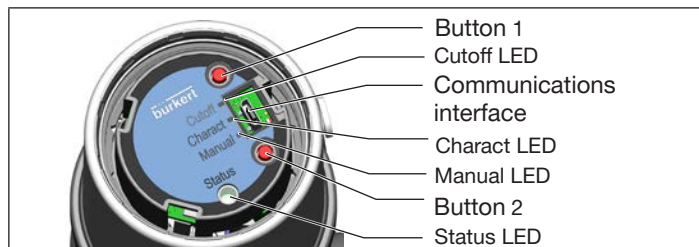

Fig. 15: Communications interface

- Insert micro USB plug in communication interface.
- Establish connection to PC with USB-büS interface set.
- Starting Bürkert Communicator.
- Implementing settings.

10.3.2 Connecting büS device with Bürkert Communicator

Required components:

- Communications software: Bürkert Communicator for PC
- büS standard set (see accessories)

- Establish connection to PC with USB-büS interface set.
- Starting Bürkert Communicator.
- Implementing settings.

10.4 IO-Link

10.4.1 Information, IO-Link

IO-Link is an internationally standardized IO technology (IEC 61131-9) to enable sensors and actuators to communicate.

IO-Link is a point-to-point communication with 3-wire connection technology for sensors and actuators and unshielded standard sensor cables.

To ensure clear communication, the IO-Link devices should not be parameterised simultaneously by the higher-level controller (PLC) via the IO-Link master and with the Bürkert Communicator (via the service

10.4.2 interface). Technical specifications, IO-Link

IO-Link specifications	V1.1.2
Supply	via IO-Link (M12 x 1, 5-pin, A-coded)
Port Class	B
SIO mode	no
IODD file	see Internet
VendorID	0x0078, 120
DeviceID	see IODD file
ProductID	8696
Transmission speed	COM3 (230.4 kbit/s)
PD Input Bits	80
PD Output Bits	40
M-sequence Cap.	0x0D
Min. cycle time	1 ms

Data storage	Yes
Max. cable length	20 m

10.4.3 Configuration of the fieldbus

The required start-up files and the description of the process data and acyclic parameters are available on the Internet.



Download from:
www.burkert.com / Type 8696 / Software

10.5 bÜS

10.5.1 Information, bÜS

bÜS is a system bus developed by Bürkert with a communication protocol based on CANopen.

10.5.2 Configuration of the fieldbus

The required start-up files and the description of objects are available on the Internet.



Download from:
www.burkert.com / Type 8696 / Software

11 CONTROL AND DISPLAY ELEMENTS



A detailed description of the operation and functions of the positioner and the communication software can be found in the respective operating instructions.

ATTENTION!

Breakage of the pneumatic connection pieces due to rotational impact.

- ▶ When unscrewing and screwing in the transparent cap, do not hold the actuator of the process valve but the basic housing.

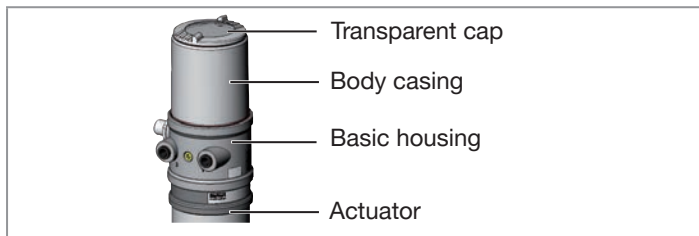

Fig. 16: Open positioner

- Screw off the transparent cap of the positioner to operate the buttons.

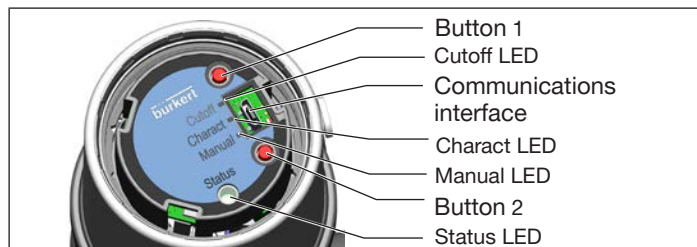

Fig. 17: Description of the control elements

ATTENTION!

Breakage of the pneumatic connection pieces due to rotational impact.

- ▶ When unscrewing and screwing in the transparent cap, do not hold the actuator of the process valve but the basic housing.

Damage or malfunction due to penetration of dirt and humidity.

- ▶ To observe degree of protection IP65 / IP67, screw the transparent cap in all the way.

- Close the device (assembly tool: 674078⁹⁾).

9) The assembly tool (674078) is available from your Bürkert sales office.

11.1 Operating state



To operate the buttons, make sure that the local control lock is deactivated/unlocked (factory setting): with communication software or fieldbus communication.

AUTOMATIC (AUTO)

Normal controller mode is implemented and monitored in AUTOMATIC operating state.

MANUAL (MANU)

In MANUAL operating state the valve can be opened and closed manually via the buttons.

The manual LED is lit red.

The buttons can be used to switch between the two operating states AUTOMATIC and MANUAL:

→ Press both buttons simultaneously between 2 s and 10 s (manual LED flashes at 5 Hz).

11.2 Functions of the buttons



To operate the buttons, make sure that the local control lock is deactivated/unlocked (factory setting): with communication software or fieldbus communication.

The configuration of the 2 buttons on the board varies depending on the operating state (AUTOMATIC / MANUAL).

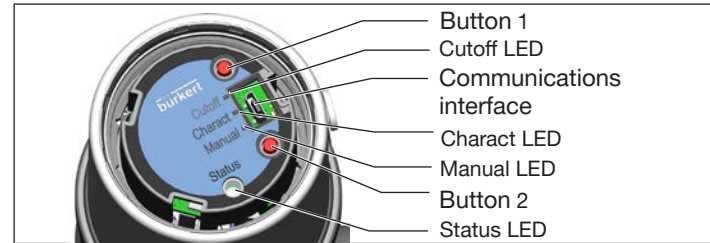

Fig. 18: Buttons

MANUAL operating state (manual LED is lit red):

Button	Function/LED
1	Press and hold Aerate (manually open / close the actuator) ¹⁰⁾
2	Press and hold Deaerate (manually open / close the actuator) ¹⁰⁾
1 and 2 simultaneously	Press longer than 2 s (< 10 s, manual LED flashes at 5 Hz, 0 – 2 s): Switching to AUTOMATIC operating state
	Press longer than 10 s (< 30 s, manual LED, charact LED and cutoff LED flash at 5 Hz, 10 – 30 s): Device restart
	Press longer than 30 s (manual LED, charact LED and cutoff LED flash at 10 Hz, > 30 s): Reset device to factory setting

Tab. 9: Configuration of the buttons for MANUAL operating state

¹⁰⁾depending on the operating principle of the actuator.

AUTOMATIC operating state (manual LED is not lit):

Button	Function/LED
1	Press longer than 2 s: (< 5 s, cutoff LED flashes at 5 Hz (0 – 2 s) and at 10 Hz (2 – 5 s): Activates/deactivates CUTOFF function CUTOFF function activated: Cutoff LED is lit yellow
	Press longer than 5 s (< 10 s, status LED is lit orange): Starting the X.TUNE function
2	Press longer than 2 s (cutoff LED flashes at 5 Hz (0 – 2 s) and at 10 Hz (2 – 5 s): Activates/deactivates CHARACT function CHARACT function activated: charact LED is light green
1 and 2 simultaneously	Press longer than 2 s (< 10 s, manual LED flashes at 5 Hz, 0 – 2 s): Switching to MANUAL operating state
	Press longer than 10 s (< 30 s, manual LED and charact LED flash at 5 Hz, 10 – 30 s): Device restart
	Press longer than 30 s (manual LED, charact LED and cutoff LED flash at 10 Hz, > 30 s): Reset device to factory setting

Tab. 10: Configuration of the buttons for AUTOMATIC operating state

11.3 Display of the LEDs

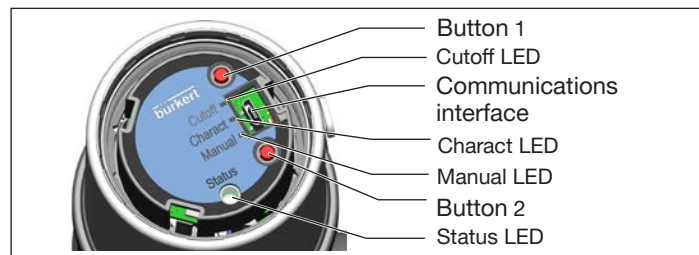

Fig. 19: Display of the LEDs

Status LED (RGB)	Display of the device status and valve position
Cutoff LED (yellow)	CUTOFF active/inactive
Manual LED (red)	Operating state HAND active/inactive
Charact LED (green)	CHARACT active/inactive

Cutoff LED

Color	Status	Description
yellow	is lit	CUTOFF active
yellow	is not lit	CUTOFF inactive

Tab. 11: Cutoff LED

Manual LED

Color	Status	Description
red	is lit	Operating state HAND active
red	is not lit	Operating state AUTOMATIC active

Tab. 12: Manual LED

Charact LED

Color	Status	Description
green	is lit	CHARACT active
green	is not lit	CHARACT inactive

Tab. 13: Charact LED

11.3.1 Status indicator

The status LED (RGB) show the device status.

The user can set the following LED modes for the display of device status and valve position.

- Valve mode
- Valve mode with warnings (factory setting)
- NAMUR mode
- Fixed color
- LED off

The LED mode and the colors of the valve position can be set with the Bürkert Communicator.

IO-Link:

The LED mode and the colors of the valve position can be also set with an acyclic parameter (see parameter list).



The description for setting the LED mode can be found in the section "Setting the LED mode, status indicator" in the operating instruction.

Valve mode + warnings

Displays in valve mode + warnings:

- Valve position: open, half-way, closed
- Device status: failure, function check, out of specification, maintenance required (according to NAMUR)

Valve position	Device status	
	Status, color	Normal operation
Open	is lit yellow*	--
Half-way	LED off*	--
Closed	is lit green*	--

Tab. 14: Valve mode + warnings, normal operation

* Factory setting, selectable colors for the valve position: Off, white, green, blue, yellow, orange, red

If several device statuses exist simultaneously, the device status with the highest priority is displayed.

Valve position	Device status				
	Failure	Function check	Out of specification	Maintenance required	
	Status, color	Status, color	Status, color	Status, color	
Open	flashes red	flashes orange	flashes yellow	blinks blue	alternately with yellow*
Half-way	flashes red	flashes orange	flashes yellow	blinks blue	alternately with LED off*
Closed	flashes red	flashes orange	flashes yellow	flashes blue	alternately with green*

Tab. 15: Valve mode + warnings, device status

For warning messages, the LEDs are briefly switched off between the change of the colors.

For localizations, the colors are only shown momentarily.

11.3.2 NAMUR mode

The device status LED show the device status.

The display elements change color in accordance with NAMUR NE 107.

* Factory setting, selectable colors for the valve position: Off, white, green, blue, yellow, orange, red

If several device statuses exist simultaneously, the device status with the highest priority is displayed. The priority is determined by the severity of the deviation from controlled operation (red LED = failure = highest priority).

Status display in accordance with NE 107, edition 2006-06-12			
Color	Color code	Status	Description
Red	5	Outage, error or malfunction	Normal operation is not possible due to a malfunction in the device or on its peripheral equipment.
Orange	4	Function check	Work is being carried out on the device; normal operation is therefore temporarily not possible
Yellow	3	Out of specification	Ambient conditions or process conditions for the device are outside the specified area.
Blue	2	Maintenance required	The device is in normal operation, although a function is briefly restricted. → Service device.
Green	1	Diagnostics active	Device is operating perfectly. Status changes are indicated in different colors. Messages are transmitted via a fieldbus if connected.

Tab. 16: Description of the colors

12 SAFETY END POSITIONS

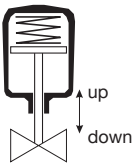
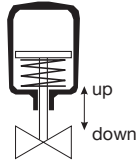
Actuator system	Designation	Safety end positions after failure of the auxiliary power	
		electrical	pneumatic
	single-acting Control function A	down	not defined
	single-acting Control function B	up	not defined

Tab. 17: Safety end positions

13 ACCESSORIES

Designation	Order no.
Communication software Bürkert Communicator	Information at www.burkert.com
Connection cable M12 x 1, 8-pin	919061
Wrench for opening/closing the transparent cap	647078

USB-büS interface set:	
USB-büS interface set (büS stick + 0.7 m cable with M12 plug)	772551
büS adapter for communication interface (M12 on büS service interface Micro-USB)	773254
büS cable extension (M12 pin to M12 socket), length 1 m	772404
büS cable extension (M12 pin to M12 socket), length 3 m	772405
büS cable extension (M12 pin to M12 socket), length 5 m	772406
büS cable extension (M12 pin to M12 socket), length 10 m	772407

Tab. 18: Accessories

13.1 Communications software

The PC operating program Bürkert Communicator is designed for communication with the devices from the Bürkert positioner family. If you have any questions regarding compatibility, please contact the Bürkert Sales Center.



A detailed description and precise schedule of the procedure for the installation and operation of the software can be found in the associated documentation.

Download the software at: www.burkert.com

14 PACKAGING, TRANSPORT, STORAGE

ATTENTION!

Transport damages.

Inadequately protected equipment may be damaged during transport.

- ▶ During transportation protect the device against wet and dirt in shock-resistant packaging.
- ▶ Avoid exceeding or dropping below the permitted storage temperature.

Incorrect storage may damage the device.

- ▶ Store the device in a dry and dust-free location.
- ▶ Storage temperature -20 – +65 °C.

Damage to the environment caused by device components contaminated with media.

- ▶ Dispose of the device and packaging in an environmentally friendly manner.
- ▶ Observe applicable regulations on disposal and the environment.

www.burkert.com