

Type 8696

Positioner TopControl Basic

Electropneumatic Position Controller
Elektropneumatischer Stellungsregler
Positionneur électropneumatiques



Quickstart

English Deutsch Français

We reserve the right to make technical changes without notice.
Technische Änderungen vorbehalten.
Sous réserve de modifications techniques.

© Bürkert Werke GmbH & Co. KG, 2007 - 2021

Quickstart 2106/08_EU-ML_00805654 / Original DE

1	QUICKSTART	4	7	INSTALLATION	12
1.1	Definition of term / abbreviation	4	7.1	Safety instructions.....	12
1.2	Symbols.....	4	7.2	Installation of the positioner on process valves of series 2103 and 23xx	13
2	AUTHORIZED USE	5	8	PNEUMATIC INSTALLATION	14
3	BASIC SAFETY INSTRUCTIONS	5	9	ELECTRICAL INSTALLATION	15
4	GENERAL INFORMATION	7	9.1	Safety instructions.....	15
4.1	Contact address.....	7	9.2	Electrical installation with circular plug-in connector	15
4.2	Warranty	7	10	START-UP	16
4.3	Information on the internet	7	10.1	Safety instructions.....	16
5	SYSTEM DESCRIPTION	7	10.2	Automatic adjustment X.TUNE	16
5.1	Structure and function.....	7	10.3	Control and display elements.....	18
5.2	Model for control of third-party devices.....	8	11	SAFETY POSITIONS	21
6	TECHNICAL DATA	9	12	ACCESSORIES	22
6.1	Conformity.....	9	12.1	Communications software.....	22
6.2	Standards.....	9	12.2	USB interface	22
6.3	Licenses	9	12.3	Download	22
6.4	Operating conditions.....	9	13	PACKAGING, TRANSPORT, STORAGE	22
6.5	Mechanical data	10			
6.6	Type labels.....	10			
6.7	Pneumatic data	11			
6.8	Electrical data.....	11			
6.9	Factory settings of the positioner.....	12			

1 QUICKSTART

The Quickstart describe the entire life cycle of the device. Keep the Quickstart in a location which is easily accessible to every user and make the Quickstart available to every new owner of the device.

Important Safety Information.

Read Quickstart carefully and thoroughly. Study in particular the chapters entitled “[Basic safety instructions](#)” and “[Authorized use](#)”.

- ▶ Quickstart must be read and understood.

Quickstart explains, for example, how to install and start-up the device.

A detailed description of the device can be found in the operating instructions for positioner Type 8696.



The operating instructions can be found on the Internet at: www.burkert.com

1.1 Definition of term / abbreviation

The term “device” used in these instructions always stands for the positioner Type 8696.

In these instructions, the abbreviation “Ex” always refers to “potentially explosive atmosphere”.

1.2 Symbols

The following symbols are used in these instructions.



DANGER!

Warns of an immediate danger.

- ▶ Failure to observe the warning may result in a fatal or serious injury.



WARNING!

Warns of a potentially dangerous situation.

- ▶ Failure to observe the warning may result in serious injuries or death.



CAUTION!

Warns of a possible danger.

- ▶ Failure to observe this warning may result in a medium or minor injury.

NOTE!

Warns of damage to property.



indicates important additional information, tips and recommendations.



refers to information in these operating instructions or in other documentation.

- ▶ Designates an instruction to prevent risks.

→ designates a procedure that must be carried out.

2 AUTHORIZED USE

Non-authorized use of the positioner Type 8696 may be a hazard to people, nearby equipment and the environment.

- ▶ The device is designed to be mounted on pneumatic actuators of process valves for the control of media.
- ▶ Do not expose the device to direct sunlight.
- ▶ Use according to the authorized data, operating conditions and conditions of use specified in the contract documents and operating instructions. These are described in the chapter entitled [“6 Technical data”](#).
- ▶ The device may be used only in conjunction with third-party devices and components recommended and authorized by Bürkert.
- ▶ In view of the large number of options for use, before installation, it is essential to study and if necessary to test whether the positioner is suitable for the actual use planned.
- ▶ Correct transportation, correct storage and installation and careful use and maintenance are essential for reliable and faultless operation.
- ▶ Use the positioner Type 8696 only as intended.

3 BASIC SAFETY INSTRUCTIONS

These safety instructions do not make allowance for any

- contingencies and events which may arise during the installation, operation and maintenance of the devices.
- local safety regulations – the operator is responsible for observing these regulations, also with reference to the installation personnel.



Risk of injury from high pressure in the equipment/device.

- ▶ Before working on equipment or device, switch off the pressure and deaerate/drain lines.

Risk of electric shock.

- ▶ Before working on equipment or device, switch off the power supply and secure to prevent reactivation.
- ▶ Observe applicable accident prevention and safety regulations for electrical equipment.

General hazardous situations.

To prevent injury, ensure:

- ▶ In the potentially explosive atmosphere the positioner Type 8696 may be used only according to the specification on the separate approval sticker. For use observe the additional instructions enclosed with the device together with safety instructions for the potentially explosive atmosphere.
- ▶ Devices without a separate approval sticker may not be used in a potentially explosive atmosphere.
- ▶ Installation and repair work may be carried out by authorized technicians only and with the appropriate tools.
- ▶ After an interruption in the power supply or pneumatic supply, ensure that the process is restarted in a defined or controlled manner.
- ▶ The device may be operated only when in perfect condition and in consideration of the operating instructions.
- ▶ The general rules of technology apply to application planning and operation of the device.

To prevent damage to property of the device, ensure:

- ▶ Do not feed any aggressive or flammable media into the pilot air port.
- ▶ Do not feed any liquids into the pilot air port.
- ▶ When unscrewing and screwing in the body casing or the transparent cap, do not hold the actuator of the process valve but the connection housing of Type 8696.
- ▶ Do not put any loads on the housing (e.g. by placing objects on it or standing on it).
- ▶ Do not make any external modifications to the device housings.

NOTE!

Electrostatic sensitive components / modules.

The device contains electronic components which react sensitively to electrostatic discharge (ESD). Contact with electrostatically charged persons or objects is hazardous to these components. In the worst case scenario, they will be destroyed immediately or will fail after start-up.

- ▶ Observe the requirements in accordance with EN 61340-5-1 to minimise or avoid the possibility of damage caused by sudden electrostatic discharge.
- ▶ Also ensure that you do not touch electronic components when the power supply voltage is present.

4 GENERAL INFORMATION

4.1 Contact address

Germany

Bürkert Fluid Control System
Sales Center
Chr.-Bürkert-Str. 13-17
D-74653 Ingelfingen
Tel. + 49 (0) 7940 - 10 91 111
Fax + 49 (0) 7940 - 10 91 448
E-mail: info@burkert.com

International

Contact addresses can be found on the final pages of the printed operating instructions.

And also on the Internet at:

www.burkert.com

4.2 Warranty

The warranty is only valid if the positioner Type 8696 is used as intended in accordance with the specified application conditions.

4.3 Information on the internet

The operating instructions and data sheets for Type 8696 can be found on the Internet at:

www.burkert.com

5 SYSTEM DESCRIPTION

5.1 Structure and function

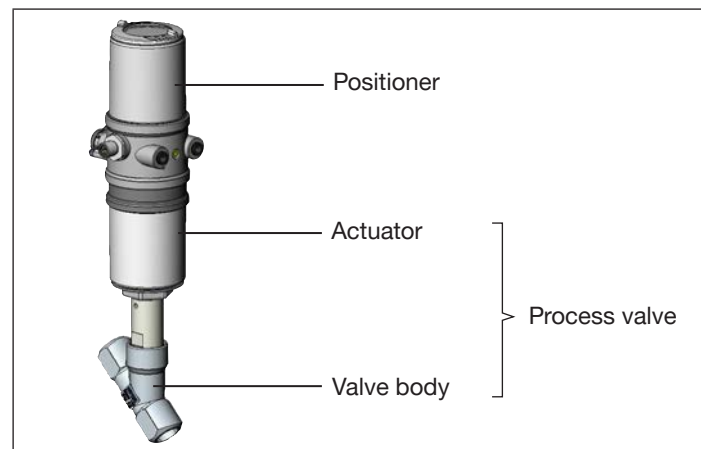

Fig. 1: Structure 1

Positioner Type 8696 is an electropneumatic position controller for pneumatically actuated control valves with single-acting actuators. Together with the pneumatic actuator, the positioner forms a functional unit.

The control valve systems can be used for a wide range of control tasks in fluid technology and, depending on the application conditions, different process valves from the Bürkert range can be combined with the positioner. Angle seat valves, straight seat valves or diaphragm valves of the Type 2300, 2301 or 2103 with an actuator size of 50 mm are suitable.

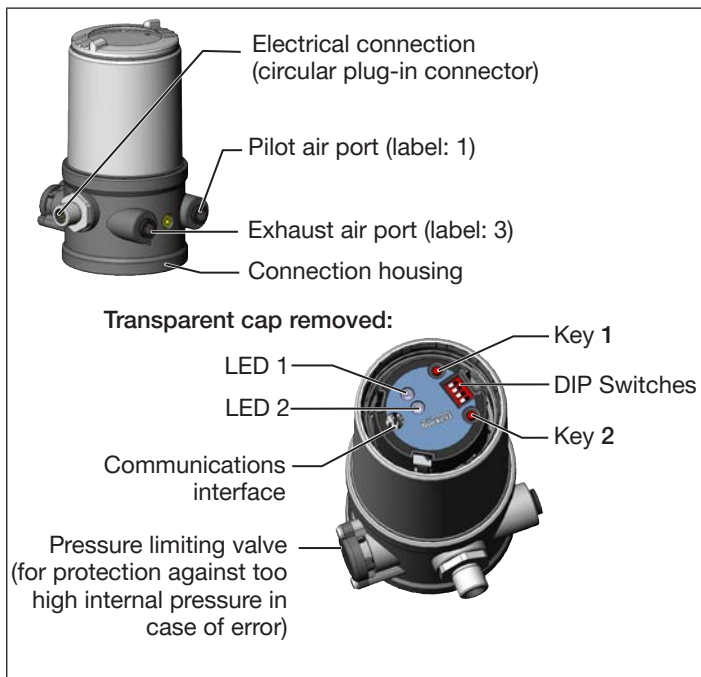

Fig. 2: Structure 2

The position of the actuator is regulated according to the position set-point value. The nominal position value is specified by an external standard signal.

5.2 Model for control of third-party devices

A special model enables the positioner Type 8696 to be attached to third-party devices.

This model has a different pneumatic connection housing so that the pilot air ports can be connected to the outside of the actuator.

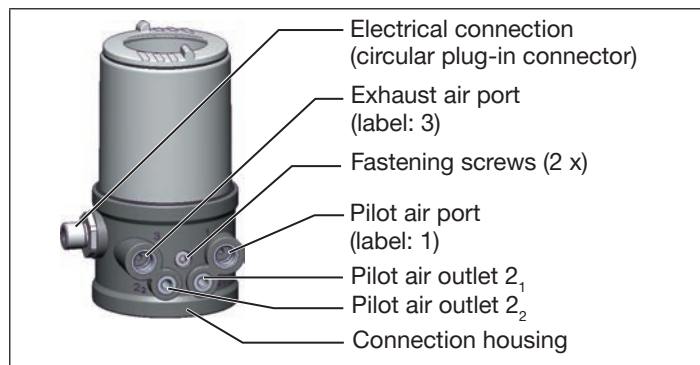

Fig. 3: Model for third-party devices

NOTE!

Damage or malfunction due to ingress of dirt and moisture.

- ▶ To comply with protection class IP65 / IP67, connect the pilot air outlet (only for CFA or CFB) which is not required to the free pilot air port of the third-party device or seal with a plug.

! “In rest position” means that the pilot valves of the positioner Type 8696 are isolated or not actuated.

! If the ambient air is humid, a hose can be connected between pilot air outlet 2_2 of the positioner and the unconnected pilot air port of the third-party device for control function A or control function B. As a result, the spring chamber of the third-party device is supplied with dry air from the vent duct of the positioner.

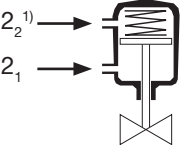
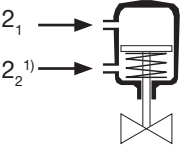
Control function (CF)		Pneumatic connection Type 8696 with third-party device	
A	Process valve closed in rest position (by spring force)	Pilot air outlet	 <p>$2_2^{1)}$ → 2_1 →</p>
B	Process valve open in rest position (by spring force)	Pilot air outlet	 <p>2_1 → $2_2^{1)}$ →</p>

Tab. 1: Pneumatic connection to third-party device

1) Connection optionally, see note.

6 TECHNICAL DATA

6.1 Conformity

In accordance with the EU Declaration of conformity, the positioner Type 8696 is compliant with the EU Directives.

6.2 Standards

The applied standards, which verify conformity with the EU Directives, can be found on the EU-Type Examination Certificate and / or the EU Declaration of Conformity.

6.3 Licenses

The product is approved for use in zone 2 and 22 in accordance with ATEX directive 2014/34/EU category 3GD.

! Observe instructions on operation in an potentially explosive atmosphere (Ex area). Observe the ATEX additional instructions.

The product is cULus approved. Instructions for use in the UL area see chapter “6.8 Electrical data”.

6.4 Operating conditions

! **WARNING!**

Solar radiation and temperature fluctuations may cause malfunctions or leaks.

- ▶ If the device is used outdoors, do not expose it unprotected to the weather conditions.
- ▶ Ensure that the permitted ambient temperature does not exceed the maximum value or drop below the minimum value.

Ambient temperature see type label

Degree of protection:

Evaluated by the manufacturer:	Evaluated by UL:
IP65 / IP67 according to EN 60529 ²⁾	UL Type 4x Rating indoor only ²⁾

Operating altitude: up to 2000 m above sea level

Relative air humidity max. 90% at 55 °C (non condensing)

2) Only if cables, plugs and sockets have been connected correctly and in compliance with the exhaust air concept, see chapter "8 Pneumatic installation".

6.5 Mechanical data

Dimensions See data sheet

Body material exterior: PPS, PC, VA
interior: PA6; ABS

Sealing material EPDM / FKM

Stroke range of valve spindle Series 2103 and 23xx 3 – 32 mm

Third-party devices (modified guide element required) 3 – 40 mm

6.6 Type labels

6.6.1 Type label (example)

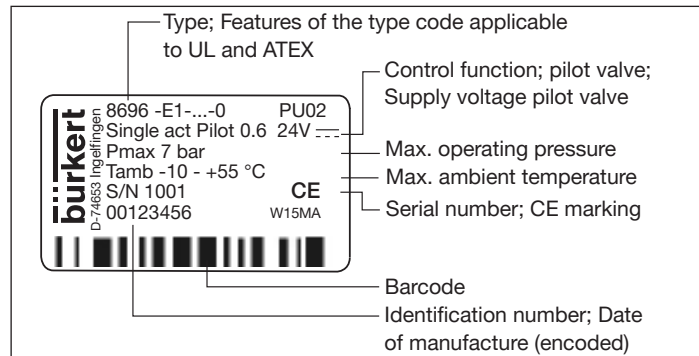

Fig. 4: Type label (example)

6.6.2 UL additional label (example)

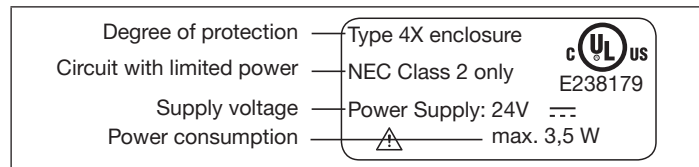

Fig. 5: UL additional label (example)

6.7 Pneumatic data

Control medium:	neutral gases, air Quality classes in accordance with ISO 8573-1
Dust content	Class 7: max. particle size 40 µm, max. particle density 10 mg/m ³
Water content	Class 3: max. pressure dew point - 20 °C or min. 10 °C below the lowest operating temperature
Oil content	Class X: max. 25 mg/m ³
Temperature range control medium:	-10 – +50 °C
Pressure range control medium:	3 – 7 bar
Air output of pilot valve:	7 l _N / min (for aeration and deaeration) (Q _{Nn} - value according to definition for pressure drop from 7 to 6 bar absolute)
Connections:	
23xx / 2103 (Element):	Plug-in hose connector Ø 6mm / 1/4" Socket connection G 1/8
Model third-party device:	Socket connection G 1/8 with M5 connection for connecting to the third-party device

6.8 Electrical data



WARNING!

Only circuits with limited power may be used for UL approved components according to “NEC Class 2”.

Connections	Circular plug-in connector (M12 x 1, 8-pole)
Pilot valve	
Supply voltage	24 V DC ± 10% - max. residual ripple 10 %
Power input	≤ 3.5 W
Input resistance for set-point value signal	180 Ω at 0/4 – 20 mA / 12 bit resolution
Protection class	III as per DIN EN 61140 (VDE 0140-1)
Analogue position feedback max. load for current output 0/4 – 20 mA	560 Ω
Binary input	0 – 5 V = log “0”, 12 – 30 V = log “1” inverted input in reverse order
Communications interface	Direct connection to PC via USB adapter with integrated interface driver, communication with commu- nications software.

6.9 Factory settings of the positioner

Functions can be activated via DIP switches:

Function	Parameter	Value
<i>CUTOFF</i>	Sealing function below Sealing function above	2 % 98 %
<i>CHARACT</i>	Select characteristic	FREE ³⁾
<i>DIR.CMD</i>	Effective direction set-point value	rise

Tab. 2: *Factory settings - functions*



Additional functions are described in the operating instructions Type 8696.

These instructions can be found on the Internet at www.burkert.com.

3) *without change to the settings via the communications software a linear characteristic is stored in FREE.*

7 INSTALLATION



Only for positioner without pre-assembled process valve.

7.1 Safety instructions



DANGER!

Risk of injury from high pressure in the equipment/device.

- ▶ Before working on equipment or device, switch off the pressure and deaerate/drain lines.

Risk of electric shock.

- ▶ Before working on equipment or device, switch off the power supply and secure to prevent reactivation.
- ▶ Observe applicable accident prevention and safety regulations for electrical equipment.



WARNING!

Risk of injury from improper installation.

- ▶ Installation may be carried out by authorized technicians only and with the appropriate tools.

Risk of injury from unintentional activation of the system and an uncontrolled restart.

- ▶ Secure system from unintentional activation.
- ▶ Following assembly, ensure a controlled restart.

7.2 Installation of the positioner on process valves of series 2103 and 23xx

NOTE!

When mounting on process valves with a welded body, follow the installation instructions in the operating instructions for the process valve.

! When the positioner is being installed, the collets of the pilot air ports must not be fitted to the actuator.

NOTE!

Damaged printed circuit board or malfunction.

▶ Ensure that the puck is situated flat on the guide rail.

- Align the puck and the positioner until
1. the puck can be inserted into the guide rail of the positioner (see “Fig. 6”) and
 2. the connection pieces of the positioner can be inserted into the pilot air ports of the actuator (see also “Fig. 7”).

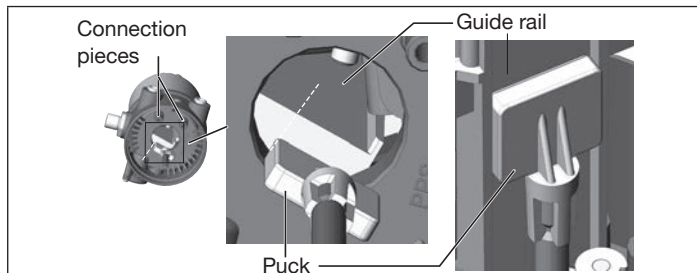

Fig. 6: Aligning the puck

→ Push the positioner, without turning it, onto the actuator until no gap is visible on the form seal.

NOTE!

Too high torque when screwing in the fastening screw does not ensure protection class IP65 / IP67.

▶ The fastening screws may be tightened to a maximum torque of 1.5 Nm only.

→ Attach the positioner to the actuator using the two side fastening screws. In doing so, tighten the screws only hand-tight (max. torque: 1.5 Nm).

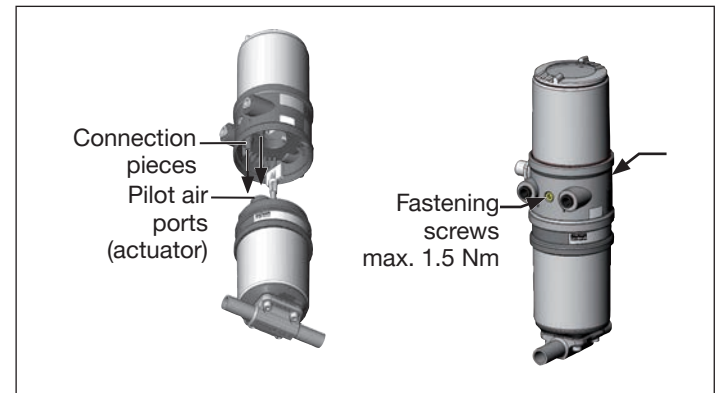

Fig. 7: Installation of positioner, 2103 and 23xx series

8 PNEUMATIC INSTALLATION



DANGER!

Risk of injury from high pressure in the equipment/device.

- ▶ Before working on equipment or device, switch off the pressure and deaerate/drain lines.

Procedure:

- Connect the control medium to the pilot air port (1) (3 – 7 bar; instrument air, free of oil, water and dust).
- Attach the exhaust airline or a silencer to the exhaust air port (3) (see “Fig. 8: Pneumatic connection”).



Keep the adjacent supply pressure **always** at least 0.5 – 1 bar above the pressure which is required to move the actuator to its end position. This ensures that the control behavior is not extremely negatively affected in the upper stroke range on account of too little pressure difference.

During operation keep the fluctuations of the pressure supply as low as possible (max. $\pm 10\%$). If fluctuations are greater, the control parameters measured with the X.TUNE function are not optimum.



Important information for the problem-free functioning of the device:

- ▶ The installation must not cause back pressure to build up.
- ▶ Select a hose for the connection with an adequate cross-section.
- ▶ The exhaust air line must be designed in such a way that no water or other liquid can get into the device through the exhaust air port.

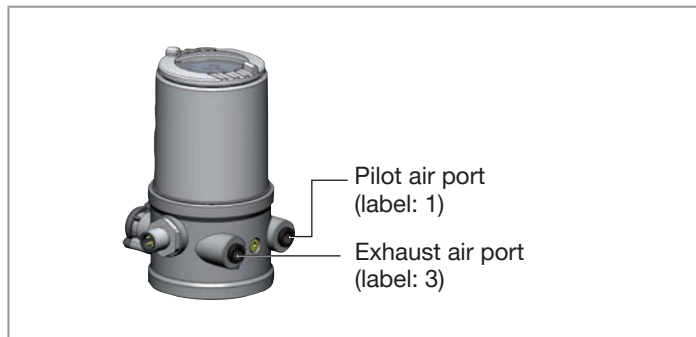

Fig. 8: Pneumatic connection



Caution: (Exhaust air concept):

In compliance with protection class IP67, an exhaust air line must be installed in the dry area.

9 ELECTRICAL INSTALLATION

All electrical inputs and outputs of the device are not galvanically isolated from the supply voltage.

9.1 Safety instructions



DANGER!

Risk of electric shock.

- ▶ Before working on equipment or device, switch off the power supply and secure to prevent reactivation.
- ▶ Observe applicable accident prevention and safety regulations for electrical equipment.



WARNING!

Risk of injury from improper installation.

- ▶ Installation may be carried out by authorized technicians only and with the appropriate tools.

Risk of injury from unintentional activation of the system and an uncontrolled restart.

- ▶ Secure system from unintentional activation.
- ▶ Following installation, ensure a controlled restart.

Minimum temperature rating of the cable to be connected to the field wiring terminals: 75 °C

9.2 Electrical installation with circular plug-in connector

→ Connect the positioner according to the table.

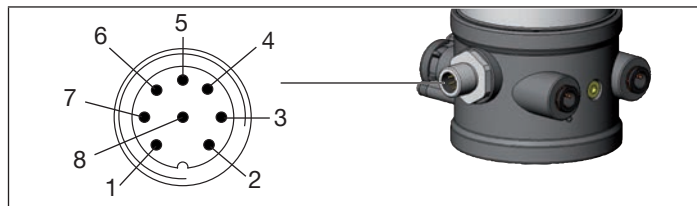



Fig. 9: Circular plug M12 x 1, 8-pole

Input signals of the control center (e.g. PLC)

Pin	Wire color ³⁾	Configuration	External circuit / signal level
1	white	Set-point value + (0/4 – 20 mA)	1 — + (0/4 – 24 mA)
2	brown	Set-point value GND	2 — GND
5	grey	Binary input +	5 — + $\begin{cases} 0 - 5 \text{ V (log. 0)} \\ 10 - 30 \text{ V (log. 1)} \end{cases}$
6	pink	Binary input GND	6 — GND



Tab. 3: Pin assignment - input signals of the control center

Operating voltage

Pin	Wire color ⁴⁾	Configuration	External circuit
3	green	GND	 24 V DC ± 10 % max. residual ripple 10 %
4	yellow	+ 24 V	

Tab. 4: Pin assignment - operating voltage

Output signals to the control center (e.g. PLC) - (required for analogue output option only)

Pin	Wire color ⁴⁾	Configuration	External circuit / signal level
8	red	Analogue position feedback +	8  + (0/4 – 24 mA)
7	blue	Analogue position feedback GND	7  GND

Tab. 5: Pin assignment - output signals of the control center - option

When the supply voltage is applied, the positioner is operating.

→ Actuate the automatic adjustment of the positioner, as described in the chapter entitled [“10.2 Automatic adjustment X.TUNE”](#).

4) The indicated colors refer to the connecting cable available as an accessory (919061).

10 START-UP

10.1 Safety instructions



WARNING!

Risk of injury from improper operation.

Improper operation may result in injuries as well as damage to the device and the area around it.

- ▶ Before start-up, ensure that the operating personnel are familiar with and completely understand the contents of the operating instructions.
- ▶ Observe the safety instructions and intended use.
- ▶ Only adequately trained personnel may operate the equipment/the device.

10.2 Automatic adjustment X.TUNE



To adjust the positioner to local conditions, the X.TUNE function must be run following installation.



WARNING!

Danger due to the valve position changing when the X.TUNE function is running.

When the X.TUNE is running under operating pressure, there is an acute risk of injury.

- ▶ Never run X.TUNE while a process is running.
- ▶ Take appropriate measures to prevent the equipment from being accidentally actuated.

NOTE!

Avoid maladjustment of the controller due to an incorrect pilot pressure or applied operating medium pressure.

- ▶ Run *X.TUNE* **whenever** the pilot pressure (= pneumatic auxiliary energy) is available during subsequent operation.
- Run the *X.TUNE* function preferably without operating medium pressure to exclude interference caused by flow forces.

! To run *X.TUNE*, the positioner must be in the AUTOMATIC operating status (DIP switch 4 = OFF).

NOTE!

Breakage of the pneumatic connection pieces due to rotational impact.

- ▶ When unscrewing and screwing in the transparent cap, do not hold the actuator of the process valve but the connection housing.

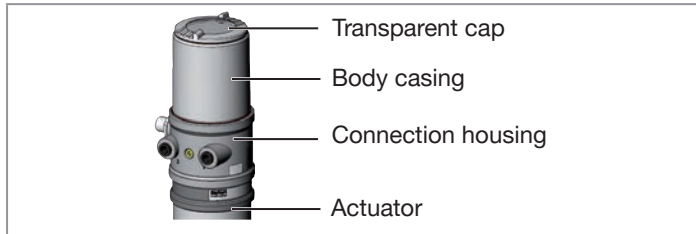

Fig. 10: Open positioner

→ Screw off the transparent cap of the positioner to operate the keys and DIP switches.

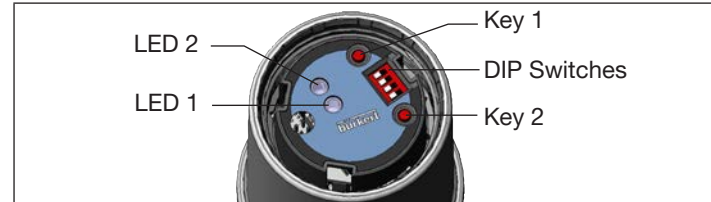

Fig. 11: Starting *X.TUNE*

→ Start the *X.TUNE* by pressing key 1⁵⁾ for 5 s.

While the *X.TUNE* is running, LED 1 flashes quickly (green). When the automatic adjustment is complete, LED 1 flashes slowly (green)⁶⁾. The changes are automatically transferred to the memory (EEPROM) provided the *X.TUNE* function is successful.

5) The *X.TUNE* can also be started via communications software.

6) if a fault occurs, LED 1 is lit red.

NOTE!

Breakage of the pneumatic connection pieces due to rotational impact.

- ▶ When unscrewing and screwing in the transparent cap, do not hold the actuator of the process valve but the connection housing.

Damage or malfunction due to penetration of dirt and humidity.

- ▶ To observe degree of protection IP65 / IP67, screw the transparent cap in all the way.

→ Close the device (assembly tool: 674078⁷⁾).

7) The assembly tool (674078) is available from your Bürkert sales office.

10.3 Control and display elements



A detailed description of the operation and functions of the positioner and the communication software can be found in the respective operating instructions.

NOTE!

Breakage of the pneumatic connection pieces due to rotational impact.

- ▶ When unscrewing and screwing in the transparent cap, do not hold the actuator of the process valve but the connection housing.

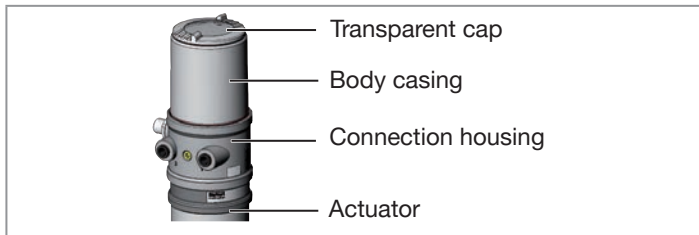

Fig. 12: Open positioner

→ Screw off the transparent cap of the positioner to operate the keys and DIP switches.

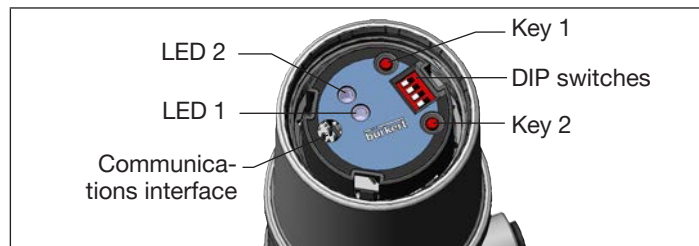

Fig. 13: Description of the control elements

NOTE!

Breakage of the pneumatic connection pieces due to rotational impact.

- ▶ When unscrewing and screwing in the transparent cap, do not hold the actuator of the process valve but the connection housing.

Damage or malfunction due to penetration of dirt and humidity.

- ▶ To observe degree of protection IP65 / IP67, screw the transparent cap in all the way.

→ Close the device (assembly tool: 674078⁸⁾).

8) The assembly tool (674078) is available from your Bürkert sales office.

10.3.1 Operating status

AUTOMATIC (AUTO)

Normal controller mode is implemented and monitored in AUTOMATIC operating state.

LED1 flashes green.

MANUAL (MANU)

In MANUAL operating state the valve can be opened and closed manually via the keys.

LED1 flashes red / green alternately.

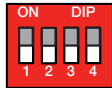

The DIP switch 4 can be used to switch between the two operating states AUTOMATIC and MANUAL.

DIP switches		Function
4	ON	Operating status MANUAL (MANU)
	OFF	Operating status AUTOMATIC (AUTO)

Tab. 6: DIP switches

10.3.2 Functions of the keys

The configuration of the 2 keys on the board varies depending on the operating status (AUTOMATIC / MANUAL).

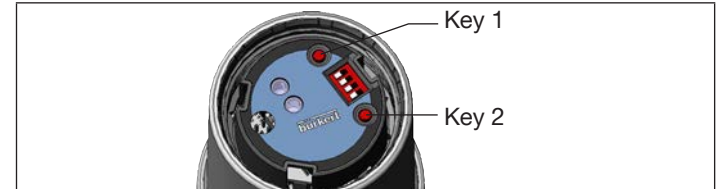

Fig. 14: Keys

MANUAL operating status (DIP switch 4 set to ON):

Key	Function ⁹⁾
1	Aerate (manually open / close the actuator) ¹⁰⁾
2	Deaerate (manually open / close the actuator) ¹⁰⁾

Tab. 7: Configuration of the keys for MANUAL operating status

AUTOMATIC operating status (DIP switch 4 set to OFF):

Key	Function
1	Press for 5 s to start the X.TUNE function
2	-

Tab. 8: Configuration of the keys for AUTOMATIC operating status

9) No function if the binary input was activated with the “Manual/Auto change-over” via the communications software.

10) depending on the operating principle of the actuator.

10.3.3 Function of the DIP switches

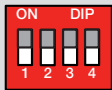
DIP switches		Function	
1	ON	Reversal of the effective direction of the set-point value (set-point value 20 – 4 mA corresponds to position 0 – 100 %), descending (<i>DIR.COMD</i>)	
	OFF	Normal effective direction of the set-point value (set-point value 4 – 20 mA corresponds to position 0 – 100 %), ascending	
2	ON	Sealing function active. The valve completely closes below 2 % ¹⁰⁾ and opens above 98 % of the set-point value (<i>CUTOFF</i>)	
	OFF	No sealing function	
3	ON	Correction characteristic for adjustment of the operating characteristic (linearization of the process characteristic <i>CHARACT</i>) ¹¹⁾	
	OFF	Linear characteristic	
4	ON	Operating status MANUAL (MANU)	
	OFF	Operating status AUTOMATIC (AUTO)	

Tab. 9: DIP switches

¹¹⁾Can be changed via communications software.

10.3.4 Display of the LEDs



Fig. 15: Display of the LEDs

- | | |
|---------------------------|---|
| LED 1
(green / red) | Display of
AUTO, MANU, X.TUNE and FAULT |
| LED 2
(green / yellow) | Display of state of actuator
(open, closed, opens or closes) |

LED 1 (green / red)

LED States		Display
green	red	
on	off	Acceleration phase when Power ON
flashes slowly	off	Operating status AUTO (AUTOMATIC)
flashing alternating	flashing	MANUAL operating status
flashes quickly	off	X.TUNE function
off	on	ERROR (see operating instructions)
flashing slow	flashing	AUTO operating status for sensor break detection

Tab. 10: Display LED 1

LED 2 (green / yellow)

LED States		Display
green	yellow	
on	off	Actuator closed
off	on	Actuator open
flashes slowly	off	Remaining control deviation (actual value > set-point value)
off	flashes slowly	Remaining control deviation (actual value < set-point value)
flashes quickly	off	Closing in MANUAL operating status
off	flashes quickly	Opening in MANUAL operating status

Tab. 11: Display LED 2

11 SAFETY POSITIONS

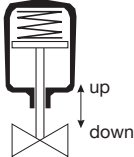
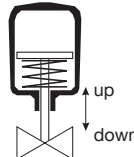
Actuator system	Designation	Safety positions after failure of the auxiliary power	
		electrical	pneumatic
	single-acting Control function A	down	not defined
	single-acting Control function B	up	not defined

Tab. 12: Safety positions

12 ACCESSORIES

Designation	Order no.
USB adapter for connection to a PC in conjunction with an extension cable	227093
Communicator	Information at www.burkert.com
Connection cable M12 x 1, 8-pole	919061
Assembly tool	647078

Tab. 13: Accessories

12.1 Communications software

The PC operating program “Communicator” is designed for communication with the devices from the Bürkert positioner family (valid since serial number 20000).



A detailed description and precise schedule of the procedure for the installation and operation of the software can be found in the associated documentation.

12.2 USB interface

The PC requires a USB interface for communication with the positioners as well as an additional adapter with interface driver (see “Tab. 13”).

12.3 Download

Download the software at: www.burkert.com

13 PACKAGING, TRANSPORT, STORAGE

NOTE!

Transport damages.

Inadequately protected equipment may be damaged during transport.

- ▶ During transportation protect the device against wet and dirt in shock-resistant packaging.
- ▶ Avoid exceeding or dropping below the permitted storage temperature.

Incorrect storage may damage the device.

- ▶ Store the device in a dry and dust-free location.
- ▶ Storage temperature -20 – +65 °C.

Damage to the environment caused by device components contaminated with media.

- ▶ Dispose of the device and packaging in an environmentally friendly manner.
- ▶ Observe applicable regulations on disposal and the environment.

www.burkert.com