

Type 8694 REV.2 Positioner TopControl Basic

Electropneumatic position controller
Elektropneumatischer Stellungsregler
Positionneur électropneumatique



Quickstart

English Deutsch Français

We reserve the right to make technical changes without notice.
Technische Änderungen vorbehalten.
Sous réserve de modifications techniques.

© Bürkert Werke GmbH & Co. KG, 2008-2019

Operating Instructions 1910/01_EU-ML_00815305 / Original DE

1	ABOUT THESE INSTRUCTIONS	4	8	PNEUMATIC INSTALLATION	14
1.1	Symbols.....	4	9	ELECTRICAL INSTALLATION	15
1.2	Definition of terms	4	9.1	Safety instructions.....	15
2	INTENDED USE	5	9.2	Electrical installation without fieldbus communication.....	15
3	BASIC SAFETY INSTRUCTIONS.....	5	9.3	Electrical installation, IO-Link.....	19
4	GENERAL INFORMATION	6	9.4	Electrical installation, bÜS	20
4.1	Contact address.....	6	10	START-UP.....	20
4.2	Warranty.....	6	10.1	Safety instructions.....	20
4.3	Information on the internet.....	6	10.2	Automatic adjustment X.TUNE	20
5	STRUCTURE AND FUNCTION	7	10.3	Setting with Bürkert Communicator.....	22
6	TECHNICAL DATA.....	8	10.4	IO-Link.....	23
6.1	Conformity.....	8	10.5	bÜS.....	24
6.2	Standards.....	8	11	CONTROL AND DISPLAY ELEMENTS.....	24
6.3	Licenses	8	12	SAFETY END POSITIONS	30
6.4	Mechanical data.....	8	13	ACCESSORIES	31
6.5	Type labels.....	8	13.1	Communications software.....	31
6.6	Operating conditions.....	8	14	TRANSPORTATION, STORAGE, DISPOSAL	32
6.7	Pneumatic data	9			
6.8	Electrical data.....	9			
6.9	Factory settings.....	10			
7	INSTALLATION	11			
7.1	Safety instructions.....	11			
7.2	Installing the positioner on process valves belonging to series 2103 and 23xx.....	11			
7.3	Installing the positioner on process valves belonging to series 26xx and 27xx.....	12			

1 ABOUT THESE INSTRUCTIONS

The Quickstart contains extremely important information on the device.

→ Keep these instructions ready to hand at the operation site.



Important safety information.

- ▶ Carefully read these instructions.
- ▶ Observe in particular the safety instructions, intended use and operating conditions.
- ▶ Persons, who work on the device, must read and understand these instructions.



The operating instructions can be found on the Internet at:
www.burkert.com

1.1 Symbols



DANGER!

Warns of an immediate danger.

- ▶ Failure to observe the warning may result in a fatal or serious injury.



WARNING!

Warns of a potentially dangerous situation.

- ▶ Failure to observe the warning may result in serious or fatal injuries.



CAUTION!

Warns of a possible danger.

- ▶ Failure to observe the warning may result in moderate or minor injuries.

ATTENTION!

Warns of damage to property.

- ▶ Failure to observe the warning may result in damage to the device or system.



Indicates important additional information, tips and recommendations.



Refers to information in these instructions or in other documentation.

▶ Designates an instruction to prevent risks.

→ designates a procedure that must be carried out.

✓ Indicates a result.

1.2 Definition of terms

In these instructions the term “device” denotes the following device types: positioner Type 8694 REV.2.

The term “büS” (Bürkert system bus) used in this instruction stands for the communication bus developed by Bürkert and based on the CANopen protocol.

In these instructions, the abbreviation “Ex” always refers to “potentially explosive area”.

2 INTENDED USE

The Positoner Type 8694 REV.2 is designed to be mounted on pneumatic actuators of process valves for the control of media. The permitted fluid media are listed in the technical data.

- ▶ Use the device for its intended purpose only. Non-intended use of the device may be dangerous to people, nearby equipment and the environment.
- ▶ Correct transportation, correct storage as well as correct installation, commissioning, operation and maintenance are essential for reliable and problem-free operation.
- ▶ When using the device, observe the permitted data, operating conditions and application conditions. This information can be found in the contractual documents, the operating instructions and on the type label.
- ▶ Use the device only in conjunction with third-party devices and components recommended and authorized by Bürkert.
- ▶ Do not use the device outdoors without protection from the weather.
- ▶ In areas at risk of explosion, only use devices approved for use in those areas. These devices are labeled with a separate Ex type label. For such use, note the information provided on the separate Ex type label and the additional explosion-related information or separate explosion-related operating instructions.

3 BASIC SAFETY INSTRUCTIONS

These safety instructions do not consider any contingencies or incidents which occur during installation, operation and maintenance. The operator is responsible for observing the location-specific safety regulations, also with reference to the personnel.



DANGER

Risk of injury from high pressure and discharge of medium.

- ▶ Before working on the device or system, switch off the pressure. Vent or drain lines.

Risk of injury from electric shock.

- ▶ Before working on the device or system, switch off the power supply. Secure against reactivation.
- ▶ Observe applicable accident prevention and safety regulations for electrical equipment.

To prevent injury, ensure the following:

- ▶ Secure device or system to prevent unintentional activation.
- ▶ Only trained technicians may perform installation and maintenance work.
- ▶ Perform installation and maintenance with suitable tools only.
- ▶ Do not make any changes to the device and do not subject it to mechanical stress.
- ▶ Operate the device only in perfect state and in consideration of the operating instructions.
- ▶ Observe the general rules of technology.
- ▶ Install the device according to the regulations applicable in the respective country.

- ▶ Do not feed corrosive or flammable media into the device connections.
- ▶ Do not feed any fluids into the connections of the device.
- ▶ After the process is interrupted, restart in a controlled manner. Observe sequence:
 1. Connect electrical or pneumatic power supply.
 2. Charge the device with medium.
- ▶ Observe intended use.

ATTENTION!

Electrostatic sensitive components or modules.

The device contains electronic components which react sensitively to electrostatic discharge (ESD). Contact with electrostatically charged persons or objects is hazardous to these components. In the worst case scenario, they will be destroyed immediately or will fail after start-up.

- ▶ Observe the requirements in accordance with EN 61340-5-1 to minimize or avoid the possibility of damage caused by sudden electrostatic discharge.
- ▶ Also ensure that you do not touch electronic components when the power supply voltage is present.

4 GENERAL INFORMATION

4.1 Contact address

Germany

Bürkert Fluid Control System
Sales Center
Chr.-Bürkert-Str. 13-17
D-74653 Ingelfingen
Tel. + 49 (0) 7940 - 10 91 111
Fax + 49 (0) 7940 - 10 91 448
E-mail: info@burkert.com

International

Contact addresses can be found on the final pages of the printed operating instructions.

And also on the Internet at:

www.burkert.com

4.2 Warranty

The warranty is only valid if the positioner Type 8694 is used as intended in accordance with the specified application conditions.

4.3 Information on the internet

The operating instructions and data sheets for Type 8694 can be found on the Internet at:

www.burkert.com

5 STRUCTURE AND FUNCTION

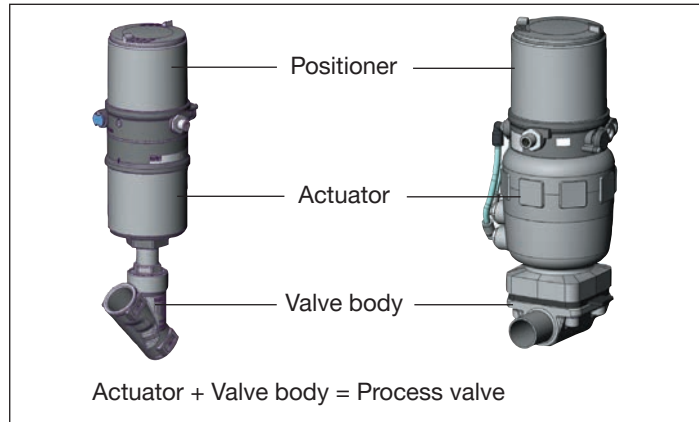

Fig. 1: Structure 1

Positioner Type 8694 is an electro-pneumatic position controller for pneumatically actuated control valves with single-acting actuators. Together with the pneumatic actuator, the positioner forms a functional unit.

The control valve systems can be used for a wide range of control tasks in fluid technology and, depending on the application conditions, different process valves from the Bürkert range can be combined with the positioner. Angle seat valves, straight seat valves, diaphragm valves or ball valves are suitable.

The position of the actuator is regulated according to the position set-point value. The nominal position value is specified by an external standard signal.

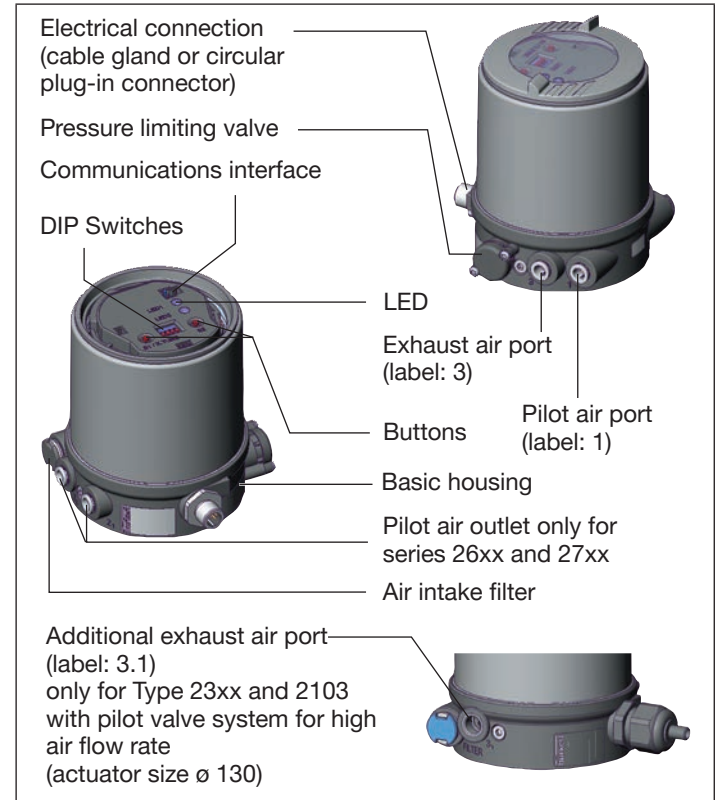

Fig. 2: Structure 2

6 TECHNICAL DATA

6.1 Conformity

In accordance with the EU Declaration of conformity, the positioner Type 8694 is compliant with the EU Directives.

6.2 Standards

The applied standards, which verify conformity with the EU Directives, can be found on the EU-Type Examination Certificate and / or the EU Declaration of Conformity.

6.3 Licenses

The product is approved for use in zone 2 and 22 in accordance with ATEX directive 2014/34/EU category 3GD.



Observe instructions on operation in an explosion-risk (Ex) area. Observe the ATEX additional instructions.

The product is cULus approved. Instructions for use in the UL area see chapter “6.8 Electrical data”.

6.4 Mechanical data

Dimensions	See data sheet
Housing material	exterior: PPS, PC, VA, interior: PA 6; ABS
Sealing material	EPDM / (NBR)
Stroke range of valve spindle	2 – 45 mm

6.5 Type labels

Type label:

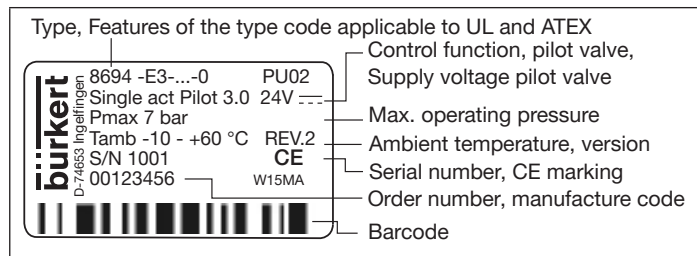

Fig. 3: UL type label (example)

UL additional label:

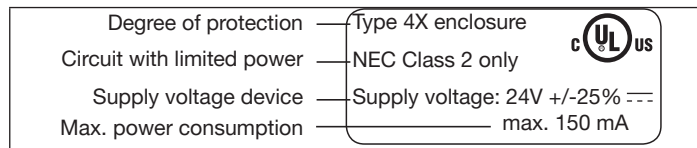

Fig. 4: UL additional label (example)

6.6 Operating conditions



WARNING!

Solar radiation and temperature fluctuations may cause malfunctions or leaks.

- ▶ If the device is used outdoors, do not expose it unprotected to the weather conditions.
- ▶ Ensure that the permitted ambient temperature does not exceed the maximum value or drop below the minimum value.

Ambient temperature see type label

Degree of protection

Evaluated by the manufacturer:	Evaluated by UL:
IP65 / IP67 according to EN 60529*	UL Type 4x Rating*

Operating altitude up to 2000 m above sea level

* Only if cables, plugs and sockets have been connected correctly and in compliance with the exhaust air concept see chapter [“8 Pneumatic installation”](#).

6.7 Pneumatic data

Control medium neutral gases, air
Quality classes in accordance with ISO 8573-1

Dust content Class 7: max. particle size 40 µm,
max. particle density 10 mg/m³

Water content Class 3: max. pressure dew point
-20 °C or min. 10 °C below the
lowest operating temperature

Oil content Class X: max. 25 mg/m³

Temperature range -10 – +50 °C

Pressure range 3 – 7 bar

Air output of pilot valve 7 I_N/min (for aeration and deaeration)
(Q_{Nn} - value according to definition
for pressure drop from 7 to 6 bar
absolute)
optional: 130 I_N/min (for aeration and
deaeration, single-acting)

Connections

Plug-in hose connector Ø 6 mm (1/4")
Socket connection G1/8

6.8 Electrical data



WARNING!

Only circuits with limited power may be used for UL approved components according to “NEC Class 2”.

6.8.1 Electrical data, without field bus communication

Protection class III as per DIN EN 61140 (VDE 0140-1)

Connections Cable gland M16 x 1.5, wrench size 22
(clamping area 5 – 10 mm)
with screw-type terminals for cable
cross-sections 0.14 – 1.5 mm²
Circular plug-in connector
(M12 x 1, 8-pole)

Operating voltage 24 V DC ± 25 %,
max. residual ripple 10 %

Power consumption max. 3,5 W

Input resistance for
set-point value signal 75 Ω at 0/4 – 20 mA /
12 bit resolution

Analogue position
feedback, max. load
for current output
0/4 – 20 mA 560 Ω

Digital input	0 – 5 V = log “0”, 12 – 30 V = log “1” inverted input in reverse order
Communications interface	Connection to PC via USB bus interface set
Communication software	Bürkert Communicator

6.8.2 Electrical data, IO-Link

Protection class	III as per DIN EN 61140 (VDE 0140-1)
Connection	Circular plug-in connector M12 x 1, 5-pin, A-coded, Port Class B
Operating voltage	
System supply (Pin 1+3)	24 V DC $\pm 25\%$ (according to specification)
Actuator supply (Pin 2+5) ¹⁾	24 V DC $\pm 25\%$ (according to specification)
Current consumption	
System supply (Pin 1+3)	max. 50 mA
Actuator supply (Pin 2+5)	max. 100 mA
Total power consumption	max. 3,5 W

1) Actuator supply is galvanically isolated from system supply in accordance with IEC 60664 and for electrical safety in accordance with SELV from IEC 61010-2-201

6.8.3 Electrical data, bÜS

Protection class	III as per DIN EN 61140 (VDE 0140-1)
Connection	Circular plug-in connector M12 x 1, 5-pin, A-coded
Operating voltage	24 V DC $\pm 25\%$
Current consumption	max. 150 mA
Total power consumption	max. 3,5 W

6.9 Factory settings

Function	Parameter	Value
CUTOFF	Sealing function below	2 %
	Sealing function above	98 %
CHARACT	Characteristic correction	FREE ²⁾
DIR.CMD	Reversal of the effective direction set-point value	Off

Tab. 1: Functions



Additional functions are described in the operating instructions Type 8694 REV.2.

These instructions can be found on the Internet at www.burkert.com.

2) Without change to the settings via the communications software a linear characteristic is stored in FREE.

7 INSTALLATION

 Only for positioner without pre-assembled process valve.

7.1 Safety instructions

 **DANGER!**

Risk of injury from high pressure in the equipment/device.

- ▶ Before working on equipment or device, switch off the pressure and deaerate/drain lines.

Risk of electric shock.

- ▶ Before working on equipment or device, switch off the power supply and secure to prevent reactivation.
- ▶ Observe applicable accident prevention and safety regulations for electrical equipment.

 **WARNING!**

Risk of injury from improper installation.

- ▶ Installation may be carried out by authorized technicians only and with the appropriate tools.

Risk of injury from unintentional activation of the system and an uncontrolled restart.

- ▶ Secure system from unintentional activation.
- ▶ Following assembly, ensure a controlled restart.

7.2 Installing the positioner on process valves belonging to series 2103 and 23xx

ATTENTION!

When mounting on process valves with a welded connection, follow the installation instructions in the operating instructions for the process valve.

 When the positioner is being installed, the collets of the pilot air ports must not be fitted to the actuator.

- Align the puck and the positioner until
1. the puck can be inserted into the guide rail of the positioner (see “Fig. 5”) and
 2. the connection pieces of the positioner can be inserted into the pilot air ports of the actuator (see also “Fig. 5”).

ATTENTION!

Damaged printed circuit board or malfunction.

- ▶ Ensure that the puck is situated flat on the guide rail.

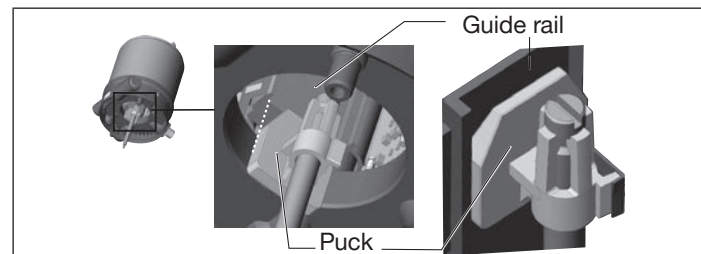

Fig. 5: Aligning the puck

→ Push the positioner, without turning it, onto the actuator until no gap is visible on the form seal.

ATTENTION!

Too high torque when screwing in the fastening screw does not ensure degree of protection IP65 / IP67.

- ▶ The fastening screws may be tightened to a maximum torque of 1.5 Nm only.

→ Attach the positioner to the actuator using the two side fastening screws. In doing so, tighten the screws only hand-tight (max. torque: 1.5 Nm).

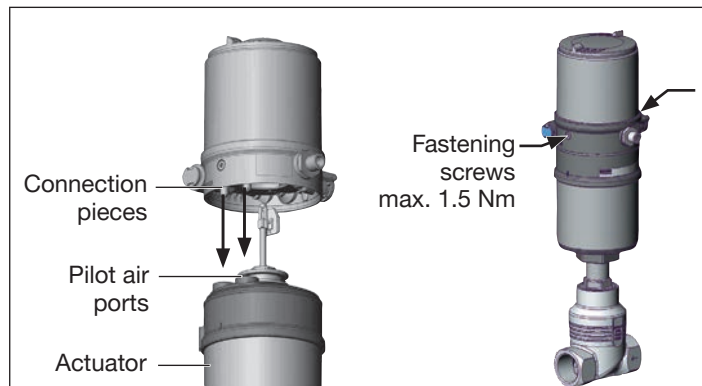

Fig. 6: Installing the positioner, series 2103, 2300 and 2301

7.3 Installing the positioner on process valves belonging to series 26xx and 27xx

Procedure:

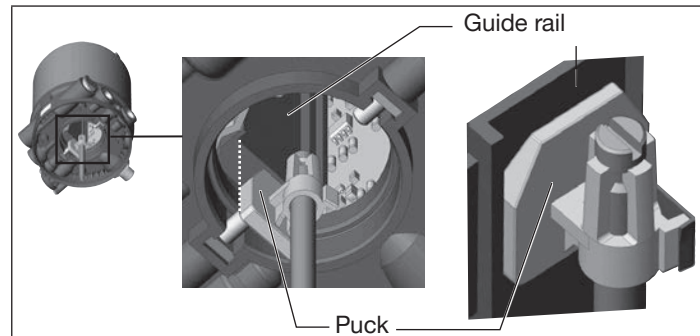

Fig. 7: Aligning the puck

→ Push the positioner onto the actuator. The puck must be aligned in such a way that it is inserted into the guide rail of the positioner.

ATTENTION!

Damaged printed circuit board or malfunction.

- ▶ Ensure that the puck is situated flat on the guide rail.

→ Press the positioner all the way down as far as the actuator and turn it into the required position.



Ensure that the pneumatic connections of the positioner and those of the actuator are situated preferably vertically one above the other (see “Fig. 8”).

ATTENTION!

Too high torque when screwing in the fastening screw does not ensure degree of protection IP65 / IP67.

- ▶ The fastening screws may be tightened to a maximum torque of 1.5 Nm only.
- Attach the positioner to the actuator using the two side fastening screws. In doing so, tighten the screws only hand-tight (max. torque: 1.5 Nm).

ATTENTION!

Damage or malfunction due to ingress of dirt and moisture.

To observe degree of protection IP65 / IP67:

- ▶ In the case of actuator size $\varnothing 80$, $\varnothing 100$ connect the pilot air outlet which is not required to the free pilot air port of the actuator or seal with a plug.
- ▶ In the case of actuator size $\varnothing 125$ seal the pilot air outlet 2_2 which is not required with a plug and feed the free pilot air port of the actuator via a hose into a dry environment.

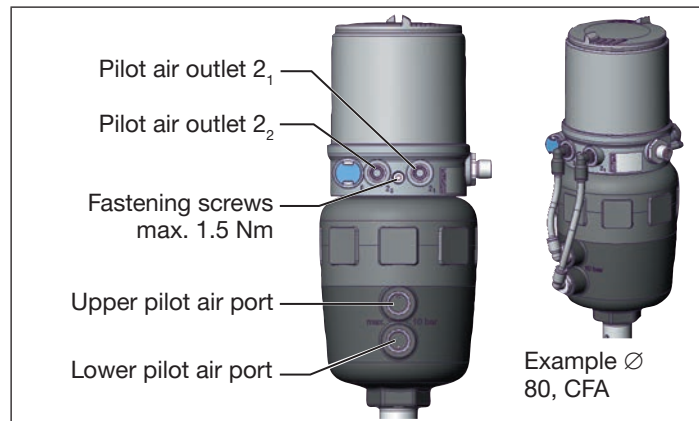
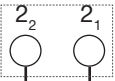
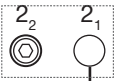
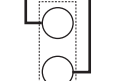
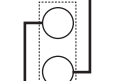
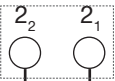
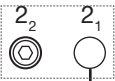
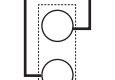
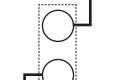

Fig. 8: Installing the pneumatic connection to actuator, series 26xx and 27xx

- Make the pneumatic connection between the positioner and actuator with the “[Tab. 2: Pneumatic connection to actuator](#)”.



“In rest position” means that the pilot valves of the positioner Type 8694 are isolated or not actuated.

Control function A (CFA)		Process valve closed in rest position (by spring force)	
Actuator size		Ø 80, Ø 100	
		Ø 125	
Positioner	Pilot air outlet		
	Actuator		
	Upper pilot air port		
	Lower pilot air port		
Dry area			
Control function B (CFB)		Process valve open in rest position (by spring force)	
Actuator size		Ø 80, Ø 100	
		Ø 125	
Positioner	Pilot air outlet		
	Actuator		
	Upper pilot air port		
	Lower pilot air port		
Dry area			

Tab. 2: Pneumatic connection to actuator

8 PNEUMATIC INSTALLATION



DANGER!

Risk of injury from high pressure in the equipment/device.

- ▶ Before working on equipment or device, switch off the pressure and deaerate/drain lines.

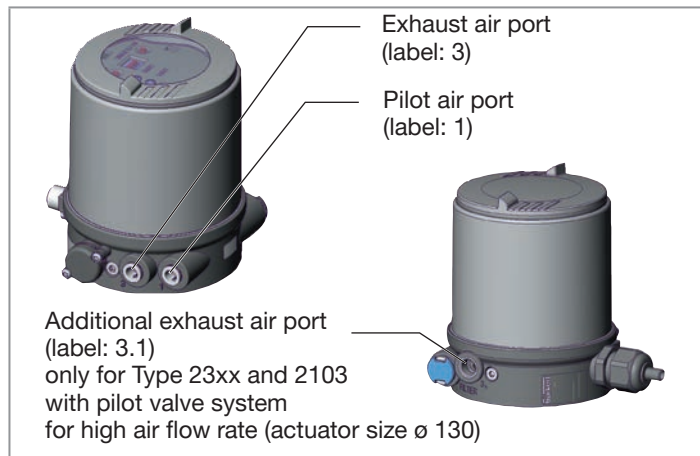

Fig. 9: Pneumatic connection

Procedure:

- Connect the control medium to the pilot air port (1) (3 – 7 bar; instrument air, free of oil, water and dust).
- Attach the exhaust air line or a silencer to the exhaust air port (3) and, if available to the exhaust air port (3.1) (see “Fig. 9”).



Important information for the problem-free functioning of the device:

- ▶ The installation must not cause back pressure to build up.
- ▶ Select a hose for the connection with an adequate cross-section.
- ▶ The exhaust air line must be designed in such a way that no water or other liquid can get into the device through the exhaust air port (3) or (3.1).
- ▶ Keep the adjacent supply pressure **always** at least 0.5 – 1 bar above the pressure which is required to move the actuator to its end position. This ensures that the control behavior is not extremely negatively affected in the upper stroke range on account of too little pressure difference.
- ▶ During operation keep the fluctuations of the pressure supply as low as possible (max. $\pm 10\%$). If fluctuations are greater, the control parameters measured with the *X.TUNE* function are not optimum.



Exhaust air concept:

- ▶ In compliance with degree of protection IP67, an exhaust air line must be installed in the dry area.

9 ELECTRICAL INSTALLATION

All electrical inputs and outputs of the device are not galvanically isolated from the supply voltage.

9.1 Safety instructions



DANGER!

Risk of electric shock.

- ▶ Before working on equipment or device, switch off the power supply and secure to prevent reactivation.
- ▶ Observe applicable accident prevention and safety regulations for electrical equipment.



WARNING!

Risk of injury from improper installation.

- ▶ Installation may be carried out by authorized technicians only and with the appropriate tools.

Risk of injury from unintentional activation of the system and an uncontrolled restart.

- ▶ Secure system from unintentional activation.
- ▶ Following installation, ensure a controlled restart.

9.2 Electrical installation without fieldbus communication

Two kinds of connections are used for the electrical bonding of the positioner:

- Cable gland with screw-type terminals
- Multi-pole with circular plug-in connector M12 x 1, 8-pole

9.2.1 Electrical installation with cable gland

ATTENTION!

Breakage of the pneumatic connection pieces due to rotational impact.

- ▶ When unscrewing and screwing in the body casing, do not hold the actuator of the process valve but the basic housing.

→ Unscrew the body casing (stainless steel) in a counter-clockwise direction.

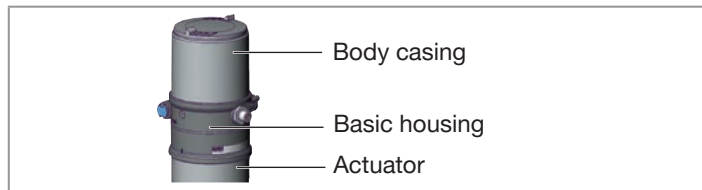

Fig. 10: Open positioner

→ Push the cables through the cable gland.

→ Connect the wires.

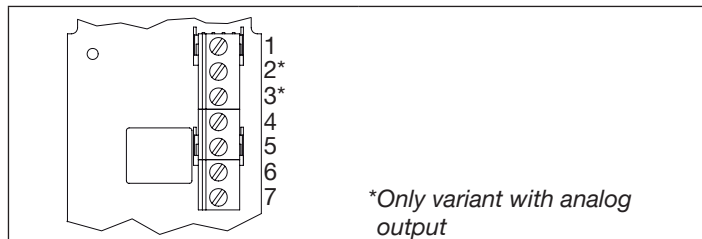

Fig. 11: Screw-type terminals

Input signals from the control centre (e.g. PLC)

Terminal	Configuration	External circuit, signal level
4	Set-point value +	4 ○ — + (0/4 – 20 mA)
5	Set-point value GND	5 ○ — GND see chapter “Connection type 3-wire or 4-wire”
1	Digital input +	1 ○ — + $\begin{cases} 0 - 5 \text{ V (log. 0)} \\ 10 - 30 \text{ V (log. 1)} \end{cases}$ with reference to terminal 7 (GND)

Tab. 3: Assignment of screw-type terminals, input signals

Operating voltage

Terminal	Configuration	External circuit
6	Operating voltage +	6 ○ — 24 V DC ± 25 %
7	Operating voltage GND	7 ○ — max. residual ripple 10 %

Tab. 4: Assignment of screw-type terminals, operating voltage

Output signals to the PLC (for analog output variant)

Terminal	Configuration	External circuit, signal level
2	Analogue position feedback +	2 ○ — + (0/4 – 20 mA)
3	Analogue position feedback GND	3 ○ — GND

Tab. 5: Assignment of screw-type terminals, output signals to the PLC

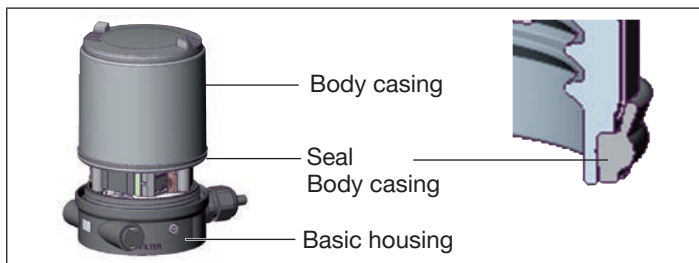

Fig. 12: Position of the seal in the body casing

→ Check that the seal is correctly positioned in the body casing.

ATTENTION!

Breakage of the pneumatic connection pieces due to rotational impact.

- ▶ When unscrewing and screwing in the body casing, do not hold the actuator of the process valve but the basic housing.

Damage or malfunction due to penetration of dirt and humidity.

To ensure degree of protection IP65 / IP67:

- ▶ Tighten the union nut on the cable gland according to the cable size or dummy plugs used (approx. 1.5 Nm).
- ▶ Screw the body casing in all the way.

→ Tighten union nut on the cable gland (torque approx. 1.5 Nm).

→ Close the device (assembly tool: 674077³⁾).

3) The assembly tool (674077) is available from your Bürkert sales office.

9.2.2 Connection type 3-wire or 4-wire

Setting via communication software

Connection type 4-wire (factory setting)

The set-point value input is designed as a differential input, i.e. the GND lines of the set-point value input and the supply voltage are not identical.

Note: If the GND signals of the set-point value input and the supply voltage are connected, the 3-wire connection type must be set in the software.

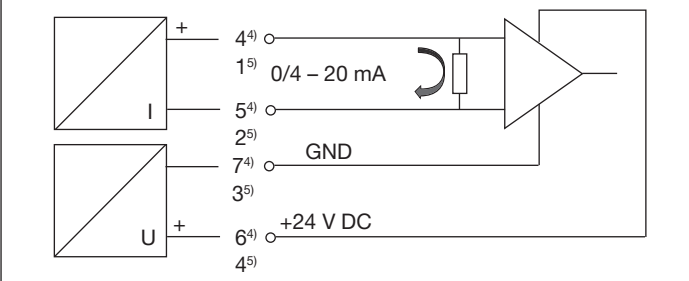

Tab. 6: Connection type 4-wire

4) Terminal no. for connection with cable gland

5) Pin no. for connection with round plug connector

Connection type 3-wire

The set-point value input is related to the GND line of the supply voltage, i.e. setpoint input and supply voltage have a common GND line.

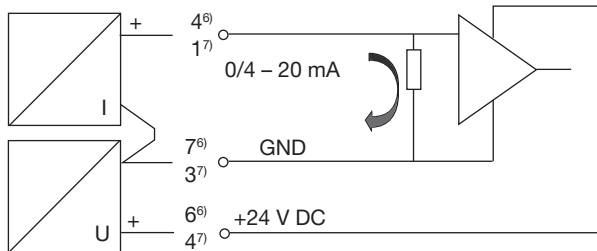

Tab. 7: Connection type 3-wire

6) Terminal no. for connection with cable gland

7) Pin no. for connection with round plug connector

9.2.3 Electrical installation 24 V DC with circular plug-in connector

→ Connect the positioner according to the table.

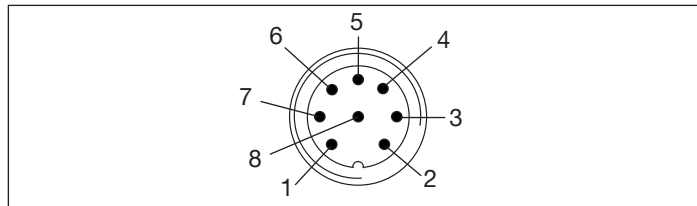

Fig. 13: Circular plug M12 x 1, 8-pole

Input signals of the control center (e.g. PLC)

Pin	Wire color ⁶⁾	Configuration	External circuit / signal level
1	white	Set-point value + (0/4 ... 20 mA)	1 — + (0/4 – 20 mA)
2	brown	Set-point value GND	2 — GND see chapter “Connection type 3-wire or 4-wire”
5	grey	Digital input +	5 — + $\begin{cases} 0 - 5 \text{ V (log. 0)} \\ 10 - 30 \text{ V (log. 1)} \end{cases}$
6	pink	Digital input GND	identical to Pin 3 (GND)

Tab. 8: Pin assignment, input signals of the control center

Operating voltage

Pin	Wire color ⁸⁾	Configuration	External circuit
3	green	GND	<p>24 V DC \pm 25 % max. residual ripple 10 %</p>
4	yellow	+ 24 V	

Tab. 9: Pin assignment, operating voltage

Output signals to the control center (e.g. PLC) - (required for analogue output option only)

Pin	Wire color ⁸⁾	Configuration	External circuit / signal level
8	red	Analogue position feedback +	8 + (0/4 – 20 mA)
7	blue	Analogue position feedback GND	7 GND

Tab. 10: Pin assignment, output signals of the control center (option)

8) The indicated colors refer to the connecting cable available as an accessory (919061).

9.3 Electrical installation, IO-Link

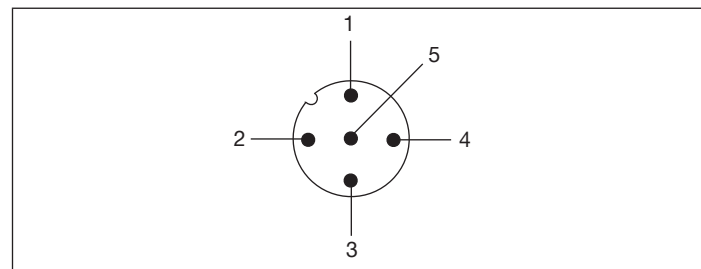

Fig. 14: Pin assignment, Port Class B

Pin	Designation	Configuration	
1	L +	24 V DC	System supply
2	2 L +	24 V DC	Actuator supply
3	L -	0 V (GND)	System supply
4	C/Q	IO-Link	
5	2 M	0 V (GND)	Actuator supply

Tab. 11: Pin assignment

9.4 Electrical installation, bÜS

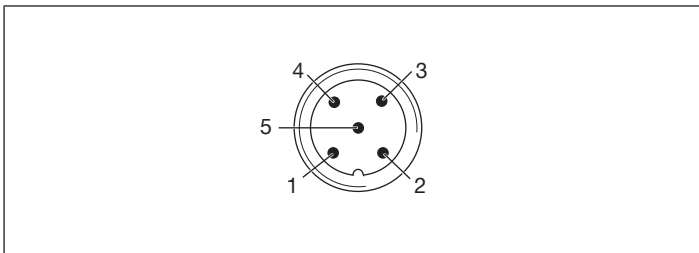

Fig. 15: Pin assignment

Pin	Wire color	Configuration
1	CAN plate/shielding	CAN plate/shielding
2	red	+24 V DC $\pm 25\%$, max. residual ripple 10 %
3	black	GND / CAN_GND
4	white	CAN_H
5	blue	CAN_L

Tab. 12: Pin assignment



For electrical installation with bÜS network, note:

Use a 5-pin round plug and shielded 5-core cable.

The shielding in the device is not connected to the functional earth.

10 START-UP

10.1 Safety instructions



WARNING!

Risk of injury from improper operation.

Improper operation may result in injuries as well as damage to the device and the area around it.

- ▶ Before start-up, ensure that the operating personnel are familiar with and completely understand the contents of the operating instructions.
- ▶ Observe the safety instructions and intended use.
- ▶ Only adequately trained personnel may operate the equipment/the device.

10.2 Automatic adjustment X.TUNE



To adjust the positioner to local conditions, the X.TUNE function must be run following installation.



WARNING!

Danger due to the valve position changing when the X.TUNE function is running.

When the X.TUNE is running under operating pressure, there is an acute risk of injury.

- ▶ Never run X.TUNE while a process is running.
- ▶ Take appropriate measures to prevent the equipment from being accidentally actuated.

ATTENTION!

Avoid maladjustment of the controller due to an incorrect pilot pressure or applied operating medium pressure.

- ▶ Run *X.TUNE* **whenever** the pilot pressure (= pneumatic auxiliary energy) is available during subsequent operation.
- Run the *X.TUNE* function preferably **without** operating medium pressure to exclude interference caused by flow forces.

ATTENTION!

Breakage of the pneumatic connection pieces due to rotational impact.

- ▶ When unscrewing and screwing in the transparent cap, do not hold the actuator of the process valve but the basic housing.

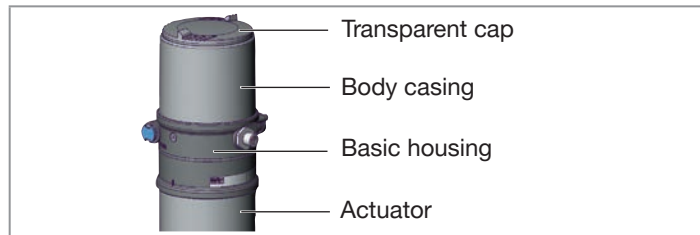

Fig. 16: Open positioner

- Screw off the transparent cap of the positioner to operate the keys and DIP switches.

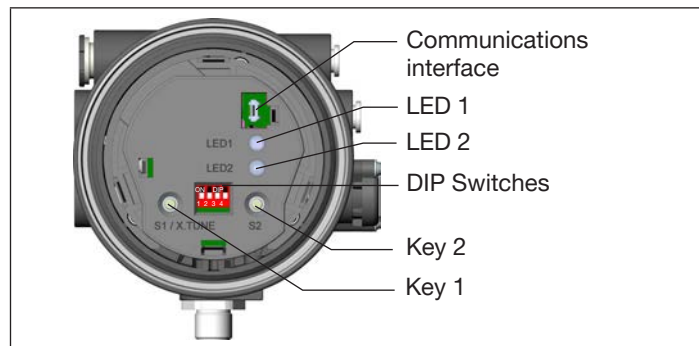

Fig. 17: Automatic adjustment *X.TUNE*

- ! To run *X.TUNE*, the positioner must be in the AUTOMATIC operating status (DIP switch 4 = OFF).

→ Start the *X.TUNE* by pressing key 1⁹⁾ for 5 s.

LED 2 flashes at 5 Hz. The device is in the NAMUR state function check, LED 1 lights orange.

If the *X.TUNE* is successfully completed, the NAMUR state is reset again. The changes are automatically transferred to the memory (EEPROM) provided the *X.TUNE* function is successful.

When LED 1 lights red after *X.TUNE*:

- Execute *X.TUNE* again.
- Perform a device restart if necessary.

9) The *X.TUNE* can also be started via communications software.

ATTENTION!

Breakage of the pneumatic connection pieces due to rotational impact.

- ▶ When unscrewing and screwing in the transparent cap, do not hold the actuator of the process valve but the basic housing.

Damage or malfunction due to penetration of dirt and humidity.

- ▶ To observe degree of protection IP65 / IP67, screw the transparent cap in all the way.

→ Close the device (assembly tool: 674077¹⁰⁾).

10.3 Setting with Bürkert Communicator

The Bürkert Communicator can be used to make all settings on the device.



The settings in the Bürkert Communicator can be found in the operating manual.

10.3.1 Connecting IO-Link device with Bürkert Communicator

Required components:

- Communications software: Bürkert Communicator for PC
- büS standard set (see accessories)
- büS adapter for büS service interface (see accessories)
- If necessary, a büS cable extension (see accessories)

ATTENTION

Breakage of the pneumatic connection pieces due to rotational impact.

- ▶ When opening or closing the device, do not press against the actuator, but against the basic housing.

→ Screw off the transparent cap by turning counterclockwise.

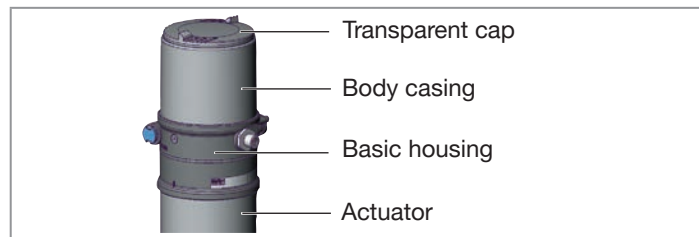

Fig. 18: Open positioner

¹⁰⁾The assembly tool (674077) is available from your Bürkert sales office.

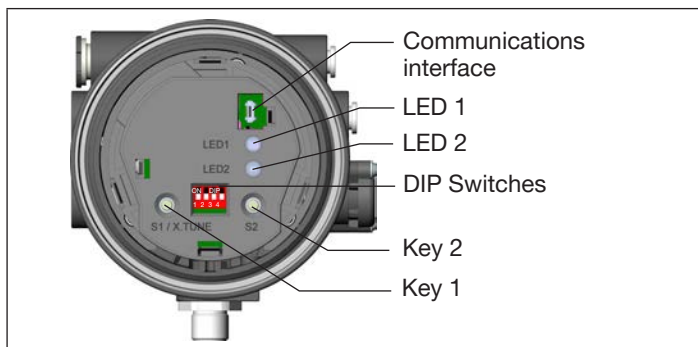

Fig. 19: Automatic adjustment X.TUNE

- Insert micro USB plug in büS service interface.
- Establish connection to PC with büS stick.
- Starting Bürkert Communicator.
- Implementing settings.

10.3.2 Connecting büS device with Bürkert Communicator

Required components:

- Communications software: Bürkert Communicator for PC
- büS standard set (see accessories)

- Establish connection to PC with büS stick.
- Starting Bürkert Communicator.
- Implementing settings.

10.4 IO-Link

10.4.1 Information, IO-Link

IO-Link is an internationally standardized IO technology (IEC 61131-9) to enable sensors and actuators to communicate.

IO-Link is a point-to-point communication with 3-wire connection technology for sensors and actuators and unshielded standard sensor cables.

To ensure clear communication, the IO-Link devices should not be parameterised simultaneously by the higher-level controller (PLC) via the IO-Link master and with the Bürkert Communicator (via the service

10.4.2 interface). Technical specifications, IO-Link

IO-Link specifications	V1.1.2
Supply	via IO-Link (M12 x 1, 5-pin, A-coded)
Port Class	B
SIO mode	no
IODD file	see Internet
VendorID	0x0078, 120
DeviceID	see IODD file
ProductID	8694
Transmission speed	COM3 (230.4 kbit/s)
PD Input Bits	80
PD Output Bits	40
M-sequence Cap.	0x0D
Min. cycle time	5 ms

Data storage	Yes
Max. cable length	20 m

10.4.3 Configuration of the fieldbus

The required start-up files and the description of the process data and acyclic parameters are available on the Internet.



Download from:
www.burkert.com / Type 8694 / Software

10.5 büS

10.5.1 Information, büS

büS is a system bus developed by Bürkert with a communication protocol based on CANopen.

10.5.2 Configuration of the fieldbus

The required start-up files and the description of objects are available on the Internet.



Download from:
www.burkert.com / Type 8694 / Software

11 CONTROL AND DISPLAY ELEMENTS



A detailed description of the operation and functions of the positioner and the communication software can be found in the respective operating instructions.

ATTENTION!

Breakage of the pneumatic connection pieces due to rotational impact.

- ▶ When unscrewing and screwing in the transparent cap, do not hold the actuator of the process valve but the basic housing.

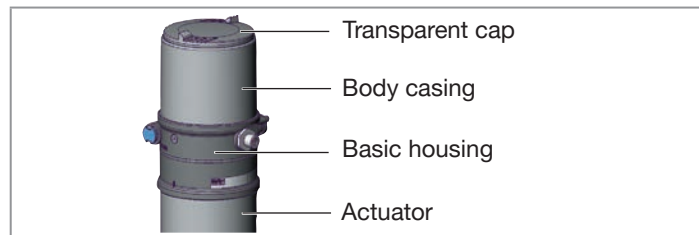

Fig. 20: Open positioner

- Screw off the transparent cap of the positioner to operate the keys and DIP switches.

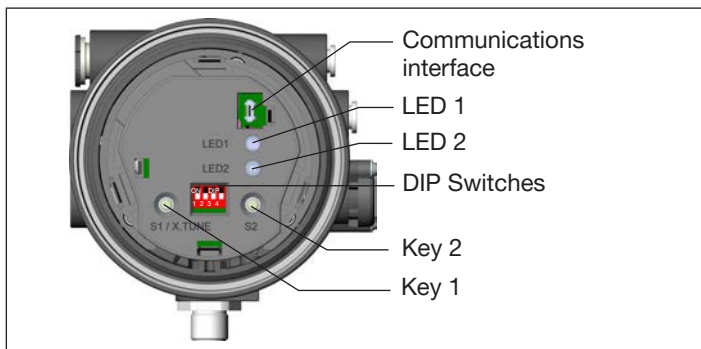

Fig. 21: Description of the control elements

ATTENTION!

Breakage of the pneumatic connection pieces due to rotational impact.

- ▶ When unscrewing and screwing in the transparent cap, do not hold the actuator of the process valve but the basic housing.

Damage or malfunction due to penetration of dirt and humidity.

- ▶ To observe degree of protection IP65 / IP67, screw the transparent cap in all the way.

→ Close the device (assembly tool: 674077¹¹⁾).

¹¹⁾The assembly tool (674077) is available from your Bürkert sales office.

11.5.1 Operating status

AUTOMATIC (AUTO)

Normal controller mode is implemented and monitored in AUTOMATIC operating state.

MANUAL (MANU)

In MANUAL operating state the valve can be opened and closed manually via the keys.

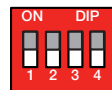

The DIP switch 4 can be used to switch between the two operating states AUTOMATIC and MANUAL.

DIP switches		Function
4	ON	Operating status MANUAL (MANU)
	OFF	Operating status AUTOMATIC (AUTO)

Tab. 13: DIP switches

11.5.2 Functions of the buttons

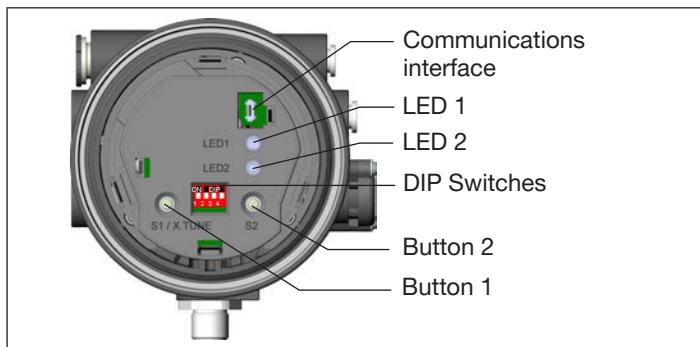

Fig. 22: Keys

The configuration of the 2 buttons on the board varies depending on the operating status (AUTOMATIC / MANUAL).

MANUAL operating status (DIP switch 4 set to ON):

Key	Function
1	Aerate (manually open / close the actuator) ¹³⁾
2	Deaerate (manually open / close the actuator) ¹³⁾
1 and 2 simultaneously	Longer than 10 s (< 30 s, LED 2 flashes at 5 Hz): Device restart
	Longer than 30 s (LED 2 flashes at 10 Hz): Reset device to factory setting

Tab. 14: Configuration of the keys for MANUAL operating status

AUTOMATIC operating status (DIP switch 4 set to OFF):

Key	Function
1	Press for 5 s to start the X.TUNE function
2	-
1 and 2 simultaneously	Longer than 10 s (< 30 s, LED 2 flashes at 5 Hz): Device restart
	Longer than 30 s (LED 2 flashes at 10 Hz): Reset device to factory setting

Tab. 15: Configuration of the keys for AUTOMATIC operating status

12) Depending on the operating principle of the actuator.

11.5.3 Function of the DIP switches

DIP switches		Function	
1	ON	Reversal of the effective direction of the set-point value (set-point value 20 – 4 mA corresponds to position 0 – 100 %), descending (<i>DIR.CMD</i>)	
	OFF	Normal effective direction of the set-point value (set-point value 4 – 20 mA corresponds to position 0 – 100 %), ascending	
2	ON	Sealing function active. The valve completely closes below 2 % ¹⁴⁾ and opens above 98 % of the set-point value (<i>CUTOFF</i>)	
	OFF	No sealing function	
3	ON	Correction characteristic for adjustment of the operating characteristic (linearization of the process characteristic <i>CHARACT</i>) ¹⁴⁾	
	OFF	Linear characteristic	
4	ON	Operating status MANUAL (MANU)	
	OFF	Operating status AUTOMATIC (AUTO)	

Tab. 16: DIP switches

¹³⁾Can be changed via communications software.

11.5.4 Display of the LEDs

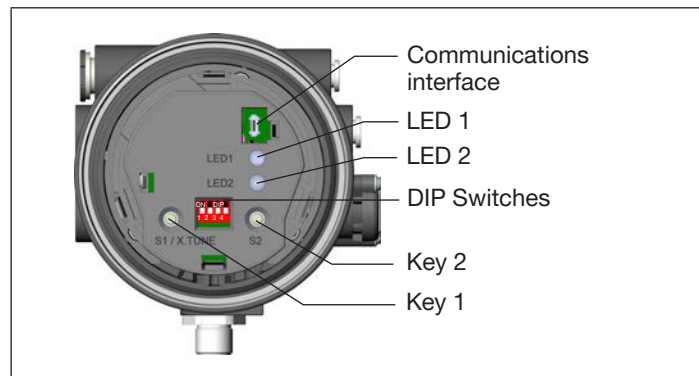

Fig. 23: Display of the LEDs

- | | |
|------------------|---|
| LED 1
(RGB) | Display of the device status and valve position |
| LED 2
(green) | Display of the bus status
Display during functions <ul style="list-style-type: none"> • X.TUNE • Device restart • Reset to factory settings |

11.5.5 Device status display

The device status LED 1 (RGB) show the device status.

The user can set the following LED modes for the display of device status and valve position.

- Valve mode
- Valve mode with warnings (factory setting)
- NAMUR mode
- Fixed color
- LED off

The LED mode and the colors of the valve position can be set with the Bürkert Communicator.

IO-Link:

The LED mode and the colors of the valve position can be also set with an acyclic parameter (see parameter list).



The description for setting the LED mode can be found in the section "Setting the LED mode" in the operating instruction.

11.5.6 Valve mode + warnings

Displays in valve mode + warnings:

- Valve position: open, half-way, closed
- Device status: failure, function check, out of specification, maintenance required (according to NAMUR)

Valve position		Device status
	Status, color	Normal operation
Open	is lit yellow*	--
Half-way	LED off*	--
Closed	is lit green*	--

Valve mode + warnings, normal operation

* Factory setting, selectable colors for the valve position: Off, white, green, blue, yellow, orange, red

If several device statuses exist simultaneously, the device status with the highest priority is displayed.

Valve position	Device status				
	Failure	Function check	Out of specification	Maintenance required	
	Status, color	Status, color	Status, color	Status, color	
Open	flashes red	flashes orange	flashes yellow	blinks blue	alternately with yellow*
Half-way	flashes red	flashes orange	flashes yellow	blinks blue	alternately with LED off*
Closed	flashes red	flashes orange	flashes yellow	flashes blue	alternately with green*

Valve mode + warnings, device status

For warning messages, the LEDs are briefly switched off between the change of the colors.

For localizations, the colors are only shown momentarily.

11.5.7 NAMUR mode

The device status LED show the device status.

The display elements change color in accordance with NAMUR NE 107.

* Factory setting, selectable colors for the valve position: Off, white, green, blue, yellow, orange, red

If several device statuses exist simultaneously, the device status with the highest priority is displayed. The priority is determined by the severity of the deviation from controlled operation (red LED = failure = highest priority).

Status display in accordance with NE 107, edition 2006-06-12			
Color	Color code	Status	Description
Red	5	Outage, error or malfunction	Normal operation is not possible due to a malfunction in the device or on its peripheral equipment.
Orange	4	Function check	Work is being carried out on the device; normal operation is therefore temporarily not possible
Yellow	3	Out of specification	Ambient conditions or process conditions for the device are outside the specified area.
Blue	2	Maintenance required	The device is in normal operation, although a function is briefly restricted. → Service device.
Green	1	Diagnostics active	Device is operating perfectly. Status changes are indicated in different colors. Messages are transmitted via a fieldbus if connected.

Tab. 17: Description of the colors

11.5.8 Status LED, green

LED 2 (green) indicates the following:

Color	Status	Description
green	is lit	
	is not lit	IO-Link communication inactive
	flashes	IO-Link communication active
	flashes with 5 Hz	X.TUNE is running or device is restarted
	flashes with 10 Hz	Device is reset to factory settings

Tab. 18: LED 2, green

12 SAFETY END POSITIONS

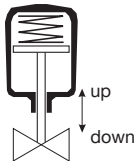
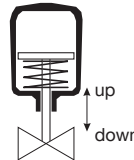
Actuator system	Designation	Safety positions after failure of the auxiliary power	
		electrical	pneumatic
	single-acting Control function A	down	pilot valve system with high air flow rate: down pilot valve system with low air flow rate: not defined
	single-acting Control function B	up	pilot valve system with high air flow rate: up pilot valve system with low air flow rate: not defined

Tab. 19: Safety end positions

13 ACCESSORIES

Designation	Order no.
Special wrench	665702
Wrench for opening or closing the transparent cap	674077
Connection cable M12 x 1, 8-pole	919061
Communication software Bürkert Communicator	Information at www.burkert.com

USB-büS interface set:	
büS standard set (büS stick + 0.7 m cable with M12 plug)	772551
büS adapter for büS service interface (M12 on büS service interface Micro-USB)	773254
büS cable extension (M12 pin to M12 socket), length 1 m	772404
büS cable extension (M12 pin to M12 socket), length 3 m	772405
büS cable extension (M12 pin to M12 socket), length 5 m	772406
büS cable extension (M12 pin to M12 socket), length 10 m	772407

Tab. 20: Accessories

13.1 Communications software

The PC operating program “Communicator” is designed for communication with the devices from the Bürkert positioner family.



A detailed description and precise schedule of the procedure for the installation and operation of the software can be found in the associated documentation.

Download the software at: www.burkert.com

14 TRANSPORTATION, STORAGE, DISPOSAL

ATTENTION!

Damage in transit due to inadequately protected devices.

- ▶ Protect the device against moisture and dirt in shock-resistant packaging during transportation.
- ▶ Observe permitted storage temperature.

ATTENTION!

Incorrect storage may damage the device.

- ▶ Store the device in a dry and dust-free location.
- ▶ Storage temperature: -20 to +65 °C

ATTENTION!

Damage to the environment caused by device components contaminated with media.

- ▶ Dispose of the device and packaging in an environmentally friendly manner.
- ▶ Observe applicable disposal and environmental regulations.



Observe national regulations on the disposal of waste.

www.burkert.com