

# Type 8640 AirLINE

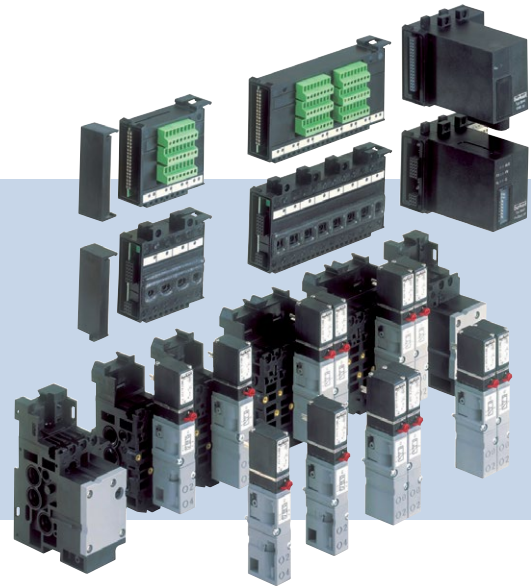

## Quickstart

English    Deutsch    Français

We reserve the right to make technical changes without notice.  
Technische Änderungen vorbehalten.  
Sous réserve de modifications techniques.

© Bürkert Werke GmbH & Co. KG, 2009 - 2019

Operating Instructions 1901/11\_EU-ML\_00804431 / Original DE

<b>1 THE QUICKSTART .....</b>	<b>4</b>	<b>6 TECHNICAL DATA .....</b>	<b>7</b>
1.1 Definition of the Term "Device" .....	4	6.1 Conformity .....	7
1.2 Symbols.....	4	6.2 Standards.....	7
<b>2 INTENDED USE.....</b>	<b>5</b>	6.3 General Technical Data .....	7
2.1 Restrictions.....	5	<b>7 ASSEMBLY .....</b>	<b>8</b>
<b>3 GENERAL SAFETY INFORMATION .....</b>	<b>5</b>	7.1 Safety instructions .....	8
<b>4 GENERAL INFORMATION .....</b>	<b>6</b>	7.2 Assembly.....	9
4.1 Contact address.....	6	<b>8 INSTALLATION .....</b>	<b>12</b>
4.2 Warranty.....	6	8.1 Fluid Installation .....	12
4.3 Informations in the Internet.....	6	8.2 Fluid deinstallation .....	15
<b>5 DEVICE REVISION .....</b>	<b>6</b>	8.3 Electrical Installation.....	15
		<b>9 START-UP .....</b>	<b>19</b>
		<b>10 MAINTENANCE.....</b>	<b>19</b>
		<b>11 TRANSPORT, STORAGE, DISPOSAL.....</b>	<b>19</b>

## 1 THE QUICKSTART

The Quickstart contains the most important information and notes regarding the use of the device. A detailed description can be found in the operating instructions for Type 8640.

Keep the Quickstart in an easily accessible location for each user. The Quickstart must be available to each new owner of the device.

### Important safety information!

- ▶ Carefully read these instructions.
- ▶ Observe in particular the safety instructions, intended use and operating conditions.
- ▶ Persons, who work on the device, must read and understand these instructions.



The operating instructions and data sheets for Bürkert devices can be found on the Internet at: [www.burkert.com](http://www.burkert.com)

### 1.1 Definition of the Term “Device”

In these instructions, the term “device” always refers to the system AirLINE Type 8640.

### 1.2 Symbols

The following symbols are used in these instructions.



#### **DANGER!**

##### **Warns of an immediate danger!**

- ▶ Failure to observe the warning may result in a fatal or serious injury.



#### **WARNING!**

##### **Warns of a potentially dangerous situation!**

- ▶ Failure to observe the warning may result in serious injuries or death.



#### **CAUTION!**

##### **Warns of a possible danger!**

- ▶ Failure to observe this warning may result in a moderately severe or minor injury.

#### **NOTE!**

##### **Warns of damage to property!**



Important tips and recommendations.



Refers to information in these operating instructions or in other documentation.

- ▶ Designates an instruction which you must follow to prevent a hazard.

→ designates a procedure which you must carry out.

## 2 INTENDED USE

**Non-intended use of the AirLINE Type 8640 may be a hazard to people, nearby equipment and the environment.**

- ▶ The device may be used for the control of pneumatically operated units.
- ▶ Do not use the device outdoors unprotected.
- ▶ Do not physically stress the housing (e.g. by placing objects on it or standing on it).
- ▶ Use according to the authorized data, service and operating conditions specified in the contract documents and operating instructions. These are described in the chapter entitled "[6 Technical data](#)".
- ▶ The device may be used only in conjunction with third-party devices and components recommended and authorized by Bürkert.
- ▶ Correct transportation, storage, and installation, as well as careful use and maintenance are essential for reliable and faultless operation.
- ▶ Do not supply the medium connectors of the system with aggressive or flammable media.
- ▶ Use the device only as intended.

### 2.1 Restrictions

If exporting the system/device, observe any existing restrictions.

## 3 GENERAL SAFETY INFORMATION

This safety information does not cover:

- Haphazard situations that can arise during installation, operation and maintenance of the use.
- Locally applicable safety regulations which the operator and installation personnel are obligated to follow.

### General Hazardous Situations.

To prevent injuries:

- ▶ Ensure that the system cannot be activated unintentionally.
- ▶ Note that pipes and valves must not become detached in systems which are under pressure.
- ▶ Before reaching into the system, always switch off the power supply.
- ▶ Design the pressure supply with the largest possible volume to prevent a pressure drop when the system is switched on.
- ▶ Installation and maintenance work may be carried out only by authorized technicians with the appropriate tools.
- ▶ After an interruption in the power supply or pneumatic supply, ensure that the process is restarted in a defined or controlled manner.
- ▶ The device may be operated only when in perfect condition and in consideration of the operating instructions.
- ▶ The general rules of technology must be observed for application planning and operation of the device.

**Risk of burns/risk of fire if used continuously through hot device surface!**

- ▶ Keep the device away from highly flammable substances and media and do not touch with bare hands.

**NOTE!**

**Electrostatic sensitive components/modules!**

The device contains electronic components, which react sensitively to electrostatic discharge (ESD). Contact with electrostatically charged persons or objects is hazardous to these components. In the worst case scenario, they will be destroyed immediately or will fail after start-up.

- ▶ Observe the requirements in accordance with EN 61340-5-1 and 5-2 to minimize/avoid the possibility of damage caused by a sudden electrostatic discharge!
- ▶ Also, ensure that you do not touch electronic components when the power supply voltage is present!

## 4 GENERAL INFORMATION

### 4.1 Contact address

**Germany** Bürkert Fluid Control Systems  
Sales Center  
Christian-Bürkert-Str. 13-17  
D-74653 Ingelfingen  
Tel. + 49 (0) 7940 - 10 91 111  
Fax + 49 (0) 7940 - 10 91 448  
E-mail: info@burkert.com

### International

Contact addresses are found on the final pages of this operating manual. And also on the Internet under: [www.burkert.com](http://www.burkert.com)

### 4.2 Warranty

The warranty is only valid if the AirLINE Type 8640 is used as intended in accordance with the specified application conditions.

### 4.3 Informations in the Internet

The operating manual and the data sheets on Type 8640 can be found on the Internet under: [www.burkert.com](http://www.burkert.com)

## 5 DEVICE REVISION

The hardware and firmware for the device have been revised. The revised version REV.2 is largely compatible with the previous version. Differences to be taken into account for the user relate to the EthernetIP and ModbusTCP Ethernet variants. The details are described in the operating instructions.



The operating instructions can be found on the Internet at: [www.burkert.com](http://www.burkert.com)

## 6 TECHNICAL DATA

### 6.1 Conformity

The AirLINE system Type 8640 conforms with the EC Directives according to the EC Declaration of Conformity.

### 6.2 Standards

The applied standards, which verify conformity with the EC Directives, can be found on the EC-Type Examination Certificate and / or the EC Declaration of Conformity.

### 6.3 General Technical Data

Technical Data	Pilot valve type 0460, 6524, 6525	Pilot valve type 0461, 6526, 6527
Pressure range	Vac. up to 10 bar	Vac. up to 10 bar
Operating voltage	24 V DC	24 V DC
Voltage tolerance	± 10 %	± 10 %
Ambient temperature	0 ... +55 °C (when using Type 0460 and 0461: 0 ... +50 °C)	

#### 6.3.1 Rating plate

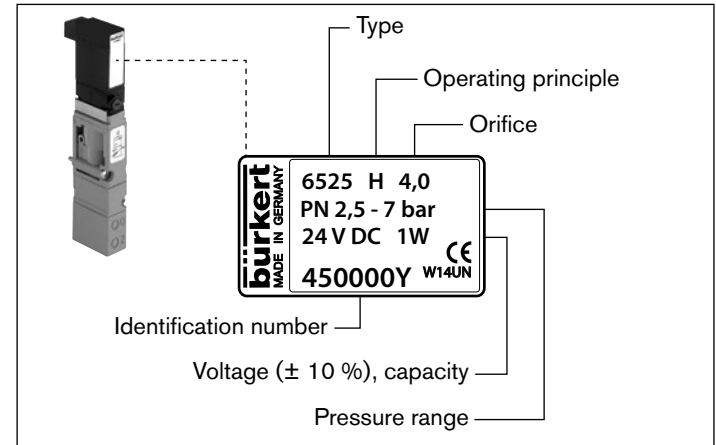

Fig. 1: Location and description of the rating plate

### 6.3.2 Fluid connection

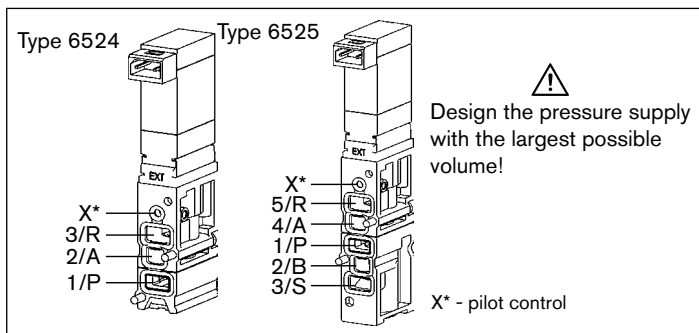

Fig. 2: Fluid connection. Types 6524 and 6525

### 6.3.3 Fluid and electrical connection

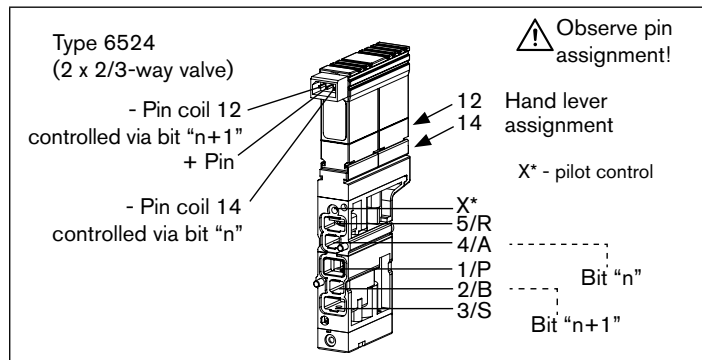

Fig. 3: Fluid and electrical connection. Type 6524

## 7 ASSEMBLY

### 7.1 Safety instructions



#### DANGER!

#### Risk of injury from high pressure in the equipment!

- ▶ Before loosening lines or valves, turn off the pressure and vent the lines.

#### Risk of injury due to electrical shock!

- ▶ Before reaching into the device or the equipment, switch off the power supply and secure to prevent reactivation!
- ▶ Observe applicable accident prevention and safety regulations for electrical equipment!



#### WARNING!

#### Risk of injury from improper assembly!

- ▶ Installation may only be carried out by authorized technicians with the appropriate tools!

#### Risk of injury from unintentional activation of the system and uncontrolled restart!

- ▶ Secure system from unintentional activation.
- ▶ Following assembly, ensure a controlled restart.



**⚠ CAUTION!**

**Escape of medium and malfunction!**

If the seals are not seated correctly, leaks and malfunctions may occur due to pressure losses.

- ▶ Ensure that the seals are seated correctly in the area of the electronics and pneumatics.

**Short-circuit, malfunction!**

The electrical connection requires exact contacting.

- ▶ Do not bend contacts.
- ▶ If connections are damaged or bent, replace the affected components.
- ▶ Do not switch on the system unless the components are in perfect condition.

**NOTE!**

**Operate the system with direct current only!**

To prevent damage to the system, use only direct current for the system power supply.

**Prevent a pressure drop!**

To prevent a pressure drop, design the system pressure supply with the largest possible volume.

## 7.2 Assembly

**⚠ DANGER!**

**Danger of explosion!**

If systems in the explosion-protected area are installed in a control cabinet, the following requirements must be met:

- ▶ The control cabinet must be authorized for use in the explosion-protected area.
- ▶ The control cabinet must be large enough to allow the resulting lost heat to be dissipated in a suitable manner to the outside.
- ▶ The internal temperature of the control cabinet must not exceed the max. permitted ambient temperature for the device.

**Risk of electric shock!**

- ▶ Before reaching into the device or the equipment, switch off the power supply and secure to prevent reactivation!

### 7.2.1 Installation on standard rail

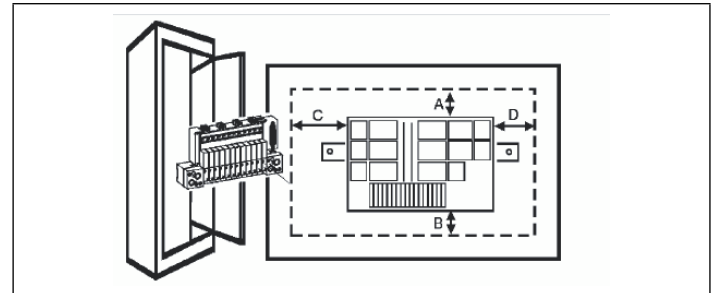

Fig. 4: Installation of a valve block into a control cabinet

- Fasten the standard rail firmly in the control cabinet.
- Establish a short, wide PE connection between the standard rail and the control cabinet.

**!** The valve terminal must be freely accessible from above. Ensure good heat dissipation!

**Recommended distance when installing in a control cabinet:**

<b>A</b>	30 mm	<b>C</b>	30 mm
<b>B</b>	30 mm	<b>D</b>	60 mm

**7.2.2 Installation of AirLINE Quick**

To install AirLINE Quick, a notch must be first of all provided on the base or the wall of the control cabinet, e.g. through lasing or punching. For the dimensions of the relevant flange image, refer to chapter [“7.2.3 Dimensions of the flange images for AirLINE Quick”](#).

The distances to the left, right, front and top depend on the selected valve terminal configuration.

**Recommended distance in the control cabinet to the valve terminal:**

left	right	front	top
30 mm	60 mm	30 mm	50 mm

**NOTE!**

**The opening on the control cabinet must be burr-free to prevent damage to the seal of the AirLINE Quick adapter.**

- Without damaging the seal of the AirLINE Quick adapter, insert it into the groove of the flange opening.

- Position the valve terminal in the control cabinet on the prepared opening.
- From outside attach the stability plate to prevent distortion and secure with screws M 5 x 10 from the enclosed fastening set.

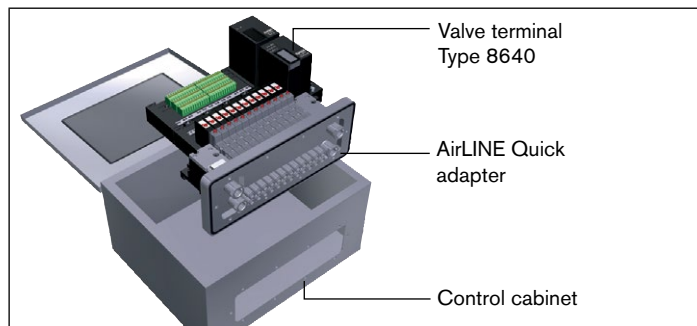

Fig. 5: Placing the valve terminal in the control cabinet

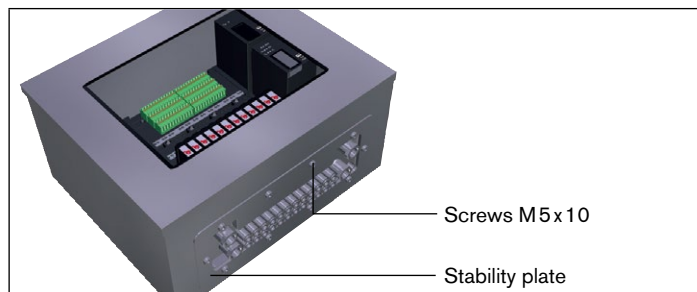

Fig. 6: Attaching the stability plate

### 7.2.3 Dimensions of the flange images for AirLINE Quick

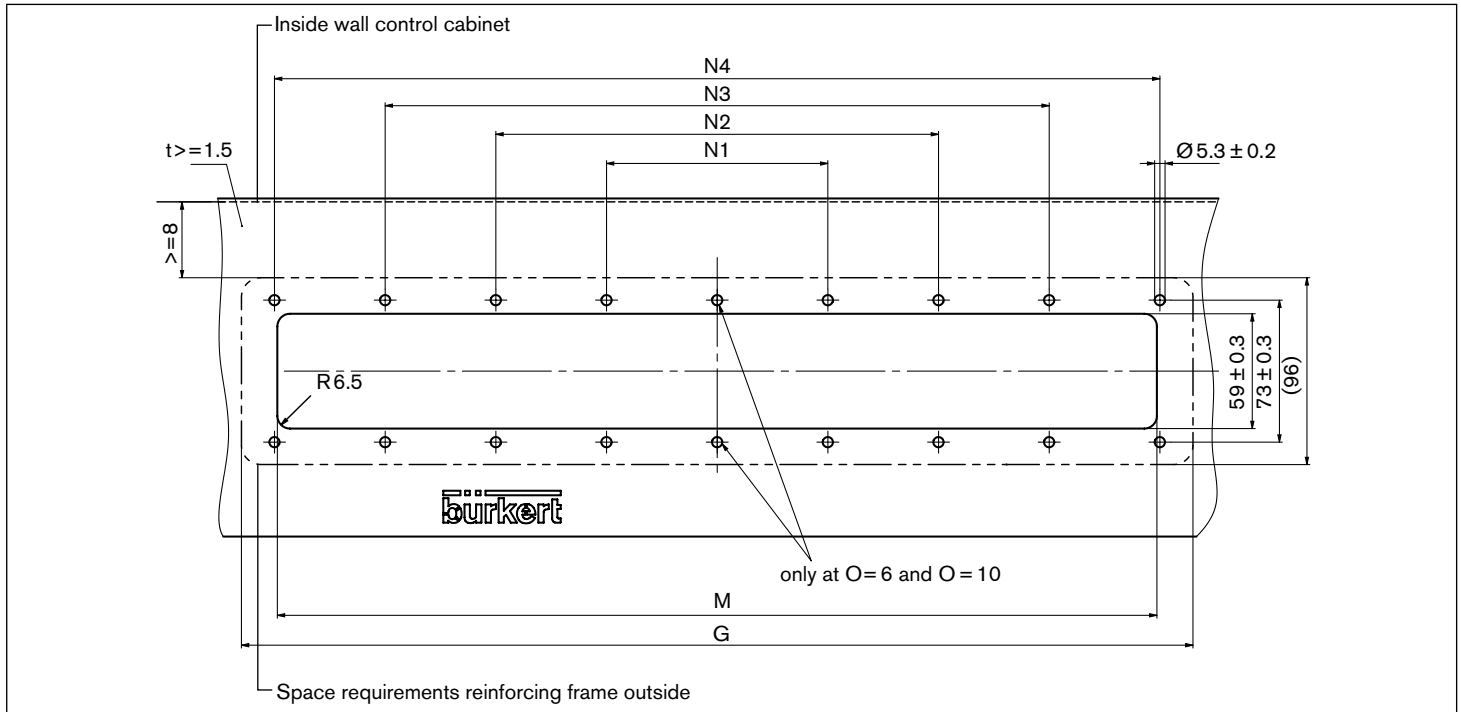

Fig. 7: Dimensions of the flange images for AirLINE Quick – for dimensions see “Tab. 1”, page 12

Feature	Version				
	4-fold	8-fold	12-fold	16-fold	24-fold
<b>M</b>	111 ±0.4	155 ±0.4	199 ±0.4	243 ±0.4	331 ±0.4
<b>N1</b>	114 ±0.4	54 ±0.3	68 ±0.3	123 ±0.4	66 ±0.3
<b>N2</b>	–	158 ±0.4	202 ±0.4	246 ±0.4	200 ±0.4
<b>N3</b>	–	–	–	–	334 ±0.4
<b>N4</b>	–	–	–	–	–
<b>O</b> (Number of bores)	6	8	8	10	12
<b>G</b>	148	192	236	280	368

Tab. 1: Dimensions of the flange images for AirLINE Quick.

## 8 INSTALLATION

### 8.1 Fluid Installation



#### **DANGER!**

#### **Risk of injury from high pressure in the equipment!**

- ▶ Before loosening lines or valves, turn off the pressure and vent the lines.
- ▶ Design the connections with the largest possible volume.
- ▶ Close the open connections not required with lock screws.
- ▶ The connections for the pilot control exhaust air (x) must not be sealed.
- ▶ Check correct assignment of the connections 1 and 3 or 5. They may by no means be interchanged.

#### 8.1.1 Pneumatic connections - feed

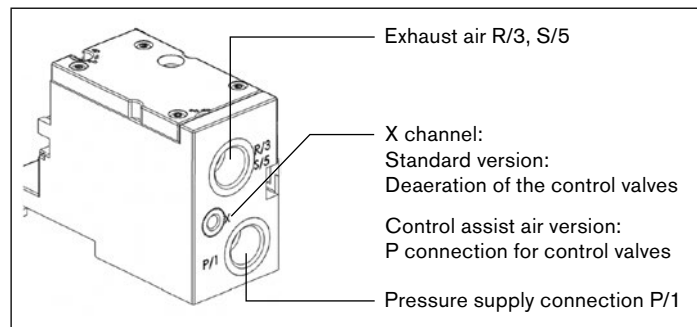

Fig. 8: Pneumatic connections

#### Procedure:

→ Depending on the version, plug the connections in the corresponding working connections or screw them in.

#### NOTE!

For the plug-in connections the hose pipes must meet the following requirements:

- ▶ Minimum hardness of 40 Shore D (in accordance with DIN 53505 or ISO 868);
- ▶ Outer diameter in accordance with DIN 73378 (max. permitted deviation  $\pm 0.1$  mm of the nominal dimension);
- ▶ Burr-free, cut off at right angles and undamaged on the outer diameter;

The hose pipes must be pressed all the way into the plug-in connections.

### 8.1.2 Removing the plug-in connections

→ To detach the pipes, press in the thrust ring and pull out the hose pipe.

### 8.1.3 Pneumatic connections - AirLINE standard

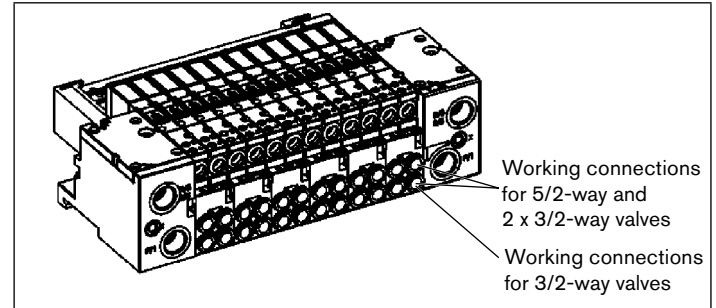

Fig. 9: Pneumatic connections - valve discs

#### Procedure:

- Depending on the version, plug the connections in the corresponding working connections (D6, D1/4) or screw them in (M7).
- Connection nipples can be used for threaded versions.

#### Inscription of the connections:

- Label the inscription areas with the data of the valve connections.

### 8.1.4 Pneumatic connections - AirLINE Quick

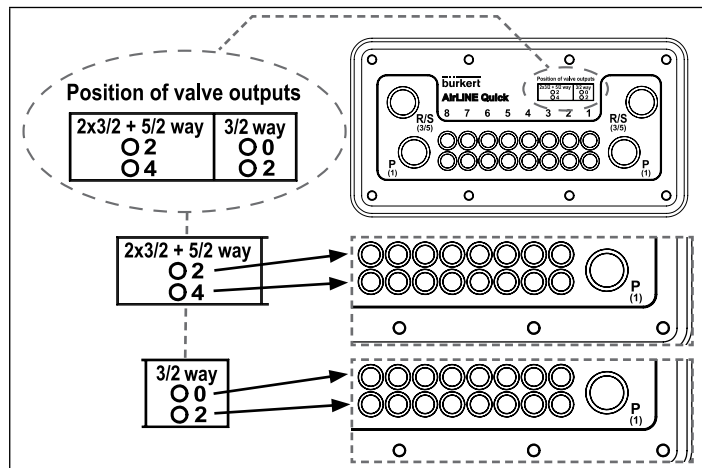

Fig. 10: Pneumatic connections – AirLINE Quick

**Procedure:**

→ Depending on the version, plug the connections in the corresponding working connections.

### 8.1.5 Fluid connection AirLINE Quick

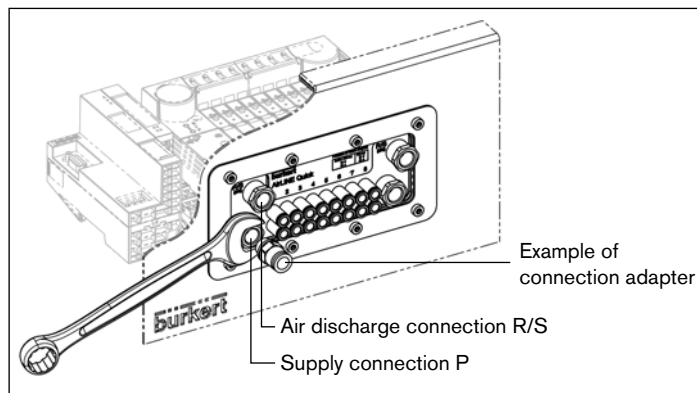

Fig. 11: Fluid connection AirLINE Quick

**Procedure:**

→ Screw connection adapter G1/4" or NPT 1/4" to connections P and R/S.

**NOTE!**

**Risk of leakage if screw connection is too tight!**

- ▶ When fitting the fluid connection adapters to the connections P, R/S, observe the max. torque of 12 Nm. In doing so, counter with a suitable tool to prevent the connections from turning!

## 8.2 Fluid deinstallation

### NOTE!

**Irreversible damage to the seal in the thread of the screw connection!**

- ▶ When loosening the connection adapters, use a suitable tool to prevent the corresponding supply or air discharge connection from turning.

## 8.3 Electrical Installation



### DANGER!

**Risk of injury due to electrical shock!**

- ▶ Before reaching into the device or the equipment, switch off the power supply and secure to prevent reactivation!

### 8.3.1 Conventional connection technology (multipole and multiple connection)

Module	Configuration	
Multiple connection	–	Ground
		Functional earth
Multi-pole connection for valve outputs		Pin 1      Valve 1
		⋮            ⋮
		Pin 24 <sup>1)</sup> Valve 24
		Pin 25      Ground
Multipole circuit feedback indicator inputs		Pin 1      Input 1
		⋮            ⋮
		Pin 32      Input 32
		Pin 43      24 V
		Pin 44      Ground

<sup>1)</sup> In manual/automatic mode Pin 24 is constantly supplied with 24 V.

### 8.3.2 Field bus technology connections

Please observe section "5 Device revision", page 6.

Pin	Profibus DP		CanOpen / DeviceNet		Profinet, Ethernet/ IP, Modbus TCP
	IP20	IP54	IP20	IP54	
1	n. c.	+5 V	n. c.	Drain	TX+
2	n. c.	RxD/TxD-N/A-line	CAN LOW	n. c.	TX-
3	RxD/TxD-P/B-line	DGND	GND	GND	RX+
4	CNTR-P (RTS)	RxD/TxD-P/B-line	n. c.	CAN HIGH	n. c.
5	DGND	Shield	n. c.	CAN LOW	n. c.
6	+5 V		n. c.		RX-
7	n. c.		CAN HIGH		n. c.
8	RxD/TxD-N/A-line		n. c.		n. c.
9	n. c.		n. c.		
	D-SUB 9	5-pole M12	D-SUB 9	5-pole	RJ45
	female	female (Reverse-Key)	male	Micro 12	female

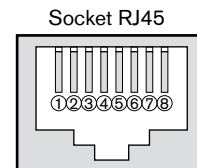
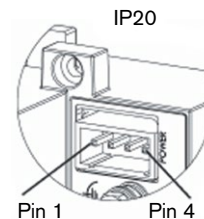
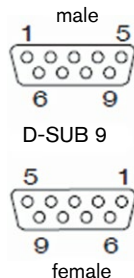

### 8.3.3 Power supply connections

Pin	All models	
	IP20	IP54
1	GND Outputs	24 V DC Outputs
2	24 V DC Outputs	24 V DC Logic
3	GND Logic	GND Logic
4	24 V DC Logic	GND Outputs



## Type 8640

Installation

### 8.3.4 DIP switch settings

#### Profibus-DP

1	2	3	4	5	6	7	8
Address of the profibus DP subscriber - 125							OFF

#### DeviceNet / CanOpen

1	2	3	4	5	6	7	8
Address of the field bus module 0 – 63						Baud rate	

#### Baud rate

DIP 7/8	DVN	COP
0	125 kB	20 kB
1	250 kB	125 kB
2	500 kB	250 kB
3	-	500 kB

### 8.3.5 RIO - internal bus extension

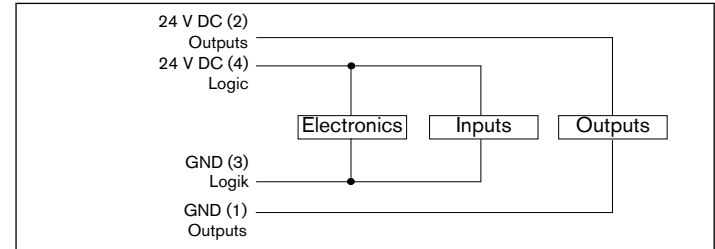
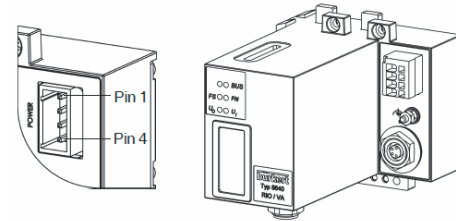

Fig. 12: Power supply



Internal field bus: 4-pole socket M8



Field bus settings:

#### DIP switches

1	2	3	4	5	6	7	8
Address on the internal RIO bus			Mode inputs		Reserve always OFF		Terminating resistors

### 8.3.6 Address on the internal RIO bus: DIP switches 1 to 3

Each peripheral terminal has a unique address. This address is set on the valve terminal via DIP switches 1 to 3.

DIP 1	DIP 2	DIP 3	Address	Peripheral terminal
OFF	OFF	OFF	0	0
ON	OFF	OFF	1	1
OFF	ON	OFF	2	2
<b>ON</b>	<b>ON</b>	<b>OFF</b>	<b>3</b>	<b>3</b>
OFF	OFF	ON	4	4
ON	OFF	ON	5	5
OFF	ON	ON	6	6
ON	ON	ON	7	7

### 8.3.7 Mode inputs: DIP switches 4 and 5 **NOTE!**

The input modes allow the entries (feedback indicator) to be assigned in different ways in the process image of the inputs (PAE).

	DIP 4	DIP 5
No entries available	OFF	OFF
Normal mode	ON	OFF
Mode: shifted inputs	OFF	ON
Mode: halved inputs	ON	ON



#### **CAUTION!**

If there are no inputs available, both switches must be set to OFF.

## 9 START-UP



### WARNING!

#### Risk of injury from improper operation!

Improper operation may result in injuries as well as damage to the device and the area around it.

- ▶ Before start-up, ensure that the operating personnel are familiar with and completely understand the contents of the operating instructions.
- ▶ Observe the safety instructions and intended use.
- ▶ Only adequately trained personnel may start up the equipment/ the device.

### NOTE!

- ▶ Switch on the supply pressure.
- ▶ Only then switch on the power supply!

#### Procedures before fluid start-up:

- Check connections, voltage and operating pressure.
- Ensure that max. operating data are not exceeded.
- Check correct assignment of the connections 1 and 3 or 5. They may by no means be interchanged.
- Release manual actuation during electrical operation.

## 10 MAINTENANCE

See ["8.2 Fluid deinstallation"](#), page 15.

## 11 TRANSPORT, STORAGE, DISPOSAL

### NOTE!

#### Transport damages!

Inadequately protected equipment may be damaged during transport.

- ▶ During transportation protect the device against wet and dirt in shock-resistant packaging.
- ▶ Avoid exceeding or dropping below the permitted storage temperature.

#### Incorrect storage may damage the device!

- ▶ Store the device in a dry and dust-free location!
- ▶ Storage temperature: -20 ... +60 °C.

#### Damage to the environment caused by device components contaminated with media!

- ▶ Ensure the device and packaging are disposed of in an environmentally sound manner.
- ▶ Observe applicable regulations relating to refuse disposal and the environment.
- ▶ Observe the national waste disposal regulations.



[www.burkert.com](http://www.burkert.com)