

## Type 8226

Inductive conductivity meter  
Induktiver Leitfähigkeits-Messgerät  
Conductivimètre inductif



## Operating Instructions

Bedienungsanleitung  
Manuel d'utilisation

We reserve the right to make technical changes without notice.  
Technische Änderungen vorbehalten.  
Sous réserve de modifications techniques.

© 2012 Bürkert SAS

Operating Instructions 1208/0\_EU-ML\_00428979\_Original\_FR

|           |   |           |
|-----------|---|-----------|
| <b>1.</b> | <b>ABOUT THIS MANUAL .....</b>  | <b>4</b>  |
| 1.1.      | Symbols used .....  | 4         |
| 1.2.      | Definition of the word "device" .....                                 | 4         |
| <b>2.</b> | <b>INTENDED USE .....</b>   | <b>5</b>  |
| <b>3.</b> | <b>BASIC SAFETY INFORMATION .....</b>                                 | <b>6</b>  |
| <b>4.</b> | <b>GENERAL INFORMATION .....</b>                                      | <b>8</b>  |
| 4.1.      | Manufacturer's address and international contacts .....               | 8         |
| 4.2.      | Warranty conditions .....   | 8         |
| 4.3.      | Information on the Internet .....                                     | 8         |
| <b>5.</b> | <b>DESCRIPTION .....</b>  | <b>9</b>  |
| 5.1.      | Area of application .....   | 9         |
| 5.2.      | General description .....   | 9         |
| 5.2.1.    | Construction .....  | 9         |
| 5.2.2.    | Conductivity sensor .....   | 9         |
| 5.3.      | Description of the name plate .....                                   | 10        |
| 5.4.      | Available versions .....  | 10        |
| <b>6.</b> | <b>TECHNICAL DATA .....</b>   | <b>11</b> |
| 6.1.      | Conditions of use .....   | 11        |
| 6.2.      | Conformity to standards and directives .....                          | 11        |
| 6.3.      | General technical data .....  | 11        |
| 6.3.1.    | Mechanical data .....   | 11        |
| 6.3.2.    | General data .....  | 12        |
| 6.3.3.    | Electrical data .....   | 13        |
| 6.3.4.    | Data of the cables and wires .....                                    | 14        |
| <b>7.</b> | <b>INSTALLATION AND WIRING .....</b>                                  | <b>15</b> |
| 7.1.      | Safety instructions .....   | 15        |
| 7.2.      | Fluid pressure and temperature dependency .....                       | 16        |
| 7.3.      | Installation onto the pipe .....                                      | 16        |
| 7.4.      | Wiring .....  | 18        |
| 7.4.1.    | Wiring a 12-30 V DC version with a male EN 175301-803 connector ..... | 18        |

|             |  |           |
|-------------|--|-----------|
| 7.4.2.      | Wiring of a 12-30 V DC version with cable glands and no relays .....                         | 19        |
| 7.4.3.      | Wiring of a 12-30 V DC version with cable glands and relays .....                            | 20        |
| 7.4.4.      | Wiring of a 115/230 V AC version .....   | 21        |
| <b>8.</b>   | <b>OPERATING AND COMMISSIONING .....</b>   | <b>23</b> |
| <b>8.1.</b> | <b>Safety instructions .....</b>   | <b>23</b> |
| <b>8.2.</b> | <b>Operating levels.....</b>   | <b>23</b> |
| <b>8.3.</b> | <b>Using the navigation keys.....</b>  | <b>25</b> |
| <b>8.4.</b> | <b>Description of the display .....</b>  | <b>25</b> |
| <b>8.5.</b> | <b>Details of the Process level .....</b>  | <b>26</b> |
| <b>8.6.</b> | <b>HOLD mode .....</b>   | <b>26</b> |
| <b>8.7.</b> | <b>Parameters menu .....</b>   | <b>27</b> |
| 8.7.1.      | Choosing the display language.....   | 27        |
| 8.7.2.      | Choosing units of conductivity and temperature .....   | 28        |
| 8.7.3.      | Adjusting the coefficient of the sensor with relation to the process .....                   | 28        |
| 8.7.4.      | Adjusting the coefficient of the sensor after a certain period of use.....                   | 29        |
| 8.7.5.      | Adjusting the temperature compensation coefficient .....                                     | 30        |
| 8.7.6.      | Configuring the current output.....  | 34        |
| 8.7.7.      | Setting the switching thresholds of the relays (if the device is equipped with relays) ..... | 35        |
| 8.7.8.      | Choosing a damping effect to prevent fluctuations .....                                      | 37        |
| <b>8.8.</b> | <b>Test menu .....</b>   | <b>38</b> |
| 8.8.1.      | Adjusting the "OFFSET" for the output current.....   | 38        |
| 8.8.2.      | Adjusting the "SPAN" for the output current .....  | 39        |
| 8.8.3.      | Adjusting the temperature.....   | 39        |
| 8.8.4.      | Reading non-compensated conductivity .....   | 39        |
| 8.8.5.      | Testing off-fluid the settings of the current output and the relays .....                    | 40        |
| 8.8.6.      | Setting the zero point of conductivity .....   | 41        |
| <b>8.9.</b> | <b>Default settings of the device .....</b>  | <b>41</b> |
| <b>9.</b>   | <b>MAINTENANCE AND TROUBLESHOOTING.....</b>  | <b>42</b> |
| <b>9.1.</b> | <b>Safety instructions .....</b>   | <b>42</b> |
| <b>9.2.</b> | <b>Cleaning the device .....</b>   | <b>42</b> |
| <b>9.3.</b> | <b>If you encounter problems .....</b>   | <b>43</b> |

|     |                                  |    |
|-----|----------------------------------|----|
| 10. | SPARE PARTS AND ACCESSORIES..... | 45 |
| 11. | PACKAGING, TRANSPORT.....        | 47 |
| 12. | STORAGE.....                     | 47 |
| 13. | DISPOSAL OF THE PRODUCT.....     | 47 |

# 1. ABOUT THIS MANUAL

This manual describes the entire life cycle of the device. Please keep this manual in a safe place, accessible to all users and any new owners.

**This manual contains important safety information.**

- Failure to comply with these instructions can lead to hazardous situations.
- This manual must be read and understood.

## 1.1. Symbols used



### **DANGER**

**Warns against an imminent danger.**

- Failure to observe this warning can result in death or in serious injury.



### **WARNING**

**Warns against a potentially dangerous situation.**

- Failure to observe this warning can result in serious injury or even death.



### **ATTENTION**

**Warns against a possible risk.**

- Failure to observe this warning can result in substantial or minor injuries.

### **NOTE**

**Warns against material damage.**

- Failure to observe this warning may result in damage to the device or system.



Indicates additional information, advice or important recommendations.



Refers to information contained in this manual or in other documents.

→ Indicates a procedure to be carried out.

## 1.2. Definition of the word "device"

The word "device" used within this manual refers to the conductivity meter type 8226.

## 2. INTENDED USE

**Use of the device that does not comply with the instructions could present risks to people, nearby installations and the environment.**

- The device is intended to measure the conductivity.
- This device must be protected against electromagnetic interference, ultraviolet rays and, when installed outdoors, the effects of climatic conditions.
- This device must be used in compliance with the characteristics and commissioning and use conditions specified in the contractual documents and in the user manual.
- Requirements for the safe and proper operation of the device are proper transport, storage and installation, as well as careful operation and maintenance.
- Only use the device as intended.

→ Observe any existing restraints when the device is exported.

### 3. BASIC SAFETY INFORMATION

This safety information does not take into account:

- any contingencies or occurrences that may arise during installation, use and maintenance of the devices.
- the local safety regulations for which the operating company is responsible including the staff in charge of installation and maintenance.



#### **Danger due to high pressure in the installation.**

- Stop the circulation of fluid, cut off the pressure and drain the pipe before loosening the process connections.

#### **Danger due to electrical voltage.**

- Shut down and isolate the electrical power source before carrying out work on the system.
- Observe all applicable accident protection and safety regulations for electrical equipment.

#### **Danger due to high fluid temperatures.**

- Use safety gloves to handle the device.
- Stop the circulation of fluid and drain the pipes before loosening the process connections.
- Keep all easily flammable material and fluid away from the device.

#### **Danger due to the nature of the fluid.**

- Respect the prevailing rules on accident prevention and safety relating to the use of aggressive fluids.



#### **Various dangerous situations**

To avoid injury take care:

- to prevent any unintentional power supply switch-on.
- to ensure that installation and maintenance work are carried out by qualified, authorised personnel in possession of the appropriate tools.
- to guarantee a defined or controlled restarting of the process, after a power supply interruption.
- to use the device only if in perfect working order and in compliance with the instructions provided in the instruction manual.
- to observe the general technical rules when installing and using the device.
- not to use the device in explosive atmospheres.
- not to use the device in an environment incompatible with the materials it is made of.
- not to use fluid that is incompatible with the materials the device is made of.
- not to subject the device to mechanical loads (e.g. by placing objects on top of it or by using it as a step).
- not to make any external modifications to the device. Do not paint or varnish any part of the device.



## NOTE

### The device may be damaged by the fluid in contact with.

- Systematically check the chemical compatibility of the component materials of the device and the fluids likely to come into contact with it (for example: alcohols, strong or concentrated acids, aldehydes, alkaline compounds, esters, aliphatic compounds, ketones, halogenated aromatics or hydrocarbons, oxidants and chlorinated agents).

## NOTE

### Elements / Components sensitive to electrostatic discharges

- This device contains electronic components sensitive to electrostatic discharges. They may be damaged if they are touched by an electrostatically charged person or object. In the worst case scenario, these components are instantly destroyed or go out of order as soon as they are activated.
- To minimise or even avoid all damage due to an electrostatic discharge, take all the precautions described in the EN 61340-5-1 and 5-2 norms.
- Also ensure that you do not touch any of the live electrical components.

## **4. GENERAL INFORMATION**

### **4.1. Manufacturer's address and international contacts**

To contact the manufacturer of the device, use following address:

Bürkert SAS

Rue du Giessen

BP 21

F-67220 TRIEMBACH-AU-VAL

You may also contact your local Bürkert sales office.

The addresses of our international sales offices are available on the internet at: [www.burkert.com](http://www.burkert.com)

### **4.2. Warranty conditions**

The condition governing the legal warranty is the conforming use of the 8226 in observance of the operating conditions specified in this manual.

### **4.3. Information on the Internet**

You can find the user manuals and technical data sheets regarding the type 8226 at: [www.burkert.com](http://www.burkert.com)

## 5. DESCRIPTION

### 5.1. Area of application

The 8226 conductivity meter is intended solely for the measurement of the conductivity. Thanks to a fully configurable 4-20 mA current output, the device can be used to establish a regulation loop, and thanks to 2 fully configurable relay outputs (if available on the version used), it allows commutation of a solenoid valve, a pump or activation of an alarm.

### 5.2. General description

#### 5.2.1. Construction

The 8226 conductivity meter comprises:

- an electronic module with a built-in display module,
- a conductivity sensor comprised of:
  - a pair of magnetic coils,
  - a PP, PVDF or PEEK holder with a built-in temperature probe for the automatic compensation of the temperature.

Depending on the version:

- the device is energized with a 12-30 V DC or a 115/230 V AC power supply,
- the device is wired via an EN 175301-803 male fixed connector or with terminal blocks on the electronic board, via two cable glands.

#### 5.2.2. Conductivity sensor

The conductivity of a fluid is the capacity of this fluid to conduct electrical current thanks to the ions in the fluid.

The conductivity sensor measures the current intensity induced by the magnetic field, generated in the magnetic coil.

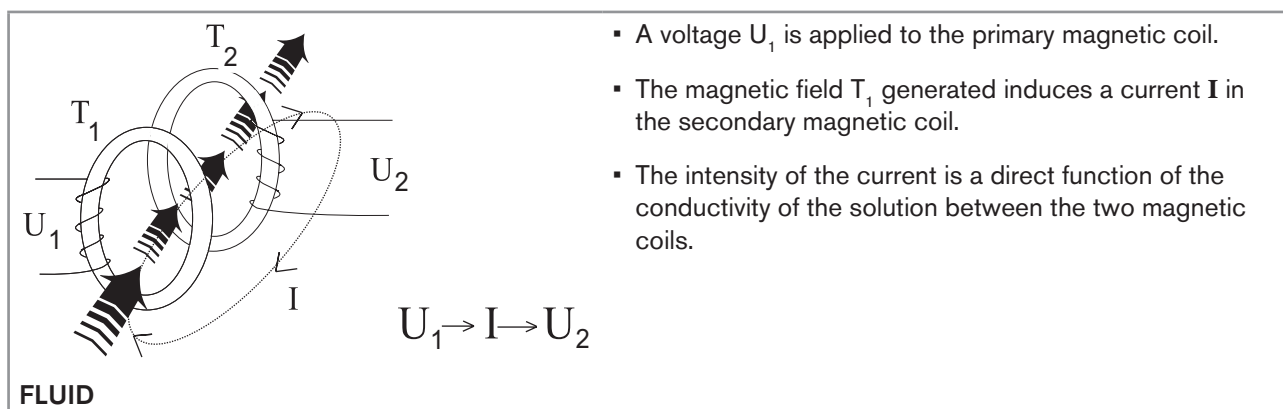


Figure 1 : Measuring principle

### 5.3. Description of the name plate

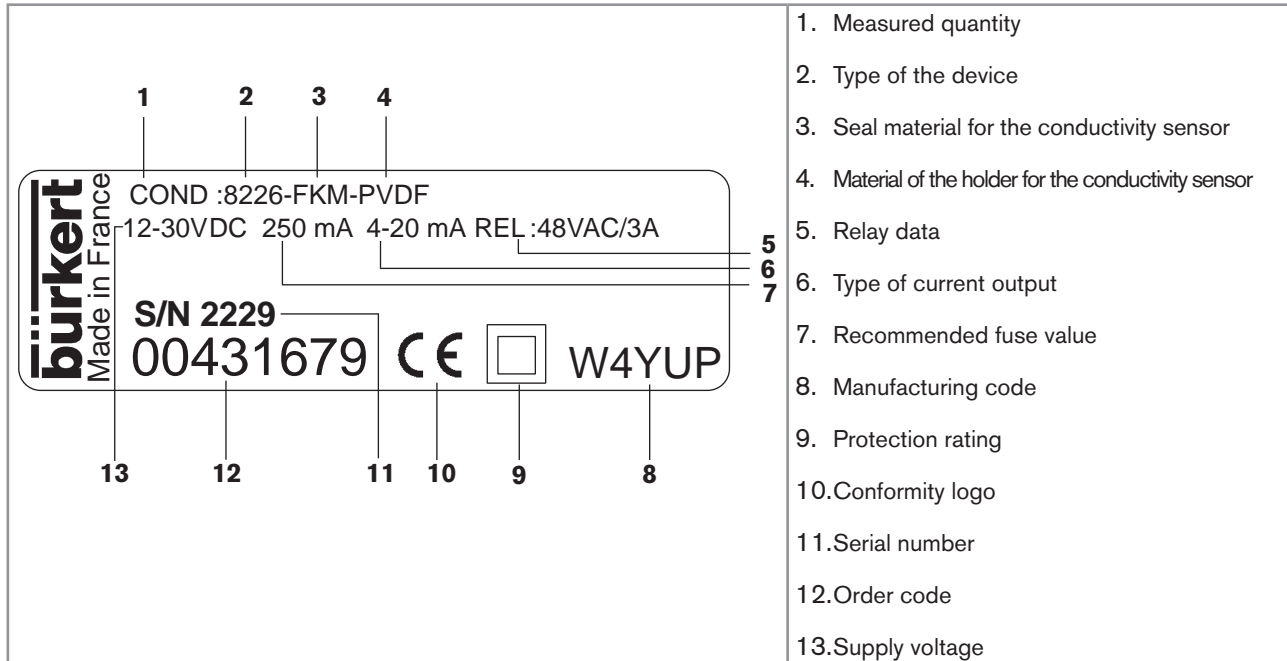


Figure 2 : Name plate of the 8226 conductivity meter

### 5.4. Available versions

| Supply voltage | Current output | Relay | Material                   |                     |                           | Electrical connection              | Order code         |                    |         |
|----------------|----------------|-------|----------------------------|---------------------|---------------------------|------------------------------------|--------------------|--------------------|---------|
|                |                |       | Conductivity sensor holder | Seal <sup>(1)</sup> | Housing, cover, nut / lid |                                    |                    |                    |         |
| 12-30 V DC     | 4-20 mA        | None  | PP                         | FKM                 | PC / PC                   | male fixed connector EN 175301-803 | 558 768            |                    |         |
|                |                |       |                            |                     |                           | via 2 cable glands                 | 558 769            |                    |         |
|                |                |       | PVDF                       | FKM                 | PC / PC                   | male fixed connector EN 175301-803 | 431 673            |                    |         |
|                |                |       |                            |                     |                           | via 2 cable glands                 | 431 674            |                    |         |
|                |                |       | PEEK                       | EPDM                | PPA / PSU                 | male fixed connector EN 175301-803 | 440 321            |                    |         |
|                |                |       |                            |                     |                           | via 2 cable glands                 | 440 322            |                    |         |
|                |                |       |                            | 2                   | PP                        | FKM                                | PC / PC            | via 2 cable glands | 558 770 |
|                |                |       |                            |                     |                           |                                    | via 2 cable glands | 431 679            |         |
|                |                |       |                            |                     |                           |                                    | via 2 cable glands | 440 324            |         |
|                |                |       |                            |                     |                           |                                    |                    |                    |         |
| 115/230 V AC   | 4-20 mA        | None  | PP                         | FKM                 | PC / PC                   | via 2 cable glands                 | 558 771            |                    |         |
|                |                |       | PVDF                       | FKM                 | PC / PC                   | via 2 cable glands                 | 431 677            |                    |         |
|                |                |       | PEEK                       | EPDM                | PPA / PSU                 | via 2 cable glands                 | 440 323            |                    |         |
|                |                | 2     | PP                         | FKM                 | PC / PC                   | via 2 cable glands                 | 558 772            |                    |         |
|                |                |       | PVDF                       | FKM                 | PC / PC                   | via 2 cable glands                 | 431 681            |                    |         |
|                |                |       | PEEK                       | EPDM                | PPA / PSU                 | via 2 cable glands                 | 440 325            |                    |         |

<sup>(1)</sup> 1 set with a black EPDM seal for the sensor, an obturator for an M20x1.5 cable gland, a 2x6 mm multiway seal and a mounting instruction sheet is supplied with each device.

## 6. TECHNICAL DATA

### 6.1. Conditions of use

|                     |   |
|---------------------|---|
| Ambient temperature | 0 to +60 °C   |
| Air humidity        | < 80%, non condensing   |
| Protection rating   | IP65 with a connector plugged-in and screwed, or the cable glands wired and tightened, or the cable glands sealed if not used |

### 6.2. Conformity to standards and directives

The device conforms to the EC directives through the following standards:

- EMC: EN 50081-2, EN 50082-2
- LVD: EN 61010-1
- Pressure: article 3§3 of the Pressure Directive 97/23/CE. Acc. to the Pressure Directive 97/23/CE: the device can only be used in the following cases (depending on the max. pressure, the DN of the pipe and the fluid)

| Type of fluid             | Conditions |
|---------------------------|------------|
| Fluid group 1, par. 1.3.a | Forbidden  |
| Fluid group 2 par. 1.3.a  | DN ≤ 100   |
| Fluid group 1 par. 1.3.b  | DN ≤ 100   |
| Fluid group 2 par. 1.3.b  | DN ≤ 100   |

### 6.3. General technical data

#### 6.3.1. Mechanical data

| Part   | Material         |
|--|------------------|
| Housing, nut:                                |                  |
| ▪ with PVDF or PP conductivity sensor holder | ▪ PC             |
| ▪ with PEEK conductivity sensor holder       | ▪ PPA            |
| Cover / seal:                                |                  |
| ▪ with PVDF or PP conductivity sensor holder | ▪ PC / NBR       |
| ▪ with PEEK conductivity sensor holder       | ▪ PPA / NBR      |
| Lid / seal:                                  |                  |
| ▪ with PVDF or PP conductivity sensor holder | ▪ PC / silicone  |
| ▪ with PEEK conductivity sensor holder       | ▪ PSU / silicone |
| Front foil                                   | polyester        |
| Male EN 175301-803 fixed connector           | tin              |
| Screws                                       | stainless steel  |

| Part                               | Material  |
|------------------------------------|---|
| Connector type 2508 / cable glands | PA  |
| Conductivity sensor holder / seal  | <ul style="list-style-type: none"> <li>▪ PVDF or PP / FKM</li> <li>▪ PEEK / EPDM</li> </ul> |

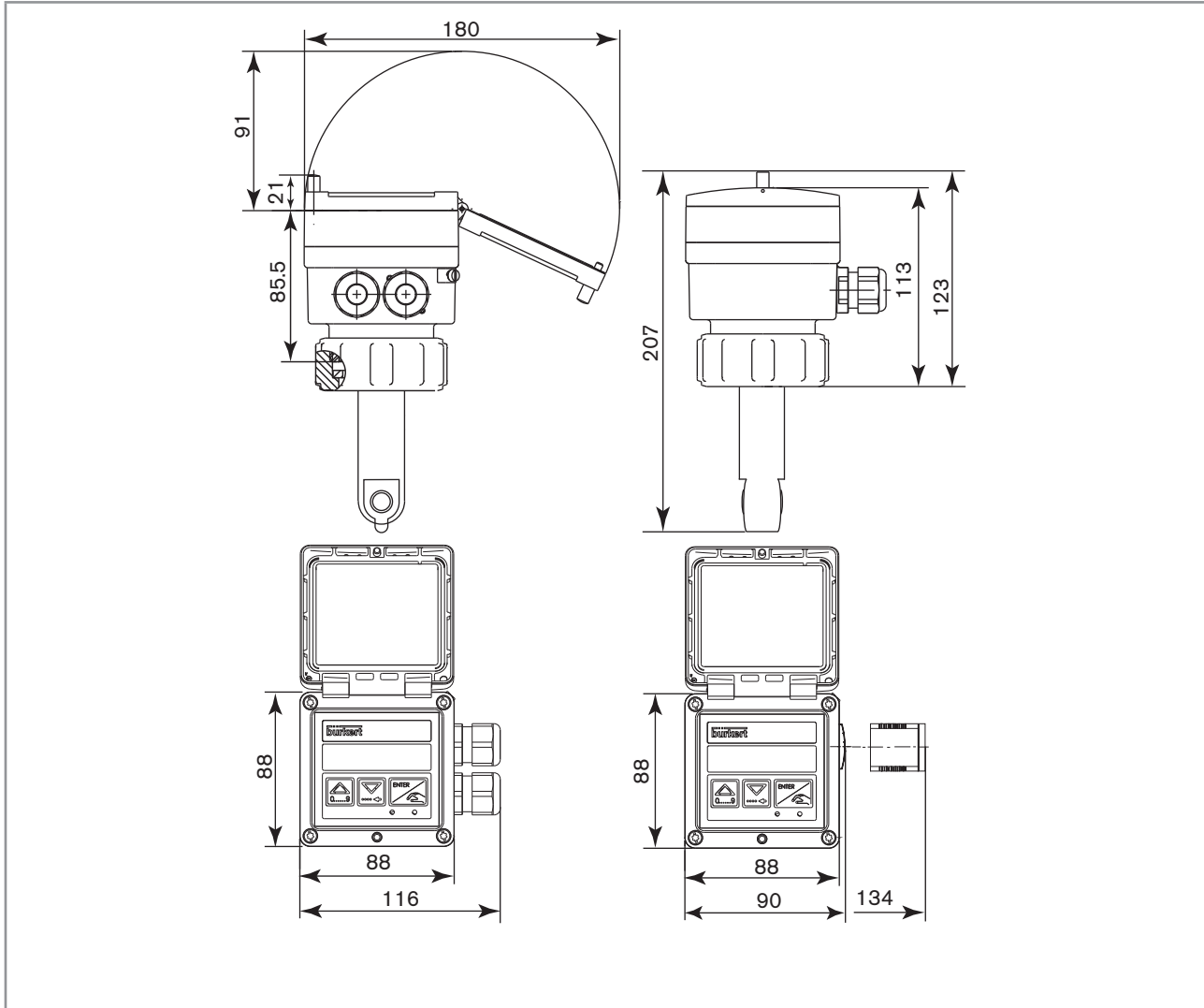


Figure 3 : Dimensions of the device [mm]

### 6.3.2. General data

|                                       |   |
|---------------------------------------|---|
| Pipe diameter                         | DN15 to DN200   |
| Type of fitting                       | S020: see related operating manual  |
| Nut holding the device on the fitting | G 2" internal thread  |
| Fluid temperature                     | depending on the version.<br>Pressure of the fluid and material of the fitting S020 used, can limit the fluid temperature (see Figure 4). |

|  |  |
|--|--|
| Fluid pressure   | PN6 at 25 °C.<br>Fluid temperature and material of the fitting S020 used, can limit the pressure of the fluid (see <a href="#">Figure 4</a> ). |
| <b>Conductivity measurement</b>                              |  |
| ▪ Measurement range  | ▪ 100 µS/cm to 2 S/cm  |
| ▪ Resolution   | ▪ internal=0.1 µS/cm; displayed=1 µS/cm  |
| ▪ Measuring error  | ▪ ±2% of the measured value  |
| Temperature probe  | digital, built-in the conductivity sensor  |
| <b>Temperature measurement</b>                               |  |
| ▪ Measurement range  | ▪ -15 °C to +120 °C  |
| ▪ Resolution   | ▪ 0.1 °C   |
| ▪ Measuring error  | ▪ ±0.5 °C from 0 °C to +100 °C<br>▪ ±1 °C from -15 °C to 0 °C and from +110 °C to +120 °C  |
| ▪ Min. temperature range corresponding to the 4-20 mA signal | ▪ 4 °C or 8 °F   |
| Temperature compensation                                     | automatic or linear (with a built-in temperature probe);<br>reference temperature 25 °C.   |

### 6.3.3. Electrical data

|                                     |   |
|-------------------------------------|---|
| Power supply                        | ▪ 12-30 V DC ±5 %, filtered and regulated<br>▪ 115/230 V AC               |
| <b>Current consumption</b>          |   |
| ▪ 12-30 V DC version with relays    | ▪ 150 mA at 12 V DC and 90 mA at 24 V DC                                  |
| ▪ 12-30 V DC version without relays | ▪ 70 mA at 12 V DC and 60 mA at 24 V DC                                   |
| ▪ 115/230 V AC version              | ▪ 150 mA  |
| <b>Current output</b>               | 4-20 mA, configurable, function of the conductivity or temperature        |
| ▪ Accuracy                          | ▪ ±1 %  |
| ▪ Connection type                   | ▪ 3-wire  |
| ▪ Loop impedance                    | ▪ 1000 Ω at 30 V DC; 800 Ω at 24 V DC; 450 Ω at 15 V DC; 330 Ω at 12 V DC |
| <b>Relay output</b>                 | off-position normally open  |
| ▪ Load                              | ▪ 3 A, 250 V AC   |
| ▪ Life span                         | ▪ 100 000 cycles (minimum)  |
| ▪ Operating                         | ▪ hysteresis with adjustable thresholds                                   |

MAN 1000189134 EN Version: A Status: RL (released | freigegeben) printed: 22.09.2017

### 6.3.4. Data of the cables and wires

| Version                                 | Wiring type   | Cable diameter  | Cross section of the wires   |
|---|---|---|--|
| with male EN 175301-803 fixed connector | <ul style="list-style-type: none"> <li>▪ female connector type 2508 (supplied)</li> <li>▪ or female connector type 2509, available as an accessory</li> </ul> | 5 to 8 mm   | 0.25 to 1.5 mm <sup>2</sup>  |
| with 2 cable glands                     | shielded cable  | <ul style="list-style-type: none"> <li>▪ 4 to 8 mm if 2 cables per cable gland, using a multiway seal.</li> <li>▪ 6 to 12 mm if 1 cable per cable gland.</li> </ul> | <ul style="list-style-type: none"> <li>▪ single- or multiple conductor: max. 2.5 mm<sup>2</sup></li> <li>▪ with wire end ferrule: max. 1.5 mm<sup>2</sup></li> </ul> |



## 7. INSTALLATION AND WIRING

### 7.1. Safety instructions



#### **DANGER**

##### **Risk of injury due to high pressure in the installation.**

- Stop the circulation of fluid, cut off the pressure and drain the pipe before loosening the process connections.

##### **Risk of injury due to electrical voltage.**

- Shut down and isolate the electrical power source before carrying out work on the system.
- Observe all applicable accident protection and safety regulations for electrical equipment.

##### **Danger due to high fluid temperatures.**

- Use safety gloves to handle the device.
- Stop the circulation of fluid and drain the pipes before loosening the process connections.
- Keep all easily flammable material and fluid away from the device.

##### **Risk of injury due to the nature of the fluid.**

- Respect the prevailing rules on accident prevention and safety relating to the use of aggressive fluids.



#### **WARNING**

##### **Risk of injury due to non-conforming installation.**

- The electrical and fluid installation can only be carried out by qualified and skilled staff with the appropriate tools.
- Install appropriate safety devices (correctly rated fuse and/or circuit-breaker).
- Respect the assembly instructions for the fitting used.

##### **Risk of injury due to unintentional switch on of power supply or uncontrolled restarting of the installation.**

- Take appropriate measures to avoid unintentional activation of the installation.
- Guarantee a set or controlled restarting of the process subsequent to any intervention on the device.



Comply with fluid temperature and pressure dependency with relation to the material of the fitting (see [Figure 4](#) hereafter).

## 7.2. Fluid pressure and temperature dependency

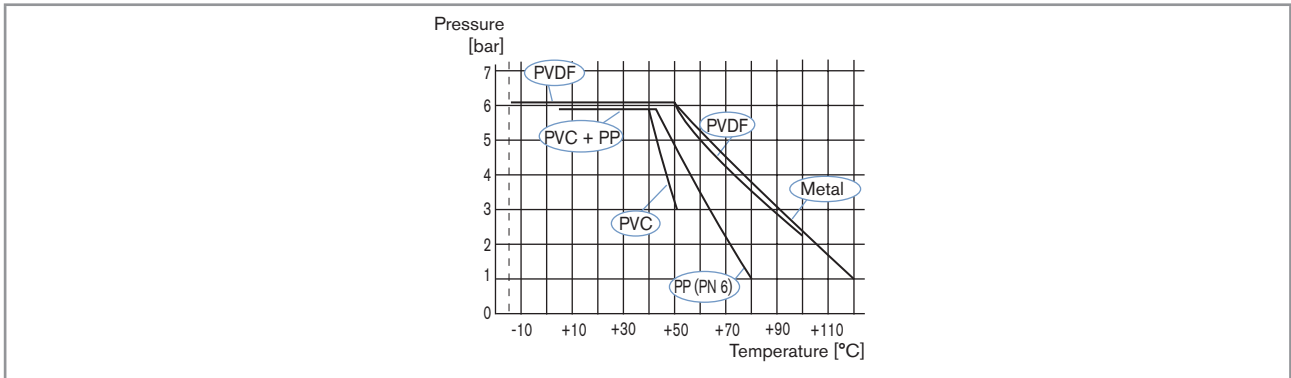


Figure 4 : Fluid pressure and temperature dependency with relation to the metal, PVC, PP or PVDF based S020 fitting

## 7.3. Installation onto the pipe

### DANGER


**Risk of injury due to high pressure in the installation.**

- Stop the circulation of fluid, cut off the pressure and drain the pipe before loosening the process connections.

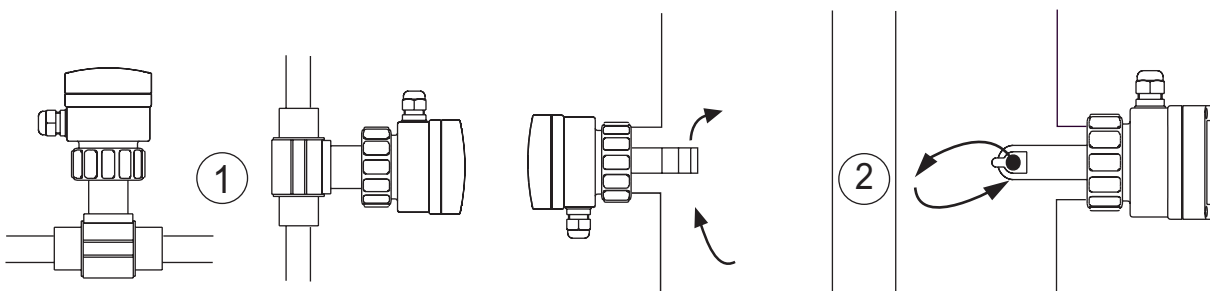
**Risk of injury due to the nature of the fluid.**

- Respect the prevailing rules on accident prevention and safety relating to the use of aggressive fluids.

The conductivity meter 8226 can be installed on a pipe using a fitting S020.

-  ▪ Choose the appropriate installation position in order to avoid the formation of bubbles or air pockets.
- Install the S020 fitting into the pipe using the instructions on the user manual.

 Always make sure that the fluid flows within the hole of the conductivity sensor.



① Mounting of the transmitter on a horizontal or vertical pipe.

② Mounting of the device on the bore of the tank.

Figure 5 : Mounting positions of the device

|   |   |   |  |   |
|---|---|---|--|---|
|  |  |  |  |  |
|   | with a tee fitting  | with a saddle   | with a plastic spigot  | with a stainless steel spigot   |
| DN15  | 187   | -   | -  | -   |
| DN20  | 185   | -   | -  | -   |
| DN25  | 185   | -   | -  | -   |
| DN32  | 188   | -   | -  | -   |
| DN40  | 192   | -   | -  | 188   |
| DN50  | 198   | 223   | -  | 193   |
| DN65  | 198   | 222   | 206  | 199   |
| DN80  | -   | 226   | 212  | 204   |
| DN100   | -   | 231   | 219  | 214   |
| DN110   | -   | 227   | -  | -   |
| DN125   | -   | 234   | 254  | 225   |
| DN150   | -   | 244   | 261  | 236   |
| DN180   | -   | 268   | -  | -   |
| DN200   | -   | 280   | 282  | 257   |

Figure 6 : Installation height with relation to the DN of the pipe [mm]

→ Install the device into the fitting (see Figure 7).

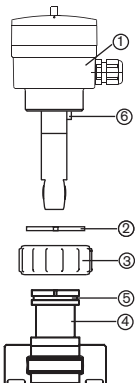
|   |   |
|---|---|
|  | <p>→ Unscrew the nut ③ of the device.</p> <p>→ Insert the nut ③ on the fitting ④.</p> <p>→ Clip the snap ring ② into the groove ⑤.</p> <p>→ Insert the conductivity sensor into the fitting, making sure of the correct positioning of the lug ⑥ into its housing on the fitting.</p> <p>→ Screw the nut ③ manually on the device.</p> <p>If the mounting is correct, the housing ① of the device should be tightly positioned.</p> |
|---|---|

Figure 7 : Installation of the device into the S020 fitting

## 7.4. Wiring

### DANGER

**Risk of injury due to electrical voltage.**

- Shut down and isolate the electrical power source before carrying out work on the system.
- Observe all applicable accident protection and safety regulations for electrical equipment.



Use a filtered and regulated 12-30 V DC power supply (see chap. [6.3.3](#)).



- Use shielded cables with a temperature limit of 80 °C minimum.
- For normal operating conditions, the measuring signal can be transmitted by a cable of 0.75 mm<sup>2</sup> cross section.
- Do not bring connection cables near high voltage or high frequency cables.
- If this cannot be avoided, observe a min. distance of 30 cm.

### 7.4.1. Wiring a 12-30 V DC version with a male EN 175301-803 connector

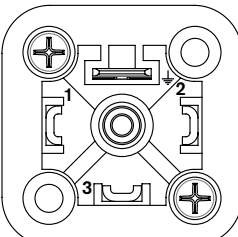
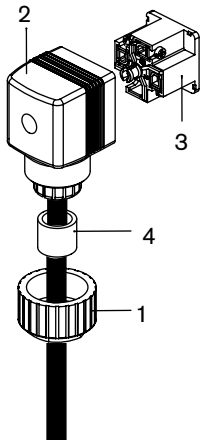
|   |   |
|---|---|
|  | <p>1: V+ (12-30 V DC)</p> <p>2: 4-20 mA output</p> <p>3: 0V</p> <p>⏏ : functional earth</p> |
|---|---|

Figure 8 : Pin assignment on the EN 175301-803 male fixed connector

|   |   |
|---|---|
|  | <ul style="list-style-type: none"> <li>→ Unscrew the nut <b>1</b> of the cable gland.</li> <li>→ Remove the terminal block <b>3</b> from the housing <b>2</b>.</li> <li>→ Insert the cable into the nut <b>1</b>, through the seal <b>4</b>, and into the cable gland and then through the housing <b>2</b>.</li> <li>→ Connect the wires on the terminal block <b>3</b> (see <a href="#">Figure 10</a>).</li> <li>→ Position the terminal block <b>3</b> in steps of 90° then put it back into the housing <b>2</b>, pulling gently on the cable so that the wires do not clutter the housing.</li> <li>→ Screw the nut <b>1</b> of the cable glands.</li> </ul> |
|---|---|

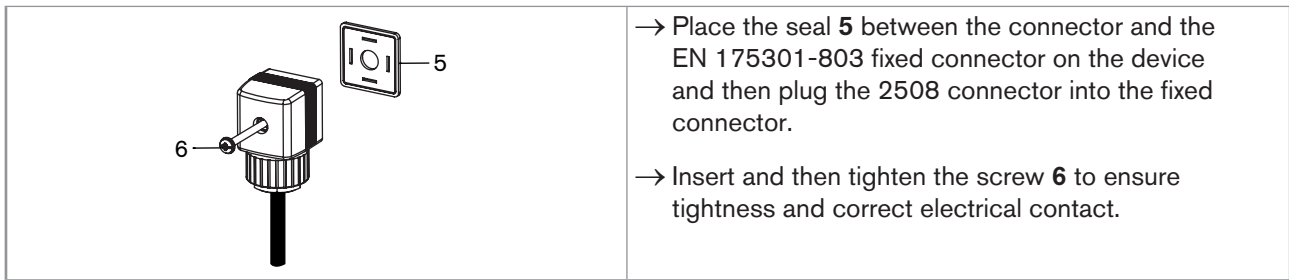


Figure 9 : Assembling the female connector type 2508 (supplied)

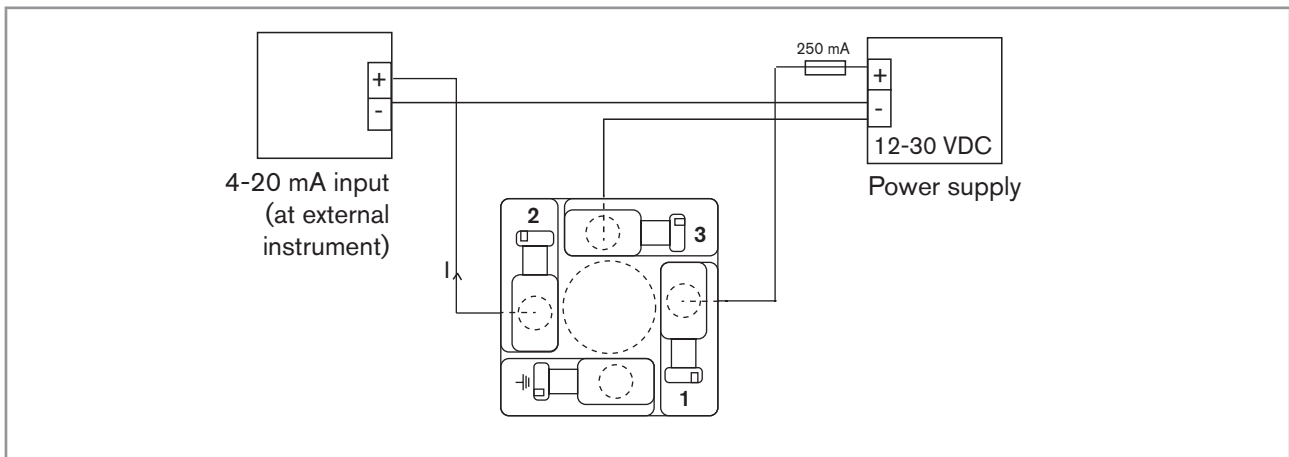


Figure 10 : Wiring of the 4-20 mA output

### 7.4.2. Wiring of a 12-30 V DC version with cable glands and no relays

**!** Seal the unused cable gland using the stopper supplied, to make sure the device is tight.

- Loosen the screw from the lid.
- Flip the lid.
- Loosen the 4 screws from the cover of the housing.
- Remove the cover.
- Loosen the nuts of the cable glands.
- Insert the cable into the nut then into the cable gland, and wire according to [Figure 12](#) or [Figure 13](#).

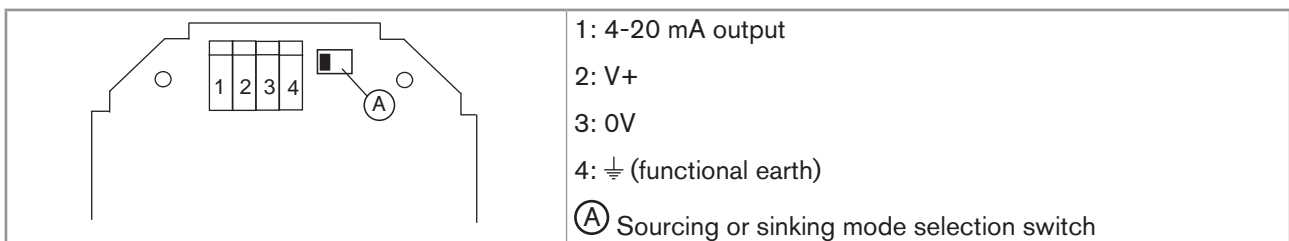

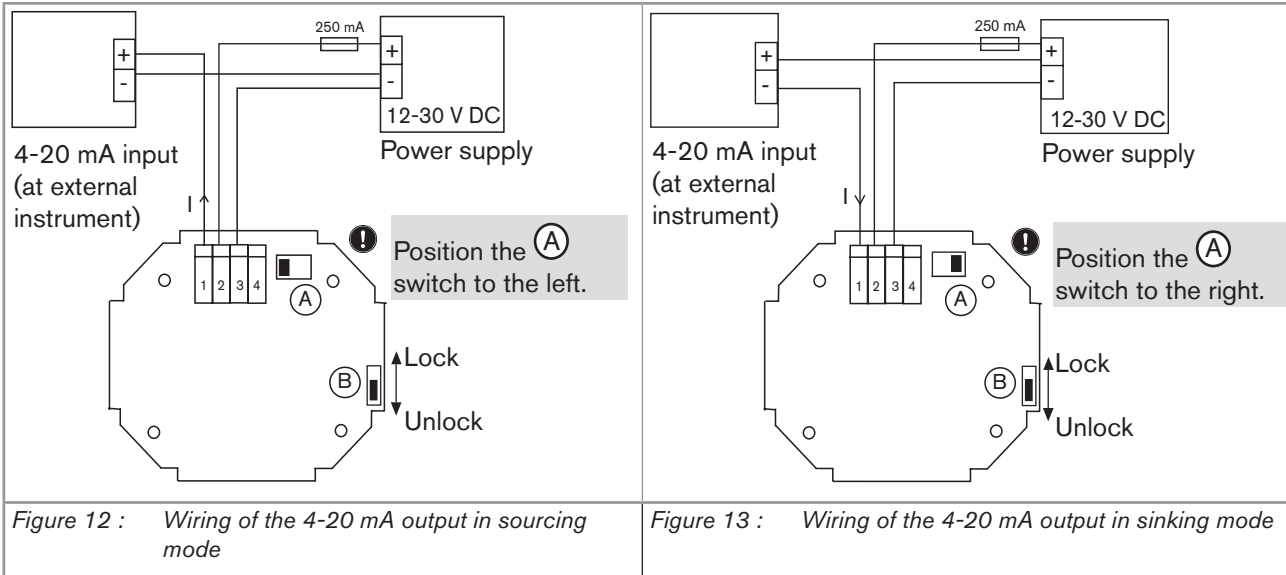


Figure 11 : Terminal assignment of a version with cable glands, and no relays, energized with 12-30 V DC

MAN 1000189134 EN Version: A Status: RL (released | freigegeben) printed: 22.09.2017

**!** Use the switch **(B)** to lock the  key to prevent unauthorized access to the configuration of the device.

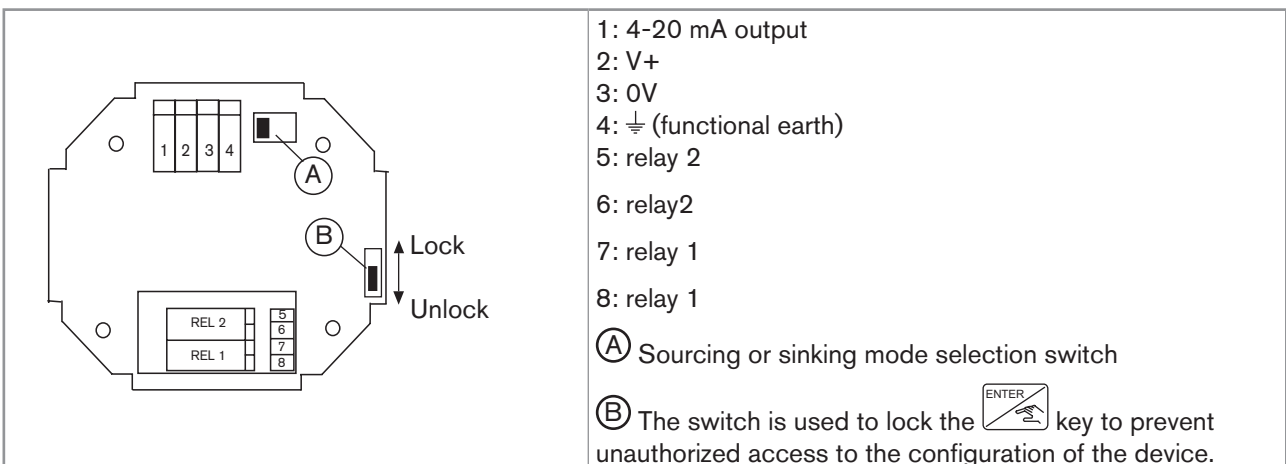
The 4-20 mA output can be wired in either sourcing or sinking mode.



### 7.4.3. Wiring of a 12-30 V DC version with cable glands and relays

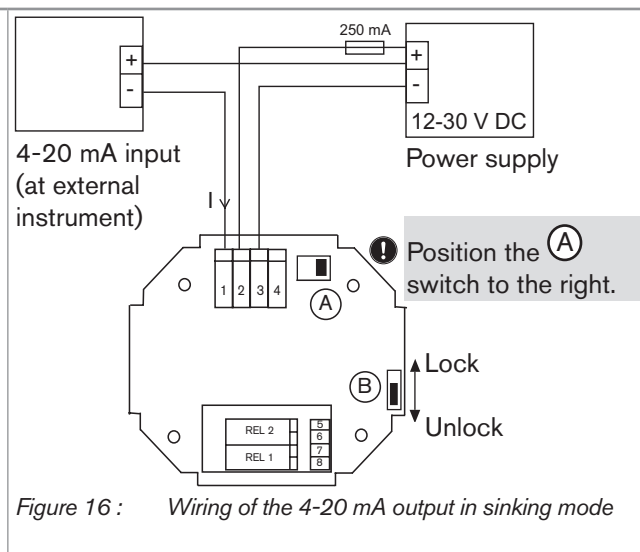
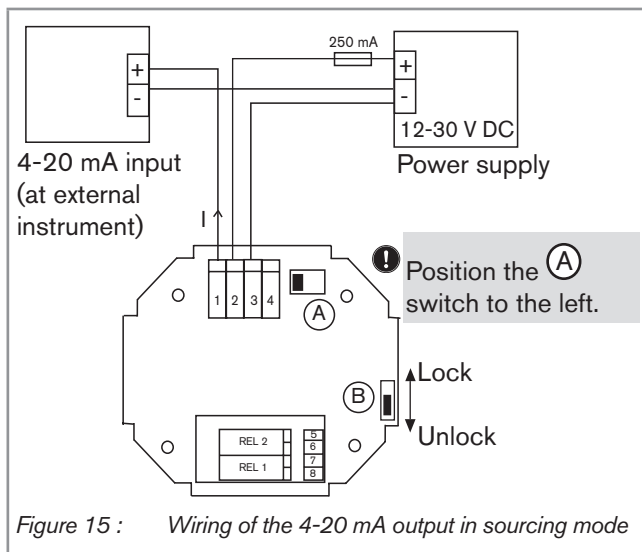
**!** Seal the unused cable gland using the stopper supplied, to make sure the device is tight.

- Loosen the screw from the lid.
- Flip the lid.
- Loosen the 4 screws from the cover of the housing.
- Remove the cover.
- Loosen the nuts of the cable glands.
- Insert the cable into the nut, then into the cable glands and wire according to [Figure 15](#) or [Figure 16](#) and/or [Figure 17](#).

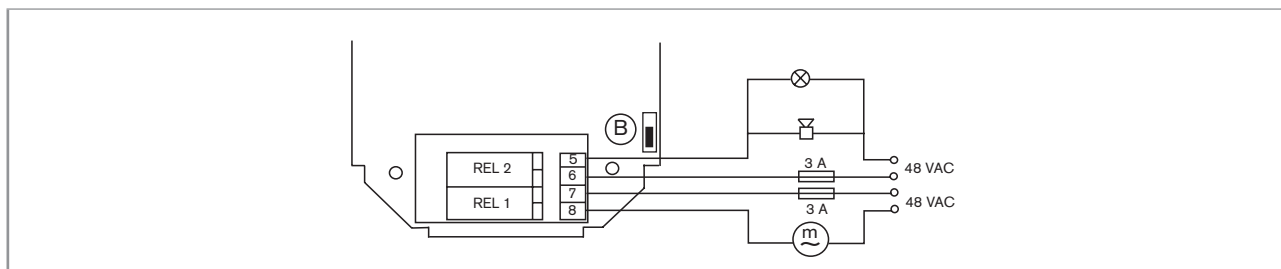


**Figure 14 :** Terminal assignment of a version with cable glands, and relays, energized with 12-30 V DC

The 4-20 mA output can be wired in either sourcing or sinking mode.



**!** For safety reasons, secure the cables using a non-conducting cable clip.



#### 7.4.4. Wiring of a 115/230 V AC version

**!** Seal the unused cable gland using the stopper supplied to make sure the device is tight.

This version is wired via 2 cable glands.

- Loosen the screw from the lid.
- Flip the lid.
- Loosen the 4 screws from the cover of the housing.
- Remove the cover.
- Loosen the nuts of the cable glands.
- Insert the cable into the nut, then into the cable glands and wire according to [Figure 17](#) and/or [Figure 19](#) or [Figure 20](#).
- Wire the relays - if available on your version of the device - similarly to the relays of the 12-30 V DC version (see [Figure 17](#)).

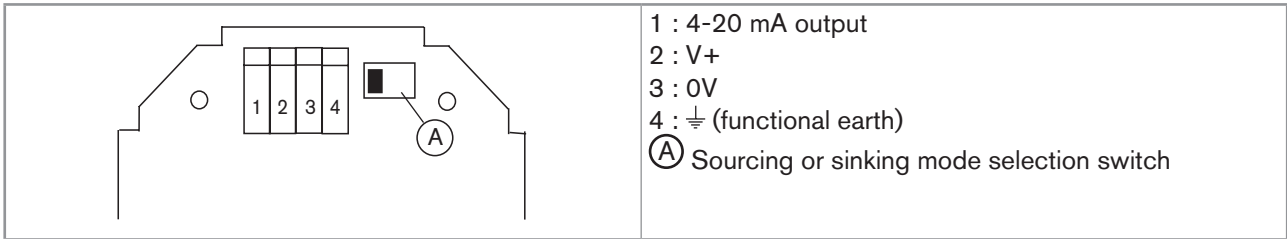

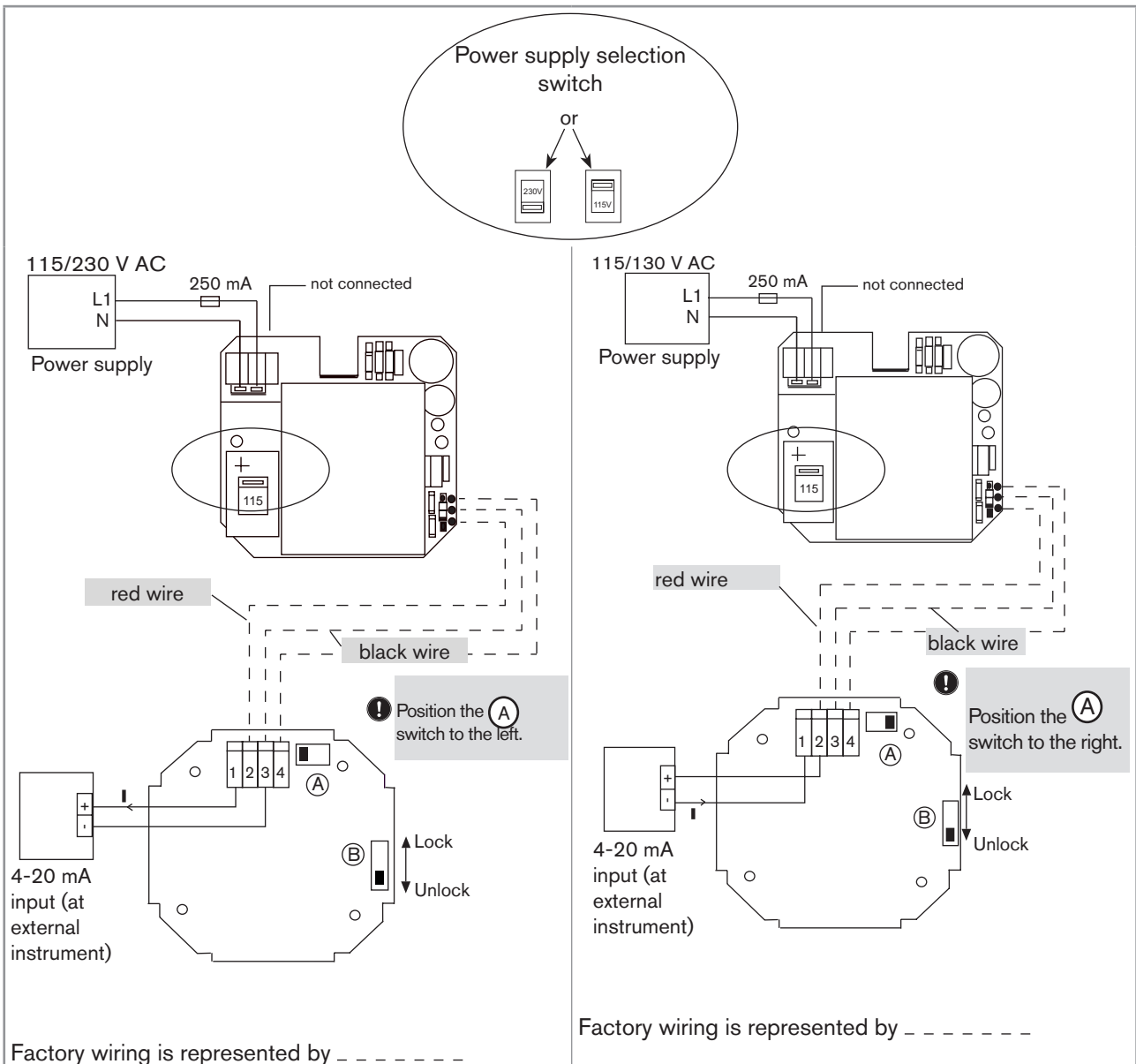


Figure 18 : Terminal assignment for the 115/230 V AC version

- Switch to select either a 115 or 230 V AC power supply.
- Use the switch (B) to lock the  key to prevent unauthorized access to the configuration of the device.

The 4-20 mA output can be wired in either sourcing or sinking mode.



MAN 1000189134 EN Version: A Status: RL (released | freigegeben) printed: 22.09.2017



## 8. OPERATING AND COMMISSIONING

### 8.1. Safety instructions



#### WARNING

##### **Risk of injury due to non-conforming operating.**

Non-conforming operating could lead to injuries and damage the device and its surroundings.

- The operators in charge of operating must have read and understood the contents of this manual.
- In particular, observe the safety recommendations and intended use.
- The device/installation must only be operated by suitably trained staff.

##### **Danger due to non-conforming commissioning.**

Non-conforming commissioning could lead to injuries and damage the device and its surroundings.

- Before commissioning, make sure that the staff in charge have read and fully understood the contents of the manual.
- In particular, observe the safety recommendations and intended use.
- The device / the installation must only be commissioned by suitably trained staff.



Protect this device against electromagnetic interference, ultraviolet rays and, when installed outdoors, the effects of the climatic conditions.

### 8.2. Operating levels

The device has two operating levels: the Process level and the Configuration level.

The Process level makes it possible:

- to read the measured value of conductivity,
- to read the measured value of temperature,
- to read the value of the 4-20 mA output,
- to activate the HOLD mode.

The Configuration level comprises two menus (Parameters and Test) and makes it possible:

- to set the device parameters.
- to test some device parameters.
- to calibrate the device.

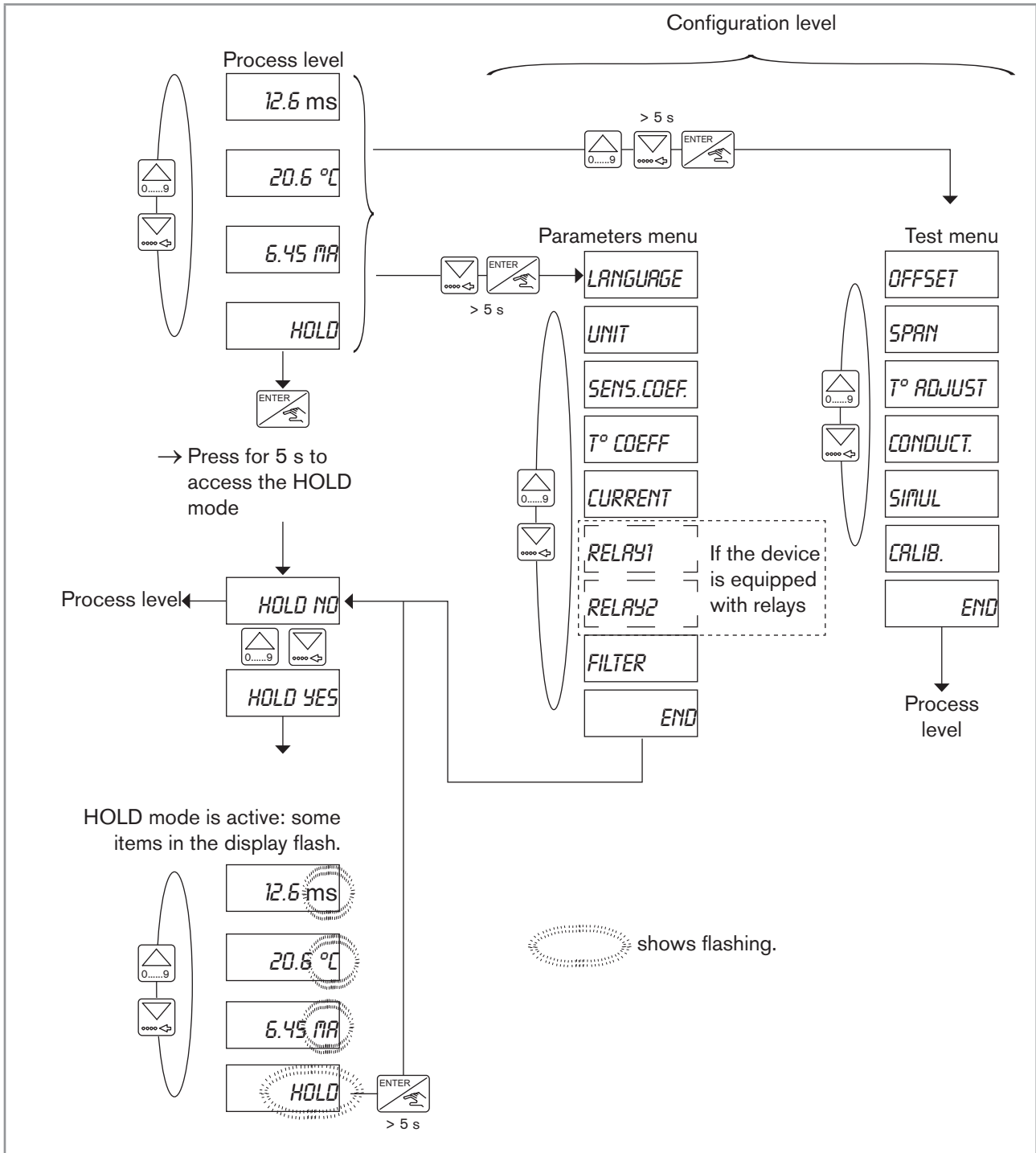


Figure 21 : Process level and Configuration level

### 8.3. Using the navigation keys

| You want to...  | press...   |
|---|--|
| navigate through parameters,  | <ul style="list-style-type: none"> <li>▫  to go to the next parameter.</li> <li>▫  to go to the previous parameter.</li> </ul>                         |
| access the Parameters menu,   | +  simultaneously for 5 s.   |
| access the Test menu,   | +  +  simultaneously for 5 s.  |
| <ul style="list-style-type: none"> <li>▫ select a displayed parameter,</li> <li>▫ confirm the displayed value,</li> <li>▫ save the modified parameters and go back to the Process level (only from the "END" parameter),</li> </ul> |  |
| modify a digital value,   | <ul style="list-style-type: none"> <li>▫  to increment the selected numerical value.</li> <li>▫  to select the numerical value on the left.</li> </ul> |
| attribute a "+" or "-" sign to the value of the temperature of the "T° ADJUST" parameter,   | until the sign ("+" ou "-") starts blinking, then on , to modify the sign.   |
| activate or deactivate the HOLD mode (only from the Process level),   | for 5 s.   |
| leave the Teach-in procedure (only accessible from the "T°COEFF" parameter),  | +  simultaneously for 5 s.   |

You can lock the key to prevent unauthorized access to the configuration of the device (see [Figure 12](#)).

### 8.4. Description of the display

The diagram shows the device's display and keypad. The display shows 'burkert' and 'COND' at the top, with a measured value of '125.6' and a unit of 'mS'. The keypad includes an up arrow key, a down arrow key, an ENTER key, and two relay status indicators labeled 'REL 1' and 'REL 2'.

- Measured value:** 125.6
- Chosen engineering unit:** mS
- Buttons:** Up arrow, Down arrow, ENTER
- Relays:** REL 1, REL 2

Callouts and functions:

- Measured value:**
  - Scrolling down the parameters
  - Incrementing the figure selected
- Chosen engineering unit:**
  - Selecting the displayed parameter
  - Confirming the displayed value
  - Validating the settings
- REL 1, REL 2:** State of the relays 1 and 2 (indicator on = contact closed)
- Up arrow key:**
  - Scrolling down the parameters
  - Selecting the figure on the left

Figure 22 : Description of the keys and indicators of the display

MAN 1000189134 EN Version: A Status: RL (released | freigegeben) printed: 22.09.2017

## 8.5. Details of the Process level

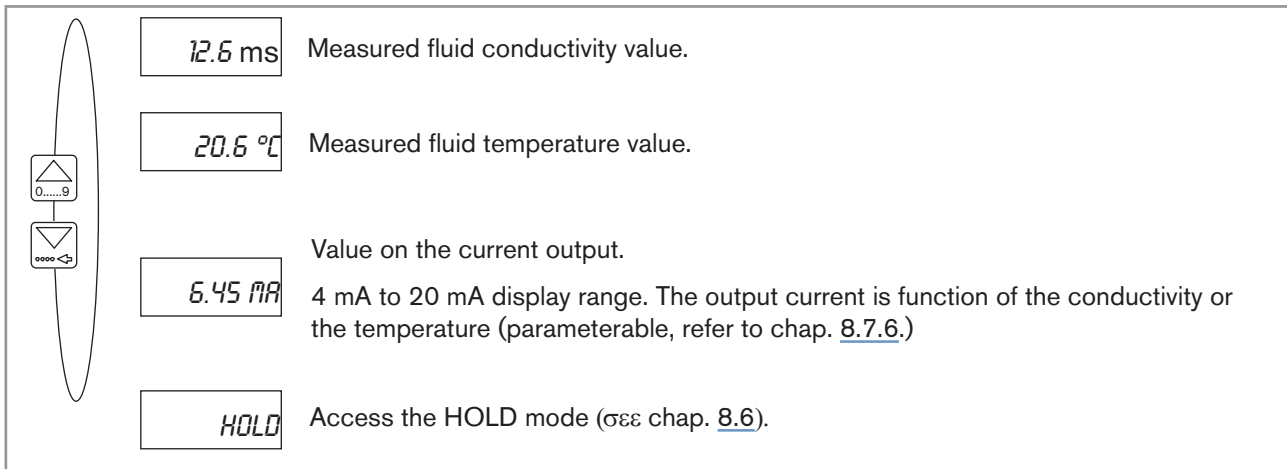


Figure 23 : Details of the Process level



If an "ERROR" message appears, refer to chap. "9.3. If you encounter problems".

## 8.6. HOLD mode

→ Go to chap. 8.2 to access the HOLD mode.

The HOLD mode allows for maintenance work to be performed while freezing the process.

In practice, when the device is in Hold mode:

- generates an output current for the last measured value,
- saves the former state of the relays,
- refuses access to the Parameters and Test menus,
- makes the engineering units of the displayed values blink in the Process level.

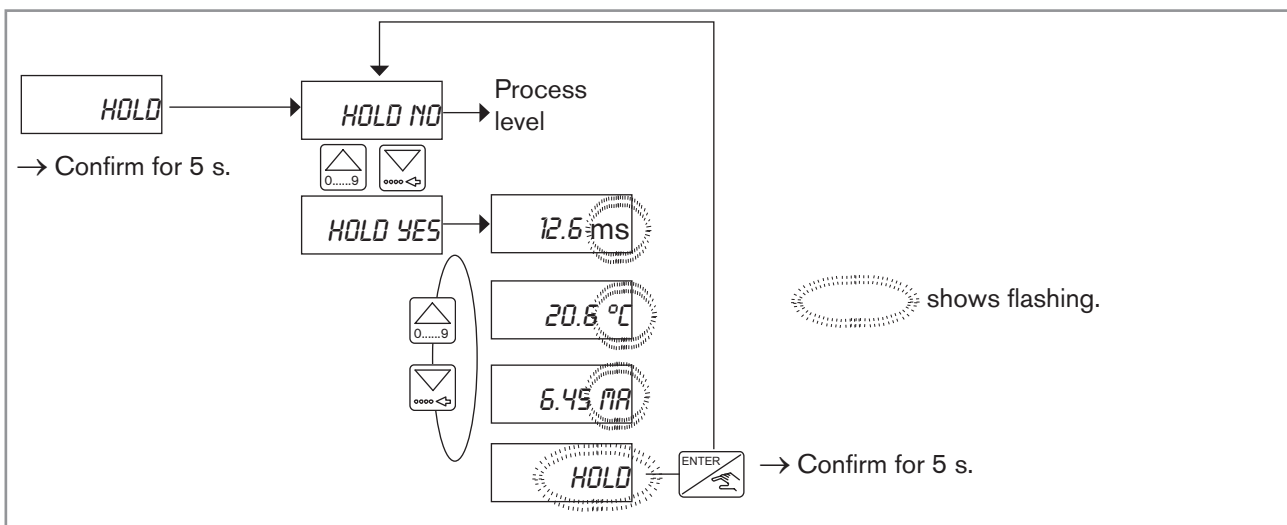


Figure 24 : Activating the HOLD mode

## 8.7. Parameters menu

→ To access the Parameters menu from the Process level, press and simultaneously for 5 seconds.

The table below shows the paragraphs referring to each parameter of the Parameters menu:

| Parameter  | Use this parameter to...   | related chap.                                  |
|------------|--|--|
| LANGUAGE   | choose the language of the display between English, German, French, Italian or Spanish.  | <a href="#">8.7.1</a>                          |
| UNIT       | <ul style="list-style-type: none"> <li>modify the units of conductivity and temperature.</li> <li>choose the number of decimals for the displayed values of conductivity.</li> </ul> | <a href="#">8.7.2</a>                          |
| SENS.COEF. | parameter the coefficient of the sensor.   | <a href="#">8.7.3</a> or <a href="#">8.7.4</a> |
| T° COEFF   | choose the temperature compensation mode: <ul style="list-style-type: none"> <li>linear</li> <li>automatic</li> <li>Teach-In</li> </ul>  | <a href="#">8.7.5</a>                          |
| CURRENT    | configure the measuring range of the conductivity or the temperature, for the current output.  | <a href="#">8.7.6</a>                          |
| RELAY 1    | parameter the relay 1 (if the device is equipped with relays).   | <a href="#">8.7.7</a>                          |
| RELAY 2    | parameter the relay 2 (if the device is equipped with relays).   | <a href="#">8.7.7</a>                          |
| FILTER     | select a damping effect (among 10 levels available) to prevent fluctuation within the output current and the display.  | <a href="#">8.7.8</a>                          |
| END        | go back to the Process level and save the new parameters set.  | -  |

### 8.7.1. Choosing the display language

To access the parameter, see chap. [8.2](#).

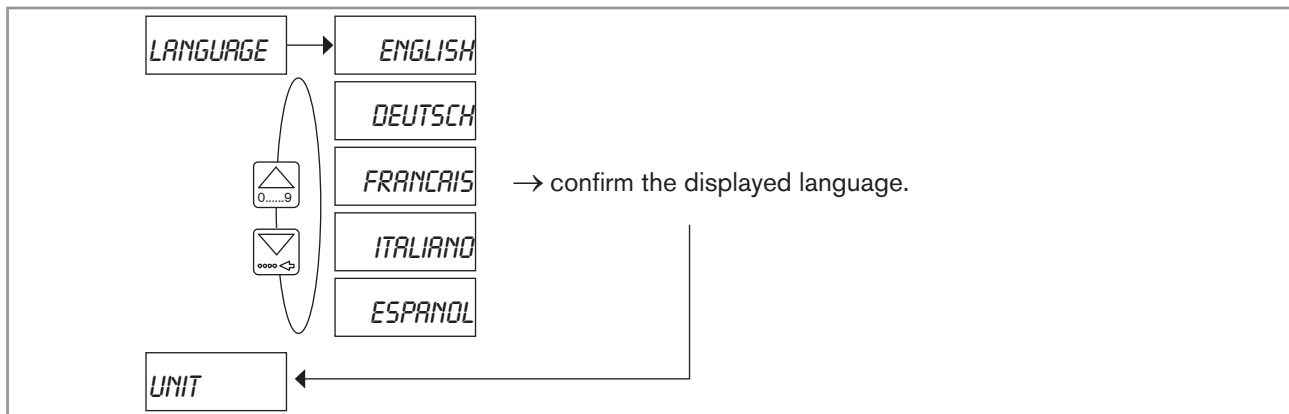



Figure 25 : Diagram of the "LANGUAGE" parameter of the Parameters menu

→ If you do not want to adjust another parameter, go to the "END" parameter of the Parameters menu and press  to save the settings and go back to the Process level.

### 8.7.2. Choosing units of conductivity and temperature

To access the parameter, see chap. 8.2.

**!** If the unit is changed, the "CURRENT" and "RELAY" parameters of the Parameters menu are automatically modified.

The "UNIT" parameter makes it possible to choose:

- Choose the unit of conductivity.
  - $\mu$ Siemens/cm are always displayed in integer numbers,
  - Siemens/cm are always displayed in decimals.
- Choose the unit of temperature. The displayed value of temperature always comprises 2 decimals.

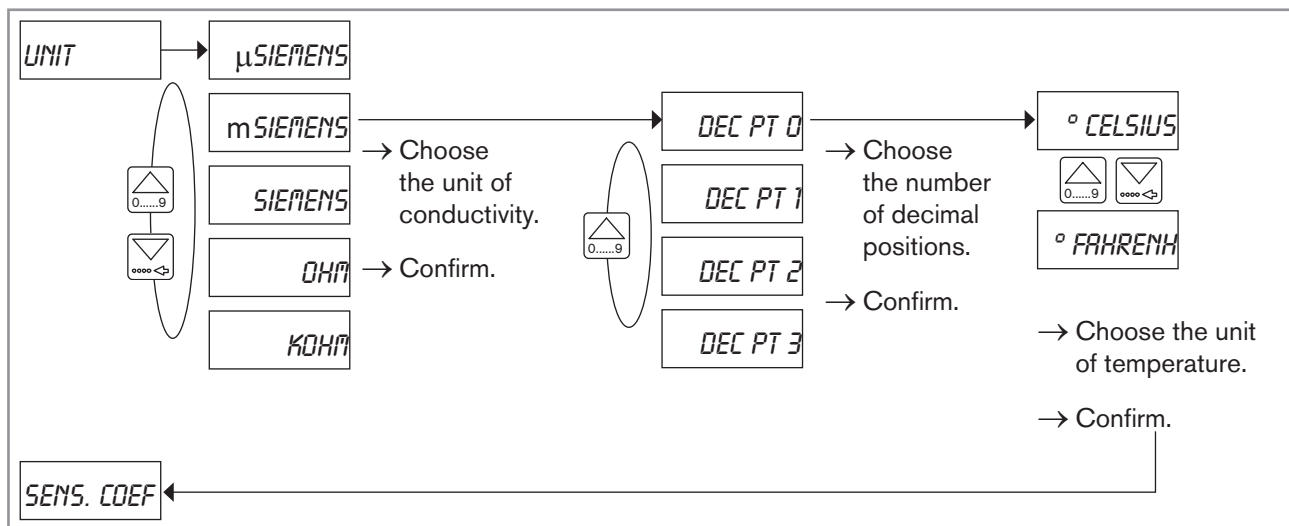



Figure 26 : Diagram of the "UNIT" parameter of the Parameters menu

→ If you do not want to adjust another parameter, go to the "END" parameter of the Parameters menu and press  to save the settings and go back to the Process level.

### 8.7.3. Adjusting the coefficient of the sensor with relation to the process

To access the parameter, see chap. 8.2.

The coefficient of the sensor is used for converting the electrical signal into a unit of conductivity, with relation to the cell constant and the material of the fitting used.

**!** For high-accuracy applications, recalculate the coefficient of the sensor after a certain period of use that varies depending on the application (see chap. 8.7.4).

The coefficient of the sensor is specific to each conductivity sensor and dependent on the material and diameter of the fitting used.

It is calculated by using the equation  $K = C_s \times C_f$ :

- "K" being the **coefficient of the sensor** to be determined and parametered.
- "C<sub>s</sub>" being the **cell constant** of the conductivity sensor.  
This value is written on a label stucked on the housing of the device or on the cable of the conductivity sensor located inside its housing.
- "C<sub>f</sub>" being the **correction factor** of the S020 fitting used (see [Table 1](#) hereafter).

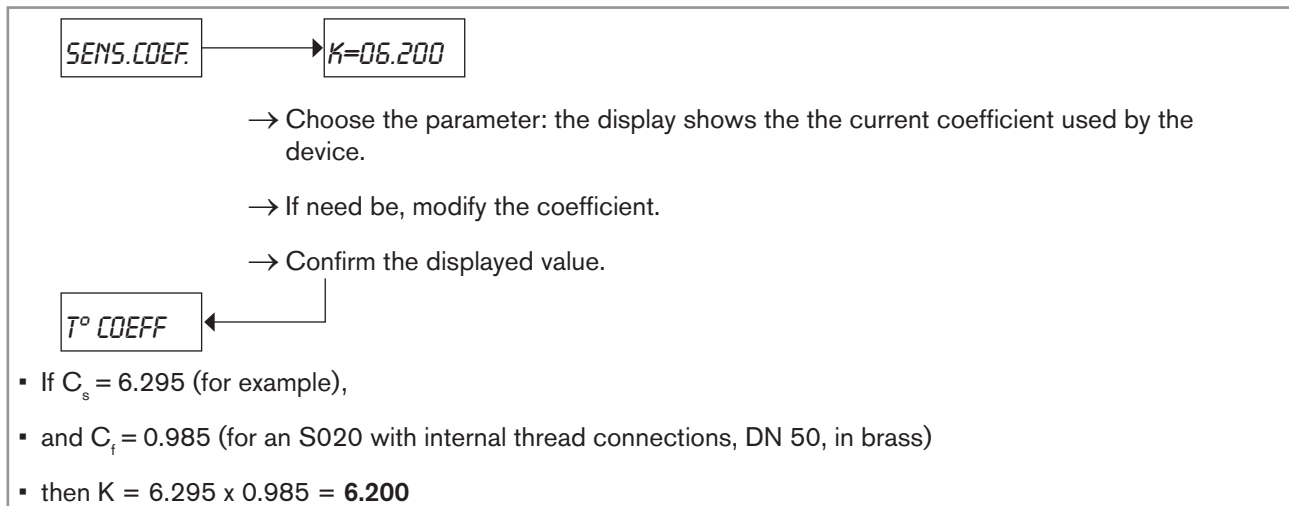


Figure 27 : Example showing how to calculate and parameter the coefficient of the sensor, used with a brass-based, DN 50, S020 fitting

| DN   | True union connections |       |       | Fittings with weld end connections |                 |       |       | Fittings with internal or external thread connections |                 | Saddle |
|------|------------------------|-------|-------|------------------------------------|-----------------|-------|-------|---|-----------------|--------|
|      | PVDF                   | PP    | PVC   | Brass                              | Stainless steel | PVDF  | PP    | Brass   | Stainless steel | PVC    |
| <32  | 1.113                  | 1.098 | 1.093 | 0.991                              | 0.989           | -     | -     | 0.991   | 0.989           | -      |
| 32   | 1.113                  | 1.098 | 1.093 | 0.991                              | 0.989           | -     | -     | 0.991   | 0.989           | -      |
| 40   | 1.049                  | 1.045 | 1.045 | 0.989                              | 0.989           | -     | -     | 0.989   | 0.989           | -      |
| 50   | 1.022                  | 1.021 | 1.022 | 0.985                              | 0.983           | -     | -     | 0.985   | 0.983           | -      |
| 65   | -                      | -     | -     | -                                  | 0.993           | 1.020 | 1.019 | -   | -               | 1.025  |
| 80   | -                      | -     | -     | -                                  | 0.995           | 1.020 | 1.019 | -   | -               | 1.022  |
| 100  | -                      | -     | -     | -                                  | 0.998           | 1.019 | 1.017 | -   | -               | 1.010  |
| >100 | -                      | -     | -     | -                                  | 1.000           | 1.000 | 1.000 | -   | -               | 1.000  |

Table 1 : "C<sub>f</sub>" correction factors of S020 fittings

→ If you do not want to adjust another parameter, go to the "END" parameter of the Parameters menu and press to save the settings and go back to the Process level.

### 8.7.4. Adjusting the coefficient of the sensor after a certain period of use

To access the parameter, see chap. [8.2](#).

The cell constant can change over time due to formation of deposits on the conductivity sensor or on the fitting.

- Regularly clean the conductivity sensor with a product compatible with the materials of the device.
- Check conductivity measurement regularly, using a reference solution or a reference device. A change in the cell constant will result in incorrect measurement.
- Calculate the new coefficient of the sensor using the equation  $K_{\text{new}} = K_{\text{current}} \times \text{Cond}_{\text{ref}} / \text{Cond}_{8226}$  :
  - "K<sub>new</sub>" being the new value for the coefficient of the sensor.
  - "K<sub>current</sub>" being the current value for the coefficient of the sensor (calculated in paragraph 8.7.3).
  - "Cond<sub>ref</sub>" being the value of conductivity measured with the reference device.
  - "Cond<sub>8226</sub>" being the value of conductivity measured by the device.

Cond<sub>ref</sub> (calibration with a 10.00 mS solution) = 10.00

K<sub>current</sub> = 6.200

Cond<sub>8226</sub> = 10.50 mS

$K_{\text{new}} = 6.295 \times 10.00 / 10.50 = 5.995$


→ Choose the parameter: the display shows the the current coefficient used by the device.

→ If need be, modify the coefficient.

→ Confirm the displayed value.

T° COEFF

Figure 28 : Example of how to calculate and parameter the new coefficient of the sensor

- If you do not want to adjust another parameter, go to the "END" parameter of the Parameters menu and press  to save the settings and go back to the Process level.

### 8.7.5. Adjusting the temperature compensation coefficient

To access the parameter, see chap. 8.2.

Conductivity varies according to the temperature. The temperature compensation coefficient is used to determine the conductivity for a fluid temperature of 25 °C.

The device has three modes of temperature compensation:

- Linear
- Automatic
- Teach-In



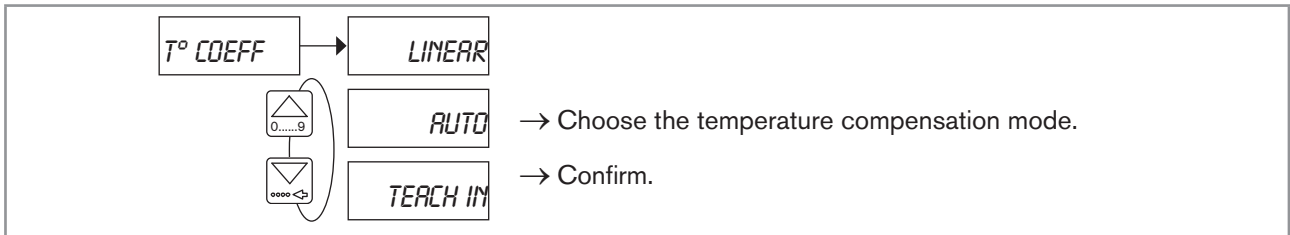


Figure 29 : Diagram of the parameter "T°COEFF" of the Parameters menu

**1. Linear temperature compensation**

In some cases, the linear compensation is precise enough to monitor and control the process if the fluid temperature is always > 0 °C. For this compensation mode enter a value - held as the average compensation value - for the temperature and the conductivity range.

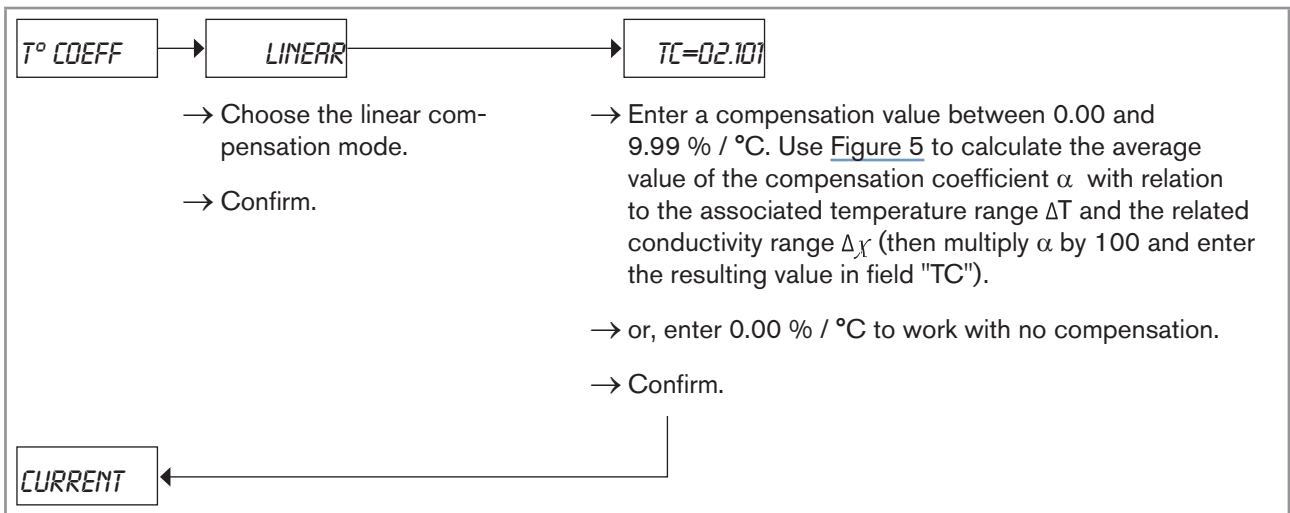


Figure 30 : Setting the linear compensation mode

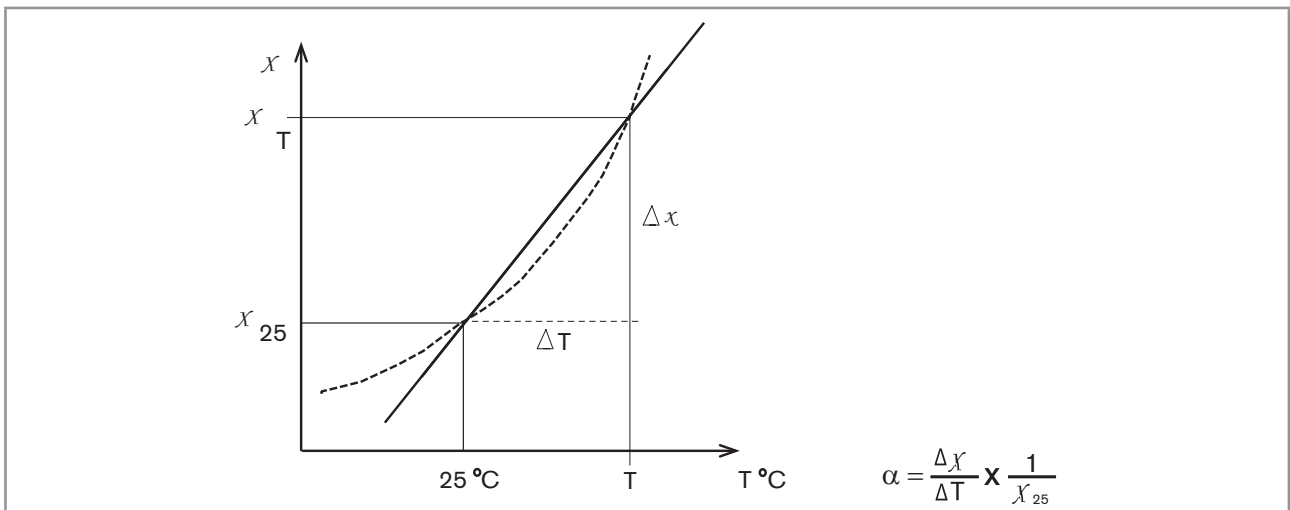


Figure 31 : Curve and equation for linear compensation

→ If you do not want to adjust another parameter, go to the "END" parameter of the Parameters menu and press to save the settings and go back to the Process level.

MAN 1000189134 EN Version: A Status: RL (released | freigegeben) printed: 22.09.2017

## 2. Automatic temperature compensation


The compensation curves for NaOH, HNO<sub>3</sub> and NaCl apply to a fluid temperature range of 10-80°C and for the following concentrations:

- NaCl: 60 mg/l to 270 g/l
- NaOH: 1.0 %
- HNO<sub>3</sub>: 1.0 %

The compensation curve H<sub>2</sub>SO<sub>4</sub> applies to a fluid temperature range of 5-55 °C:

- H<sub>2</sub>SO<sub>4</sub>: 20.0 %

The "SPECIAL" parameter stores the compensation curve of your process, achieved through the Teach-in procedure.

 The "SPECIAL" parameter is only available when the Teach-in procedure is completed (see hereafter).

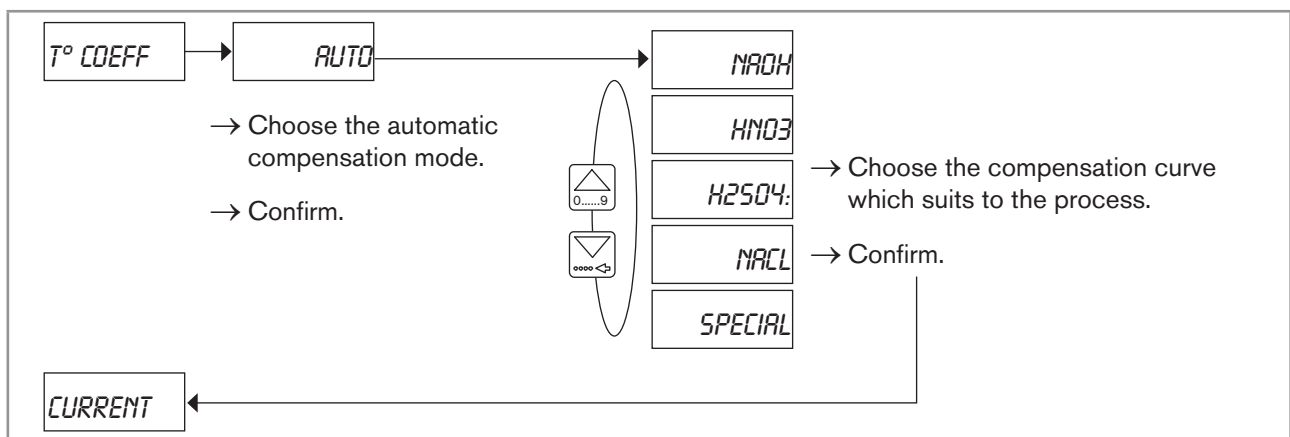




Figure 32 : Setting the automatic temperature compensation mode



→ If you do not want to adjust another parameter, go to the "END" parameter of the Parameters menu and press  to save the settings and go back to the Process level.

## 3. Temperature compensation through Teach-In

This mode enables the practical definition of the compensation curve over a specific temperature range.

 Avoid the formation of bubbles on the surface of the conductivity sensor.

▪ The increase in temperature must be slow in order to compensate the thermal resistance of the temperature sensor.

▪ To interrupt the Teach-In procedure during measurement, simultaneously press keys  and  for 5 seconds. The compensation curve is not stored.

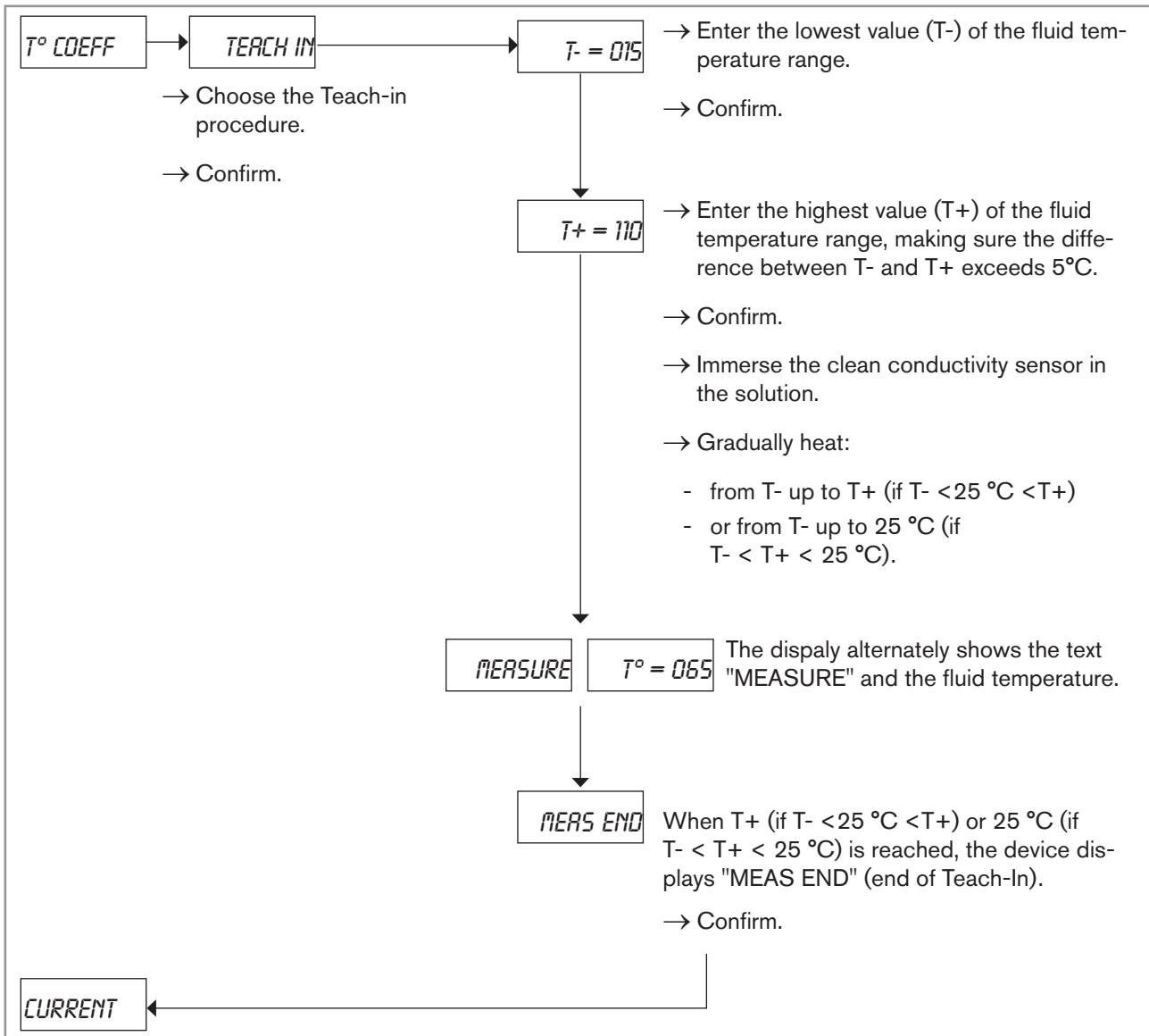


Figure 33 : Definition of the compensation curve through Teach-In

→ Activate "SPECIAL" in the "T° COEFF" parameter to use the compensation curve obtained with the Teach-in procedure.

If an "ERROR" message appears, refer to chap. 9.3.

→ If you do not want to adjust another parameter, go to the "END" parameter of the Parameters menu and press to save the settings and go back to the Process level.

### 8.7.6. Configuring the current output

To access the parameter, see chap. 8.2.

You can use this parameter to configure the measurement range of the conductivity or the temperature for the 4-20 mA current output.



Refer to chap. 8.7.2 to parameter the units of conductivity and temperature measurements as well the decimals for the display of conductivity.

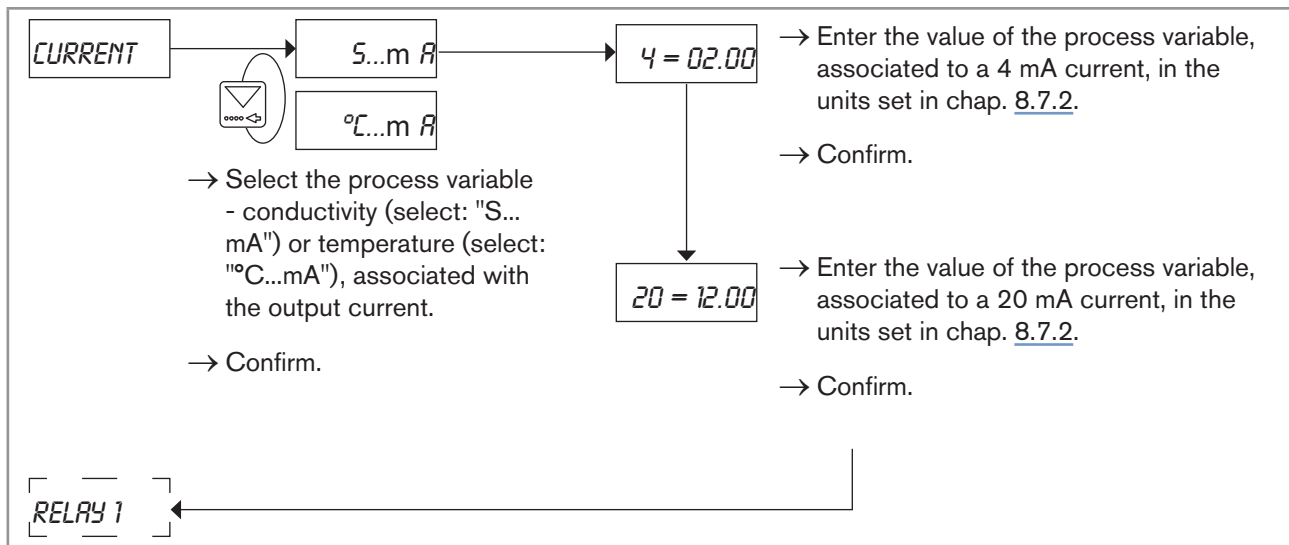


Figure 34 : Diagram of the "CURRENT" parameter of the Parameters menu

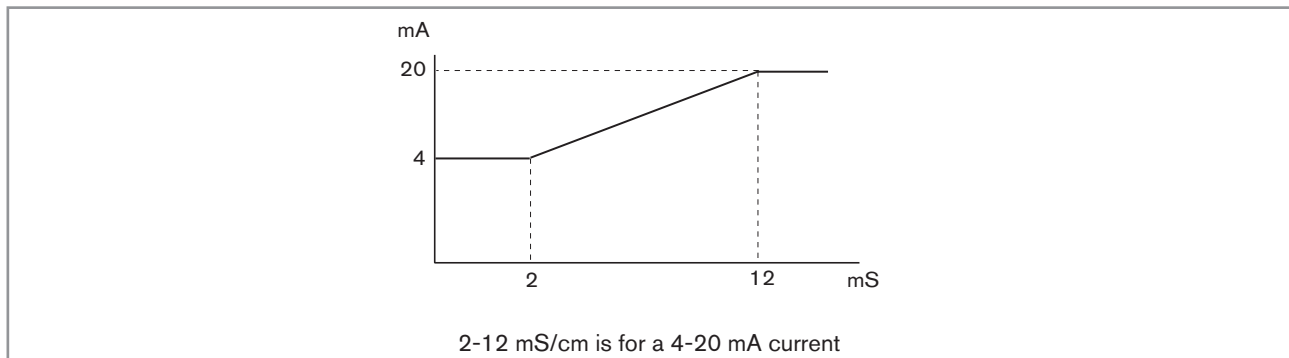


Figure 35 : Example of the correlation between a 4-20 mA output and its corresponding conductivity range

→ If you do not want to adjust another parameter, go to the "END" parameter of the Parameters menu and press



to save the settings and go back to the Process level.

### 8.7.7. Setting the switching thresholds of the relays (if the device is equipped with relays)

To access the parameter, see chap. 8.2.



Also refer to chap. 8.7.2 to parameter the engineering units and the decimals of the display.

The relay switches depending on the value of conductivity or temperature.

→ Enter two switching thresholds for each relay:

- 1- and 1+ (for relay 1)
- 2- and 2+ (for relay 2)

The operating of both relays is hysteresis. You can invert the relays and set a time delay of 0 to 180 seconds. This time delay prevents rapid switching of the relays, for example, when time for homogenization is required (e.g. measurements within tanks with agitators).

- When the process variable exceeds a set threshold value, the device factors in the time delay before switching the relay.
- If the process variable falls below a set threshold value before the time delay elapses, then the relay will not switch.

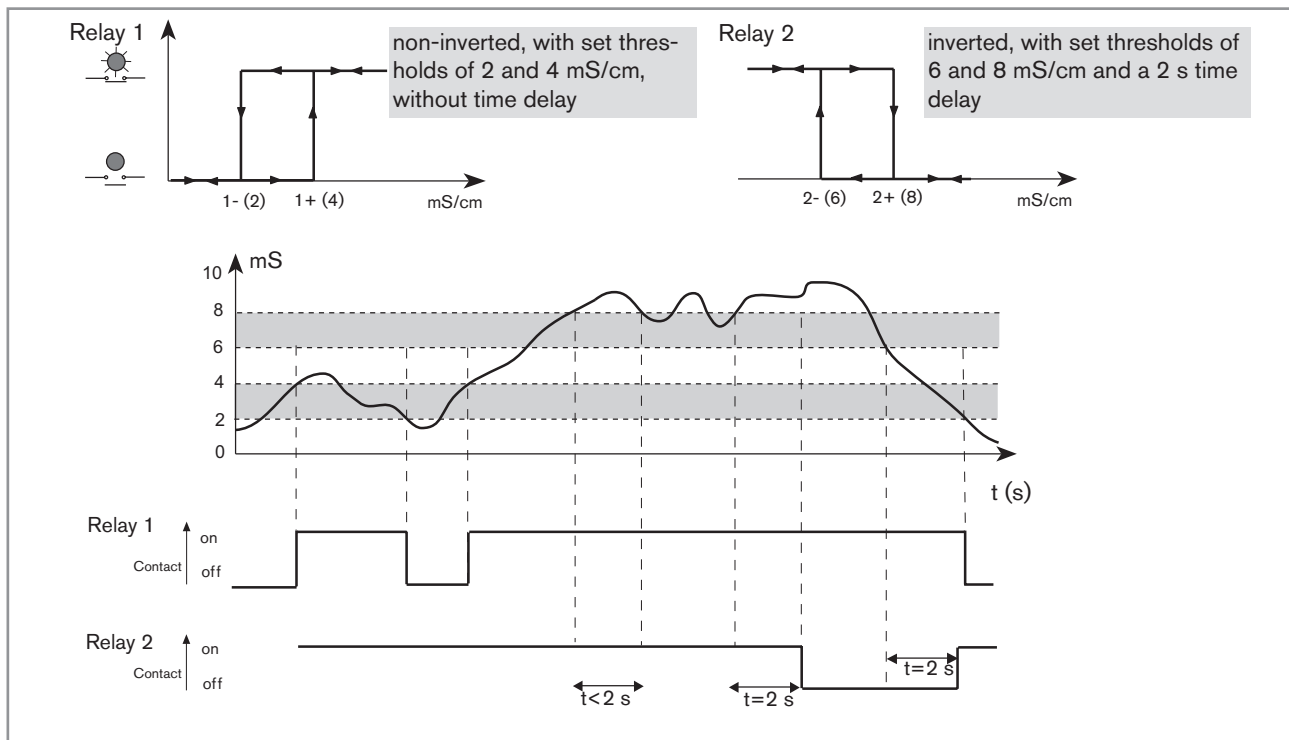


Figure 36 : Example: Status of relays 1 and 2 depending on its operating, the value of conductivity and the value of the time delay

#### Relay 1

You can use the relay 1 to switch a solenoid valve or a pump, depending on the set threshold values.



To deactivate a relay, set the thresholds as follows: 1- = 1+ = 0.00 or 2- = 2+ = 0.00.

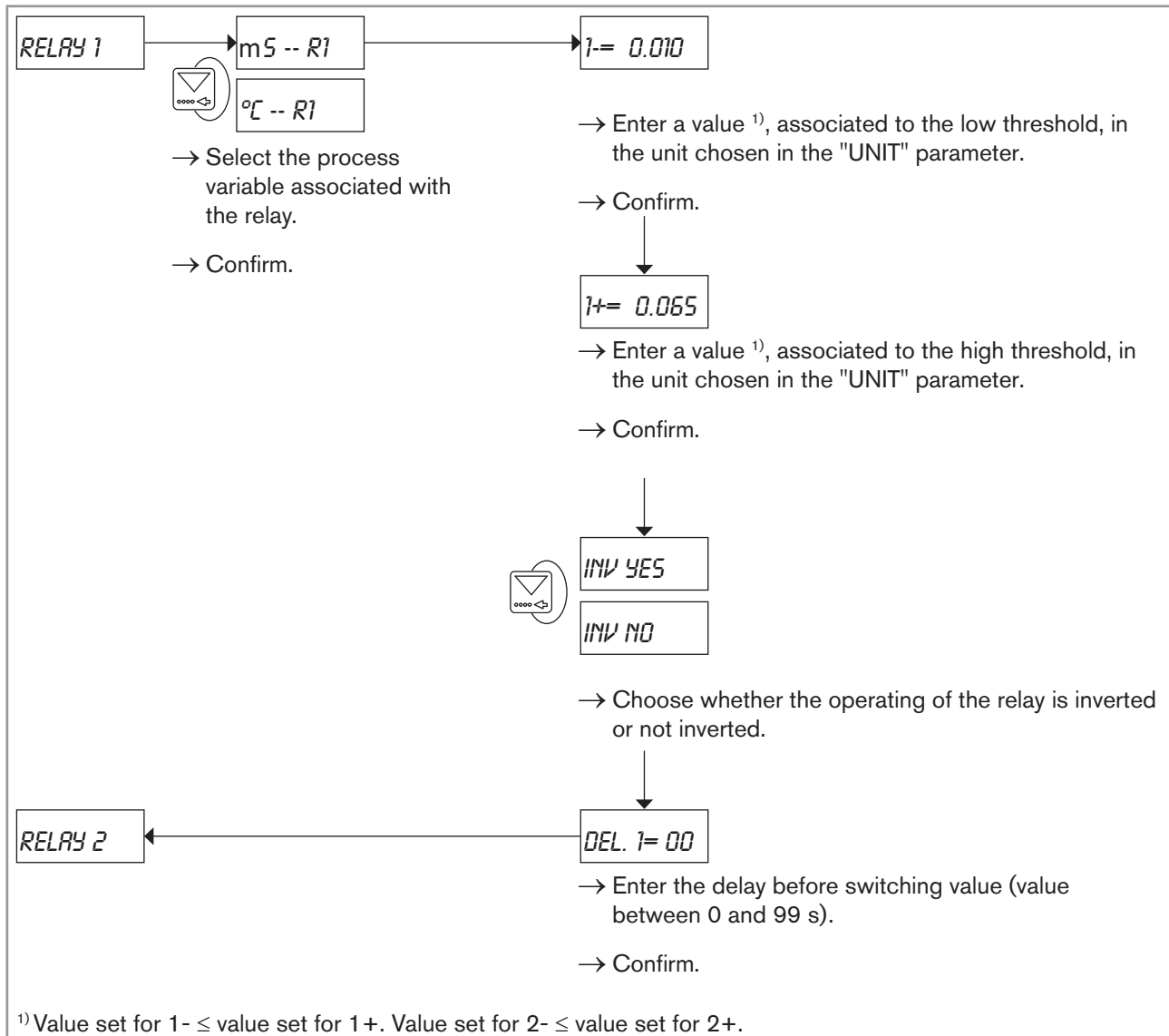


Figure 37 : Diagram for the setting of relay 1 (or relay 2) to switch a load depending on two thresholds

## Relay 2

Relay 2:

- makes it possible to switch a solenoid valve or a pump (depending on the set threshold values). In this case, the settings are similar to those made for relay 1: see [Figure 37](#) above.
- or can be configured as an alarm.



If relay 2 is used as an alarm, make sure that the open state of the relay corresponds to a safe position of the process.

The alarm is activated in the following situations:

- power supply problem ("PWR FAIL" is displayed): see chap. [9.3](#)
- measuring problem: the conductivity sensor is disconnected from the electronic board
- problem due to the measuring range of the temperature ( $-40\text{ °C} > T^\circ$  or  $T^\circ > 120\text{ °C}$ )

- problem due to the temperature sensor

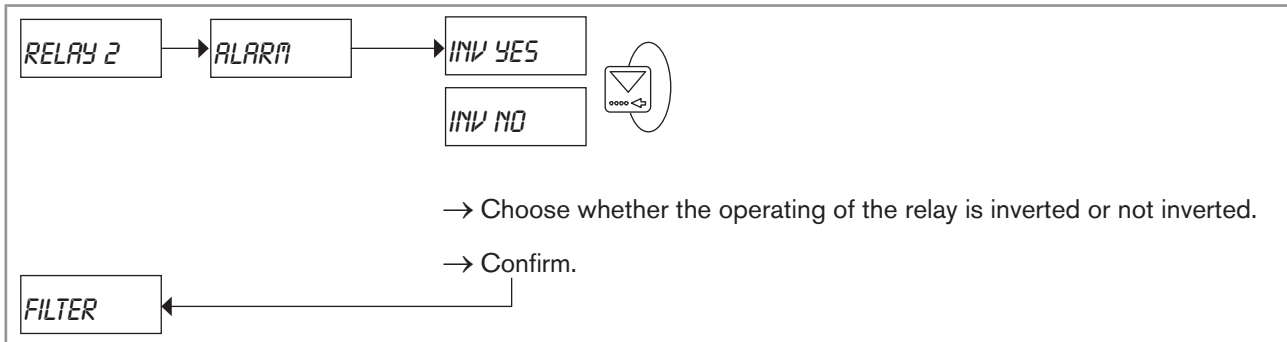


Figure 38 : Configuration of relay 2 as an alarm

→ If you do not want to adjust another parameter, go to the "END" parameter of the Parameters menu and press to save the settings and go back to the Process level.

### 8.7.8. Choosing a damping effect to prevent fluctuations

To access the parameter, see chap. 8.2.

The filter parameter provides an attenuation effect to prevent fluctuation within the output current (regardless of the associated measured quantity) and the display. Ten levels are available (0 to 9), level 0 providing no attenuation.

Filter 2 is appropriate for most applications.

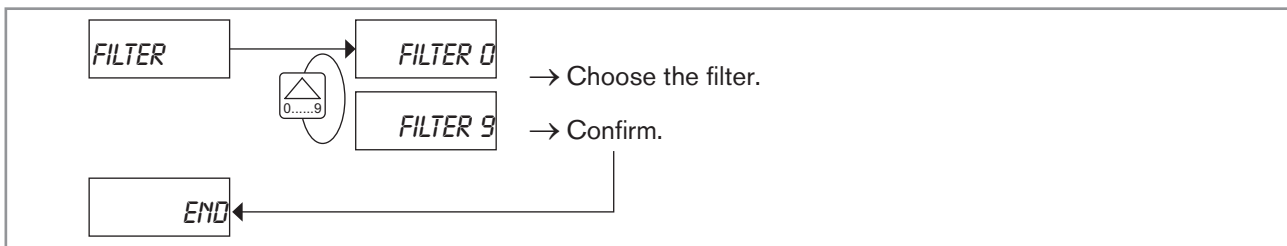


Figure 39 : Diagram of the "FILTER" parameter of the Parameters menu

The graphs below show the influence of some filters on the output current (associated with the conductivity measurement) and the display of the device.

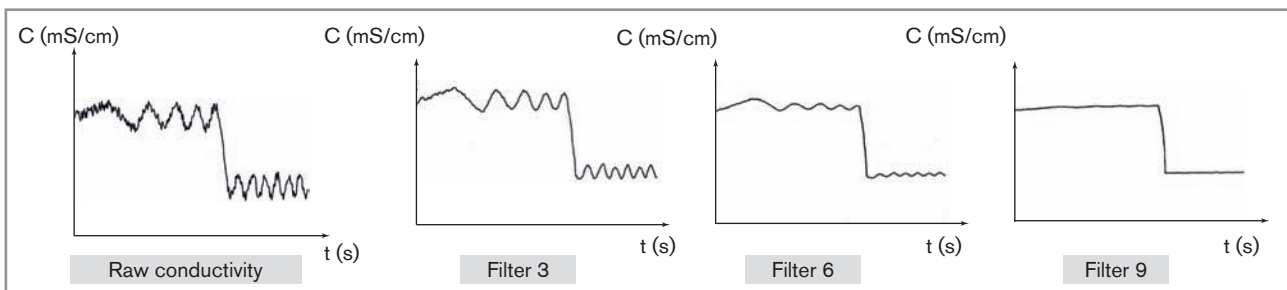





Figure 40 : Graphs showing the influence of some filters on the output current associated with the measurement of conductivity and the display of the device

→ If you do not want to adjust another parameter, go to the "END" parameter of the Parameters menu and press to save the settings and go back to the Process level.

MAN 1000189134 EN Version: A Status: RL (released | freigegeben) printed: 22.09.2017

## 8.8. Test menu

→ To access the Test menu from the Process level, simultaneously press   and  for 5 seconds.



The table below shows the paragraphs referring to each parameter of the Test menu:

| Parameter        | Function   | related chap.         |
|------------------|--|-----------------------|
| <b>OFFSET</b>    | To set the 4 mA current output.  | <a href="#">8.8.1</a> |
| <b>SPAN</b>      | To set the 20 mA current output.   | <a href="#">8.8.2</a> |
| <b>T° ADJUST</b> | To adjust the temperature to +/- 5°C or +/- 9°F.   | <a href="#">8.8.3</a> |
| <b>CONDUCT</b>   | To display the non-compensated conductivity.   | <a href="#">8.8.4</a> |
| <b>SIMUL</b>     | To check the behaviour of the current output and the relays, off fluid.  | <a href="#">8.8.5</a> |
| <b>CALIB.</b>    | To calibrate the zero point of conductivity.<br>This must be completed if air conductivity is >10µS/cm before installing the device.   | <a href="#">8.8.6</a> |
| <b>END</b>       | To go back to the Process level and save the new "OFFSET" and "SPAN" parameters set.<br><br>If one of the values is incorrect, you will automatically be redirected to the "OFFSET" parameter to enter new values. | -                     |

### 8.8.1. Adjusting the "OFFSET" for the output current

To access the parameter, see chap. [8.2](#).

Use this parameter to correct the basic setting of the 4 mA.

 To recalculate and save the new "OFFSET" and "SPAN" parameters, go to the "END" parameter of the Test menu and press .

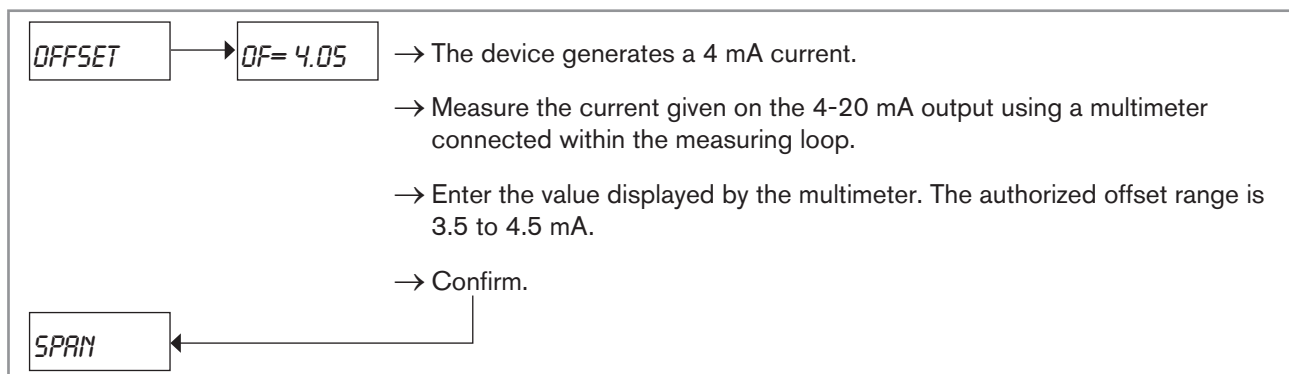


Figure 41 : Setting of the 4 mA



### 8.8.2. Adjusting the "SPAN" for the output current

To access the parameter, see chap. 8.2.

This function makes it possible to adjust the default 20 mA current value.

→ To recalculate and save the new "OFFSET" and "SPAN" parameters, go to the "END" parameter of the Test menu and press .

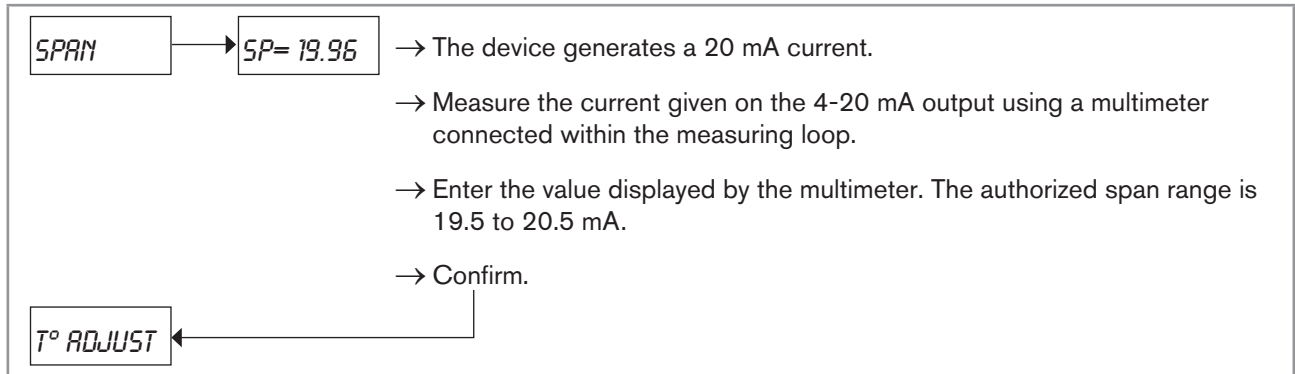


Figure 42 : Setting of the 20 mA

### 8.8.3. Adjusting the temperature

To access the parameter, see chap. 8.2.

The device is equipped with a conductivity sensor and a built-in digital temperature sensor. The value from the temperature sensor can be adjusted by an offset for compensation of the actual temperature gradients.

The chosen temperature will impact the value of the compensated conductivity.

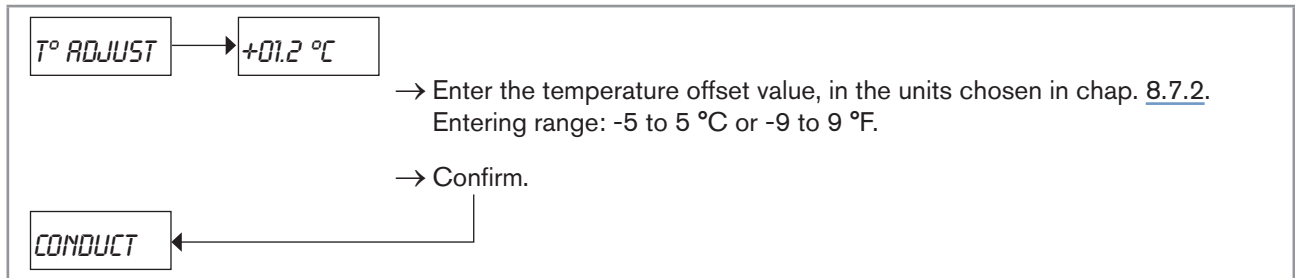


Figure 43 : Enter the value of the temperature offset in °C or in °F

→ If you do not want to adjust another parameter, go to the "END" parameter of the Test menu and press to save the settings and go back to the Process level.

### 8.8.4. Reading non-compensated conductivity

To access the parameter, see chap. 8.2.

Use this parameter to read a value of conductivity without any compensation, for verifying the actual conductivity.

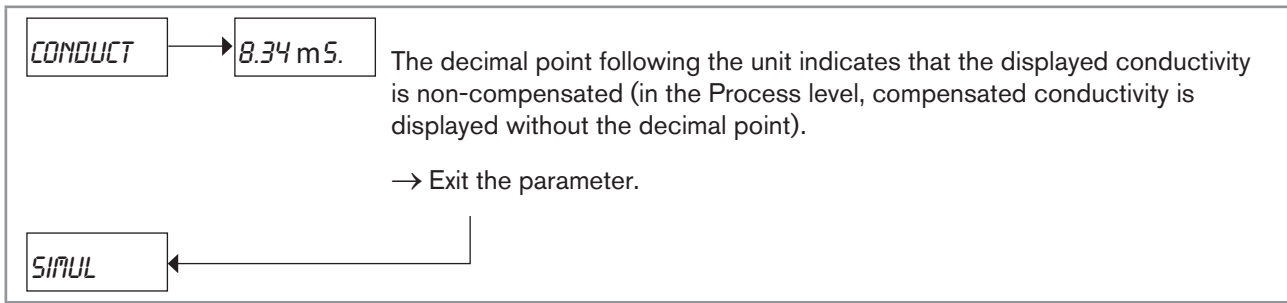




Figure 44 : Reading non-compensated conductivity

→ If you do not want to adjust another parameter, go to the "END" parameter of the Test menu and press  to save the settings and go back to the Process level.

### 8.8.5. Testing off-fluid the settings of the current output and the relays

To access the parameter, see chap. 8.2.

Use this parameter to simulate a conductivity or a temperature to test your installation without any liquid being present. The simulated value influences all the outputs, including the relays.

 First choose the units of conductivity and/or temperature as shown in chap. 8.7.2.

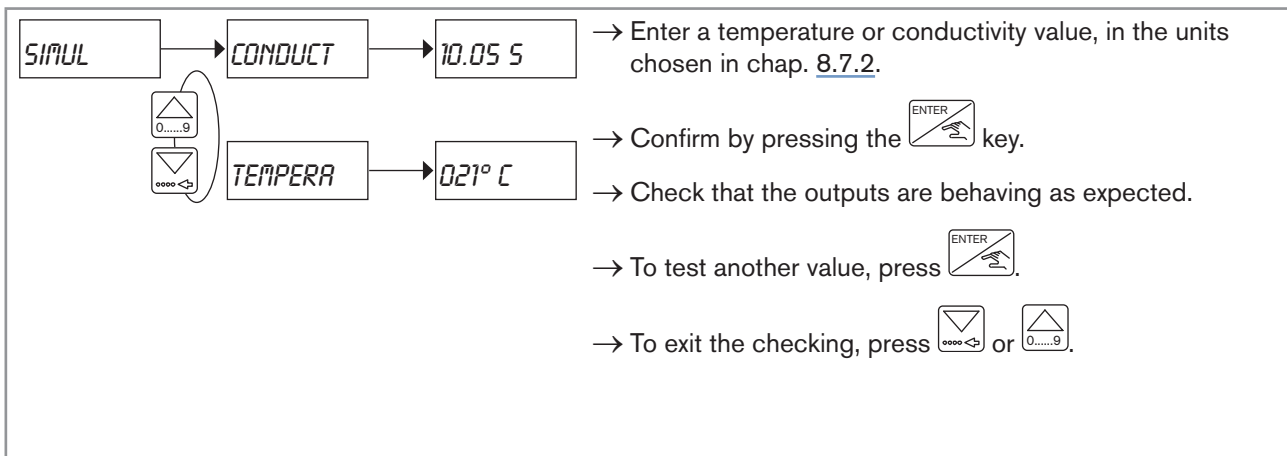



Figure 45 : Conductivity and temperature simulation in the "SIMUL" parameter

→ If you do not want to adjust another parameter, go to the "END" parameter of the Test menu and press  to save the settings and go back to the Process level.

### 8.8.6. Setting the zero point of conductivity

To access the parameter, see chap. 8.2.

If the value of air conductivity measured is higher than 10  $\mu\text{S}/\text{cm}$ , readjust the device, holding the sensor in the air (zero point of conductivity of the device).

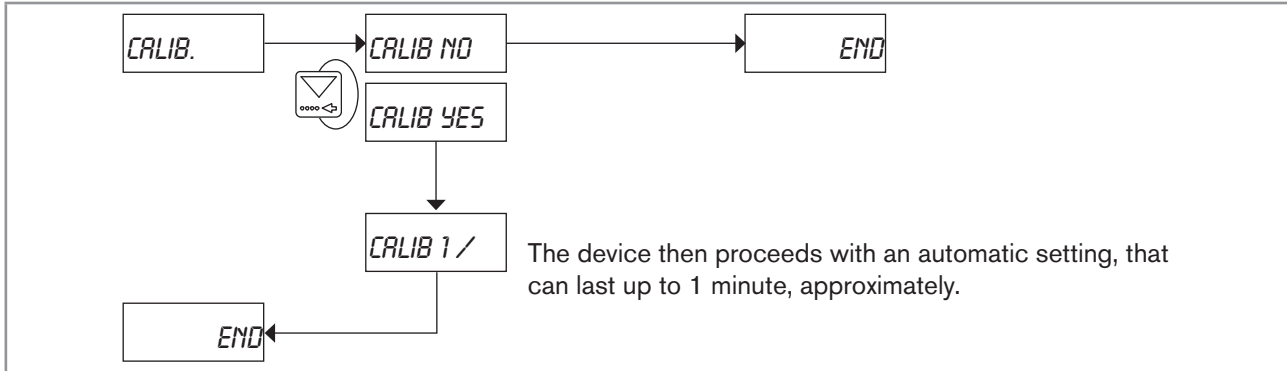


Figure 46 : Diagram of the "CALIB" parameter of the Test menu

→ If you do not want to adjust another parameter, go to the "END" parameter of the Test menu and press to save the settings and go back to the Process level.

### 8.9. Default settings of the device

|                             |                                 |
|-----------------------------|---------------------------------|
| Language                    | English                         |
| Unit of conductivity        | mS                              |
| Number of decimal positions | 2                               |
| Cell constant               | function of the cell            |
| ▪ Temperature compensation  | LINEAR                          |
| ▪ Coefficient               | TC = 0.00                       |
| Current                     | 4 mA: 00.00 mS, 20 mA: 00.00 mS |
| Relay 1-                    | 00.00 mS                        |
| Relay 1+                    | 00.00 mS                        |
| Relay 1 inverted            | NO                              |
| DEL1                        | 000                             |
| Relay 2-                    | 00.00 mS                        |
| Relay 2+                    | 00.00 mS                        |
| Relay 2 inverted            | NO                              |
| DEL2                        | 000                             |
| Filter                      | 2                               |

## 9. MAINTENANCE AND TROUBLESHOOTING

### 9.1. Safety instructions



#### **DANGER**

##### **Risk of injury due to high pressure in the installation.**

- Stop the circulation of fluid, cut off the pressure and drain the pipe before loosening the process connections.

##### **Risk of injury due to electrical voltage.**

- Shut down and isolate the electrical power source before carrying out work on the system.
- Observe all applicable accident protection and safety regulations for electrical equipment.

##### **Danger due to high temperatures of the fluid.**

- Use safety gloves to handle the device.
- Stop the circulation of fluid and drain the pipes before loosening the process connections.
- Keep all easily flammable material and fluid away from the device.

##### **Risk of injury due to the nature of the fluid.**

- Respect the prevailing rules on accident prevention and safety relating to the use of aggressive fluids.



#### **WARNING**

##### **Risk of injury due to non-conforming maintenance.**

- Maintenance must only be carried out by qualified and skilled staff with the appropriate tools.
- Ensure that the restart of the installation is controlled after any interventions.

### 9.2. Cleaning the device

If installation has been carried out properly and the operating conditions are correct, the device is maintenance-free. If need be, clean the device with a cloth dampened with a product that is compatible with the materials of the device. Please feel free to contact your Bürkert supplier for any additional information.



- Do not clog the hole of the conductivity sensor.
- Clean the conductivity sensor.
- Activate the HOLD mode (refer to chap. 8.6) to avoid interrupting the process while cleaning the device.

### 9.3. If you encounter problems

| Displayed message / Problem        | Current output | Relay 2 configured as an alarm | Possible cause   | What to do   |
|------------------------------------|----------------|--------------------------------|--|--|
| "PWR FAIL"<br>12-30 V DC version   | 22 mA          | activated                      | <ul style="list-style-type: none"> <li>▪ Power supply is unstable or lower than 12 V DC.</li> <li>▪ Power supply is defective.</li> </ul>  | <ul style="list-style-type: none"> <li>→ Use a supply voltage within the 12-30 V DC range.</li> <li>→ Use a filtered and stable power supply.</li> <li>→ If the problem persists, return the device to Bürkert.</li> </ul>   |
| "PWR FAIL"<br>115/230 V AC version | 22 mA          | activated                      | <ul style="list-style-type: none"> <li>▪ Power supply is unstable or lower than 115 V AC.</li> <li>▪ Power supply is defective.</li> </ul> | <ul style="list-style-type: none"> <li>→ Use a supply voltage of 115 or 230 V AC.</li> <li>→ If the problem persists, return the device to Bürkert.</li> </ul>   |
| "ERROR"                            | 22 mA          | activated                      | Internal memory error (EEPROM)   | <ul style="list-style-type: none"> <li>→ Switch the device off and on again.</li> <li>→ If the problem persists, return the device to Bürkert.</li> </ul>  |
| "--- °C"                           | 22 mA          | activated                      | Fluid temperature is out of range ( $-40\text{ °C} > T^{\circ}$ or $T^{\circ} > +120\text{ °C}$ ).   | <ul style="list-style-type: none"> <li>→ Check the temperature of the process.</li> <li>→ Replug the connectors of the conductivity sensor to the electronic board.</li> <li>→ If the problem persists, return the device to Bürkert.</li> </ul>   |
| "--- mS"                           | 22 mA          | activated                      | The black connector of the conductivity sensor is not plugged to the electronic board.   | <ul style="list-style-type: none"> <li>→ Replug the black connector of the conductivity sensor to the electronic board.</li> <li>→ If the problem persists, return the device to Bürkert.</li> </ul>   |
| "0000"                             | 4 to 20 mA     | idle                           | The value of conductivity is zero.   | <ul style="list-style-type: none"> <li>→ Check the coefficient of the sensor (should be 6 or 7). See chap. <a href="#">8.7.3</a> or <a href="#">8.7.4</a>.</li> <li>→ Replug the gold connector of the conductivity sensor to the electronic board.</li> <li>→ If the problem persists, return the device to Bürkert.</li> </ul> |

| Displayed message / Problem           | Current output | Relay 2 configured as an alarm | Possible cause  | What to do   |
|---------------------------------------|----------------|--------------------------------|---|--|
| "9999"                                | 4 to 20 mA     | idle                           | The measured value is beyond the maximum that can be displayed. | <ul style="list-style-type: none"> <li>→ Change the engineering unit (e.g.: change from mS to S). See chap. <a href="#">8.7.2</a>.</li> <li>→ Change the position of the decimal point (refer to chap. <a href="#">8.7.2</a>).</li> </ul>  |
| The value of conductivity is blinking | 22 mA          | activated                      | Fluid conductivity is out of range (>2 S).                      | <ul style="list-style-type: none"> <li>→ Check that conductivity is &lt;2 S.</li> <li>→ Check the coefficient of the sensor (should be 6 or 7). See chap. <a href="#">8.7.3</a> or <a href="#">8.7.4</a>.</li> <li>→ If the problem persists, return the device to Bürkert.</li> </ul> |

## 10. SPARE PARTS AND ACCESSORIES



### ATTENTION

**Risk of injury and/or damage caused by the use of unsuitable parts.**

Incorrect accessories may cause injuries and damage the device and the surrounding area.

- Use only original accessories and original replacement parts from Bürkert.

| Spare parts and accessories   | Order code | Legend<br>(Figure 47) |
|---|------------|-----------------------|
| Female connector EN 175301-803 with cable glands (type 2508)  | 438811     | 1                     |
| Female connector EN 175301-803 with NPT 1/2" reduction, without cable glands (type 2509) - UR and UL recognized   | 162673     | 2                     |
| Set comprising: <ul style="list-style-type: none"> <li>▪ 2 M20x1.5 cable glands</li> <li>▪ 2 neoprene flat seals for cable gland or plug</li> <li>▪ 2 screwed plugs M20x1.5</li> <li>▪ 2 multiway seals 2x6 mm</li> </ul>                         | 449755     | 3, 5, 6, 8            |
| Set comprising: <ul style="list-style-type: none"> <li>▪ 2 M20x1.5 / NPT 1/2" reductions (mounted o-ring)</li> <li>▪ 2 neopren flat seals for the screw plug</li> <li>▪ 2 screwed plugs M20x1.5</li> </ul>  | 551782     | 4, 5, 6               |
| Set comprising: <ul style="list-style-type: none"> <li>▪ 1 cable gland plug M20x1.5</li> <li>▪ 1 multiway seal 2x6 mm for cable gland</li> <li>▪ 1 black EPDM seal for the conductivity sensor</li> <li>▪ 1 mounting instruction sheet</li> </ul> | 551775     | 7, 8, 13              |
| PC housing with a female connector EN 175301-803 (type 2508), snap ring and nut   | 552400     | 9                     |
| PPA housing with female connector EN 175301-803 (type 2508), snap ring and nut  | 552401     | 9                     |
| PC housing for 2 cable glands M20x1.5, snap ring and nut  | 552398     | 10                    |
| PPA housing for 2 cable glands M20x1.5, snap ring and nut   | 552399     | 10                    |
| Snap ring   | 619205     | 11                    |
| PC nut  | 619204     | 12                    |
| PPA nut   | 440229     | 12                    |
| Set comprising: <ul style="list-style-type: none"> <li>▪ 1 green FKM seal (for the conductivity sensor)</li> <li>▪ 1 black EPDM seal ( for the conductivity sensor)</li> </ul>  | 552111     | 13                    |
| Certificate of 2 point calibration of the conductivity. You can: <ul style="list-style-type: none"> <li>▪ order one to be delivered with the device or</li> <li>▪ resend the device to Bürkert to obtain one.</li> </ul>                          | 550675     | -                     |

For better identification of the spare parts, refer to the figure below:

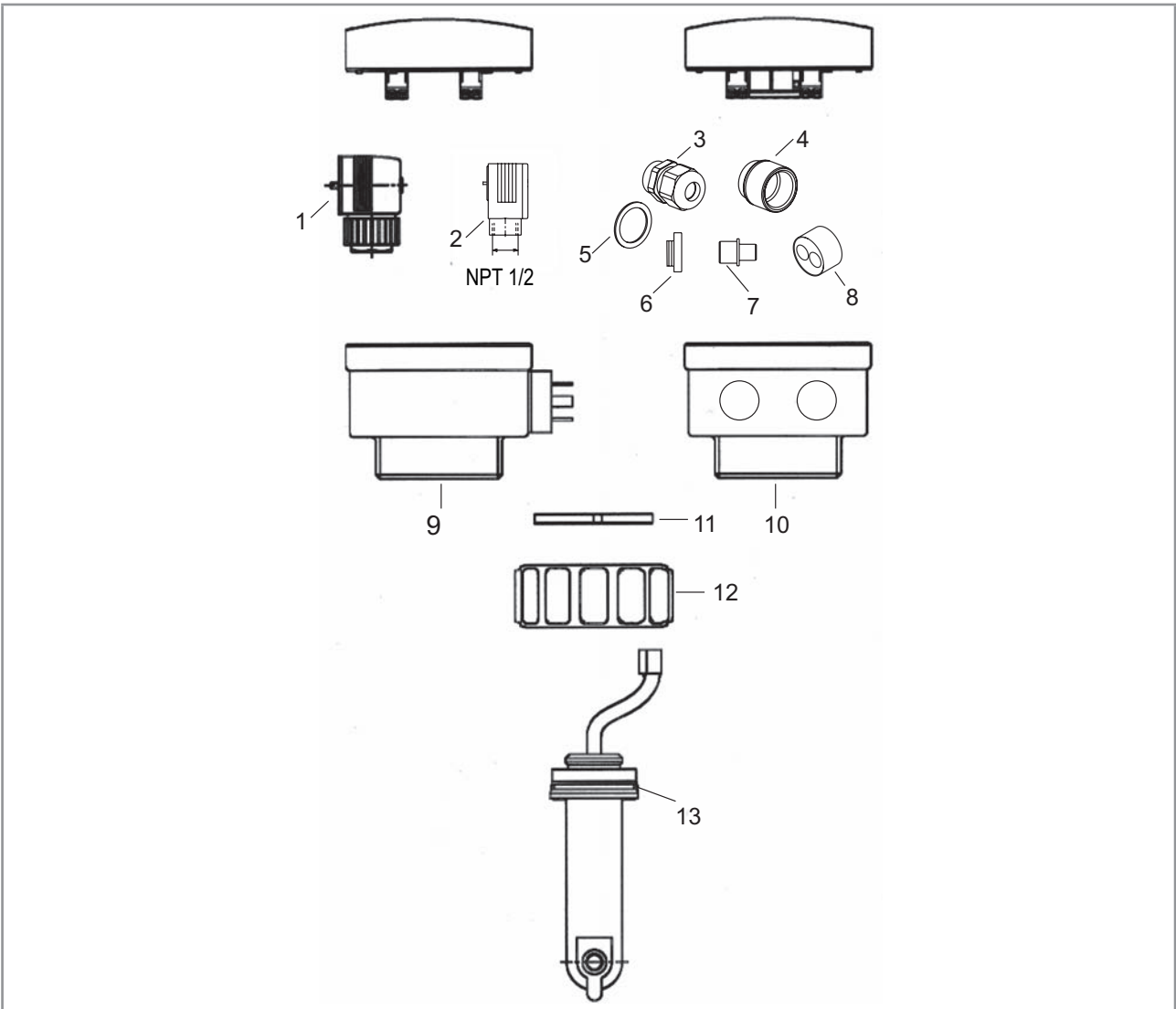


Figure 47 : Exploded view of the device



## 11. PACKAGING, TRANSPORT

### NOTE

#### Damage due to transport

Transport may damage an insufficiently protected device.

- Transport the device in shock-resistant packaging and away from humidity and dirt.
- Do not expose the device to temperatures that may exceed the admissible storage temperature range.
- Protect the electrical interfaces using protective plugs.

## 12. STORAGE

### NOTE

#### Poor storage can damage the device.

- Store the device in a dry place away from dust.
- Ambient storage temperature: -10 to + 60 °C.

## 13. DISPOSAL OF THE PRODUCT

→ Dispose of the device and its packaging in an environmentally-friendly way.

### NOTE

#### Damage to the environment caused by products contaminated by fluids.

- Keep to the existing provisions on the subject of waste disposal and environmental protection.



#### note

Comply with the national and/or local regulations which concern the area of waste disposal.





