

# Type 8098 FLOWave S

Durchflussmessgerät  
Flowmeter  
Débitmètre



## Quickstart

English    Deutsch    Français

We reserve the right to make technical changes without notice.  
Technische Änderungen vorbehalten.  
Sous réserve de modifications techniques.

© Bürkert Werke GmbH & Co. KG, 2019 - 2021

Operating Instructions 2111/04\_EU-ML\_00815331 / Original DE

<b>1</b>	<b>ABOUT THESE INSTRUCTIONS</b> .....	<b>4</b>	<b>7.3</b>	Recommendations for the installation into the pipe..	<b>18</b>
1.1	Symbols.....	4	7.4	Installing the device into the pipe.....	20
1.2	Definition of terms .....	4	<b>8</b>	<b>ELECTRICAL INSTALLATION</b> .....	<b>21</b>
<b>2</b>	<b>INTENDED USE</b> .....	<b>5</b>	8.1	Safety instructions.....	21
2.1	Device with ATEX/IECEEx approval.....	5	8.2	Requirements for electrical installation .....	22
<b>3</b>	<b>BASIC SAFETY INSTRUCTIONS</b> .....	<b>6</b>	8.3	Additional documentation .....	22
<b>4</b>	<b>GENERAL INFORMATION</b> .....	<b>7</b>	8.4	Connecting the device .....	22
4.1	Contact address.....	7	8.5	Connecting the protective earth.....	25
4.2	Warranty .....	7	<b>9</b>	<b>START-UP</b> .....	<b>25</b>
4.3	Information on the internet .....	7	9.1	Safety instructions.....	25
<b>5</b>	<b>STRUCTURE</b> .....	<b>8</b>	9.2	Setting with Bürkert Communicator .....	25
<b>6</b>	<b>TECHNICAL DATA</b> .....	<b>8</b>	9.3	büS .....	26
6.1	Operating conditions.....	8	<b>10</b>	<b>DISPLAY ELEMENTS</b> .....	<b>26</b>
6.2	Conformity.....	9	10.1	Status indicator .....	26
6.3	Standards and directives.....	9	10.2	NAMUR mode.....	26
6.4	EHEDG certification.....	9	<b>11</b>	<b>MAINTENANCE AND TROUBLESHOOTING</b> .....	<b>28</b>
6.5	Type label, adhesive label .....	10	11.1	Safety instructions.....	28
6.6	Type label lasered.....	11	11.2	Information on returning the device to the manufacturer	28
6.7	Certification markings .....	12	11.3	Cleaning the outer surface of the device .....	28
6.8	Marking of the Unique Serial Number (USN).....	12	11.4	Cleaning In Place (CIP) of the device .....	29
6.9	Fluid data.....	12	11.5	Sterilisation In Place (SIP) of the device.....	30
6.10	Measurement data .....	14	11.6	Troubleshooting.....	30
6.11	Electrical data.....	15	<b>12</b>	<b>ACCESSORIES</b> .....	<b>30</b>
6.12	Mechanical data .....	16	12.1	Communications software.....	31
<b>7</b>	<b>INSTALLATION</b> .....	<b>17</b>			
7.1	Safety instructions.....	17			
7.2	Preparatory work .....	17			

## 1 ABOUT THESE INSTRUCTIONS

The Quickstart contains extremely important information on the device.

→ Keep these instructions ready to hand at the operation site.



### Important safety information.

- ▶ Carefully read these instructions.
- ▶ Observe in particular the safety instructions, intended use and operating conditions.
- ▶ Persons, who work on the device, must read and understand these instructions.



The operating instructions can be found on the Internet at:

[www.burkert.com](http://www.burkert.com)

### 1.1 Symbols



#### DANGER!

##### Warns of an immediate danger.

- ▶ Failure to observe the warning may result in a fatal or serious injury.



#### WARNING!

##### Warns of a potentially dangerous situation.

- ▶ Failure to observe the warning may result in serious or fatal injuries.



#### CAUTION!

##### Warns of a possible danger.

- ▶ Failure to observe the warning may result in moderate or minor injuries.

#### ATTENTION!

##### Warns of damage to property.

- ▶ Failure to observe the warning may result in damage to the device or system.



Indicates important additional information, tips and recommendations.



Refers to information in these instructions or in other documentation.

- ▶ Designates an instruction to prevent risks.

→ designates a procedure that must be carried out.

- ✔ Indicates a result.

### 1.2 Definition of terms

In these instructions the term “device” denotes the following device type: flowmeter Type 8098 FLOWave S.

The term “büS” (Bürkert system bus) used in this instruction stands for the communication bus developed by Bürkert and based on the CANopen protocol.

## 2 INTENDED USE

The Type 8098 FLOWave S flowmeter uses the Surface Acoustic Wave (SAW) measurement principle and is intended to measure the flow rate of liquids that have all of the following characteristics:

- clean liquids
  - non emulsified liquids (homogeneous liquids)
  - liquids that are free of air bubbles
  - liquids that are free of gas bubbles
  - liquids that are free of solids.
- ▶ Use the device for its intended purpose only. Non-intended use of the device may be dangerous to people, nearby equipment and the environment.
- ▶ Correct transportation, correct storage as well as correct installation, commissioning, operation and maintenance are essential for reliable and problem-free operation.
- ▶ When using the device, observe the permitted data, operating conditions and application conditions. This information can be found in the contractual documents, the operating instructions and on the type label.
- ▶ Use the device only in conjunction with third-party devices and components recommended and authorized by Bürkert.
- ▶ Do not use the device outdoors without protection from the weather.
- ▶ Protect the device against electromagnetic interference, ultra-violet rays.
- ▶ Do not use the device without ATEX/IECEx approval in a potentially explosive atmosphere.

### 2.1 Device with ATEX/IECEx approval



#### **DANGER!**

**Risk of explosion in the event of improper use of the device in potentially explosive atmospheres.**

- ▶ Observe the specifications of the ATEX/IECEx-conformity certificate.
- ▶ Observe the specifications given in the ATEX/IECEx supplement for Type 8098 FLOWave S. The supplement is available at [www.burkert.com](http://www.burkert.com)

The ATEX/IECEx approval is only valid if the device is used as described in the ATEX/IECEx supplement.

If unauthorized changes are made to the device, then the ATEX/IECEx approval becomes invalid.

### 3 BASIC SAFETY INSTRUCTIONS

These safety instructions do not consider any contingencies or incidents which occur during installation, operation and maintenance. The operator is responsible for observing the location-specific safety regulations, also with reference to the personnel.

#### **DANGER!**

##### **Risk of injury from high pressure and discharge of medium.**

- ▶ Before working on the device or system, switch off the pressure. Vent or drain lines.
- ▶ Respect the regulations to the use of dangerous fluids.

##### **Risk of injury from electric shock.**

- ▶ Before working on the device or system, switch off the power supply. Secure against reactivation.
- ▶ Observe applicable accident prevention and safety regulations for electrical equipment.

##### **Risk of burns und risk of fire through hot device surface at high liquid temperatures.**

- ▶ Use safety gloves to handle the device.
- ▶ Keep the device away from highly flammable substances and media.

#### **CAUTION!**

##### **Risk of injury due to a heavy device.**

A heavy device can fall down during transport or during installation and cause injuries.

- ▶ Transport, install and dismantle a heavy device with the help of another person.
- ▶ Use appropriate tools.

##### **To prevent injury, ensure the following:**

- ▶ Secure device or system to prevent unintentional activation.
- ▶ Only trained technicians may perform installation and maintenance work.
- ▶ Perform installation and maintenance with suitable tools only.
- ▶ Do not make any changes to the device and do not subject it to mechanical stress.
- ▶ Operate the device only in perfect state and in consideration of the operating instructions.
- ▶ Observe the general rules of technology.
- ▶ Install the device according to the regulations applicable in the respective country.
- ▶ Do not use the device for measuring the flow of gas or steam.
- ▶ After the process is interrupted, restart in a controlled manner. Observe sequence:
  1. Connect electrical power supply.
  2. Charge the device with medium.
- ▶ Observe intended use.

## ATTENTION!

### Electrostatic sensitive components or modules.

The device contains electronic components which react sensitively to electrostatic discharge (ESD). Contact with electrostatically charged persons or objects is hazardous to these components. In the worst case scenario, they will be destroyed immediately or will fail after start-up.

- ▶ Observe the requirements in accordance with EN 61340-5-1 to minimize or avoid the possibility of damage caused by sudden electrostatic discharge.
- ▶ Also ensure that you do not touch electronic components when the power supply voltage is present.

### Damage to the device caused by the wrong medium.

- ▶ Check the chemical compatibility of the materials in contact with the medium.

## 4 GENERAL INFORMATION

### 4.1 Contact address

#### Germany

Bürkert SAS  
Rue du Giessen  
BP 21  
F-67220 TRIEMBACH-AU-VAL

#### International

Contact addresses can be found on the final pages of the printed operating instructions.

And also on the Internet at:

[www.burkert.com](http://www.burkert.com)

### 4.2 Warranty

The warranty is only valid if the device is used as intended in accordance with the specified application conditions.

### 4.3 Information on the internet

The operating instructions and data sheets for Type 8098 can be found on the Internet at:

[www.burkert.com](http://www.burkert.com)

## 5 STRUCTURE

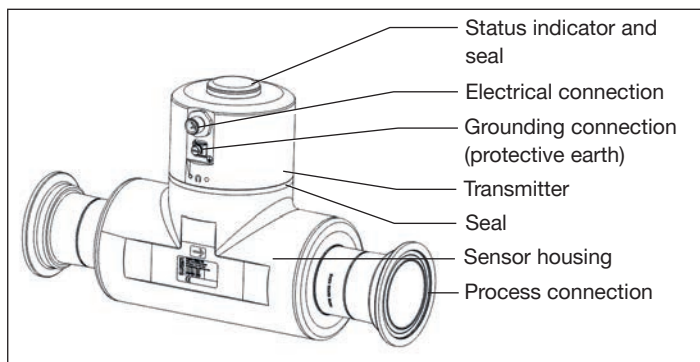

Fig. 1: Structure

The flowmeter Type 8098 FLOWave S is made up of a transmitter Type SE91 and a flow sensor Type S097.

The device is delivered with a magnetic key to unlock the transmitter.



Fig. 2: Unlocking magnetic key

### Variants of the transmitter:

- Without outputs
- With 2 outputs that can be configured as analogue or digital outputs

## 6 TECHNICAL DATA

### 6.1 Operating conditions

Ambient temperature	-10 – +70 °C
Air humidity	< 85%, non condensing
Operating altitude	Up to 2000 m above sea level
Operating mode	Continuous operation
Device mobility	Fixed device
Use	Indoor and outdoor (with protection against electromagnetic interference, ultraviolet rays and weather conditions)
Installation category	Category I according to UL/ EN 61010-1
Degree of pollution	Degree 2 according to UL/ EN 61010-1
Degree of protection according to IEC/EN 60529	IP65/IP67 <sup>1)</sup>
according to NEMA250	4X <sup>1)</sup>

1) If the device is wired and the transmitter is closed.  
Not evaluated by UL.



## 6.2 Conformity

In accordance with the EU Declaration of conformity, the device is compliant with the EU Directives.

## 6.3 Standards and directives

The applied standards, which verify conformity with the EU Directives, can be found on the EU-Type Examination Certificate and / or the EU Declaration of Conformity.

### 6.3.1 Conformity to the Pressure Equipment Directive

The device conforms to Article 4, Paragraph 1 of the Pressure Equipment Directive 2014/68/EU under the following conditions:

Device used on a pipe (PS = maximum admissible pressure in bar; DN = nominal diameter of the pipe)



Type of fluid	Conditions
Fluid group 1, Article 4, Paragraph 1.c.i	DN ≤ 25
Fluid group 2, Article 4, Paragraph 1.c.i	DN ≤ 32 or PSxDN ≤ 1000 bar
Fluid group 1, Article 4, Paragraph 1.c.ii	DN ≤ 25 or PSxDN ≤ 2000 bar
Fluid group 2, Article 4, Paragraph 1.c.ii	DN ≤ 200 or PS ≤ 10 bar or PSxDN ≤ 5000 bar

Tab. 1: Pressure Equipment Directive

### 6.3.2 UL certification

The devices with variable key PU01 or PU02 are UL-certified devices and comply with the following standards:

- UL 61010-1
- CAN/CSA-C22.2 n°61010-1

Identification on the device	Certification	Variable key
	UL recognized	PU01
	UL listed	PU02

Tab. 2: UL certification

### 6.4 EHEDG certification

- EL class I
- The following versions are EHEDG certified:

Process connections	Diameters
Clamp <sup>2)</sup> connections according to ASME BPE (DIN 32676 series C)	3/8", 1/2", 3/4", 1", 1 1/2", 2", 2.5", 3"
Clamp connections according to DIN 11864-3 series C	1/2", 3/4", 1", 1 1/2", 2"
Flange connections according to DIN 11864-2 series C	1/2", 3/4", 1", 1 1/2", 2"

Process connections	Diameters
Clamp <sup>2)</sup> connections according to DIN 32676 series B	DN08, DN15 (except variants with a clamp diameter of 34.0 mm) DN25, DN40, DN50, DN65, DN80
Clamp <sup>2)</sup> connections according to DIN 32676 series A	DN10, DN15, DN25, DN40, DN50, DN65, DN80
Clamp connections according to DIN 11864-3 series A, DIN 11864-3 series B	DN08, DN15, DN25, DN40, DN50
Clamp <sup>2)</sup> connections according to SMS 3017 / ISO 2852 for pipes according to SMS 3008	DN25, DN40, DN50
Flange connections according to DIN 11864-2 series A, DIN 11864-2 series B	DN08, DN15, DN25, DN40, DN50
Threaded <sup>3)</sup> connections according to DIN 11851 series A	DN65, DN80

Tab. 3: EHEDG certification

- 2) The EHEDG compliance is only valid if used in combination with EHEDG-compliant gaskets from Combifit International B.V.
- 3) The EHEDG compliance is only valid if used in combination with EHEDG-compliant gaskets from:  
Kieselmann GmbH, Germany (ASEPTO-STAR k-flex upgrade gaskets) or  
Siersema Componenten Service (S.K.S.) B.V. (Netherlands SKS gaskets set DIN 11851 EHEDG with EPDM or FKM inner gasket)

## 6.5 Type label, adhesive label

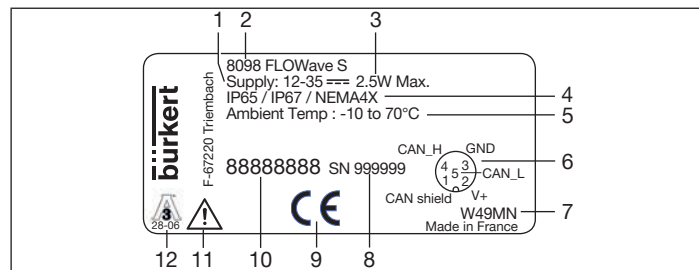

Fig. 3: Type label flowmeter (example)

1. Operating voltage
2. Type
3. Power consumption
4. Degree of protection
5. Ambient temperature
6. Pin assignment of the M12 male connector
7. Manufacture code
8. Serial number
9. CE marking
10. Order number
11. Warning: Before using the device, take into account the technical specifications given in the Operating Instructions.
12. Certification

## Type 8098

### Technical data

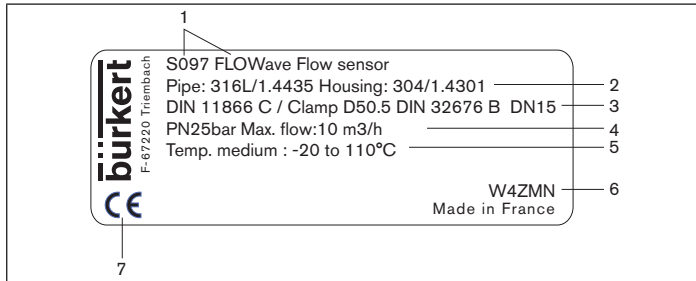

Fig. 4: Type label flow sensor (example)

1. Type
2. Material of the pipe and material of the housing
3. Standard the pipe conforms to type and standard of the process connection conforms to DN of the measurement tube
4. Pressure class of the device and maximum flow rate
5. Fluid temperature range
6. Manufacture code
7. CE marking

## 6.6 Type label lasered

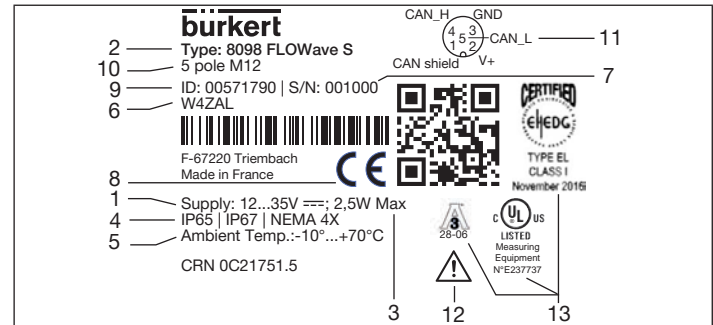

Fig. 5: Type label flowmeter (example)

1. Operating voltage
2. Type
3. Power consumption
4. Degree of protection
5. Ambient temperature
6. Manufacture code
7. Serial number
8. CE marking
9. Order number
10. Male connector
11. Pin assignment of the M12 male connector
12. Warning: Before using the device, take into account the technical specifications given in the operating instructions.
13. Certification

- |   |   |  |
|---|---|--|
| 1   | — | Type: S097 FLOWave Flow Sensor                 |
| 6   | — | WXXXX  |
|  |   |  |
| 2   | — | Pipe: 316L/1.4435   Housing: 304/1.4301        |
| 3   | — | DIN 11866 C / Clamp D50.5 DIN 32676 C DN1 1/2" |
| 4   | — | PN 25bar   Max Flow: 35m³/h                    |
| 5   | — | Medium Temp: -20°C...110°C                     |

Fig. 6: Type label flow sensor (example)

1. Type
2. Material of the pipe and material of the housing
3. Standard the pipe conforms to type and standard of the process connection conforms to DN of the measurement tube
4. Pressure class of the device and maximum flow rate
5. Fluid temperature range
6. Manufacture code
7. CE marking

## 6.7 Certification markings

Certification markings are either located on the Type label of the device or on separate labels.

## 6.8 Marking of the Unique Serial Number (USN)

The USN is marked on the side of the sensor. The USN is built with the order number and the serial number of the device.

## 6.9 Fluid data

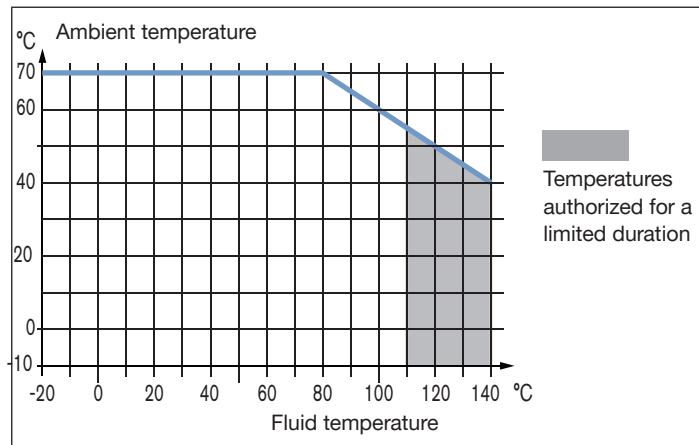

Fig. 7: Dependency between the fluid temperature and the ambient temperature

Fluid temperature -20 – +110 °C, with clamp process connections. Up to 140 °C for maximum 60 minutes for a sterilisation process. Maximum temperature gradient: 10 °C/s. The maximum fluid temperature can be restricted by the ambient operating temperature. Depending on the version of your device, see “Fig. 7”

Type of fluids Non-dangerous liquids according to Article 4, Paragraph 1 of Directive 2014/68/EU

## Type 8098

Technical data

Speed of sound in the fluid

DN08, 3/8", 1/2"	1000 – 2000 m/s
≥ DN15, ≥ 3/4"	800 – 2300 m/s

Process connection			
Size	Type	Standards	PN
DN08, DN10, DN15, DN25	clamp	DIN 11864-3 series B DIN 32676 series A DIN 32676 series B	PN25
	flange	DIN 11864-2 series B	PN25
DN15, DN25	clamp	DIN 11864-3 series A	PN25
	flange	DIN 11864-2 series A	PN25
DN25	clamp	SMS 3017 / ISO 2852 for pipes according to SMS 3008	PN25
3/8", 1/2", 3/4", 1", 1 1/2"	clamp	ASME BPE (DIN 32676 series C)	PN25
1/2", 3/4", 1", 1 1/2"	clamp	DIN 11864-3 series C	PN25
	flange	DIN 11864-2 series C	PN25
DN40	clamp	DIN 11864-3 series B DIN 32676 series B	PN16
		DIN 11864-3 series A DIN 32676 series A SMS 3017 / ISO 2852 for pipes according to SMS 3008	PN25
		DIN 11864-2 series B	PN16
	flange	DIN 11864-2 series A	PN25

Process connection			
Size	Type	Standards	PN
DN50	clamp	DIN 11864-3 series A DIN 11864-3 series B DIN 32676 series A DIN 32676 series B SMS 3017 / ISO 2852 for pipes according to SMS 3008	PN16
	flange	DIN 11864-2 series A DIN 11864-2 series B	PN16
2"	clamp	ASME BPE (DIN 32676 series C) DIN 11864-3 series C	PN16
	flange	DIN 11864-2 series C	PN16
DN65, DN80	clamp	DIN 32676 series A DIN 32676 series B	PN10
	threaded	DIN 11851 series A	PN10
ASME 2 1/2", 3"	clamp	DIN 32676 series C	PN10

Tab. 4: Fluid pressure, depending on the pipe diameter, the type of process connections and the process connection standard

## 6.10 Measurement data

### Flow rate measurement

Measurement range	0 – 1.7 m <sup>3</sup> /h to 0 – 200 m <sup>3</sup> /h, depending on the DN of the sensor
Measurement deviation <sup>4) 5)</sup> for a flow rate between 10 % of the full scale and the full scale	±0.4 % of the measured value
Measurement deviation <sup>4) 5)</sup> for a flow rate between 1 % of the full scale and 10 % of the full scale	< ±0.08 % of the full scale
Repeatability <sup>5)</sup> for a flow rate between 10 % of the full scale and the full scale	±0.2 % of the measured value
Repeatability <sup>5)</sup> for a flow rate between 1 % of the full scale and 10 % of the full scale	±0.04 % of the full scale
Refresh time	Adjustable (Bürkert Communicator)

### Temperature measurement

Measurement range	-30 – +140 °C
Measurement deviation <sup>4)</sup> for temperatures up to 100 °C	±1 °C
Measurement deviation <sup>4)</sup> for temperatures between 100 °C and 140 °C	±1.5 %
Refresh time	1 s

### Density factor measurement (optional feature)

Measurement range	0.8 – 1.3
Resolution	0.00001
Repeatability	±0.5 % of the measured value
Refresh time	Adjustable (Bürkert Communicator)

### Acoustic transmission factor measurement (optional feature)

Measurement range	10 – 120 %
Resolution	0.01 %
Repeatability	±2 % of the measured value
Refresh time	Adjustable (Bürkert Communicator)

- 4) "Measurement bias" as defined in standard JCGM 200:2012.  
 5) Determined under the following reference conditions: fluid = water, free of gas bubbles and solids; water and ambient temperatures = 23 °C ±1 °C (73.4 °F ±1.8 °F), device settings with their default values, short refresh time, while maintaining turbulent or laminar flow, applying the minimum inlet (40xDN) and minimum outlet (1xDN) straight pipe lengths, appropriate pipe dimensions.

## 6.11 Electrical data

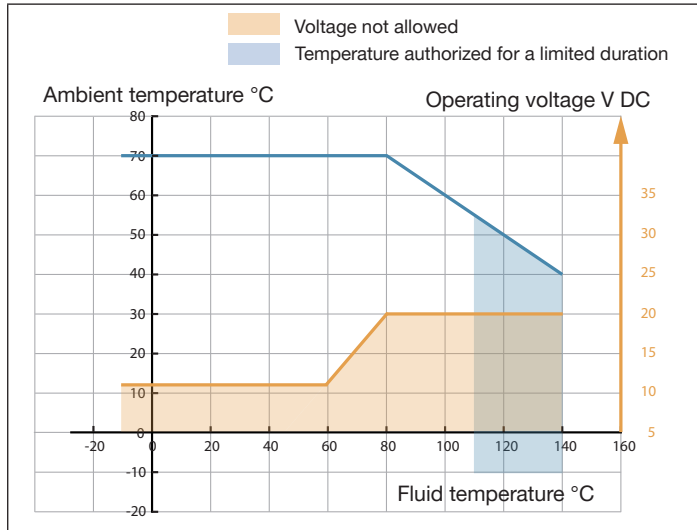

Fig. 8: Minimum supply voltage depending on the ambient temperature and the fluid temperature

Connections	Circular plug-in connector
without outputs	M12 x 1, 5-pin
with outputs	M12 x 1, 8-pin
Operating voltage	12 – 35 V DC $\pm$ 10 %
	the minimum supply voltage depends on the fluid temperature and the ambient operating temperature: see “Fig. 8”

Filtered and regulated  
Extra-Low Voltage circuit (SELV circuit)  
Limited Power Source (LPS) according to standards UL/EN 60950-1 or through a limited-energy circuit according to standards UL/EN 61010-1

Current consumption	max. 1 A
Power consumption	
without outputs	$\leq$ 2.5 W
with outputs	$\leq$ 5 W
Polarity reversal	Protected
Outputs (variant)	Configurable as analogue output or digital output
Analogue output	
	4 – 20 mA current
	3.6 mA or 22 mA to indicate an error
	Uncertainty: $\pm$ 0.04 mA
	Resolution: 0.8 $\mu$ A
	Open loop detection (diagnostics software function)
	Sink or source mode
	Galvanically isolated, passive
	Protected against polarity reversal
	Maximum loop impedance 1300 W at 35 V DC, 1000 W at 30 V DC, 700 W at 24 V DC, 450 W at 18 V DC
Digital output	
	Transistor
	NPN or PNP mode
	Mode: pulse, on/off, threshold, frequency (configurable)

0 – 2000 Hz, 5 – 35 V DC, max. 700 mA  
Galvanically isolated, passive  
Overload information (diagnostics software function)  
Protected against overloads and polarity reversals

**Communications interface**

Connection to PC via USB-büS interface (see accessories)  
The büS connection of the variant with outputs is only for connection to the Bürkert Communicator for configuration and software updating of the device. Due to the lack of CAN shielding, conventional büS/ CANopen communication is not recommended.

**Communication software**

Bürkert Communicator

**6.12 Mechanical data**

Dimensions and weight see data sheet

**Materials**

Transmitter housing<sup>6)</sup> Stainless steel 304 / 1.4301, outer surface finish Ra < 1.6 µm  
Sensor body Stainless steel 304 / 1.4301, outer surface finish Ra < 1.6 µm  
Stainless steel 316L / 1.4435, outer surface finish Ra < 1.6 µm

5-pin M12 male connector	Stainless steel
Blind plug	Stainless steel
Seals	
Sensor/transmitter	Silicone
Transmitter/status indicator	EPDM
Type label (adhesive labels)	Polyester
Sensor measurement tube <sup>7)</sup>	Stainless steel 316L / DIN 1.4435 <sup>8)</sup>
Line connections <sup>7)</sup>	Stainless steel 316L / DIN 1.4435 <sup>9)</sup>
Surface finish according to ISO 4288	
Measurement tube inner surface	Ra < 0.8 µm (30 µin) or Ra < 0.4 µm (15 µin) electro-polished
outer surface	Ra < 1.6 µm <sup>9)</sup>
Sensor body	Ra < 1.6 µm <sup>9)</sup>

6) The housing may have slight machining marks due to the manufacturing process. These marks do not affect the operation of the device and are not a manufacturing defect.

7) In contact with the fluid

8) with low delta-ferrite rate

9) excluding welding seams



## 7 INSTALLATION

### 7.1 Safety instructions



#### **DANGER!**

##### **Risk of injury from high pressure in the equipment/device.**

- ▶ Before working on equipment or device, switch off the pressure and deaerate/drain lines.
- ▶ Respect the regulations to the use of dangerous fluids.

##### **Risk of injury from electric shock.**

- ▶ Before working on the device or system, switch off the power supply. Secure against reactivation.
- ▶ Observe applicable accident prevention and safety regulations for electrical equipment.

##### **Risk of burns and risk of fire through hot device surface.**

- ▶ Use safety gloves to handle the device.
- ▶ Keep the device away from highly flammable substances and media.



#### **WARNING!**

##### **Risk of injury from improper installation.**

- ▶ Installation may be carried out by authorized technicians only and with the appropriate tools.

##### **Risk of injury from unintentional activation of the system and an uncontrolled restart.**

- ▶ Secure system from unintentional activation.
- ▶ Following assembly, ensure a controlled restart.



#### **CAUTION!**

##### **Risk of injury due to a heavy device.**

A heavy device can fall down during transport or during installation and cause injuries.

- ▶ Transport, install and dismantle a heavy device with the help of another person.
- ▶ Use appropriate tools.

### 7.2 Preparatory work

Before installing the device into the pipe, you may change the position of the transmitter on the sensor.

#### 7.2.1 Changing the position of the transmitter on the sensor

The Type SE91 transmitter can have four positions on the Type S097 flow sensor.

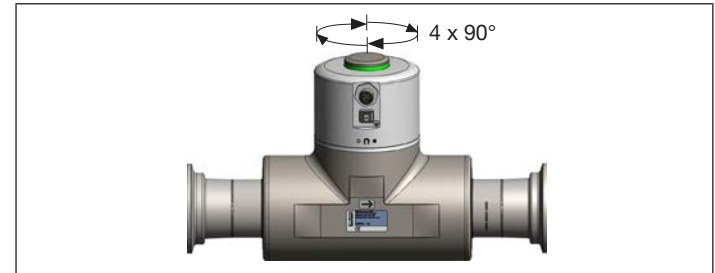





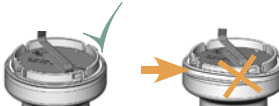

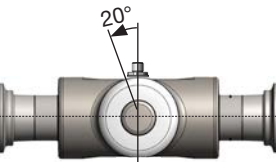
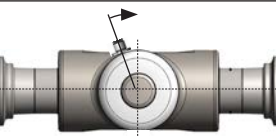

Fig. 9: Positions of the transmitter SE91

**Change the position:**

 <p>The transmitter is locked</p> <p>The transmitter is unlocked</p> <p>Magnetic key</p>	<p>For safety reasons and to comply with standard UL 61010-1, the transmitter and the flow sensor are locked.</p> <p>→ Put the magnetic key on the  mark.</p> <p>→ While the magnetic key is on the  mark, turn the transmitter by hand only from the locked position to the unlocked position.</p>
	<p>→ Hold the flow sensor with one hand and, with the other hand, turn the transmitter by about 20 degrees counterclockwise.</p> <p>→  Lift the transmitter carefully because a cable connects the transmitter to the flow sensor.</p>
	<p>→ If the seal is damaged, replace it. Apply a layer of lithium soap grease to the new seal before you put it in place.</p> <p>→ If the seal is not located in the groove, put it back in the groove.</p>

	<p>→ Turn the transmitter to the desired position.</p> <p>→  Make sure the cable stays inside the transmitter.</p>
	<p>→ Turn the transmitter by about 20 degrees counterclockwise.</p> <p>→ Place the transmitter on the flow sensor.</p>
	<p>→ Screw the transmitter clockwise on the flow sensor until the transmitter is parallel or perpendicular to the axis of the pipe.</p>

**7.3 Recommendations for the installation into the pipe**

- Protect this device against electromagnetic interference, ultraviolet rays and, when installed outdoors, the effects of climatic conditions.
- Make sure the DN of the measurement tube is suited to the flow velocity: refer to the data sheet of the device, available at [www.burkert.com](http://www.burkert.com).
- Choose a location with enough free space to put the magnetic key on the symbol at the side of the device.

- For heavy devices or long pipes, support the device and pipes.
- Transport and install a heavy device with the help of another person and suitable tools.
- If the temperature of the liquid is subject to fluctuations, ensure that the device can expand.
- Install the device upstream a valve or any equipment that changes the pipe diameter or the pipe direction.

Under reference conditions i.e. measuring fluid = water free from gas bubbles and solids, ambient and water temperature =  $23\text{ °C} \pm 1\text{ °C}$  ( $73.4\text{ °F} \pm 1.8\text{ F}$ ), and short refresh time, while maintaining turbulent or laminar flow profile, with the minimum inlet ( $40 \times \text{DN}$ ) and outlet ( $1 \times \text{DN}$ ) distances and the appropriate internal diameter of the pipes. Deviation from reference conditions can be adjusted through the use of a built-in correction K factor adjustment or Teach-in procedure.

- Install the device into either horizontal, oblique or vertical pipes. But an installation in a vertical pipe will be better to prevent air or gas bubbles inside the measurement area.
- For proper operation always ensure a totally filled measurement tube.
- To allow proper self-draining and to respect the 3A and EHEDG requirements, install the device into a pipe with a minimum angle against the horizontal. See “[Tab. 5](#)”.

Process connection		Angle against the horizontal
Type	Standards	
clamp	DIN 32676 series A DIN 11864-3 series A SMS 3017 / ISO 2852 for pipes according to SMS 3008	DN15 to DN50: minimum 5° DN65 and DN80: minimum 3°
	flange	DIN 11864-2 series A
clamp	ASME BPE (DIN 32676 series C) DIN 32676 series B DIN 11864-3 series B DIN 11864-3 series C	minimum 3°
flange	DIN 11864-2 series B DIN 11864-2 series C	minimum 3°
threaded	DIN 11851 series A	minimum 3°

Tab. 5: Minimum angle against the horizontal for proper self-draining

- If the pipe is fitted with a thermal insulation, do not thermally insulate the measurement tube of the device to make sure that the temperature in the device is less than  $70\text{ °C}$ . Refer to “[Fig. 10](#)” and “[Fig. 15](#)” for the minimum supply voltage.

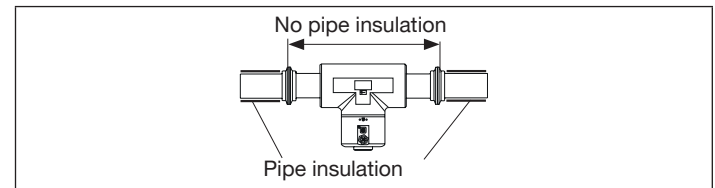

Fig. 10: Thermal insulation of the pipe

- To make sure the internal temperature of the transmitter does not exceed the authorized maximum value, install the device as recommended in “Fig. 11”.

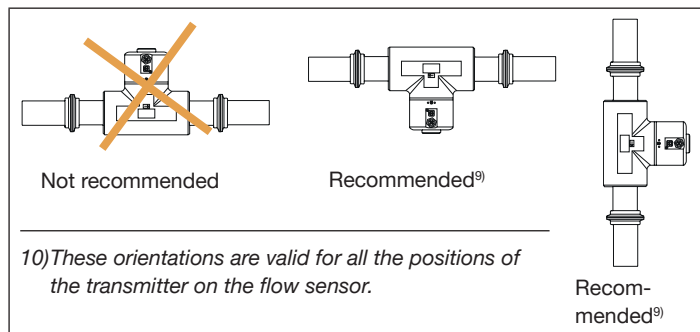

Fig. 11: Orientation of a device to avoid effects of high liquid temperatures

## 7.4 Installing the device into the pipe

### 7.4.1 Installing a device with clamp connections

For EHEDG conformity and clamp connections according to ASME BPE (DIN 32676 series C), DIN 32676 series A, DIN 32676 series B or SMS 3017 / ISO 2852 for pipes according to SMS 3008:

- Only use EHEDG-compliant seals from Combifit International B.V. (see also “EHEDG Position Paper” on the EHEDG website).

The clamp connections according to DIN 11864-3 series A, B and C are hygienic connections.

- Use any seals that are adapted to the process.

### Installation:

- Make sure that the seals are in good condition.
- Place seals adapted to the process (temperature, fluid type) in the grooves of the clamp connections.
- Attach the clamp connections to the pipe with clamp collars. Make sure that tightening the clamp collar does not create bulges at the gaskets.

### 7.4.2 Installing a device with flange connections

The flange connections according to DIN 11864-2 series A, B and C are hygienic connections.

- Use any seals that are adapted to the process.

### Installation:

- Make sure the seals are in good condition.
- Place seals adapted to the process (temperature, fluid type) in the flange connections.
- Use bolts with dimensions as given in the relevant flange standard and adapted to the process.
- Tighten the bolts to a torque as given in the relevant flange standard to fix the fitting to the pipe.

### 7.4.3 Installing a device with threaded connections according to DIN 11851 series A

Required connection parts according to DIN 11851 and corresponding DN:

- 2 weld liner
- 2 gaskets
- 2 nuts

For EHEDG conformity and threaded connections according to DIN 11851 Series A for pipes to DIN 11850:

- Only use EHEDG-compliant gaskets:
  - ASEPTO-STAR K-flex Upgrade gaskets from Kieselmann GmbH, Germany or
  - S.K.S. gasket set DIN 11851 EHEDG with EPDM or FKM inner gasket from Siersema Componenten Service (S.K.S.) B.V., Netherlands

**Installation:**

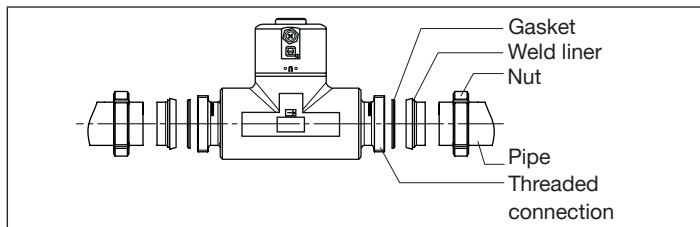

Fig. 12: Installation with threaded connections

- Ensure that the gaskets are in good condition.
- Slide the nuts onto the pipes and weld the weld liner to the pipes.
- Place seals adapted to the process (temperature, fluid type) between the threaded connection and the weld liner.
- Use the nuts to fix the weld liner to the threaded connections. When tightening the nut, make sure that there are no bulges on the seals.

## 8 ELECTRICAL INSTALLATION

### 8.1 Safety instructions



#### DANGER!

**Risk of injury from high pressure in the equipment/device.**

- ▶ Before working on equipment or device, switch off the pressure and deaerate/drain lines.
- ▶ Respect the regulations to the use of dangerous fluids.

**Risk of injury from electric shock.**

- ▶ Before working on the device or system, switch off the power supply. Secure against reactivation.
- ▶ Observe applicable accident prevention and safety regulations for electrical equipment.

**Risk of burns and risk of fire through hot device surface.**

- ▶ Use safety gloves to handle the device.
- ▶ Keep the device away from highly flammable substances and media.



#### WARNING!

**Risk of injury from improper installation.**

- ▶ Installation may be carried out by authorized technicians only and with the appropriate tools.

**Risk of injury from unintentional activation of the system and an uncontrolled restart.**

- ▶ Secure system from unintentional activation.
- ▶ Following installation, ensure a controlled restart.

**CAUTION!**

**Risk of injury due to a heavy device.**

A heavy device can fall down during transport or during installation and cause injuries.

- ▶ Transport, install and dismantle a heavy device with the help of another person.
- ▶ Use appropriate tools.

## 8.2 Requirements for electrical installation

**WARNING!**

**Risk of injury from improper installation.**

- ▶ Install the circuit breaker or the switch in an easily accessible place.
- ▶ Identify the circuit breaker or the switch as the disconnecting component for the electrical power supply to the device.
- ▶ Install overload devices that are appropriate for electrical installation.
- ▶ Observe standard NF C 15-100 / IEC 60364.

- Use a high quality electrical power supply, filtered and regulated.
- Do not install the cables near high voltage or high frequency cables; if this cannot be avoided, observe a minimum distance of 30 cm.



According to UL/EN 6101010-1:

- Double isolate all devices connected to the flow meter Type 8098 from the mains.
- All circuits connected to the flow meter Type 8098 must be limited energy circuits.

## 8.3 Additional documentation

Further information on büS can be found in the cabling guide for büS/EDIP at [www.burkert.com](http://www.burkert.com) under the type.

Further information on CANopen, which refers to the device, can be found in the operating manual “CANopen Network Configuration” at [www.burkert.com](http://www.burkert.com).

## 8.4 Connecting the device

### Pin assignment for variant without outputs:

Connection to supply voltage or supply voltage and communication:

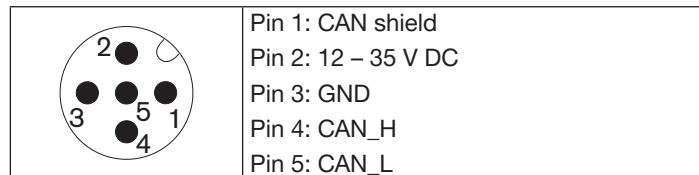

*Fig. 13: Pin assignment of the 5-pin M12 male connector  
Cable see accessories.*

## Type 8098

### Electrical installation

#### Pin assignment for variant with outputs:

Connection to supply voltage, communication and outputs:

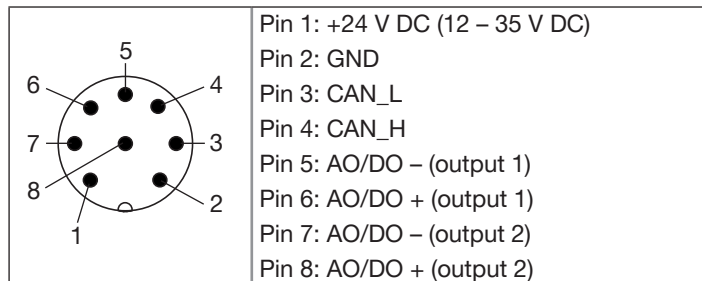

Fig. 14: Pin assignment of the 8-pin M12 male connector



The bÜS connection of the variant with outputs is only for connection to the Bürkert Communicator for configuration and software updating of the device. Due to the lack of CAN shielding, conventional bÜS/ CANopen communication is not recommended.

Cable see accessories.

#### ATTENTION!

**Danger of short circuit if output 1 is incorrectly configured.**

- ▶ Before connecting output 1, configure the output with the Bürkert Communicator as an analogue output or digital output. (Observe the notes in the operating instructions, chapter 17.2).

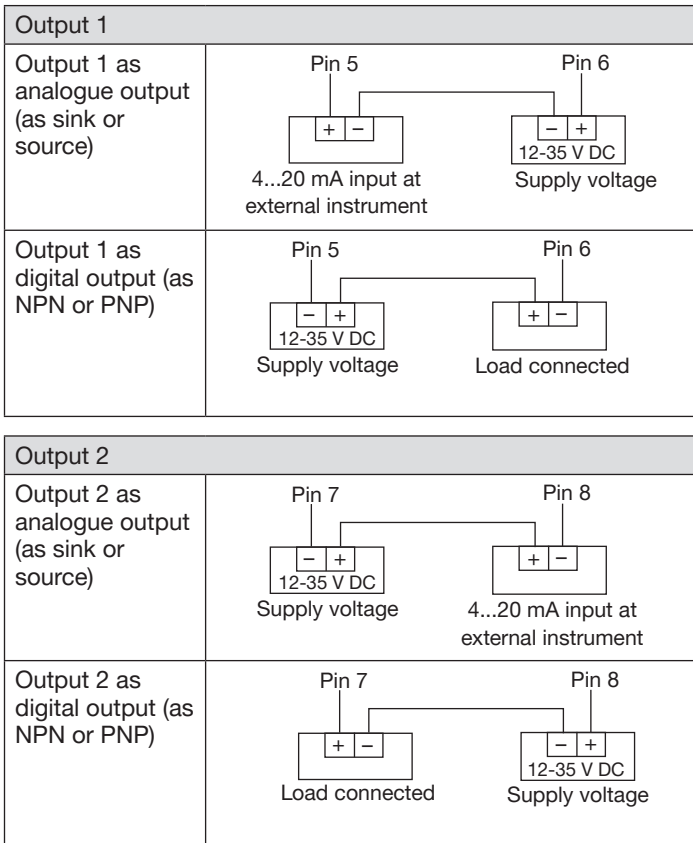

**Connect the device:**

- Use pre-assembled connection cable.
- Connect the M12 socket to the device and tighten (max. 0.6 Nm).
- Observe minimum supply voltage, see “Fig. 15”.
- Connect protective earth (see chapter “8.5”)
- If the device is connected to a bÜS network or to a CANopen network, either install a one or two 120 Ω termination resistors in the line or activate the device internal termination resistor with software: see chapter “Activating the device internal terminating resistor” in the operating instructions. The bÜS or CANopen line must be adapted to 60 Ω.

The minimum voltage to be supplied depends on the fluid temperature and on the ambient operating temperature.

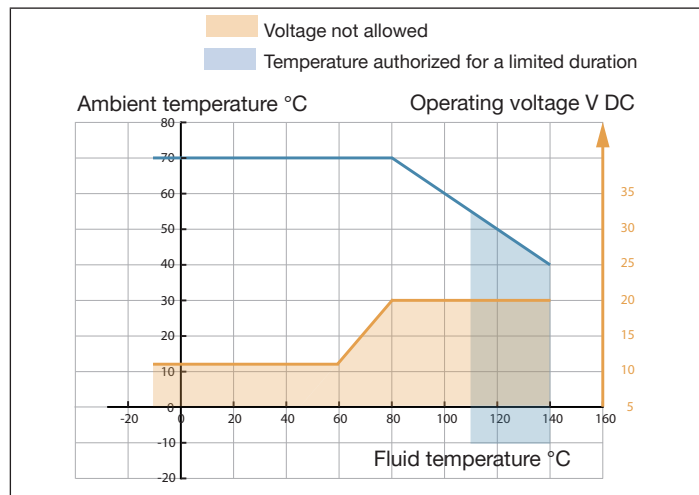

Fig. 15: Minimum supply voltage depending on the ambient temperature and the fluid temperature



## 8.5 Connecting the protective earth

For proper function of the device, connect the yellow/green conductor to the ground terminal on the outside of the transmitter housing as follows:

- Use ring cable lug for M4.
- Connect protective earth conductor with ring cable lug.
- Tighten the M4 screw with a torque of 1.8 – 2 Nm (1.3 – 1.4 ft-lbf).

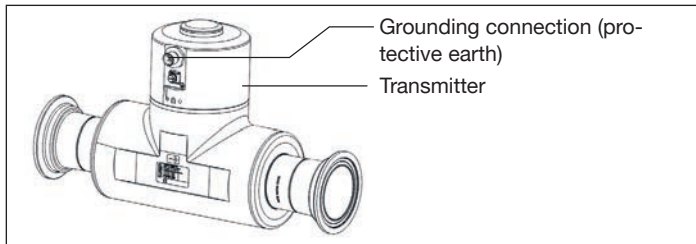

Fig. 16: Grounding connection

## 9 START-UP

### 9.1 Safety instructions



#### WARNING!

##### Risk of injury from improper operation.

Improper operation may result in injuries as well as damage to the device and the area around it.

- ▶ Before start-up, ensure that the operating personnel are familiar with and completely understand the contents of the operating instructions.
- ▶ Observe the safety instructions and intended use.
- ▶ Only adequately trained personnel may operate the equipment/the device.

### 9.2 Setting with Bürkert Communicator

The Bürkert Communicator can be used to make all settings on the device.



The settings in the Bürkert Communicator can be found in the operating manual.

#### 9.2.1 Connecting bÜS device with Bürkert Communicator

Required components (see “12 Accessories”):

- Communications software: Bürkert Communicator for PC
- USB-bÜS interface
- bÜS adapter cable

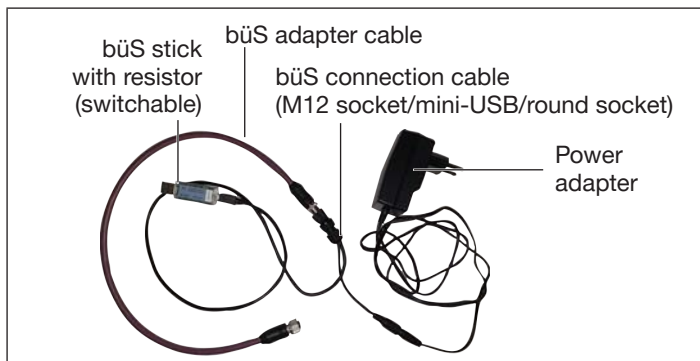

Fig. 17: USB-büS-Interface and büS adapter cable

- Establish connection to PC with USB-büS interface and büS adapter cable.
- Starting Bürkert Communicator.
- Implementing settings.

## 9.3 büS

### 9.3.1 Information, büS

büS is a system bus developed by Bürkert with a communication protocol based on CANopen.

### 9.3.2 Configuration of the fieldbus

The required start-up files and the description of objects are available on the Internet.



Download from:

[www.burkert.com](http://www.burkert.com) / Type 8098 / Software

## 10 DISPLAY ELEMENTS

### 10.1 Status indicator

As a default setting, the status display shows:

- Diagnostic status signals according to NAMUR NE 107 (red, orange, yellow and blue)
- Status of diagnostics active or inactive
- Identification in the büS network

The user can set the following LED modes for the display of device status and valve position.

- NAMUR mode (factory setting)
- Fixed color
- LED off

The LED mode and the colors of the valve position can be set with the Bürkert Communicator.



The description for setting the LED mode can be found in the section "Changing the operating mode of the device status LED or switching off the status LED" in the operating instruction.

### 10.2 NAMUR mode

The display elements change color in accordance with NAMUR NE 107.

If several device statuses exist simultaneously, the device status with the highest priority is displayed. The priority is determined by the severity of the deviation from normal operation (red status indicator = failure = highest priority).

**Status indicator in accordance with NE 107, edition 2006-06-12**

Color	Color code	Status	Description
Red	5	Outage, error or malfunction	Normal operation is not possible due to a malfunction in the device or on its peripheral equipment.
Orange	4	Function check	Work is being carried out on the device; normal operation is therefore temporarily not possible
Yellow	3	Out of specification	Ambient conditions or process conditions for the device are outside the specified area.
Blue	2	Maintenance required	The device is in normal operation, although a function is briefly restricted. → Service device.
Green	1	Diagnostics active	Device is operating perfectly. Status changes are indicated in different colors. Messages are transmitted via a fieldbus if connected.

**Status indicator in accordance with NE 107, edition 2006-06-12**

Color	Color code	Status	Description
White	0	Diagnostics inactive	Device is switched on. Status changes are not shown. Messages are neither listed nor transmitted via any connected fieldbus.

Tab. 6: Description of the colors

State	Status	Description
ON	Device is in operating state	Device is in standard operation.
Flashing rapidly	Identification	Serves as identification of a device in the bÜS network. The device was selected using the Bürkert Communicator software.

Tab. 7: Description of the status

## 11 MAINTENANCE AND TROUBLESHOOTING

### 11.1 Safety instructions



#### DANGER!

**Risk of injury from high pressure in the equipment/device.**

- ▶ Before working on equipment or device, switch off the pressure and deaerate/drain lines.
- ▶ Respect the regulations to the use of dangerous fluids.

**Risk of injury from electric shock.**

- ▶ Before working on the device or system, switch off the power supply. Secure against reactivation.
- ▶ Observe applicable accident prevention and safety regulations for electrical equipment.

**Risk of burns and risk of fire through hot device surface.**

- ▶ Use safety gloves to handle the device.
- ▶ Keep the device away from highly flammable substances and media.



#### WARNING!

**Risk of injury from improper maintenance.**

- ▶ Maintenance may be carried out by authorized technicians only and with the appropriate tools.

**Risk of injury from unintentional activation of the system and an uncontrolled restart.**

- ▶ Secure system from unintentional activation.
- ▶ Following installation, ensure a controlled restart.



#### CAUTION!

**Risk of injury due to a heavy device.**

A heavy device can fall down during transport or during installation and cause injuries.

- ▶ Transport, install and dismantle a heavy device with the help of another person.
- ▶ Use appropriate tools.

### 11.2 Information on returning the device to the manufacturer

- To return the device for calibration or any after sales service, use the original packaging.
- Send the device back to your local Bürkert sales office. The addresses of our international sales offices are available on the internet at [www.burkert.com](http://www.burkert.com)

### 11.3 Cleaning the outer surface of the device



- Always use a cleaning agent compatible with the materials from which the device is made.

The outer surface device can be cleaned with a cloth slightly dampened water or with a detergent compatible with the materials the device is made of.

Please feel free to contact your Bürkert supplier for any additional information.

## 11.4 Cleaning In Place (CIP) of the device

The measurement tube of the device can be cleaned in place in all the applications the device is used in.

→ Do the cleaning in place procedure at appropriate intervals to prevent malfunctions or contamination.

### ATTENTION!

The device and the seals used on the process connections can be damaged by the cleaning agents or the disinfecting agents.

- ▶ Use cleaning agents or disinfecting agents with a concentration that is compatible with the material the measurement tube is made of.
- ▶ Check the chemical compatibility of the cleaning agents or disinfecting agents with the materials of the seals used on the process connections.
- ▶ For more information on the chemical compatibility and the cleaning temperatures contact your local Bürkert sales office.
- ▶ Obey the cleaning in place procedure that is suited for your application.

Procedure for the cleaning in place of the device:

- Rinse the measurement tube with water of the best quality available in the factory (ideally, water for injection or purified water) under the following conditions:
  - at a temperature between 50 °C and 75 °C,
  - at a flow velocity between 1.5 m/s and 2.1 m/s,
  - for a duration that is determined by your CIP recipe.

- Prepare one or two cleaning agents at concentrations and with chemical properties that have proven their effectiveness on the residues to be removed. Make sure the concentration of the cleaning agent does not damage stainless steel 316L.
- Let the cleaning agent circulate through the measurement tube under the following conditions:
  - at a temperature between 50 °C and 75 °C,
  - at a flow velocity between 1.5 m/s and 2.1 m/s,
  - for a duration that is determined by your CIP recipe.
- Rinse the measurement tube with water of the best quality available in the factory (ideally, water for injection or purified water) under the same conditions as the first rinse.
- If needed, let a second cleaning agent circulate through the measurement tube, under the same conditions as the first cleaning agent, to neutralize any alkaline residues that remain.
- Do a final rinse of the measurement tube, under the same conditions as the first two rinses. Monitor the conductivity value of the final rinse to make sure all the cleaning agents have been removed.
- Blow air through the measurement tube to remove moisture and to ensure maintenance of a good passive layer.
- If needed, do a de-scaling by letting a solution made of water, nitric acid HNO<sub>3</sub> [15 – 20%] and hydrofluoric acid HF [2 – 5%] at a temperature between 20 °C and 60 °C circulate through the measurement tube for 5 – 30 minutes.

- After a de-scaling, or to prevent any corrosion effects after 1 or more (depending on the application) CIP-procedures, do a passivation by letting a solution made of water and nitric acid  $\text{HNO}_3$  [3 – 5%] at a temperature between 70 °C and 80 °C circulate through the measurement tube for the same duration as the CIP-procedure. Then, rinse the measurement tube with water with the best quality available in the factory (ideally, water for injection or purified water) under the same conditions as the other rinses.
- Blow air through the measurement tube to remove moisture and to ensure creation of a uniform passive layer.

### 11.5 Sterilisation In Place (SIP) of the device

The measurement tube of the device can be sterilised in place in all the applications the device is used in.

- Do the sterilisation in place procedure using dry saturated steam at a temperature between 121 °C and 140 °C for max. 1 hour.

### 11.6 Troubleshooting

By default, the status indicator shows diagnostic status signals according to NAMUR NE 107 (red, orange, yellow and blue). For description see chapter [“10.2 NAMUR mode”](#)

## 12 ACCESSORIES

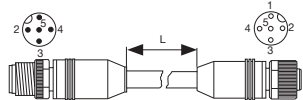
Designation	Order no.
Unlocking magnetic key	690309
5-pin M12 female straight cable plug with plastic threaded locking ring, to be wired	917116
8-pin straight female M12 connector and strands with wire end ferrules, cable length 2 m	919061
büS adapter: 8-pin straight female M12 connector and 5-pin straight male M12 connector, cable length 0.5 m	773286
Communication software Bürkert Communicator	Information at <a href="http://www.burkert.com">www.burkert.com</a>
 USB-büS interface set:	772426
	
büS cable extension (M12), length 1 m	772404
büS cable extension (M12), length 3 m	772405
büS cable extension (M12), length 5 m	772406
büS cable extension (M12), length 10 m	772407

Tab. 8: Accessories

## 12.1 Communications software

The PC operating program “Communicator” is designed for communication with the devices from the Bürkert positioner family.



A detailed description and precise schedule of the procedure for the installation and operation of the software can be found in the associated documentation.

Download the software at: [www.burkert.com](http://www.burkert.com)

## 13 TRANSPORTATION, STORAGE, DISPOSAL



### CAUTION!

**Risk of injury due to a heavy device.**

A heavy device can fall down during transport or during installation and cause injuries.

- ▶ Transport, install and dismantle a heavy device with the help of another person.
- ▶ Use appropriate tools.

### ATTENTION!

**Damage in transit due to inadequately protected devices.**

- ▶ Protect the device against moisture and dirt in shock-resistant packaging during transportation.
- ▶ Observe permitted storage temperature.

### ATTENTION!

**Incorrect storage may damage the device.**

- ▶ Store the device in a dry and dust-free location.
- ▶ Storage temperature: -20 to +70 °C

### ATTENTION!

**Damage to the environment caused by device components contaminated with media.**

- ▶ Dispose of the device and packaging in an environmentally friendly manner.
- ▶ Observe applicable disposal and environmental regulations.



Observe national regulations on the disposal of waste.

## 14 DISPOSAL OF THE DEVICE

### ATTENTION!

**Damage to the environment due to parts contaminated by the fluid.**

- ▶ Dispose of the device and its packaging in an environmentally-friendly way.
- ▶ Comply with the regulations which concern the area of waste disposal.







[www.burkert.com](http://www.burkert.com)