

Type 8025 / SE35

Battery powered flowmeter and battery powered flow transmitter
Durchflussmesser mit Batterien und Durchflusstransmitter mit Batterien
Débitmètre à piles et transmetteur de débit à piles



Operating Instructions (from serial number 10000)

Bedienungsanleitung (ab Seriennummer 10000)

Manuel d'utilisation (à partir du numéro de série 10000)

We reserve the right to make technical changes without notice.
Technische Änderungen vorbehalten.
Sous réserve de modifications techniques.

© Bürkert SAS, 2013-2017

Operating Instructions 1712/03_EU-ML 00566970 Original_FR

1. ABOUT THE OPERATING INSTRUCTIONS	5	7. INSTALLATION	12
1.1. Symbols used	5	7.1. Safety instructions	12
1.2. Definition of the word "device"	5	7.2. Installation of flowmeter 8025	13
1.3. Validity of the Operating Instructions	6	7.2.1. Install the S020 fitting on the pipe	13
2. INTENDED USE	6	7.2.2. Install the flowmeter type 8025 into the S020 fitting	15
3. BASIC SAFETY INFORMATION	6	7.2.3. Complete the installation	15
4. GENERAL INFORMATION	8	7.3. Installation of the 8035	15
4.1. Manufacturer's address and international contacts	8	7.3.1. Install the S030 sensor-fitting on the pipe	15
4.2. Warranty conditions	8	7.3.2. Install the flow transmitter type SE35 on the	16
4.3. Information on the Internet	8	S030 sensor-fitting	16
5. DESCRIPTION	8	7.3.3. Complete the installation of the 8035	16
5.1. Description of the rating plate	9	7.4. Description of the electronic board connections	16
6. TECHNICAL DATA	9	8. ADJUSTMENT, COMMISSIONING	17
6.1. Conditions of use	9	8.1. Safety instructions	17
6.2. Conformity to standards and directives	9	8.2. Preparing the device for adjustment	17
6.2.1. Conformity to the pressure equipment directive	10	8.3. Description of the navigation keys and the	18
6.2.2. UL certification	10	status LED	18
6.3. Material data	10	8.4. Default settings of the device	19
6.4. Dimensions	10	8.5. Operating levels of the device	19
6.5. Fluid and electrical data	11	8.6. Details of the Process level	21
		8.7. Details of the Parameters menu	21

8.7.1. Choosing the display language	22	9.4.1. Resolution of problems when the device status LED is OFF	37
8.7.2. Choosing the flow rate units, the number of decimals and the units of the totalizers	22	9.4.2. Resolution of problems when the device status LED is red and flashing	38
8.7.3. Entering or determining the K factor of the fitting used	24	9.4.3. Resolution of problems linked to warning messages and device status LED is orange and flashing	39
8.7.4. Determining the fitting K factor using a Teach-In procedure	25	10. SPARE PARTS AND ACCESSORIES	40
8.7.5. Configuring the filter	28	10.1. Flow transmitter SE35	40
8.7.6. Resetting both totalizers	30	10.2. Flowmeter 8025	41
8.8. Details of the Test menu	31	11. PACKAGING, TRANSPORT	41
8.8.1. Reading the rotational frequency of the paddle wheel	32	12. STORAGE	41
8.8.2. Monitoring the flow rate in the pipe	32	13. DISPOSAL OF THE DEVICE	41
8.8.3. Monitoring the value of the daily totalizer	34		
8.9. Details of the Information menu	34		
8.9.1. Reading the capacity of the batteries	35		
9. MAINTENANCE AND TROUBLESHOOTING	35		
9.1. Cleaning the device	36		
9.2. Cleaning the flow sensor for the 8025	36		
9.3. Replacing the batteries	36		
9.4. If you encounter problems	37		

1. ABOUT THE OPERATING INSTRUCTIONS

The Operating Instructions describe the entire life cycle of the device. Please keep the Operating Instructions in a safe place, accessible to all users and any new owners.

The Operating Instructions contain important safety information.

Failure to comply with these instructions can lead to hazardous situations. Pay attention in particular to the chapters [3. Basic safety information](#) and [2. Intended use](#).

- ▶ Whatever the version of the device, the Operating Instructions must be read and understood.

- ▶ When the symbol  is marked inside or outside the device, carefully read the Operating Instructions.

1.1. Symbols used



DANGER

Warns against an imminent danger.

- ▶ Failure to observe this warning can result in death or in serious injury.



WARNING

Warns against a potentially dangerous situation.

- ▶ Failure to observe this warning can result in serious injury or even death.



CAUTION

Warns against a possible risk.

- ▶ Failure to observe this warning can result in substantial or minor injuries.

NOTICE

Warns against material damage.



Advice or important recommendations.



Refers to information contained in the Operating Instructions or in other documents.

- ▶ Indicates an instruction to be carried out to avoid a danger, a warning or a possible risk.

→ Indicates a procedure to be carried out.

- ✔ Indicates the result of a specific instruction.

1.2. Definition of the word "device"

The word "device" used in the Operating Instructions refers to the battery powered flowmeter type 8025 or the battery powered flow transmitter type SE35.

1.3. Validity of the Operating Instructions

The Operating Instructions are valid for the battery powered devices type 8025 / SE35, with a series number equal or higher than 10000.

2. INTENDED USE

Use of the device that does not comply with the instructions could present risks to people, nearby installations and the environment.

The flowmeter type 8025, or the flow transmitter type SE35 mounted on a sensor-fitting, is intended to measure the flow rate of a liquid and to totalize the volume of liquid.

- ▶ Use the device in compliance with the characteristics and commissioning and use conditions specified in the contractual documents and in the Operating Instructions.
- ▶ Never use the device for security applications.
- ▶ Protect the device against electromagnetic interference, ultra-violet rays and, when installed outdoors, the effects of climatic conditions.
- ▶ Only operate a device in perfect working order.
- ▶ Store, transport, install and operate the device properly.
- ▶ Only use the device as intended.

3. BASIC SAFETY INFORMATION

This safety information does not take into account any contingencies or occurrences that may arise during installation, use and maintenance of the device.

The operating company is responsible for the respect of the local safety regulations including for the staff safety.



DANGER

Risk of injury due to high pressure in the installation.

- ▶ Before any intervention on the installation, stop the circulation of fluid, cut off the pressure and drain the pipe.

Risk of injury due to electrical voltage.

- ▶ Put the power switch to OFF before carrying out work on the device.
- ▶ Observe all applicable accident protection and safety regulations for electrical equipment.

Risk of burn injury due to high fluid temperatures.

- ▶ Do not touch with bare hands the parts of the device that are in contact with the fluid.
- ▶ Before opening the pipe, stop the circulation of fluid and drain the pipe.

Risk of injury due to the nature of the fluid.

- ▶ Respect the prevailing regulations on accident prevention and safety relating to the use of dangerous fluids.



Various dangerous situations

To avoid injury:

- ▶ Do not use the device in explosive atmospheres.
- ▶ Do not use the device in an environment incompatible with the materials it is made of.
- ▶ Do not use fluid that is incompatible with the materials the device is made of.
- ▶ Do not subject the device to mechanical stress.
- ▶ Do not make any modifications to the device.
- ▶ Prevent any unintentional power supply switch-on.
- ▶ Only qualified and skilled staff can carry out the installation and maintenance work.
- ▶ Guarantee a defined or controlled restarting of the process, after a power supply interruption.
- ▶ Observe the general technical rules.



WARNING

Risk of burn injury due to the leakage of the chemicals from the batteries if the batteries are exposed to high temperatures.

- ▶ Respect the operating temperature of the batteries.

NOTICE

The device may be damaged by the fluid in contact with.

- ▶ Systematically check the chemical compatibility of the component materials of the device and the fluids likely to come into contact with the materials (for example: alcohols, strong or concentrated acids, aldehydes, alkaline compounds, esters, aliphatic compounds, ketones, halogenated aromatics or hydrocarbons, oxidants and chlorinated agents).

NOTICE

Elements / Components sensitive to electrostatic discharges

This device contains electronic components sensitive to electrostatic discharges. They may be damaged if they are touched by an electrostatically charged person or object. In the worst case scenario, these components are instantly destroyed or go out of order as soon as they are activated.

- ▶ To minimise or even avoid all damage due to an electrostatic discharge, take all the precautions described in standard EN 61340-5-1.
- ▶ Also ensure that you do not touch any of the live electrical components.

NOTICE

The device may be damaged because the IP65 protection rating is not guaranteed if the lateral plugs of the flow transmitter are loose.

- ▶ Do not unscrew the lateral plugs.

4. GENERAL INFORMATION

4.1. Manufacturer's address and international contacts

To contact the manufacturer of the device, use following address:

Bürkert SAS

Rue du Giessen

BP 21

F-67220 TRIEMBACH-AU-VAL

You may also contact your local Bürkert sales office.

The addresses of our international sales offices are available on the internet at: www.burkert.com

4.2. Warranty conditions

The condition governing the legal warranty is the conforming use of the device type 8025 or SE35 in observance of the operating conditions specified in these Operating Instructions.

4.3. Information on the Internet

You can find the Operating Instructions and technical data sheets regarding the type SE35 or 8025 at: www.burkert.com

5. DESCRIPTION

The flowmeter type 8025 is made up of a paddle wheel flow sensor and a flow transmitter with a display and a cover with lid. The flowmeter type 8025 must be engaged in a fitting type S020.

The SE35 is a flow transmitter with a display and a cover with lid. The flow transmitter type SE35 must be mounted on a sensor-fitting. A flow transmitter type SE35 mounted on a sensor-fitting type S030 is called 8035.

The device is energized by 4 non-rechargeable AA alkaline batteries of 1.5 V each.

5.1. Description of the rating plate

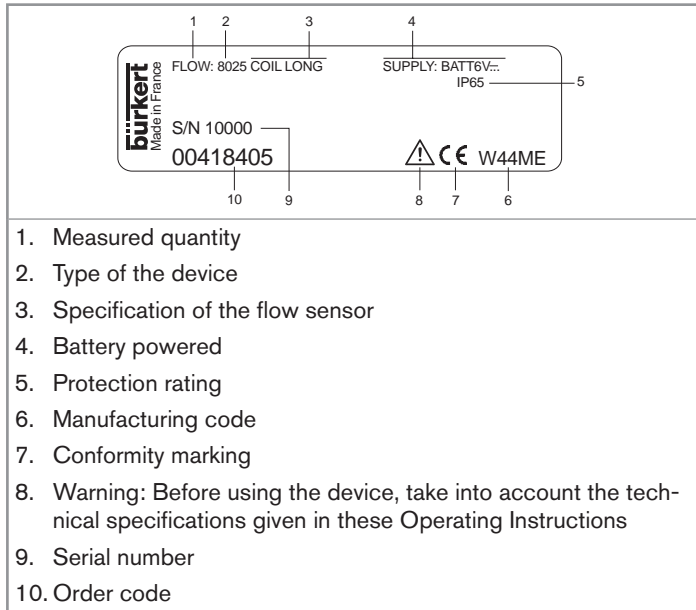

Fig. 1: Rating plate of the device (example)

6. TECHNICAL DATA

6.1. Conditions of use

Ambient temperature	-10...+55 °C (with the delivered batteries) When using batteries with a different brand, the ambient temperature range can be more restrictive.
Air humidity	< 80 %, non condensated
Height above sea level	max. 2000 m
Protection rating	IP65, cover lid and lateral plugs all screwed tight.

6.2. Conformity to standards and directives

The applied standards, which verify conformity with the EU directives, can be found on the EU-type examination certificate and/or the EU declaration of conformity (if applicable).

6.2.1. Conformity to the pressure equipment directive

The device conforms to article 4§1 of the Pressure Equipment Directive 2014/68/EU under following conditions:

- The flowmeter type 8025 can only be used in the following cases (depending on the maximum pressure, the DN of the pipe and the fluid):



Type of fluid	Conditions (8025)
Fluid group 1, art. 4 §1.c.i	only DN25
Fluid group 2, art. 4 §1.c.i	DN ≤ 32 or PNxDN ≤ 1000
Fluid group 1, art. 4 §1.c.ii	DN ≤ 25 or PNxDN ≤ 2000
Fluid group 2, art. 4 §1.c.ii	DN ≤ 200 or PN ≤ 10 or PNxDN ≤ 5000

- For the flow transmitter type SE35, refer to the Operating Instructions of the sensor-fitting used.

6.2.2. UL certification

The devices with variable key PU01 or PU02 are UL-certified devices and comply also with the following standards:

- UL 61010-1
- CAN/CSA-C22.2 n°61010-1

Identification on the device	Certification	Variable key
	UL-recognized	PU01
 Measuring Equipment EXXXXXX	UL-listed	PU02

6.3. Material data

Part	Material
Housing / seal	PC / NBR
Cover with lid / seal	PC / silicone
Front foil	Polyester
M20x1.5 screw plugs / seal	PA / neoprene
Screws	Stainless steel
Nut	PC
Flow sensor (exposed to the fluid) / seal (only with 8025)	PVDF / FKM
Axis and bearings of the paddle wheel.	ceramic
Rating plate	Polyester

6.4. Dimensions

→ Please refer to the technical data sheet related to the device at:
www.burkert.com

6.5. Fluid and electrical data

Fluid temperature	<p>The fluid temperature may be restricted by the fluid pressure or by the material of the fitting used: See Fig. 2 or Fig. 3 and the Operating Instructions of the fitting used.</p> <p>The maximal fluid temperature may be restricted by the maximal operating temperature of the batteries used</p>
Fluid pressure	<p>The fluid pressure may be restricted by the fluid temperature or by the material of the fitting used: See Fig. 2 or Fig. 3 and the Operating Instructions of the fitting used.</p>
Flow rate measurement	
▪ Measurement range	▪ 0.3...10 m/s
▪ Measurement deviation	
- with K-factor determined with a Teach-In procedure	- ±1 % of the measured value * (at the value of the Teach-In flow rate)
- with standard K-factor	- ±2.5 % of the measured value *
▪ Linearity	▪ ±0.5 % of the full scale (10 m/s)
▪ Repeatability	▪ ±0.4 % of the measured value *

Power supply	<p>4 1.5-V-batteries, connected in series</p> <p>Minimum charge: 4 years at 20 °C in the reasonably expected conditions of use of the device and from the date of manufacture of the device.</p>
---------------------	--

* Determined in the following reference conditions: fluid = water, water and ambient temperatures = 20 °C, upstream and downstream distances respected, appropriate pipe dimensions.

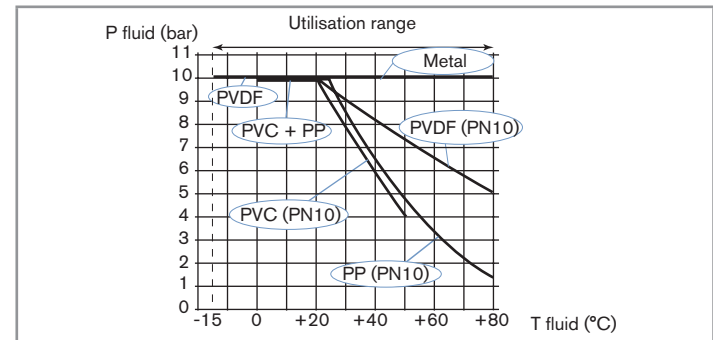

Fig. 2: Fluid temperature - Fluid pressure dependency curves for the 8025, depending on the material of the fitting S020

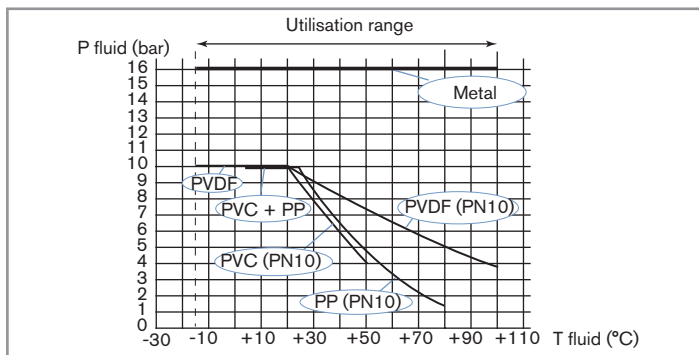

Fig. 3: Fluid temperature - Fluid pressure dependency curves for the sensor-fitting S030, depending on the material it is made of

7. INSTALLATION

7.1. Safety instructions



DANGER

Risk of injury due to high pressure in the installation.

- ▶ Before any intervention on the installation, stop the circulation of fluid, cut off the pressure and drain the pipe.

Risk of injury due to electrical voltage.

- ▶ Put the power switch to OFF before carrying out work on the device.
- ▶ Observe all applicable accident protection and safety regulations for electrical equipment.

Risk of burn injury due to high fluid temperatures.

- ▶ Do not touch with bare hands the parts of the device that are in contact with the fluid.
- ▶ Before opening the pipe, stop the circulation of fluid and drain the pipe.

Risk of injury due to the nature of the fluid.

- ▶ Respect the prevailing regulations on accident prevention and safety relating to the use of aggressive fluids.



WARNING

Risk of burn injury due to the leakage of the chemicals from the batteries if the batteries are exposed to high temperatures.

- ▶ Respect the operating temperature of the batteries.



WARNING

Risk of injury due to non-conforming installation.

- ▶ The fluid installation can only be carried out by qualified and skilled staff with the appropriate tools.
- ▶ Respect the assembly instructions for the fitting used.

Risk of injury due to unintentional switch on of power supply or uncontrolled restarting of the installation.

- ▶ Take appropriate measures to avoid unintentional activation of the installation.
- ▶ Ensure that the restart of the installation is controlled after any interventions.



WARNING

Risk of injury if the fluid pressure/temperature dependency is not respected.

- ▶ Take account of fluid temperature-pressure dependency according to the nature of the materials the fitting is made of (see the technical data and the Operating Instructions of the fitting used).
- ▶ Comply with the Pressure Equipment Directive 2014/68/EU.



Protect this device against electromagnetic interference, ultraviolet rays and, when installed outdoors, the effects of the climatic conditions.

7.2. Installation of flowmeter 8025

The flowmeter type 8025 is inserted into an S020 fitting mounted on the pipe:

1. Install the S020 fitting on the pipe,
2. Install the flowmeter type 8025 into the S020 fitting,
3. Complete the installation.

7.2.1. Install the S020 fitting on the pipe

→ Select an S020 fitting suitable for the speed of the fluid in the pipes.



To select a fitting, refer to the calculation tables on the technical data sheet for the relevant fitting.

→ Choose a position for the fitting according to the design of the pipes, in such a way that:

- the upstream and downstream distances are respected according to the design of the pipes, see [Fig. 4](#) and norm EN ISO 5167-1,
- the pipe is always filled in the section around the device (see [Fig. 5](#)),
- when the fitting is mounted vertically, the flow direction of the fluid is upwards (see [Fig. 5](#)),
- air bubbles do not form in the pipe in the section around the device (see [Fig. 5](#)).

- If necessary, use a flow conditioner to obtain the best accuracy.
- Install the fitting on the pipe according to the instructions in the relevant Operating Instructions.

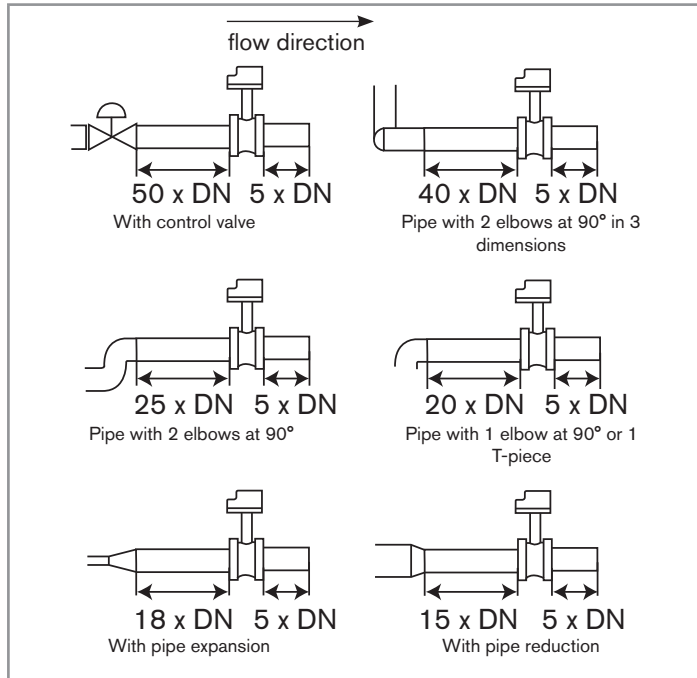

Fig. 4: Upstream and downstream distances depending on the design of the pipes

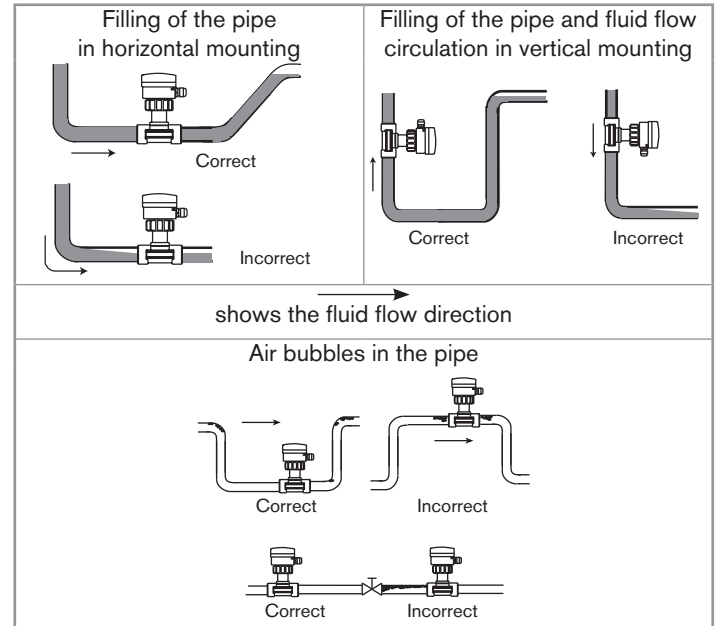

Fig. 5: Filling of the pipe, flow direction of the fluid, vertical mounting, air bubbles in the pipe

7.2.2. Install the flowmeter type 8025 into the S020 fitting

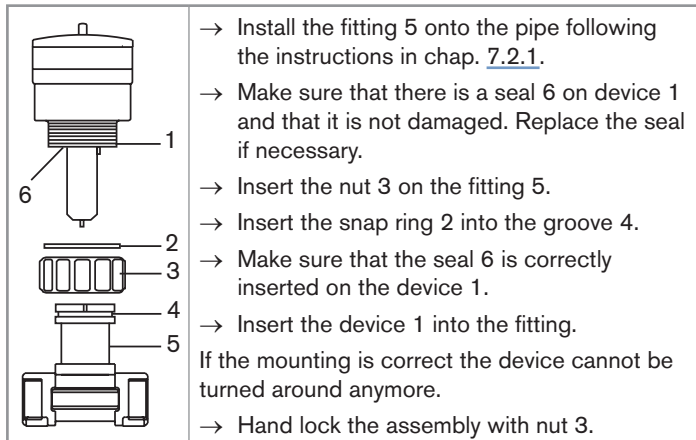

Fig. 6: Installation of a flowmeter type 8025 into an S020 fitting

7.2.3. Complete the installation

- Switch the device on (see chap. 8.2).
- Set the K-factor or have it calculated with a Teach-In procedure (see chap. 8.7.4).

7.3. Installation of the 8035

The 8035 comprises a flow transmitter type SE35 and a sensor-fitting type S030. The flow transmitter type SE35 is assembled on the S030 sensor-fitting by a quarter-turn rotation system:

1. Install the S030 sensor-fitting on the pipe,
2. Install the flow transmitter type SE35 on the S030 sensor-fitting,
3. Complete the installation of the 8035.

7.3.1. Install the S030 sensor-fitting on the pipe

- Select an S030 sensor-fitting suitable for the speed of the fluid in the pipes.



To select a sensor-fitting, refer to the calculation tables on the technical data sheet for the relevant sensor-fitting.

- Choose a position for the sensor-fitting according to the design of the pipes, in such a way that:
 - the upstream and downstream distances are respected according to the design of the pipes, see Fig. 4, page 14, and norm EN ISO 5167-1,
 - the pipe is always filled in the section around the device (see Fig. 5, page 14),
 - when the sensor-fitting is mounted vertically, the flow direction of the fluid is upwards (see Fig. 5, page 14),
 - air bubbles do not form in the pipe in the section around the device (see Fig. 5, page 14).

- If necessary, use a flow conditioner to obtain the best accuracy,
- Install the sensor-fitting on the pipes according to the instructions in the relevant Operating Instructions.

7.3.2. Install the flow transmitter type SE35 on the S030 sensor-fitting

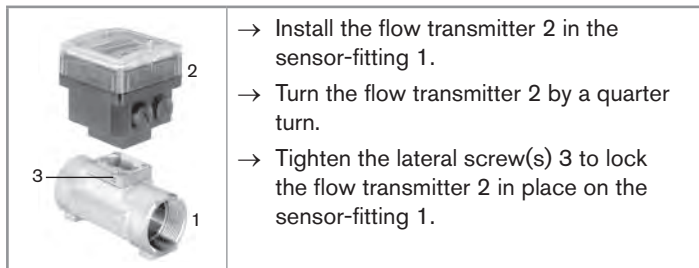

- Install the flow transmitter 2 in the sensor-fitting 1.
- Turn the flow transmitter 2 by a quarter turn.
- Tighten the lateral screw(s) 3 to lock the flow transmitter 2 in place on the sensor-fitting 1.

Fig. 7: Installation of the flow transmitter SE35 on the sensor-fitting S030

7.3.3. Complete the installation of the 8035

- Switch the device on (see chap. 8.2).
- Set the K-factor or have it calculated with a Teach-In procedure (see chap. 8.7.4).

7.4. Description of the electronic board connections

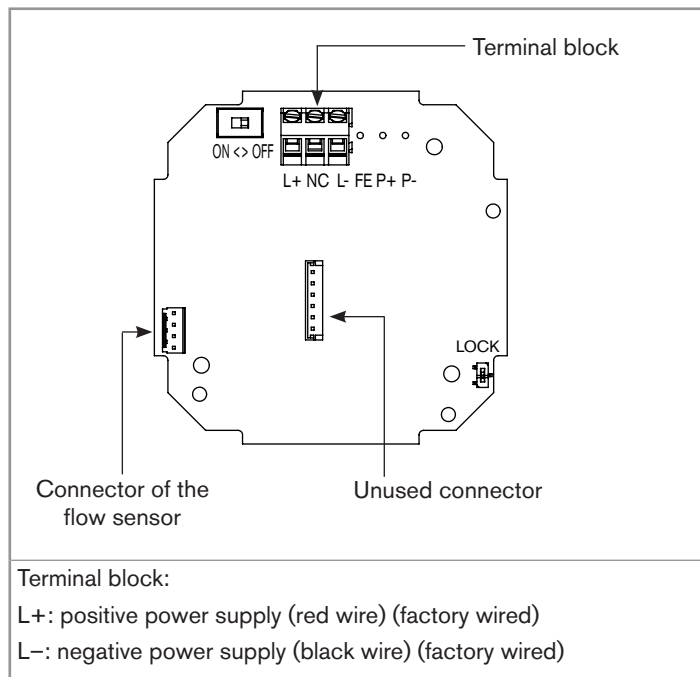

Fig. 8: Electronic board connections

8. ADJUSTMENT, COMMISSIONING

8.1. Safety instructions



WARNING

Risk of injury due to non-conforming operating.

Non-conforming operating could lead to injuries and damage the device and its surroundings.

- ▶ The operators in charge of operating must have read and understood the contents of the Operating Instructions.
- ▶ In particular, observe the safety recommendations and intended use.
- ▶ The device/installation must only be operated by suitably trained staff.

Danger due to non-conforming commissioning.

Non-conforming commissioning could lead to injuries and damage the device and its surroundings.

- ▶ Before commissioning, make sure that the staff in charge have read and fully understood the contents of the Operating Instructions.
- ▶ Before commissioning the device, adjust the K factor. See chap. [8.7.3](#)
- ▶ In particular, observe the safety recommendations and intended use.
- ▶ The device / the installation must only be commissioned by suitably trained staff.

8.2. Preparing the device for adjustment

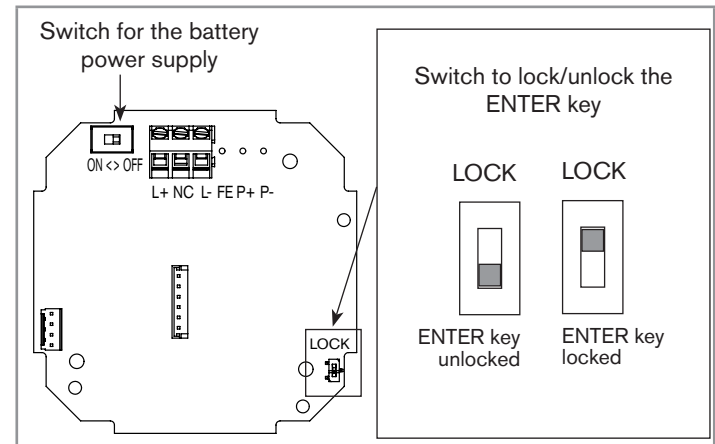

Fig. 9: Switches on the electronic board

- Loosen the screw and flip the lid.
- Loosen the 4 screws and take off the cover of the housing.
- Put the cover down so that the wires connected to the terminal block and the wire which connects the flow sensor to the electronic board are not subject to mechanical stress.
- Make sure that the ENTER key is unlocked. See [Fig. 9](#).
- Put the power supply switch to ON. See [Fig. 9](#).
- Put back the cover and tighten the 4 screws in an alternating pattern, to make sure that the device is tight.

→ Adjust the device: see chap. [8.3](#) to [8.8](#).

8.3. Description of the navigation keys and the status LED

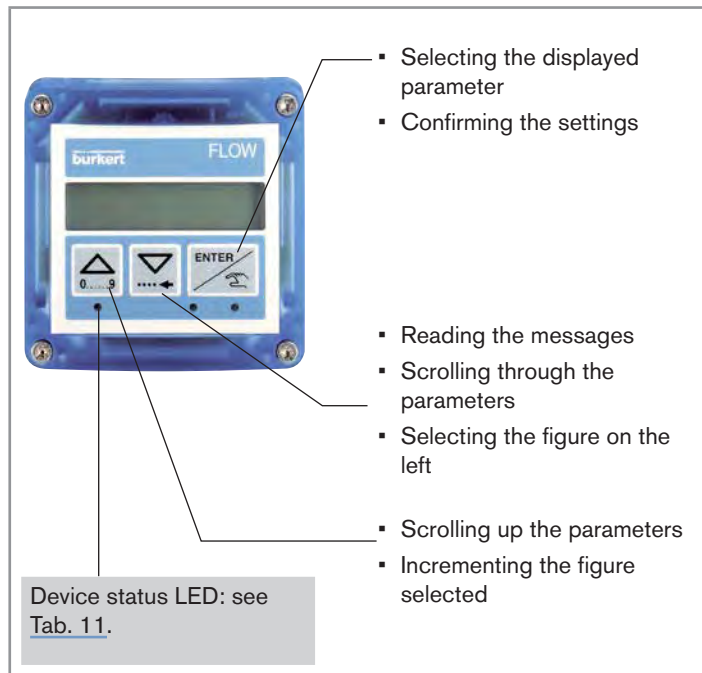







Fig. 10: Foil of the device

Tab. 11: State of the device indicated by the device status LED

Device status LED	Status of the device
OFF	The device operates correctly.
Orange, flashing	A warning message is generated. → Press the  key for 2 seconds in the Process level to access the message. See chap. 9.4.3 for the meaning of the message.
Red, flashing	An error message has been generated. → Press the  key for 2 seconds in the Process level to access the message. See chap. 9.4.2 for the meaning of the message.

Tab. 12: Description of the navigation keys

You want to...	Press...
move in the parameters of a level.	<ul style="list-style-type: none"> ▪  to go to the next parameter. ▪  to go to the previous parameter.
access the Configuration level.	 +  simultaneously for 5 s, in the Process level

You want to...	Press...
access the Test menu.	+ + simultaneously for 5 s, in the Process level
access the Information menu.	for 2 s, in the Process level, when the device status LED is orange or red.
reset the daily totalizer.	+ simultaneously for 2 s, when the daily totalizer is displayed in the Process level
select the displayed parameter.	
confirm the displayed value.	
activate the automatic scrolling of the values displayed in the Process level	for 2 s, in the Process level. → To stop the automatic scrolling, press any key.
modify a numerical value.	<ul style="list-style-type: none"> ▪ to increase the blinking digit. ▪ to select the digit at the left of the blinking digit. ▪ + to move the decimal point.

8.4. Default settings of the device

Function	Default value
LANGUAGE	English
UNIT of the flow rate	l/min
UNIT of the totalizers	litre
Number of decimals	Auto
K factor	1
FILTER	Filter 2
WARNING-FLOW	W- = W+ = 0.000
WARNING-VOLUME	000000

8.5. Operating levels of the device

The device has two operating levels: the Process level and the Configuration level.

The Process level makes it possible:

- to read the flow rate measured by the device and the value of the totalizers, the main and the daily ones.
- to reset the daily totalizer.
- to access the Configuration level.

The Configuration level makes it possible:

- to set the device parameters.
- to read the rotational frequency of the paddle wheel.
- to read the charge of the batteries.
- to read the error or warning messages generated by the device.

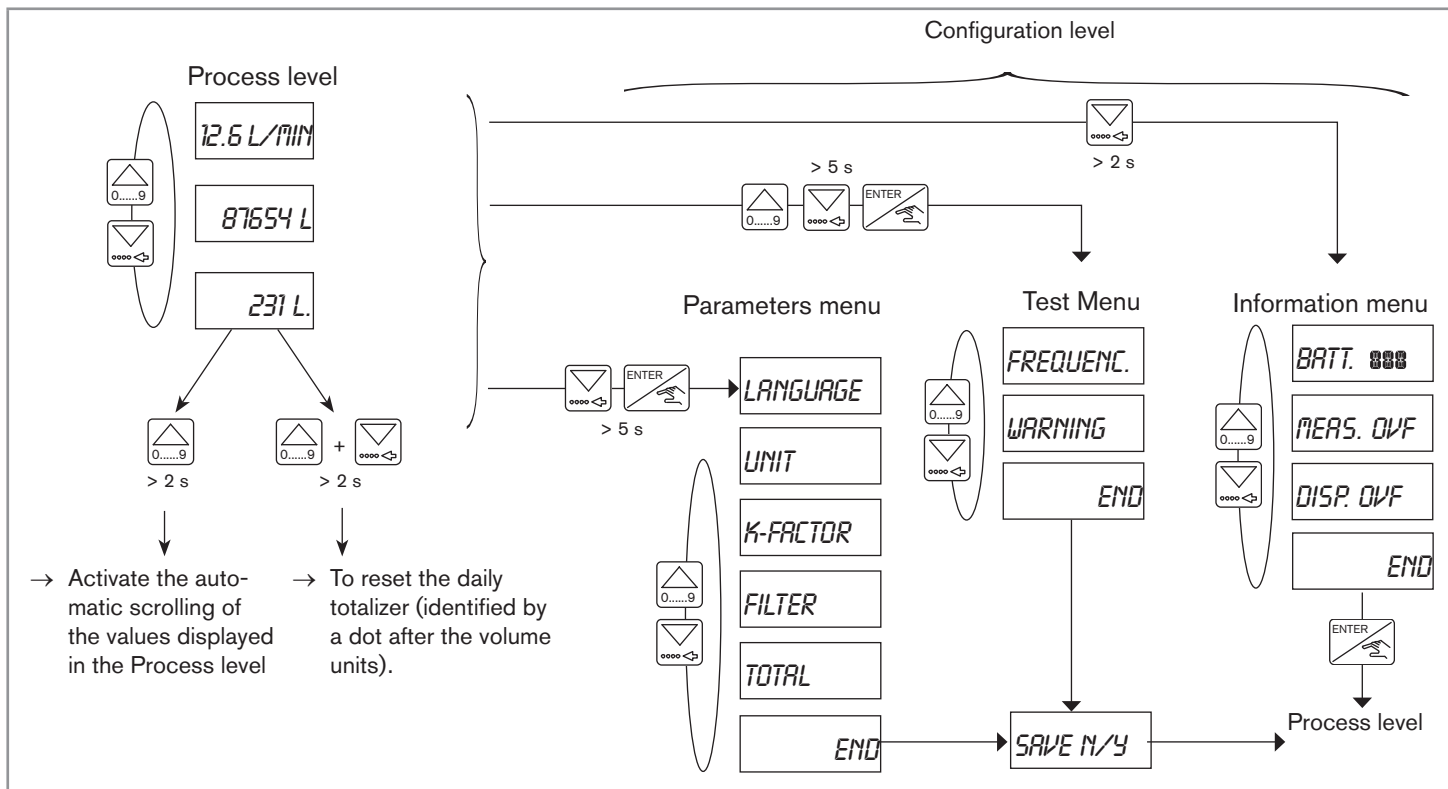

Fig. 13: Diagram of the levels of the device

8.6. Details of the Process level

This level is active by default when the device is energized.

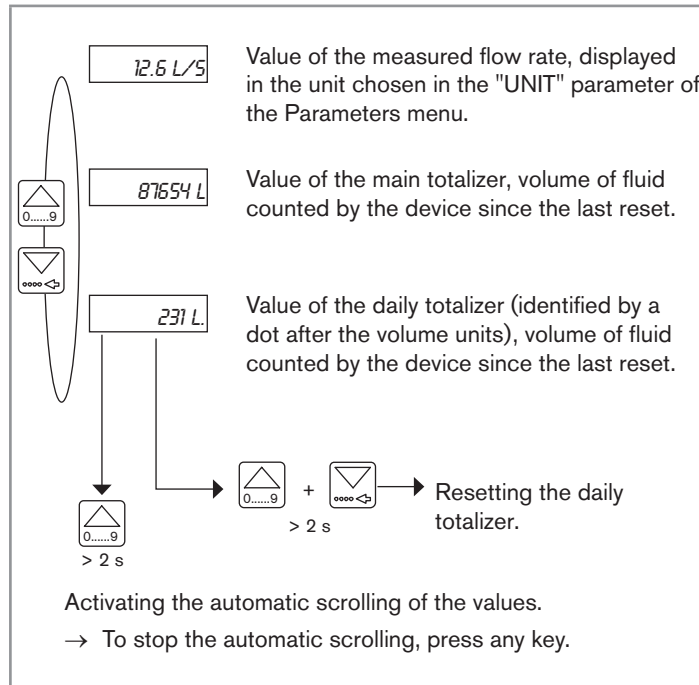



Fig. 14: Details of the Process level

8.7. Details of the Parameters menu

To access the Parameters menu, simultaneously press keys   for at least 5 s.

This menu comprises the following configurable parameters:

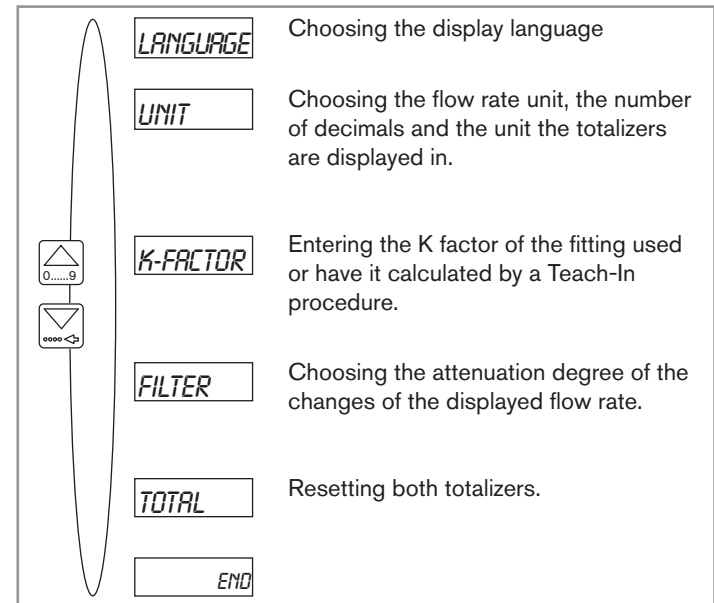



Fig. 15: Diagram of the Parameters menu

→ When you have done all the settings in this menu, go to the "END" parameter and press  to save the settings or not and to go back to the Process level.

8.7.1. Choosing the display language

When the device is energized for the first time, the display language is English.

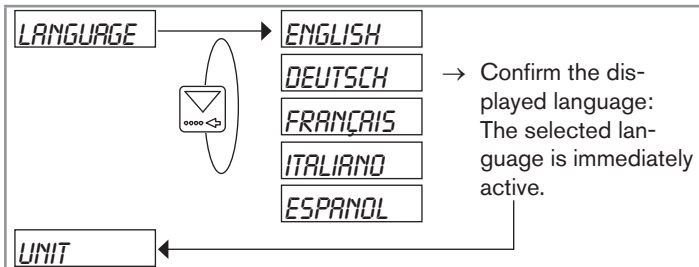

Fig. 16: Diagram of the "LANGUAGE" parameter of the Parameters menu

8.7.2. Choosing the flow rate units, the number of decimals and the units of the totalizers



When the flow rate units have been changed:

- change the value of the K factor, by hand,
- reset both totalizers, by hand.



The maximal flow rate that can be displayed depends on the number of decimals chosen:

- 9999 if the number of decimals = 0 or AUTO,
- 999,9 if the number of decimals = 1,
- 99,99 if the number of decimals = 2,
- 9,999 if the number of decimals = 3.



The maximal volume that can be displayed by the totalizers depends on the chosen units of the volume:

- 9 999 999 if the chosen units of the volume is "litre",
- 999 999 if the chosen units of the volume is "m³", or "gallon".

The "UNIT" parameter makes it possible to choose:

- the flow rate units.
- a fixed number of decimals (choose 0, 1, 2 or 3) to display the flow rate in the Process level, or a floating decimal point (choose "AUTO": the device automatically adjusts the position of the decimal point depending on the chosen units and the measured flow rate).
- the volume units of the totalizers if the unit previously chosen is in litres or in m³.
The totalizer values are automatically displayed in gallons if the flow rate units chosen is in gallons.

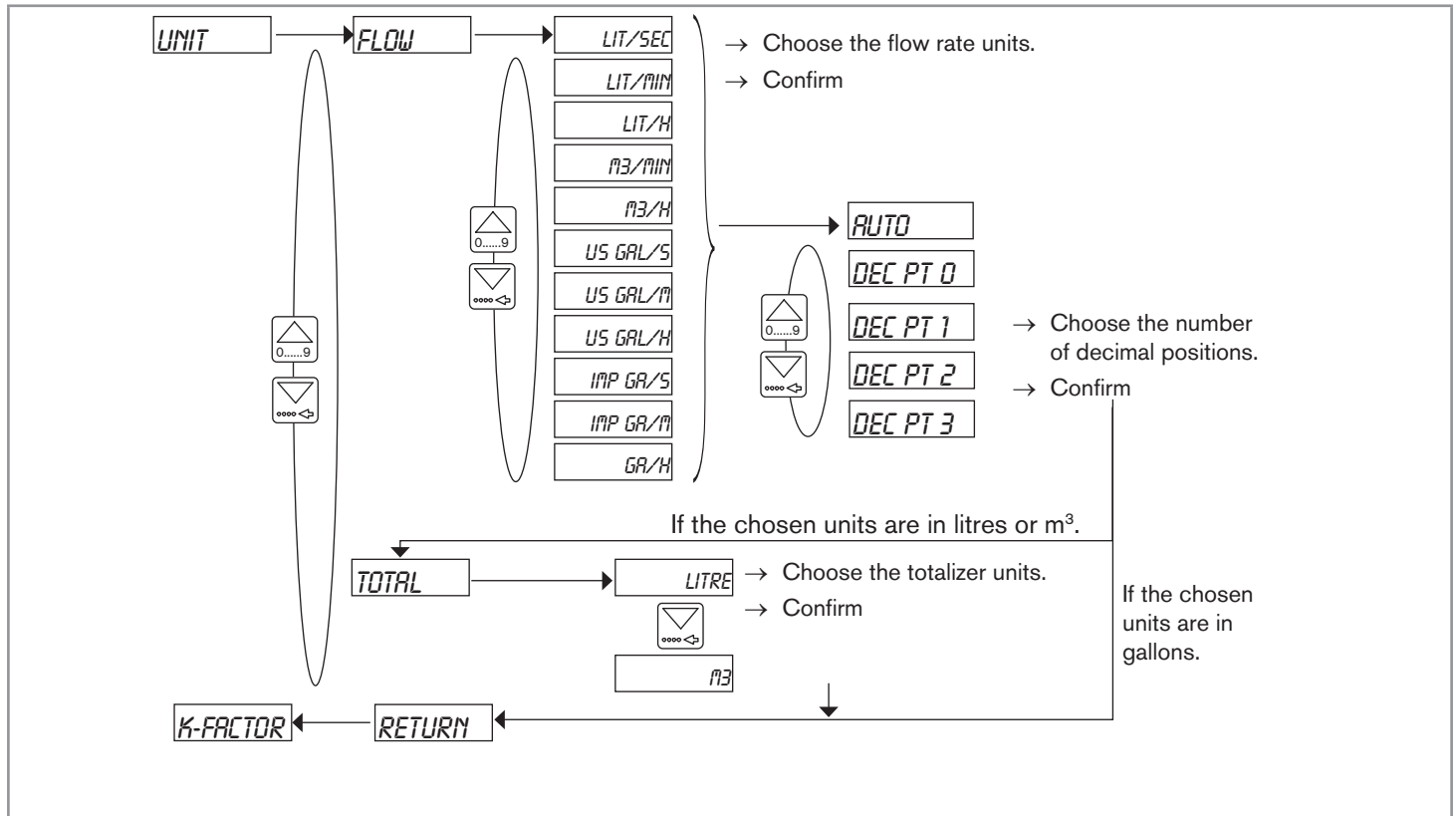

Fig. 17: Diagram of the "UNIT" parameter of the Configuration level

8.7.3. Entering or determining the K factor of the fitting used



The K factor of the fitting used is in the Operating Instructions of the fitting.
Find the Operating Instructions of the Bürkert fittings on the internet at www.burkert.com.

The device determines the flow rate in the pipe using the K factor of the fitting.

The K factor of the fitting used can be entered (see Fig. 18) or calculated through a Teach-in procedure (see chap. 8.7.4).

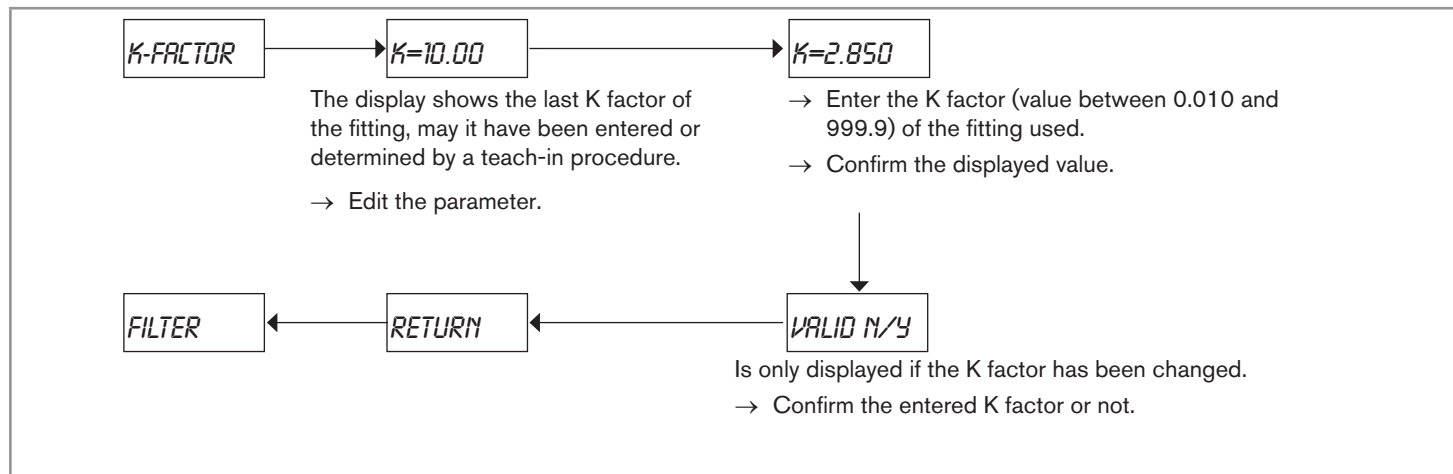

Fig. 18: Entering the K factor of the fitting used

8.7.4. Determining the fitting K factor using a Teach-In procedure

The device determines the flow rate in the pipe using the fitting K factor.

The "TEACH V." or "TEACH F." parameter allows the device to determine the K factor of the fitting with a Teach-In procedure; The K factor may also be directly entered: see chap. [8.7.3](#).

The Teach-in can be done either depending on a known volume ("TEACH V.", see [Fig. 19](#)) or depending on the flow rate in the pipe, which has been measured with a reference instrument ("TEACH F." [Fig. 20](#)).

Calculating the K factor of the fitting with a Teach-In procedure depending on a volume ("TEACH V.")



The device will use the new K factor as soon as "SAVE YES" is confirmed when leaving the Parameters menu.

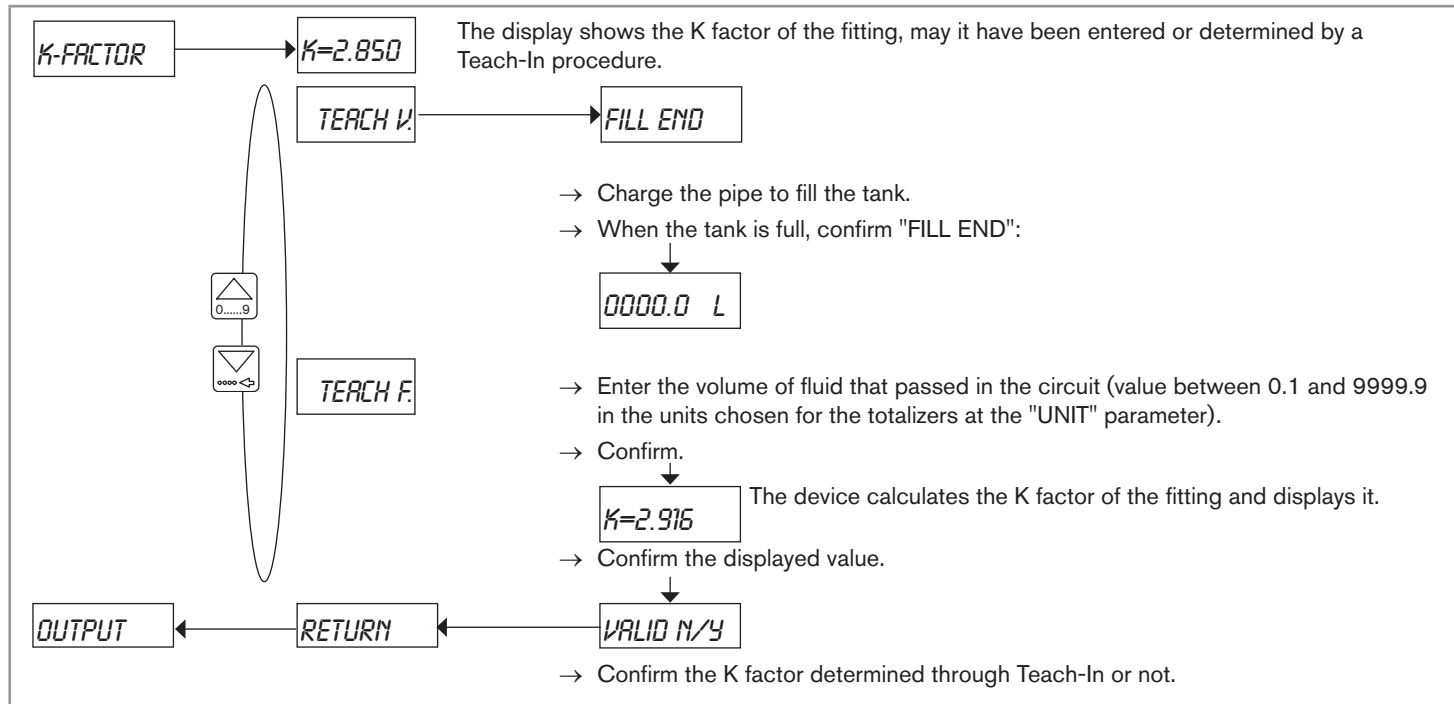

Fig. 19: Teach-in procedure depending on a volume

Calculating the K factor of the fitting with a Teach-In procedure depending on a flow rate ("TEACH F.")



The device will use the new K factor as soon as "SAVE YES" is confirmed when leaving the Parameters menu.

- Charge the pipe.
- Wait for the flow rate to be stable.
- Confirm "TEACH F.": "MEASURE \\" is displayed.

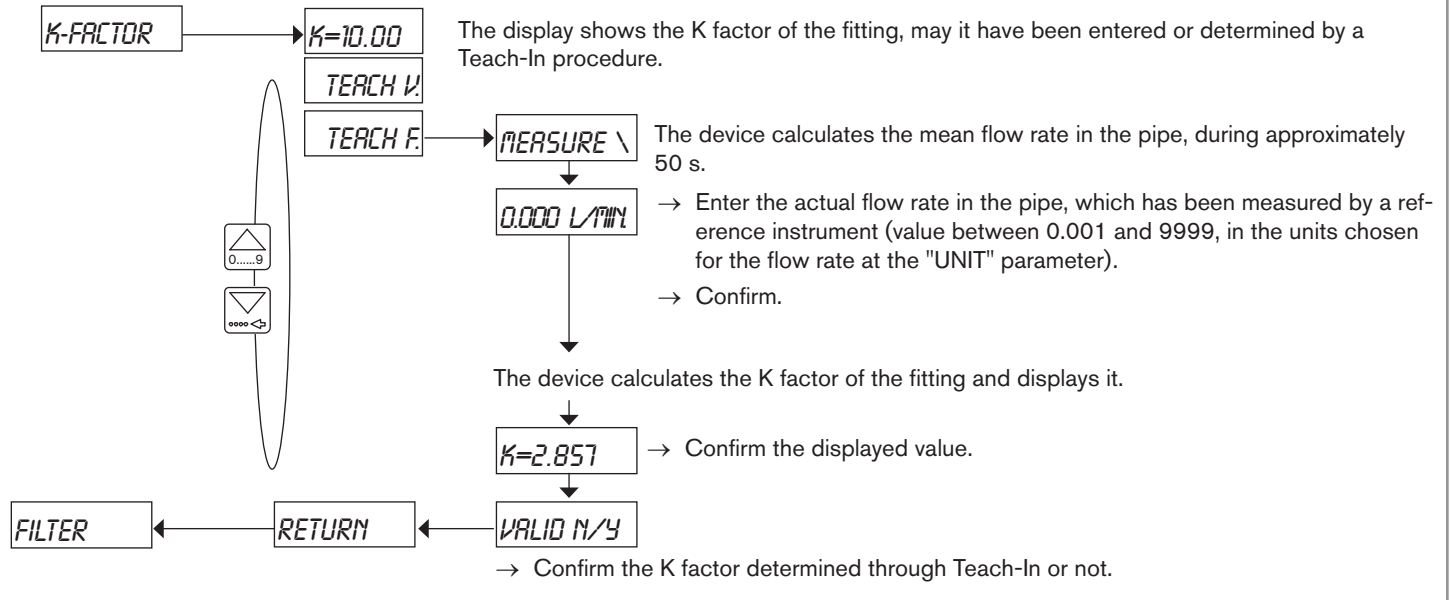

Fig. 20: Teach-In procedure depending on the flow rate

8.7.5. Configuring the filter

This parameter makes it possible to dampen the fluctuations of the displayed flow rate values.

The filtering has no effect on the totalizers.

Ten filters are available.

! When the "fast" filter is active and the flow rate varies for $\pm 30\%$ (for example when charging the pipe or stopping the flow), the filter is disabled: the new flow rate is immediately taken into account by the device.

! If a filter with a high value is chosen, the device does not detect the sudden flow rate changes thus the flow rate in the pipe may strongly defer from the displayed flow rate.

! A sudden stop of the flow is immediately detected whatever filter is active.

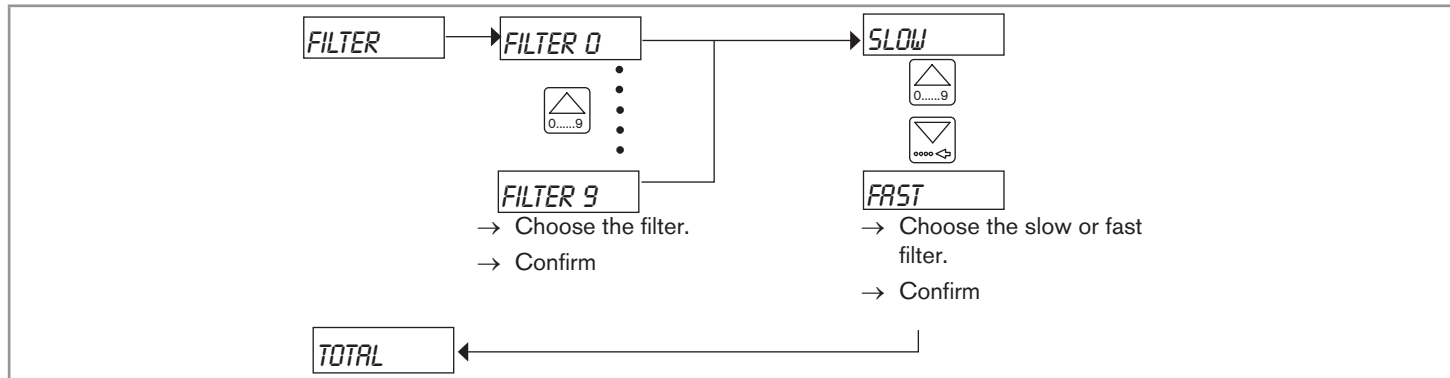

Fig. 21: Diagram of the "FILTER" parameter of the Parameters menu

The following table shows the response times (10 % to 90 %) of the filters:

Filter	Response time
0	0.15 s
1	0.7 s
2	1.4 s
3	2.5 s
4	3.5 s

Filter	Response time
5	6 s
6	10 s
7	19 s
8	33 s
9	50 s

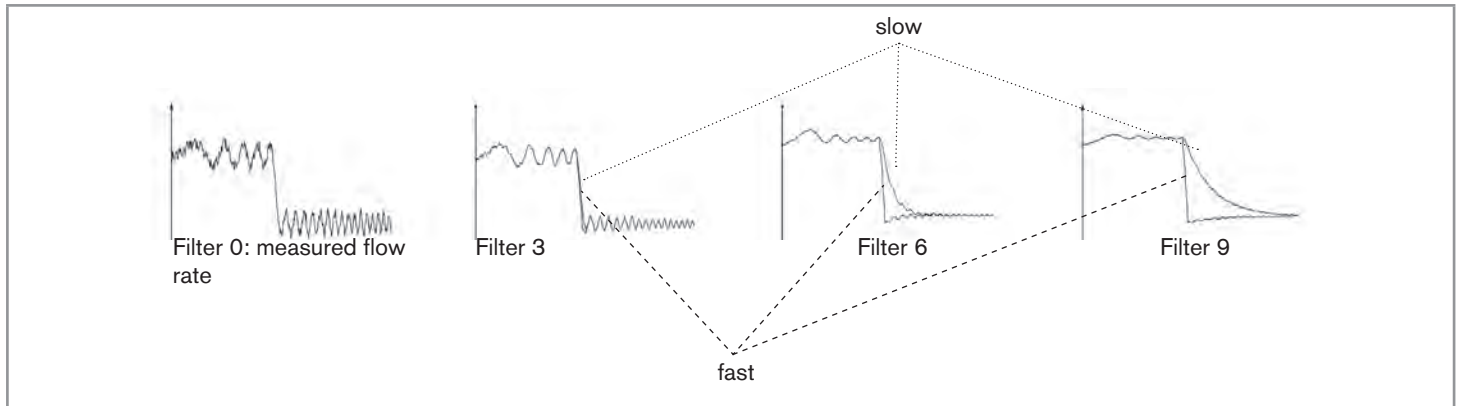



Fig. 22: Available filters

8.7.6. Resetting both totalizers

This parameter makes it possible to reset both totalizers.

 Both totalizers are reset upon confirmation of "SAVE YES" when leaving the Parameters menu.

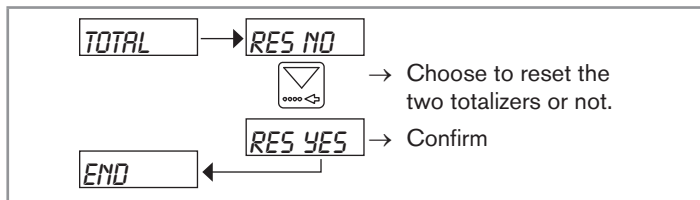



Fig. 23: Diagram of the "TOTAL" parameter of the Parameters menu

 The daily totalizer can be reset from the Process level (see chap. 8.6).

8.8. Details of the Test menu



To access the Test menu, simultaneously press keys for at least 5 s.

This menu comprises the following configurable parameters:

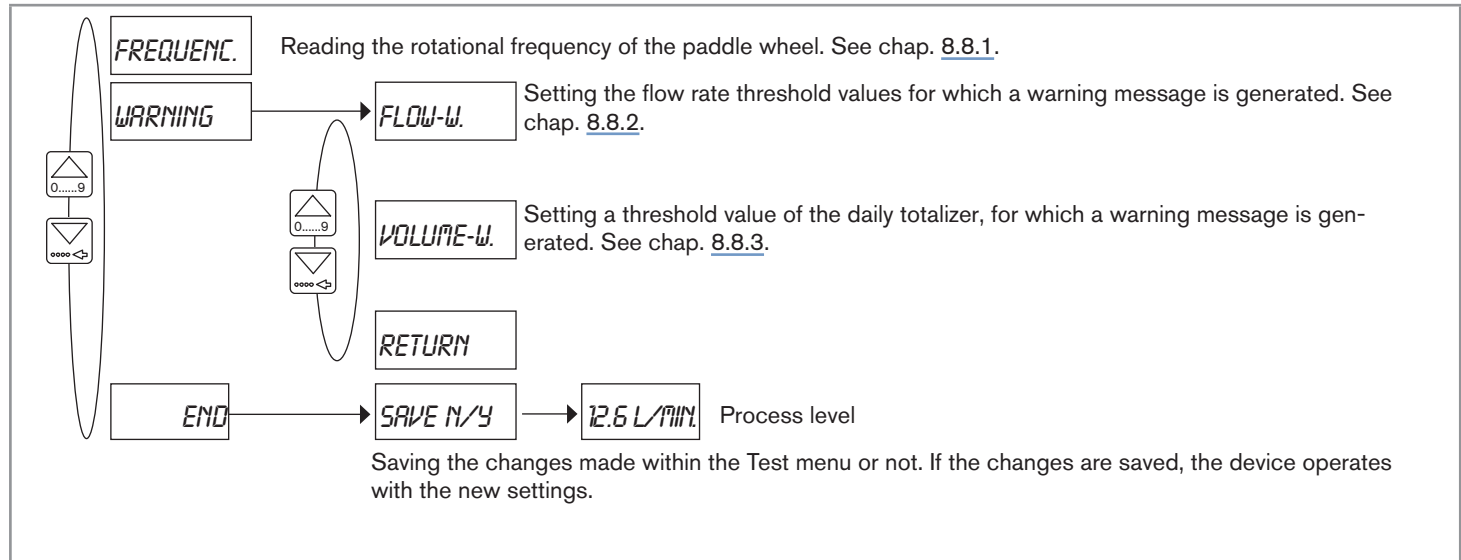

Fig. 24: Diagram of the Test menu

→ If you do not want to adjust another parameter, go to the "END" parameter of the Test menu and press to save the settings or not and go back to the Process level.

8.8.1. Reading the rotational frequency of the paddle wheel

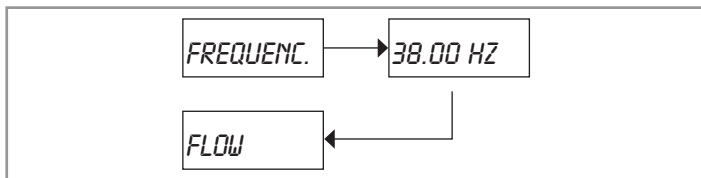

Fig. 25: Diagram of the "FREQUENC." parameter of the Test menu

8.8.2. Monitoring the flow rate in the pipe

A malfunction in your process or of the flow sensor may be indicated either by a flow rate which is too low or too high.

The parameter "FLOW-W." makes it possible to monitor the flow rate.

- To disable the flow rate monitoring, set $W- = W+ = 0$.
- To disable one of the limits, set it to 0.

To be warned when the flow rate is too low or too high, enter the flow rate range (in the units that have been chosen in the "UNIT" parameter of the Parameters menu), outside which the device generates a warning message, "WARN LO" or "WARN HI", and turns the device status LED to orange.

When a warning message, "WARN LO" or "WARN HI", is generated by the device:

- check the process.
- if the process is not faulty, check the flow sensor condition and clean it if necessary.
- if the flow rate measurement is still incorrect, contact the Bürkert retailer.



See also chap. ["9.4. If you encounter problems"](#).

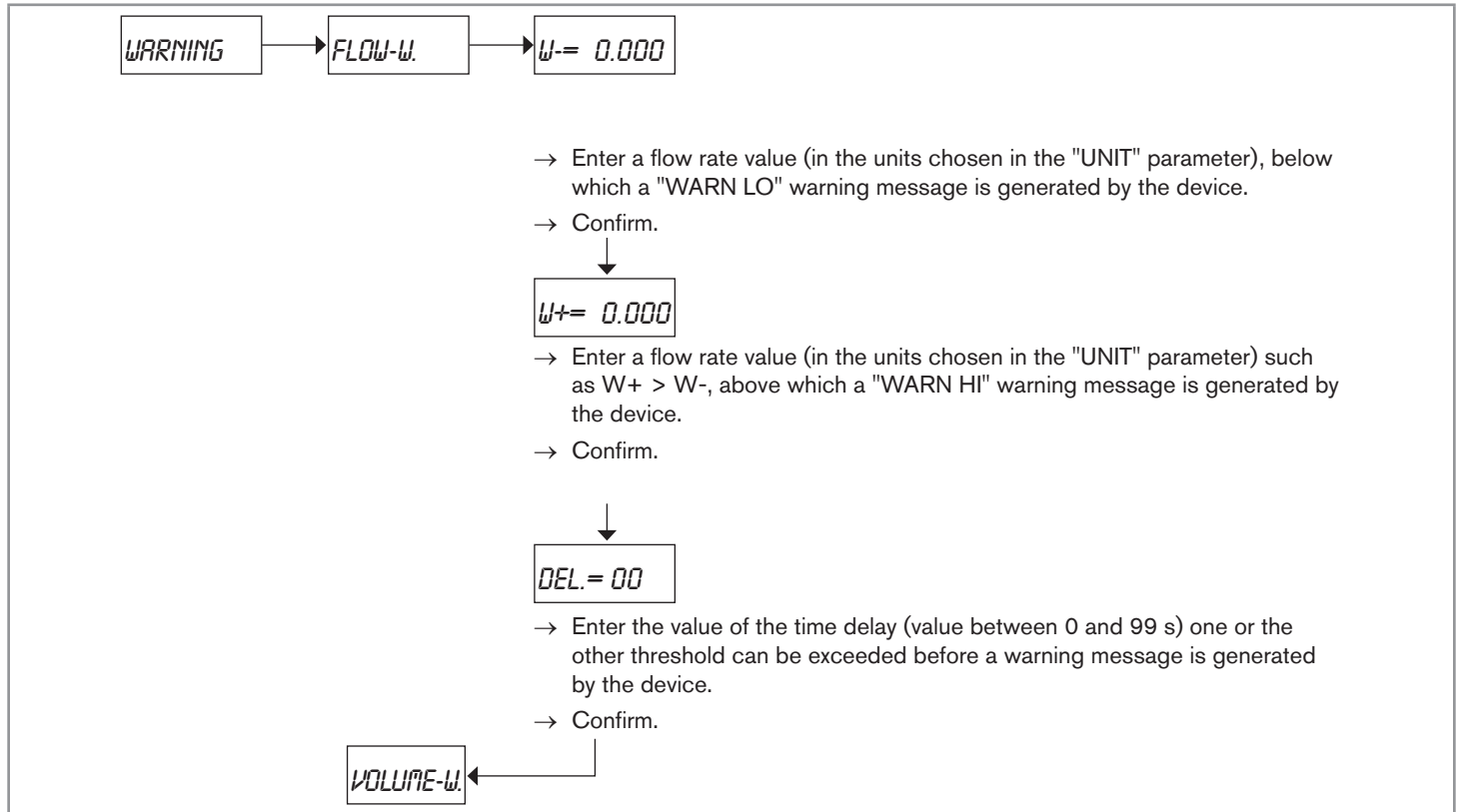

Fig. 26: Diagram of the "FLOW-W." parameter of the Test menu

8.8.3. Monitoring the value of the daily totalizer

The parameter "VOLUME-W." makes it possible to monitor the value of the daily totalizer. When the set value is reached, a warning message is generated by the device.

! To deactivate the monitoring of the totalizer, set "VOLUME-W." to zero.

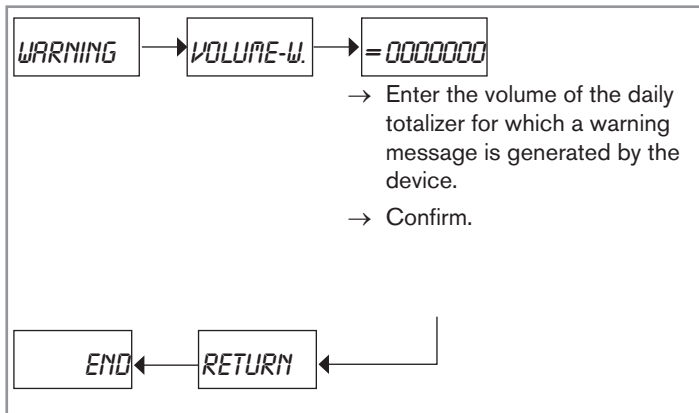



Fig. 27: Diagram of the "VOLUME-W." parameter of the Test menu

When the warning message "WARN. VOL." is sent out (see chap. 9.4.3), reset the totalizer: see chap. 8.7.6.

8.9. Details of the Information menu

! For the meaning of a message, go to chap. 9.4.2 and 9.4.3.

To access the Information menu, press the  key for at least 2 s, in the Process level.

In this menu read the charge of the batteries and the error or warning messages generated by the device.

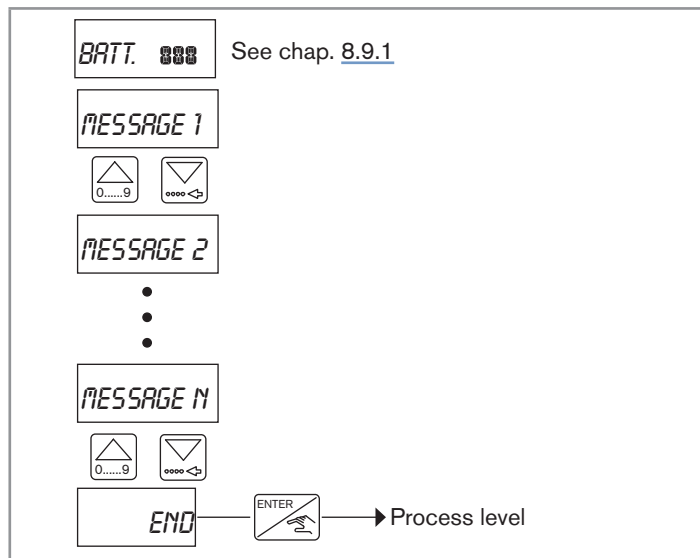

Fig. 28: Diagram of the Information menu

8.9.1. Reading the capacity of the batteries

Display	Available capacity of the batteries
BATT. 888	New batteries - Full capacity
BATT. 88}	Less than 70 % of the full capacity
BATT. 8 }	Less than 30 % of the full capacity
BATT. }	Less than 10 % of the full capacity, replace the batteries immediately

NOTICE

The discharge of the batteries is faster when the status LED is ON.

9. MAINTENANCE AND TROUBLESHOOTING



DANGER

Risk of injury due to high pressure in the installation.

- ▶ Stop the circulation of fluid, cut off the pressure and drain the pipe before loosening the process connections.

Risk of injury due to electrical voltage.

- ▶ Put the power switch to OFF before carrying out work on the device.
- ▶ Observe all applicable accident protection and safety regulations for electrical equipment.

Risk of injury due to high fluid temperatures.

- ▶ Use safety gloves to handle the device.
- ▶ Stop the circulation of fluid and drain the pipe before loosening the process connections.

Risk of injury due to the nature of the fluid.

- ▶ Respect the prevailing regulations on accident prevention and safety relating to the use of aggressive fluids.



WARNING

Risk of injury due to non-conforming maintenance.

- ▶ Maintenance must only be carried out by qualified and skilled staff with the appropriate tools.
- ▶ Ensure that the restart of the installation is controlled after any interventions.

9.1. Cleaning the device

The device can be cleaned with a cloth dampened with water or a detergent compatible with the materials the device is made of.

Please feel free to contact your Bürkert supplier for any additional information.

9.2. Cleaning the flow sensor for the 8025

NOTICE

- ▶ Use a cleaning product that is compatible with the materials the flow sensor is made of.
- ▶ Do not use any abrasive acting materials.

NOTICE

After cleaning of the flow sensor:

- ▶ Rinse the flow sensor.
- ▶ Check the seal and replace it if necessary.

9.3. Replacing the batteries



WARNING

Burn injury due to the leakage of the chemicals from the batteries.

- ▶ If chemicals have leaked out of the batteries, wear gloves to handle the batteries.



WARNING

Burn injury due to the leakage of the chemicals from the batteries if the batteries are exposed to high temperatures.

- ▶ Respect the operating temperature of the batteries.

NOTICE

Risk of burning due to a short-circuit if the red and black wires of the terminal block are disconnected and not insulated.

- ▶ Make sure the wires are insulated when they are disconnected.



Recycle used batteries with respect to the WEEE standard: 2002/96/EC.

Procedure to replace the batteries:

- Open the protective lid.
- Loosen the 4 screws to remove the cover.
- Put the cover down so that the wires connected to the terminal block and the wire which connects the flow sensor to the electronic board are not subject to mechanical stress.
- Put the switch to OFF to switch-off the device.
- Loosen the 2 screws of the protective plate for the batteries.
- Remove the protective plate for the batteries.
- Remove the batteries with a regular screwdriver or an applicable tool.
- Replace the batteries with batteries having the recommended specifications.
- Check that the position of the batteries is correct by putting the power supply switch to ON. If the device goes on, the position of the batteries is correct.
- Screw the protective plate for the batteries.
- Close and screw the cover and the lid.

9.4. If you encounter problems

9.4.1. Resolution of problems when the device status LED is OFF

Problem	Recommended action
The display is OFF.	<ul style="list-style-type: none"> → Make sure that the red and black wires are correctly wired to the terminal block. → Make sure that the power supply switch is put to ON. → Make sure that the batteries are correctly positioned in their housing. → At this time, if the device stays OFF, replace the batteries.
The device does not properly measure the flow rate.	<ul style="list-style-type: none"> → Check that the K factor corresponds to the fitting used. → Carry out a Teach-In procedure to determine the K factor of the fitting used.
The displayed flow rate is not nil but the flow rate in the pipe should be.	<ul style="list-style-type: none"> → Check that the flow rate in the pipe is nil. → Check the filter chosen. See chap. 8.7.5.

Problem	Recommended action
The displayed flow rate is always nil.	<ul style="list-style-type: none"> → Check that the flow rate in the pipe is not nil. → Check that the entered K factor is correct. → Choose a smaller flow rate unit or increase the number of displayed decimals.
The displayed flow rate is not stable.	<ul style="list-style-type: none"> → Check that there is fluid in the pipe. → Choose a higher filter value.
The displayed flow rate changes very slowly.	<ul style="list-style-type: none"> → Check that there is fluid in the pipe. → Choose a lower filter value.
The value of the flow rate or of the totalizer flashes. The device continues to operate.	<ul style="list-style-type: none"> → Plan to replace the batteries

9.4.2. Resolution of problems when the device status LED is red and flashing

Message displayed	Possible cause	Recommended action
"LOW BATT."	<p>The battery power is too low.</p> <p>The device does not function.</p>	<ul style="list-style-type: none"> → Replace the batteries (see chap. 9.3).
"ERROR3"	<p>The user settings are lost.</p> <p>The device measures wrong values.</p>	<ul style="list-style-type: none"> → Start the device again. → If the message persists, configure the device again. → If the problem occurs again, take contact with the retailer.
"ERROR4"	<p>The totalizer values are lost.</p> <p>The values saved upon the next to last power down are retrieved.</p>	<ul style="list-style-type: none"> → Start the device again. → If the problem occurs again, take contact with the retailer.

Message displayed	Possible cause	Recommended action
"ERROR5"	Both "ERROR3" and "ERROR4".	<ul style="list-style-type: none"> → Start the device again. → If the message persists, configure the device again. → If the problem occurs again, take contact with the retailer.
"ERROR6"	Totalizer values definitely lost. Both totalizers are reset.	<ul style="list-style-type: none"> → Start the device again. → If the problem occurs again, take contact with the retailer.
"ERROR7"	Both "ERROR3" and "ERROR6".	<ul style="list-style-type: none"> → Start the device again. → If the message persists, configure the device again. → If the problem occurs again, take contact with the retailer.

Message displayed	Possible cause	Recommended action
"MEAS. OVF"	The rotational frequency of the paddle wheel is higher than 250 Hz.	<ul style="list-style-type: none"> → Check the flow rate in the pipe. → If necessary, adjust the flow rate. → If the problem occurs again, take contact with the retailer.

9.4.3. Resolution of problems linked to warning messages and device status LED is orange and flashing

Message displayed	Possible cause	Recommended action
"WARN. LO"	<p>The measured flow rate has stayed under the minimum threshold for the set time delay.</p> <p>This message appears when the flow rate is monitored (see chap. 8.8.2).</p>	<ul style="list-style-type: none"> → Check the flow rate in the pipe and its consequences on the process. → If necessary, clean the flow sensor.

Message displayed	Possible cause	Recommended action
"WARN. HI"	<p>The measured flow rate has stayed above the maximum threshold for the set time delay.</p> <p>This message appears when the flow rate is monitored (see chap. 8.8.2).</p>	<p>→ Check the flow rate in the pipe and its consequences on the process.</p> <p>→ If necessary, clean the flow sensor.</p>
"WARN. VOL."	<p>The daily totalizer has reached the value set in parameter "VOLUME-W." of the Test menu.</p>	<p>→ Carry out the planned maintenance operation.</p> <p>→ Reset the daily totalizer: see chap. 8.7.6.</p>

10. SPARE PARTS AND ACCESSORIES



CAUTION

Risk of injury and/or damage caused by the use of unsuitable parts.

Incorrect accessories and unsuitable replacement parts may cause injuries and damage the device and the surrounding area.

- ▶ Use only original accessories and original replacement parts from Bürkert.

10.1. Flow transmitter SE35

Spare part	Order code
Cover in PC, with lid, incl. window, screws, sticked foil and electronic card	425433
Set with 8 FLOW foils	553191
Housing incl. coil as a measuring element	425247
Set including: <ul style="list-style-type: none"> ▪ 2 M20x1.5 screw plugs ▪ 2 flat seals 	444705

10.2. Flowmeter 8025

Spare part	Order code
Cover in PC, with lid, incl. window, screws, sticked foil and electronic card	425433
Set with 8 FLOW foils	553191
Set including: <ul style="list-style-type: none"> ▪ 2 M20x1.5 screw plugs ▪ 2 flat seals 	444705
Set including: <ul style="list-style-type: none"> ▪ 1 green FKM seal ▪ 1 black EPDM seal 	552111
Housing with snap ring and nut	552398
Snap ring	619205
Nut	619204
Flow sensor with coil (short sensor) for DN ≤ 100 + replacement instructions	633366
Flow sensor with coil (long sensor) for DN ≥ 100 + replacement instructions	634757

11. PACKAGING, TRANSPORT

NOTICE

Damage due to transport

Transport may damage an insufficiently protected device.

- ▶ Transport the device in shock-resistant packaging and away from humidity and dirt.
- ▶ Do not expose the device to temperatures that may exceed the admissible storage temperature range.

12. STORAGE

NOTICE

Poor storage can damage the device.

- ▶ Store the device in a dry place away from dust.
- ▶ Storage temperature of the device: +10...+25 °C.

13. DISPOSAL OF THE DEVICE

→ Dispose of the device and its packaging in an environmentally-friendly way.

NOTICE

Damage to the environment caused by parts contaminated by fluids.

- ▶ Keep to the existing provisions on the subject of waste disposal and environmental protection.

www.burkert.com