

Type 0127

Rocker valve

2/2 or 3/2-way solenoid valve
2/2 oder 3/2-Wege Magnetventil
Vanne magnétique 2/2 ou 3/2



Operating Instructions

Bedienungsanleitung
Manuel d'utilisation

Contents

1	Operating Instructions	2
2	Intended use	3
3	Basic safety instructions	3
4	Modularity	4
5	Technical Data	5
6	Installation	7
7	Maintenance / Malfunctions	11
8	Replacement parts	11
9	Transport, Storage, Disposal	11

1 OPERATING INSTRUCTIONS

The operating instructions contain important information.

- ▶ Read the instructions carefully and follow the safety instructions in particular, and also observe the operating conditions.
- ▶ Instructions must be available to each user.
- ▶ The liability and warranty for Type 0127 are void if the operating instructions are not followed.

1.1 Symbols

→ designates a procedure which you must carry out.

- ▶ Designates an instruction to prevent risks.

Warning of injuries:



DANGER!

Imminent danger. Serious or fatal injuries.



WARNING!

Potential danger. Serious or fatal injuries.



CAUTION!

Danger. Minor or moderately severe injuries.

Warns of damage to property:

NOTE!

2 INTENDED USE

Valve Type 127 has been designed as a rocker solenoid valve with isolating diaphragm.

It is suitable for laboratory, medical and analysis technology

- ▶ Use according to the authorized data, operating conditions, and conditions of use specified in the contract documents and operating instructions.
- ▶ The valve must not be used outdoors.
- ▶ Use the device only in conjunction with third-party devices and components recommended and authorized by Bürkert.
- ▶ Use device only when in perfect condition and always ensure proper storage, transportation, installation and operation.
- ▶ Use the device only as intended.

2.1 Definition of term

The term “device” used in these instructions always stands for the flipper solenoid valve type 0127.

3 BASIC SAFETY INSTRUCTIONS

These safety instructions do not make allowance for any contingencies and events which may arise during installation, operation and maintenance.



Danger – high pressure.

- ▶ Before loosening the lines and valves, turn off the pressure and vent the lines.

Risk of injury due to electric shock.

- ▶ Before working on the system or device, switch off the power supply and secure to prevent reactivation.
- ▶ Observe applicable accident prevention and safety regulations for electrical equipment.

Risk of burns/risk of fire if used continuously through hot device surface.

- ▶ Keep the device away from highly flammable substances and media and do not touch with bare hands.

Leaking medium when the diaphragm is worn.

- ▶ Regularly check for leaking medium.
- ▶ If the media is hazardous, protect the environment from danger.

General hazardous situations.

To prevent injuries:

- ▶ Do not make any internal or external changes on the device and do not subject it to mechanical stress.
- ▶ Secure to prevent unintentional actuation.
- ▶ Only trained technicians may perform installation and maintenance work.
- ▶ The valves must be installed in accordance with the regulations applicable in the country.
- ▶ After an interruption in the power supply, ensure that the process is restarted in a controlled manner.
- ▶ Observe the general rules of technology.

NOTE!

Electrostatic sensitive components / modules.

The power reduction electronics, which is available as an accessory, contains electronic components which react sensitively to electrostatic discharge (ESD). Contact with electrostatically charged persons or objects is hazardous to these components. In the worst case scenario, they will be destroyed immediately or will fail after start-up.

- Observe the requirements in accordance with EN 61340-5-1 and 5-2 to minimize or avoid the possibility of damage caused by a sudden electrostatic discharge.
- Do not touch live electronic components.

4 MODULARITY

The valve is modular in design and can be supplied with different line connections according to the application case. It can be used individually and in blocks.

5 TECHNICAL DATA

5.1 Operating Conditions



WARNING!

Risk of injury.

Malfunction if used outside.

- ▶ Do not use Type 0127 outside and avoid heat sources which may cause the permitted temperature range to be exceeded.

Ambient temperature 0 ... +55 °C

Medium temperature

Nominal width	Seal material	Temperature range
DN 0,8	FFKM	+5...+50 °C
DN 0,8	FKM	0...+50 °C
DN 0,8	EPDM	-5...+50 °C
DN 1,2 und 1,6	FFKM	+10...+50 °C
DN 1,2 und 1,6	FKM	+5...+50 °C
DN 1,2 und 1,6	EPDM	-5...+50 °C

Media neutral and aggressive liquids and gases which do not corrode the housings and seal materials (see resistance table at www.burkert.com → Type)

Protection class IP54 with wires and individual device socket
IP20 with multi-device socket

5.2 Conformity

The solenoid valve Type 0127 conforms to the EU directives according to the EU Declaration of Conformity (if applicable).

5.3 Standards

The applied standards, which are used to demonstrate compliance with the EU Directives, are listed in the EU type test certificate and/or the EU Declaration of Conformity (if applicable).

5.4 Mechanical Data

Dimensions see data sheet
Housing material PVDF, ETFE, PEEK, PPS
Sealing material FFKM, FKM, EPDM

5.5 Pneumatic Data

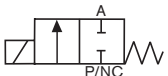
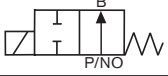
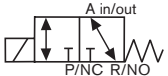
Operating principles	
A	 <p>2/2-way valve, direct action, closed with no current</p>
B	 <p>2/2-way valve, direct action, opened with no current</p>
T	 <p>3/2-way valve, direct-acting, all-purpose</p>

Pressure range	see type label
Line connections	Threaded connection G1/8, NPT1/8 or UNF1/4-28 Flanged connection Hose connection

! Note the information specified on the rating plate for voltage, type of current, and pressure.

5.5.1 Rating plate (example)

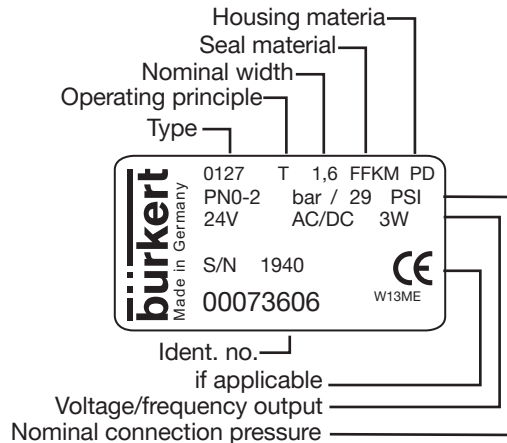

5.6 Electrical Data

Operating voltage 12 V DC
 24 V DC
 24 V UC

Voltage tolerance $\pm 10 \%$

Nominal power
12-24 V 3.0 W

Nominal operating mode Long-term operation,
 duty cycle 100 %
for block assembly if temperatures of media or
 surrounding area above +40 °C:
 intermittent duty 40% (10 min)



Note the information specified on the rating plate for voltage, type of current, and pressure.

6 INSTALLATION

6.1 Safety Instructions



WARNING!

Risk of injury when installing the valve.

- ▶ This work may be carried out by authorised technicians only and with the appropriate tools.
- ▶ After an interruption in the power supply or pneumatic supply, ensure that the process is restarted in a defined or controlled manner.

6.2 Fluid Installation



DANGER!

Danger – high pressure.

Danger of severe injuries from reaching into the system.

- ▶ Before loosening the lines and valves, turn off the pressure and vent the lines.

Installation position: any position, preferably with the drive facing up.

Installation

→ Before installation, clean any possible dirt off the pipelines and flange connections.

→ If required, install a dirt trap to prevent malfunctions.

Mesh size: 5 µm



Observe the direction of flow of the valve.

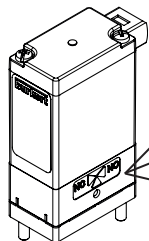

Operating principle*

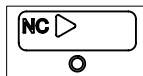

A

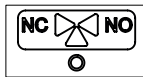

T

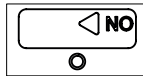

B

* see also the description of the operating principles in the chapter entitled "Pneumatic Data"

Identification of the valve connections on the housing:

NO Normally Open Connection normally open for WWB

NC Normally Closed Connection normally closed, for WWA

IN/OUT for pressure connection (distributor) or work connection (mixer), for WWT



The valve housing must not be twisted by the fastening screws or by screwing in the connecting nipples too far.

The housings with threaded or hose connection have fixing eyelets for the screw connection from above with M3 and from below with self-tapping screws BZ 3.9 x ... DIN 7971.

Housing with threaded connection:

→ Use PTFE tape as sealing material

→ Screw in the connecting thread by hand only

Housing with hose connection:

→ Use flexible silicone or FKM hose with 1.6-2 mm inner diameter

Valve with flanged connection:

→ Remove the locking plate (coloured orange).



Do not remove the flanged plate.



WARNING!

Danger – escaping medium.

Leaking connections if seals not seated properly, if connection plate uneven or if surface quality of the connection plate inadequate.

- ▶ Make certain the seals included with delivery are properly seated in the valve.
- ▶ Ensure that the connection plate is even.
- ▶ Ensure that the surface quality of the connection plate is adequate.

→ Insert the seal into the valve.

CAUTION!

If the tightening torque is too great, the device may be damaged.

- ▶ Observe the max. tightening torque of the screws.

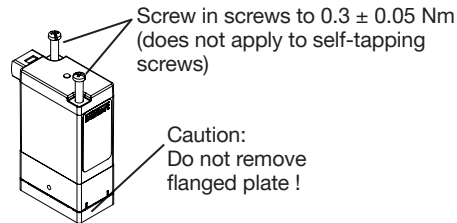

→ Attach valve to the connection plate.

Dimensional drawing for connection plate:

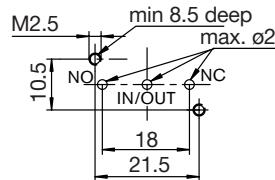

Arrangement of the bores:

3-way	2-way central exit	2-way external exit

6.3 Electrical Installation



DANGER!

Risk of electric shock when reaching into the equipment.

- ▶ Before starting work, always switch off the power supply and safeguard to prevent re-activation.
- ▶ Observe applicable accident prevention and safety regulations for electrical equipment.



Note the voltage and current type as specified on the rating plate.

Voltage tolerance $\pm 10\%$

Connection to device socket:



DANGER!

Risk of electric shock if protective conductor not connected.

- ▶ Always connect protective conductor.

Earthing connection (if fitted): Middle plug tab



Ensure that the flat seal is seated correctly for the electrical connection to the device socket.

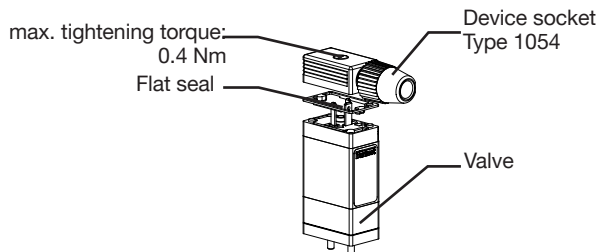

CAUTION!

If the tightening torque is too great, the device may be damaged.

- ▶ Observe the max. tightening torque of the screw.

→ Screw device socket to valve to a max. tightening torque of 0.4 Nm.

Alternative electrical connection:

Two individual wires

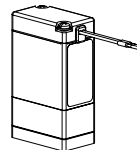

7 MAINTENANCE / MALFUNCTIONS

→ Regularly check for leaking medium.

7.1 Malfunctions

If malfunctions occur, check

- the line connections
- the operating pressure
- the power supply and valve control.

If the valve still does not switch, please contact your Bürkert Service.

8 REPLACEMENT PARTS



CAUTION!

Using the wrong accessories or replacement parts may be dangerous.

Incorrect accessories and spare parts may cause injuries and damage the device and the surrounding area.

- ▶ Use only original accessories and original spare parts supplied by Bürkert.

Accessories and replacement parts available on request.

9 TRANSPORT, STORAGE, DISPOSAL

NOTE!

Transport damages.

Inadequately protected equipment may be damaged during transport.

- ▶ During transportation protect the device against wet and dirt in shock-resistant packaging.
- ▶ Avoid exceeding or dropping below the permitted storage temperature.

Incorrect storage may damage the device.

- ▶ Store the device in a dry and dust-free location.
- ▶ Storage temperature: -40...65 °C.

Damage to the environment caused by device components contaminated with media.

- ▶ Observe applicable regulations on disposal and the environment.
- ▶ Observe national waste disposal regulations.

Bürkert Fluid Control Systems
Sales Center
Christian-Bürkert-Str. 13-17
D-74653 Ingelfingen
Tel. + 49 (0) 7940 - 10 91 111
Fax + 49 (0) 7940 - 10 91 448
E-mail: info@burkert.com

International address

www.burkert.com

Manuals and data sheets on the Internet: www.burkert.com
Bedienungsanleitungen und Datenblätter im Internet: www.buerkert.de
Manuels d'utilisation et fiches techniques sur Internet : www.burkert.fr

© Bürkert Werke GmbH & Co. KG, 2015 - 2019
Operating Instructions 1903/07_EU-ML_00893191 / Original DE

www.burkert.com