

Type bÜS

Bürkert System Bus



Design Guideline

We reserve the right to make technical changes without notice.

© Bürkert Werke GmbH & Co. KG, 2020

Operating Instructions 2012/00_EU-EN 00815392 / Original EN









CONTENTS

1	Symbols used	6
2	Introduction	7
2.1	Preface	7
2.2	What is the Bürkert system bus (bÜS/EDIP)?	7
2.3	For whom is this Design Guideline intended?	7
2.4	What is the purpose of the Design Guideline?	7
2.5	Bürkert quality standard	7
3	Creating a rough project plan	8
3.1	Block diagram, devices, position, protocols	8
4	Getting to know the basics of a bÜS infrastructure – accessories, cables, pin assignment	9
4.1	What is the purpose of the various accessories	9
4.2	Accessories	9
4.2.1	Y-connector	9
4.2.2	Passive junction box	10
4.2.3	Gender changer	10
4.2.4	Termination	11
4.3	Cable configuration	11
4.3.1	Connecting cables	11
4.3.2	Extension cables	11
4.4	Pin assignment	12
4.4.1	M12 connector male, 5-pin (A-coded)	12
4.4.2	M12 connector male, 8-pin (A-coded)	12
4.4.3	Terminal block, 5-pin	12
4.4.4	Terminal block, 4-pin	13
5	Getting to know the bÜS topologies	14
5.1	What is a bus topology and why do you need it?	14
5.2	Common terms of bus topology	14
5.2.1	Trunk line	14
5.2.2	Stub line	14
5.2.3	Overview of cable lengths	14
5.2.4	Example	14
5.3	Which topologies are recommended?	15
5.3.1	Line topology (daisy chain)	15
5.3.2	Line topology with stub lines	15
5.3.3	Star topology	16
5.4	Which topologies are NOT recommended?	16
5.4.1	Tree topology	16
5.5	Which topologies are NOT permitted	17
5.5.1	Ring topology	17
6	Detailed project plan 1	18
6.1	Floor plan	18
6.1.1	Network with a junction box	18
6.1.2	Network with Y-connectors	18

6.1.3	Mixed network	19
7	Technical know-how	20
7.1	Termination resistors	20
7.2	Connection for diagnostics	20
8	Detailed project plan 2	21
8.1	Completion – floor plan	21
8.1.1	Network with a junction box	21
8.1.2	Network with Y-connectors	21
8.1.3	Mixed network	22
9	Network power supply	23
9.1	Power segments	23
9.1.1	One power segment	23
9.1.2	Additional power supply	23
9.2	Rule of thumb	23
10	Detailed project plan 3	24
10.1	Cabling plan	24
10.1.1	Network with junction box	24
10.1.2	Network with Y-connectors	24
10.1.3	Mixed network	25
11	Best practice instructions	26
11.1	Termination resistor	26
11.2	Signal reflections	26
11.3	Passive junction box	26
11.4	Diagnostic port	26
11.5	Baud rate	26
11.6	büS stick	26
11.7	Stub lines	26
11.8	Bus load	26
11.9	Power consumption	27
11.10	Grounding power supplies	27
12	büS networks with maximum network expansion	28
12.1	Line topology	28
12.1.1	500 kbit/s	28
12.1.2	250 kbit/s	29
12.1.3	125 kbit/s	30
12.2	Star topology with a junction box	31
12.3	Tree topology with a junction box	31
13	Troubleshooting	32
13.1	Sporadic disconnections	32
13.2	Red LED (failure)	32
13.3	Orange LED on the device (functional check)	32

13.4	Yellow LED on the device (out of specification)	33
13.5	Blue LED on the device (maintenance required)	33
13.6	Restarting some devices	34
14	Appendix.....	35
14.1	Accessories - büS stick interface sets	35
14.2	Accessories - connectors.....	35
14.3	Accessories - cables (open leads).....	35
14.4	Accessories - extension cables.....	36
14.5	Accessories - power supplies	36
14.6	Accessories - power cables	36

1 SYMBOLS USED

-  Trunk line
-  Stub line
-  Y-connector
-  Y-connector with interrupt
-  Termination resistor
-  Power supply
-  Measurement point
-  Diagnostics

2 INTRODUCTION

2.1 Preface

The aim of this Design Guideline is to provide you with practical information on how to plan your automation plant using Bürkert devices based on the Bürkert system bus (büS). The various aspects involved in the planning, assembly and operation processes are all considered. The structure of the Design Guideline helps you build knowledge and apply it through different steps based on examples.

2.2 What is the Bürkert system bus (büS/EDIP)?

The Bürkert system bus, also referred to as büS, is based on the widely spread CANopen standard and is fully downwards compatible to this standard. The büS concept does not require a master. Field devices can easily interchange process data and detailed diagnostic data. A gateway allows access to this information from a higher-level system. The Bürkert digital device platform EDIP (Efficient Device Integration Platform) opens the door to endless possibilities for a digital future.

2.3 For whom is this Design Guideline intended?

The Design Guideline is intended for engineers or plant builders who are familiar with the planning and engineering of automation plants containing fieldbuses, especially CAN-based protocols like CANopen and DeviceNet. The Design Guideline summarises the additional knowledge required to plan büS/EDIP networks. The most important steps for planning, creating and commissioning büS devices are outlined herein.

2.4 What is the purpose of the Design Guideline?

The Design Guideline aids the planning of a büS/EDIP system. In a comprehensive approach based on illustrative and practical examples, the Design Guideline walks you through the Do's & Don'ts to ensure a fully functional system.

This Design Guideline explains in detailed individual steps how to plan a büS network.

2.5 Bürkert quality standard

All devices with a büS/EDIP interface have to obtain an internal certification which consists of a software and hardware measurement. Therefore, we can ensure that all Bürkert devices have attained the same quality standard. Currently, there are two approved CAN transceivers that meet these requirements.

3 CREATING A ROUGH PROJECT PLAN

3.1 Block diagram, devices, position, protocols

Which devices are planned?

Create an overview of the positioning of your devices.

Are the devices distributed in an equidistant or a non-equidistant manner?

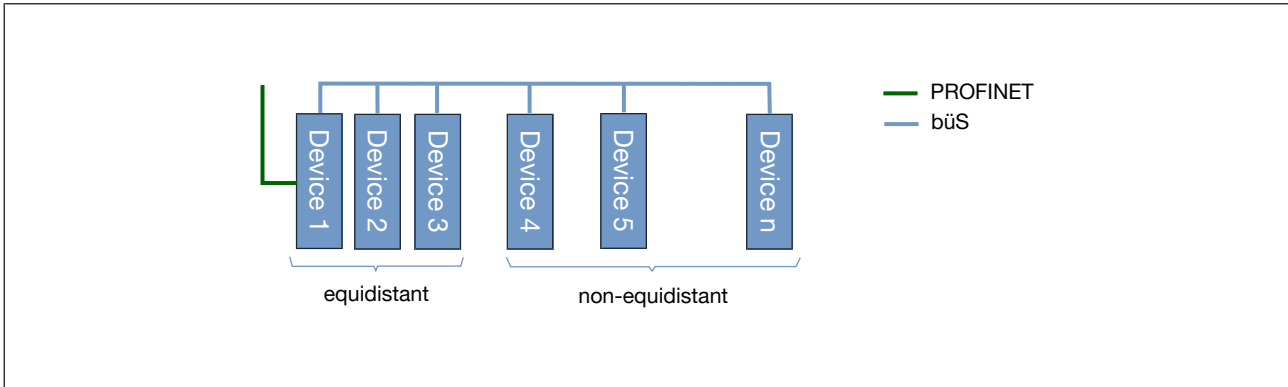

Fig. 1: Project plan

4 GETTING TO KNOW THE BASICS OF A BÜS INFRASTRUCTURE – ACCESSORIES, CABLES, PIN ASSIGNMENT

4.1 What is the purpose of the various accessories

In this chapter, the various components required for cabling are explained in detail.

bÜS devices are widely equipped with standard M12 connectors and. different accessories are available for a range of cabling tasks.

4.2 Accessories

4.2.1 Y-connector

Definition: A Y-connector has three M12 connectors in total. On one side of the connector, there is one male and one female connector. On the other side, there is one female connector.

Purpose: Since most bÜS devices have a single M12 bÜS connector, the Y-connector enables another connection option to the next device. The single connector side is connected to the device and the other two connectors may be used for the devices to the left and the right.

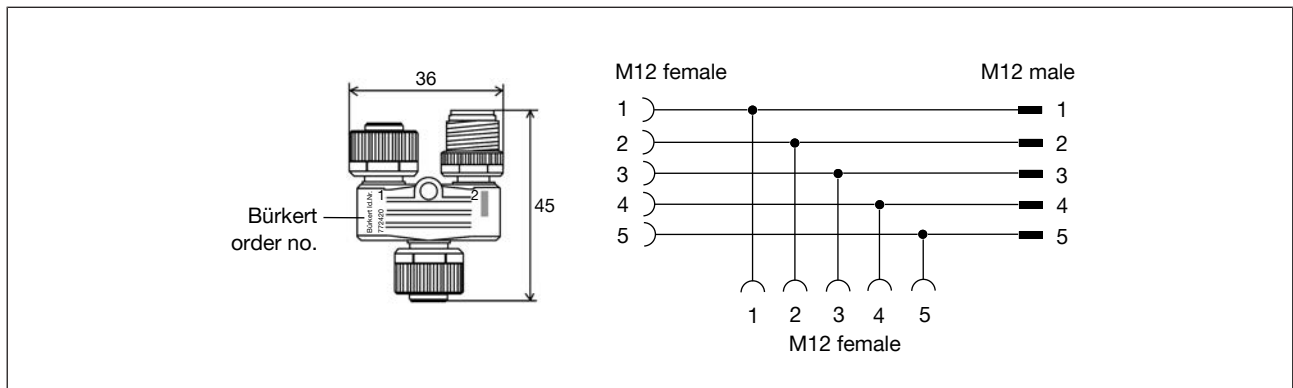

Fig. 2: Y-connector

A Y-connector with interrupt is also available. This connector is used for segmenting power. The pin 2 connection is interrupted. It is therefore possible to use a new power supply for the next bÜS segment if the limit of 100 W has been reached.

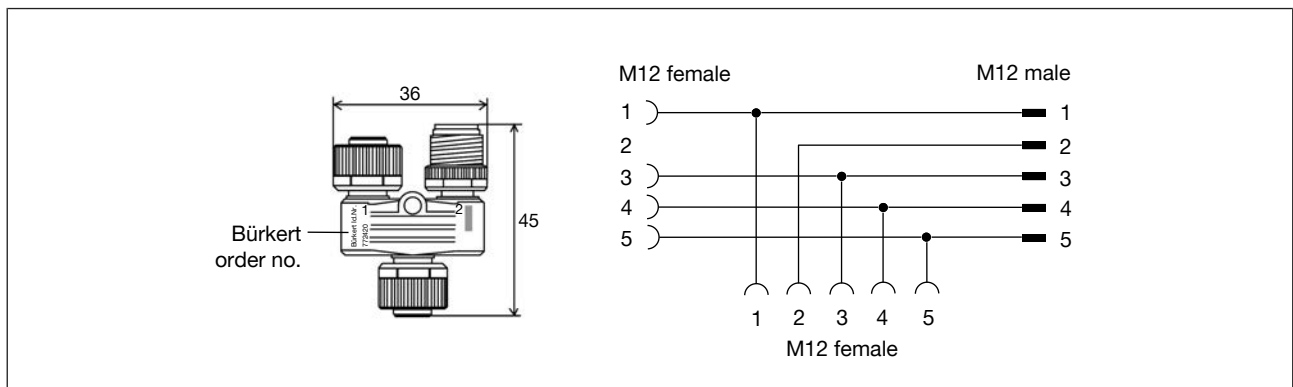

Fig. 3: Y-Connector with interrupt

4.2.2 Passive junction box

Definition: A passive junction box is an IP65/IP67 block with connectors for the power supply and multiple büS connectors. It is a passive module and, therefore, does not have to be configured.

Purpose: The passive junction box allows multiple connections to büS devices in a star form. The Y-connectors on each device become redundant when using a passive junction box, thus making cabling in the field much simpler.



Fig. 4: Passive junction box

4.2.3 Gender changer

Definition: A gender changer is an IP65/67 component with two male M12 connectors.

Purpose: It is used to connect two female M12 connectors.

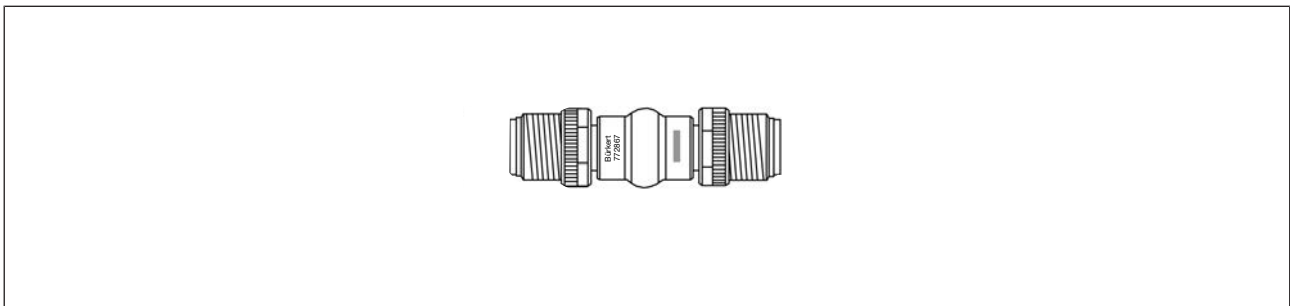

Fig. 5: Gender changer

4.2.4 Termination

Definition: A termination resistor is available as an M12 connector (female and male) or as a chip and has to be used twice in one network.

Purpose: To avoid signal reflections in the cable, the bÜS network always needs to be terminated with two 120 Ω resistors at the ends of the cable. One is required at the beginning of the network and one at the end.

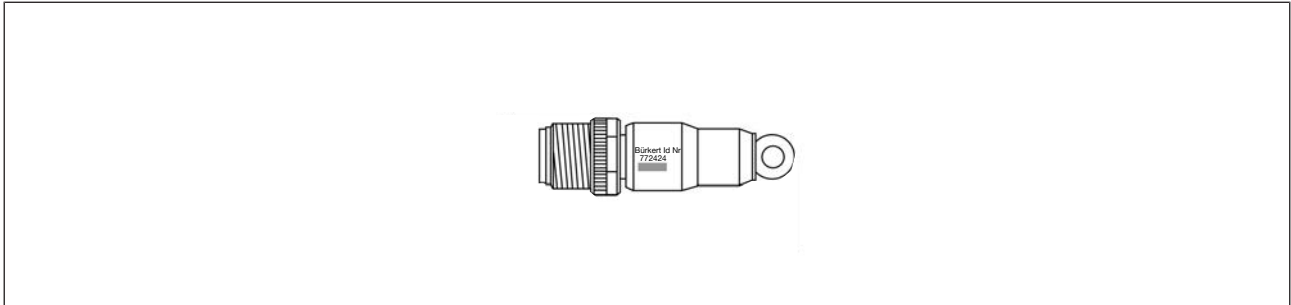

Fig. 6: Termination

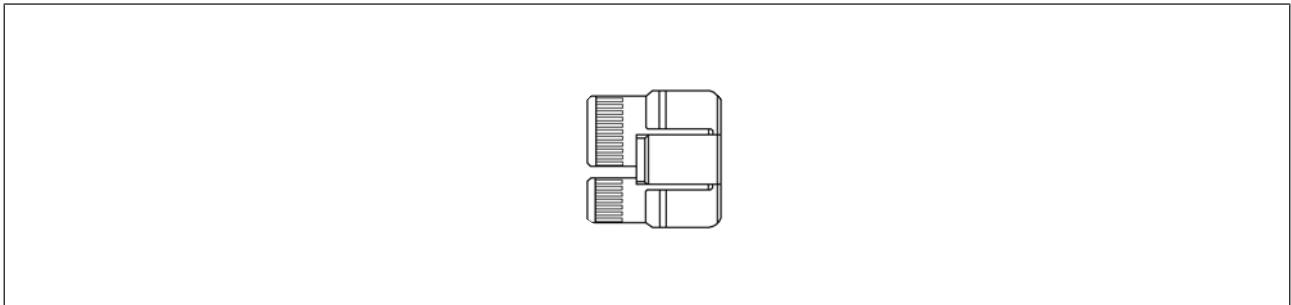

Fig. 7: Termination resistor chip

4.3 Cable configuration

There are two types of cable: connecting cables and extension cables. All cables are available with different cable lengths. An overview can be found in the appendix.

4.3.1 Connecting cables

Definition: Connecting cables are equipped with a female M12 connector on one side and with open leads on the other.

Purpose: These cables connect a device with a terminal block to an M12 connector, e.g. gateway Type ME43.

4.3.2 Extension cables

Definition: Extension cables are equipped with a female M12 connector on one side and with a male M12 connector on the other.

Purpose: These cables are used to connect a device with an M12 connector.

4.4 Pin assignment

Various standard connectors are available for Bürkert devices with a bÜS interface.

4.4.1 M12 connector male, 5-pin (A-coded)

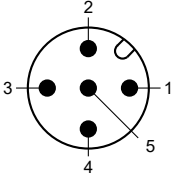
M12 connector male, 5-pin (A-coded)	Pin	Assignment
	1	SHIELD
	2	V+
	3	DGND
	4	CAN_H
	5	CAN_L

Tab. 1: M12 connector male, 5-pin (A-coded)

4.4.2 M12 connector male, 8-pin (A-coded)

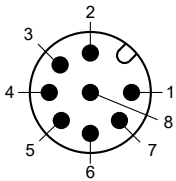
M12 connector male, 8-pin (A-coded)	Pin	Assignment
	1	V+
	2	DGND
	3	CAN_L
	4	CAN_H
	5	Device specific
	6	Device specific
	7	Device specific
	8	Device specific

Tab. 2: M12 connector male, 8-pin (A-coded)

4.4.3 Terminal block, 5-pin

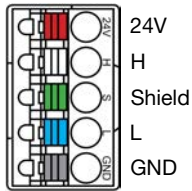
Terminal block, 5-pin	Pin (colour)	Assignment
	Red	24 V DC
	White	CAN_H (bÜS-connection)
	Green	SHIELD
	Blue	CAN_L (bÜS-connection)
	Black	GND

Tab. 3: Terminal block, 5-pin

4.4.4 Terminal block, 4-pin

Terminal block, 4-pin	Pin	Assignment
	1	DGND
	2	CAN_L
	3	CAN_H
	4	+24 V DC

Tab. 4: Terminal block, 4-pin

5 GETTING TO KNOW THE BÜS TOPOLOGIES

5.1 What is a bus topology and why do you need it?

The arrangement of different devices on the bus defines the topology. Different topologies influence the quality of communication and certain topologies are, therefore, recommended to achieve a good network design.

5.2 Common terms of bus topology

5.2.1 Trunk line

A trunk line is the main part of a CANopen cabling solution. All devices and junction boxes are connected to it.

5.2.2 Stub line

A stub line is a branch of the trunk line and allows connection to a device that is not located close to the trunk line. The use of stub lines must be avoided as much as possible. However, there are several limitations depending on the baud rate of the network.

5.2.3 Overview of cable lengths

Overview of maximum cable lengths in the CANopen specification:

Baud rate	max. trunk length	max. stub line length	max. length all stubs
50 kbit/s	1000 m	50 m	250 m
125 kbit/s	500 m	20 m	100 m
250 kbit/s	250 m	10 m	50 m
500 kbit/s	100 m	5 m	25 m
1 Mbit/s	20 m	1 m	5 m

Tab. 5: Cable lengths

This table shows an overview of theoretical values for an ideal network. Nevertheless, there are more dependencies regarding the trunk line length, the stub line length, the amount of process data and the baud rate.

5.2.4 Example

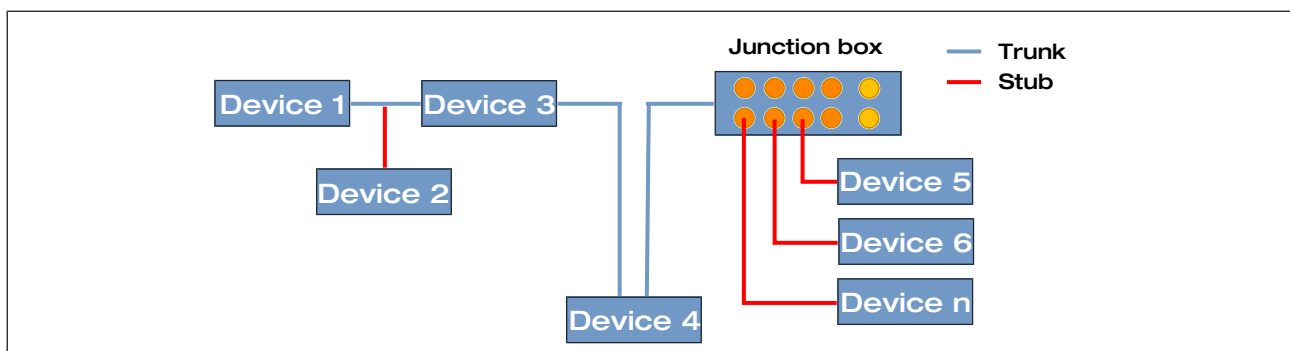

Fig. 8: Example

5.3 Which topologies are recommended?

The following topologies achieve the best results with regard to signal quality.

5.3.1 Line topology (daisy chain)

All devices are connected in single row without a stub line.

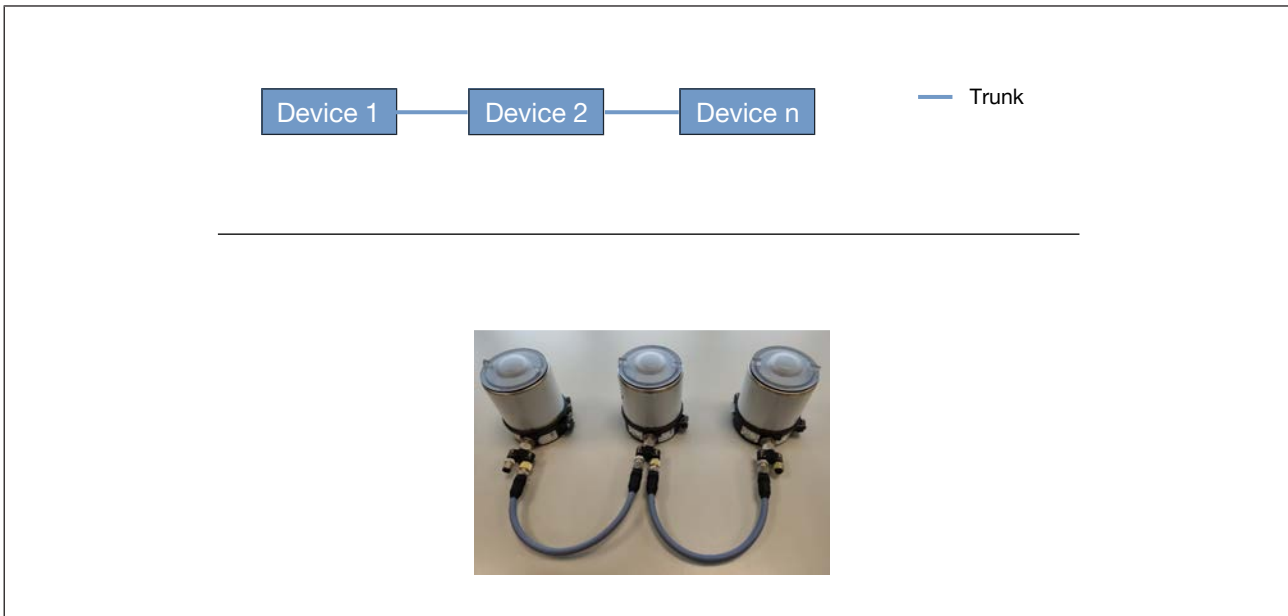

Fig. 9: Line topology

5.3.2 Line topology with stub lines

The trunk line of the network is connected directly to the next device. If this is not possible, use a stub line. Avoid stub lines as much as possible and keep them short. Please note the maximum stub line length that depends on the baud rate.

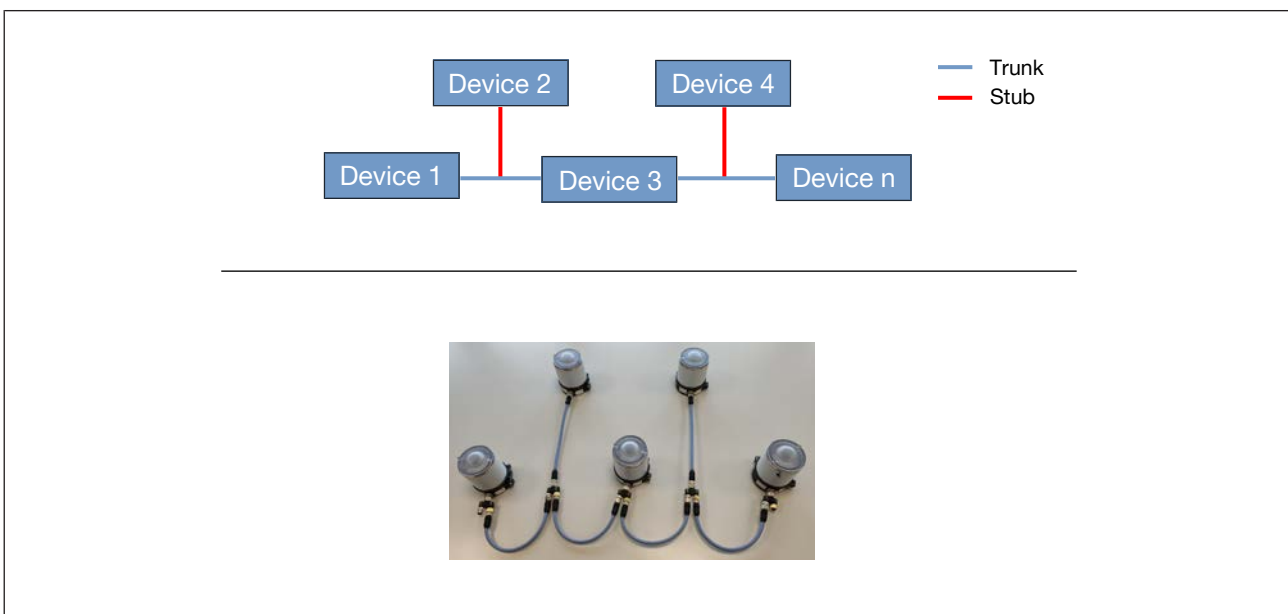

Fig. 10: Line topology with stub lines

5.3.3 Star topology

A star topology is used to interconnect devices when space is limited and a setup with a daisy chain topology is not possible.

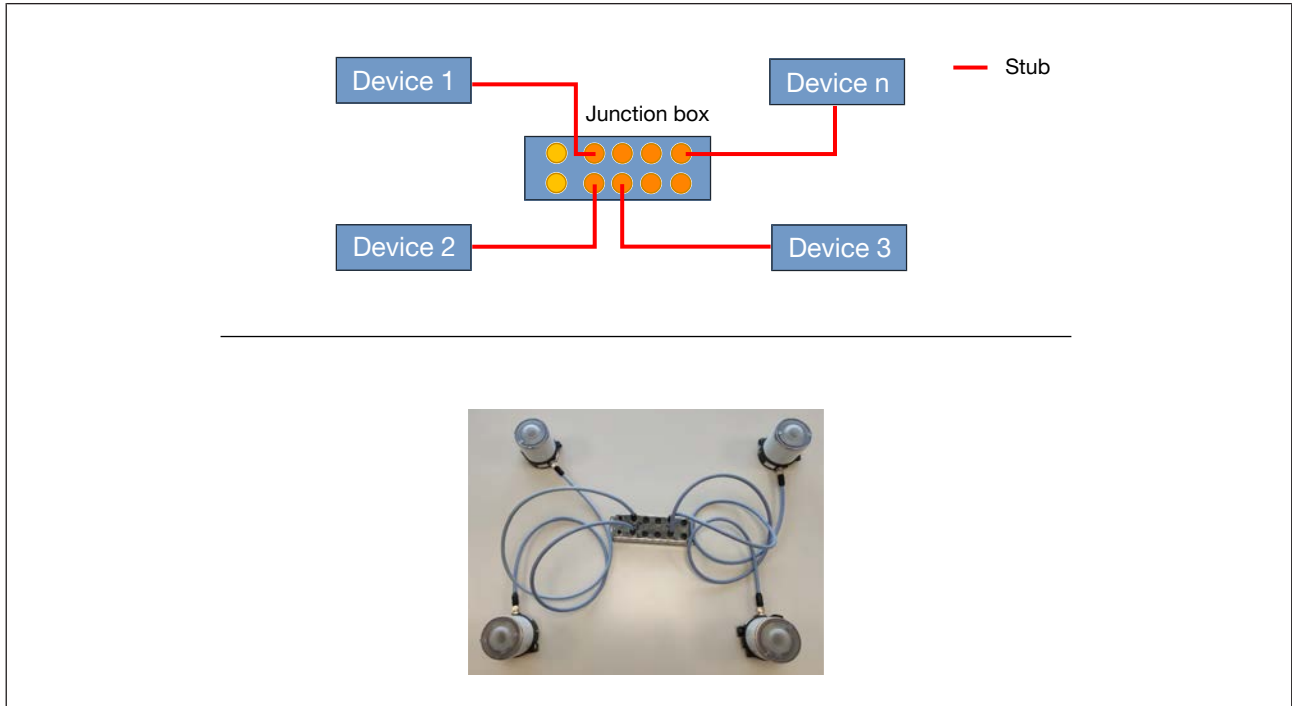

Fig. 11: Star topology

5.4 Which topologies are NOT recommended?

The topologies in this chapter are possible, but various criteria have to be observed to ensure the network works properly.

5.4.1 Tree topology

For signal quality, it is not recommended to use a tree topology. Cascading of the passive junction boxes is restricted to three. If more devices are needed, it is necessary to interconnect the trunk lines of the passive junction boxes and to not cascade more than three devices. Otherwise, the maximum stub line length is exceeded and errors may occur.

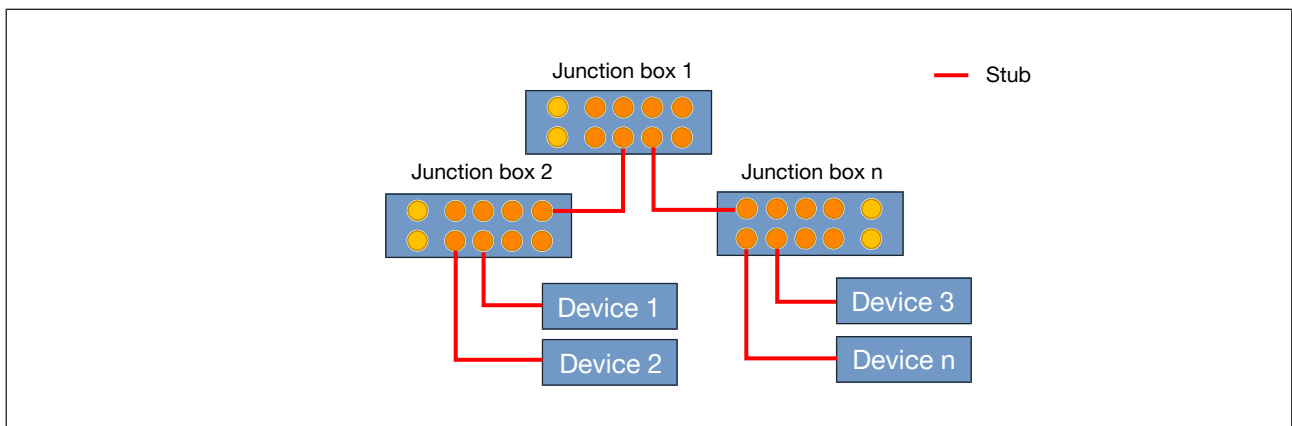

Fig. 12: Tree topology

5.5 Which topologies are NOT permitted

The topologies described in this section are not permitted. Never use them in a bÜS or CANopen network.

5.5.1 Ring topology

A ring topology is not permitted in a CANopen network. Choose another topology for the network.

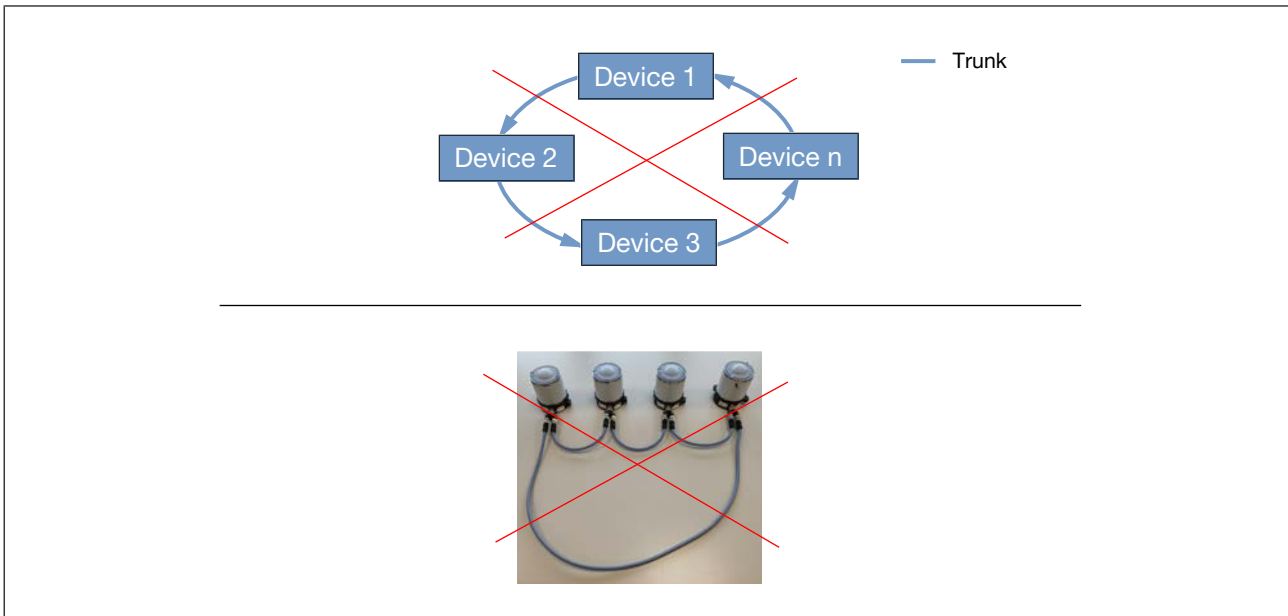

Fig. 13: Ring topology

6 DETAILED PROJECT PLAN 1

6.1 Floor plan

Create a detailed project plan using the aforesaid information about devices, cables lengths, topology, junction boxes and Y-connectors.

Are the devices close to each other?

YES: plan the network with a passive junction box

NO: plan the network with Y-connectors

Rules:

- Connect all the accessories on the trunk line
- Connect the accessories directly to the device
 - Use stub lines to connect the devices
 - Avoid long stub line lengths

6.1.1 Network with a junction box

In a network with one passive junction box, all the cables will be viewed as stub lines since there is no trunk line. Keep the stub lines as short as possible.

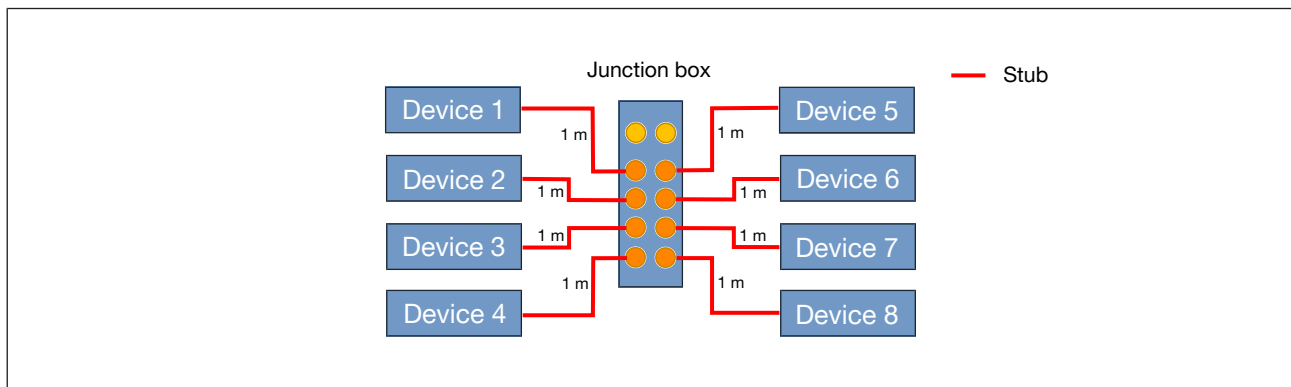

Fig. 14: Network with a junction box

6.1.2 Network with Y-connectors

A network with Y-connectors without stub lines (directly connected to the M12 connector of the device)

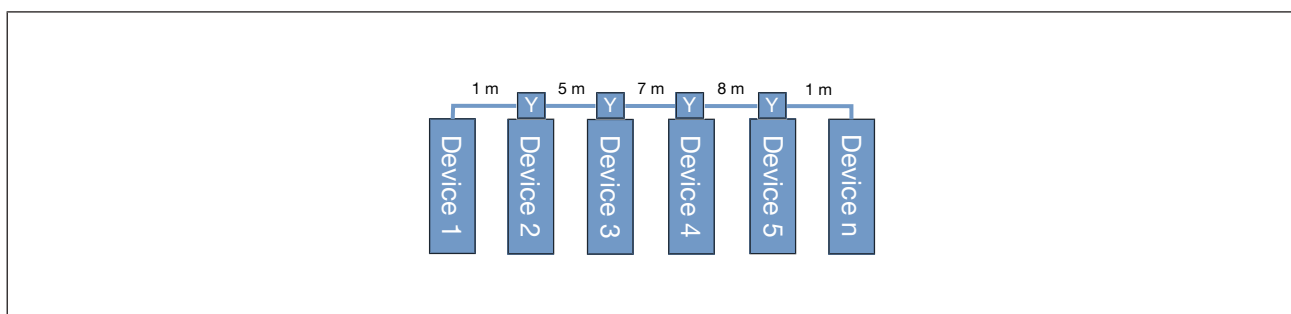

Fig. 15: Network with Y-connectors without stub lines

Network with Y-connectors and stub lines

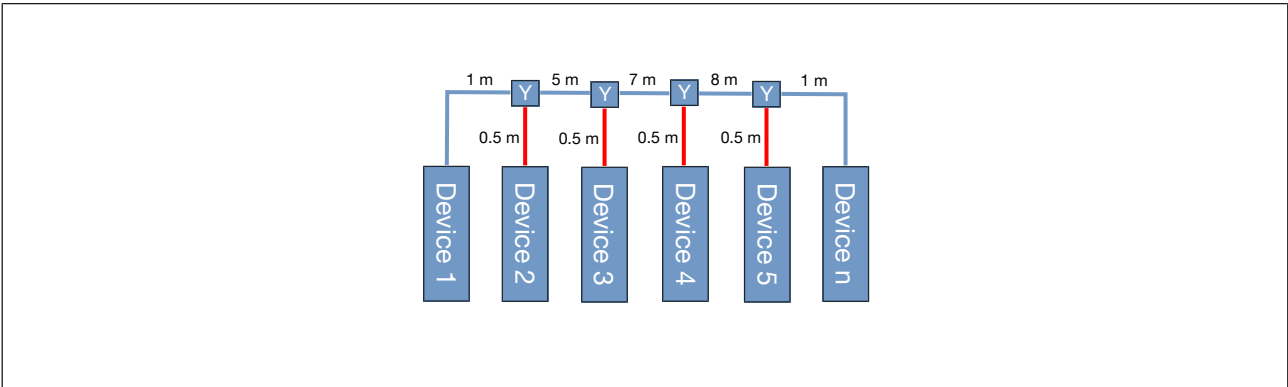

Fig. 16: Network with Y-connectors and stub lines

6.1.3 Mixed network

In a mixed network, it is important to indicate the total length of the cables. This includes the length of all trunk lines and stub lines.

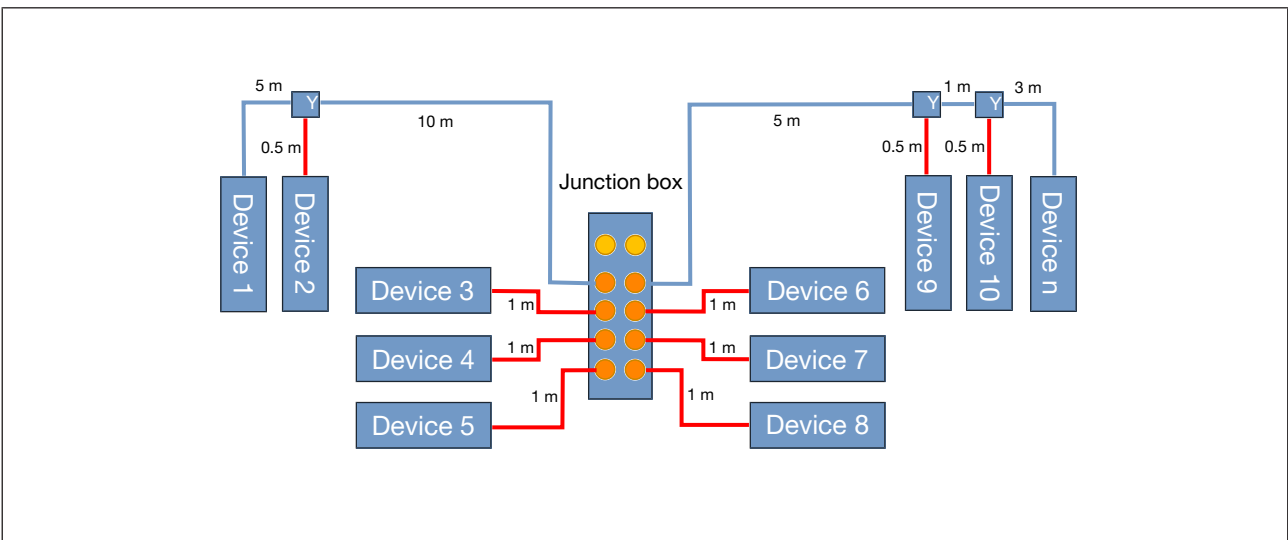

Fig. 17: Mixed network

7 TECHNICAL KNOW-HOW

7.1 Termination resistors

Termination resistors are located on each side of the trunk line. The impedance is approximately 60 Ω between CAN-HIGH and CAN-LOW.

Exception: In a large network with long stub lines, the longest distance between two devices should be estimated. It is also recommended to choose the longest distance in a network that consists of more than one passive junction box.

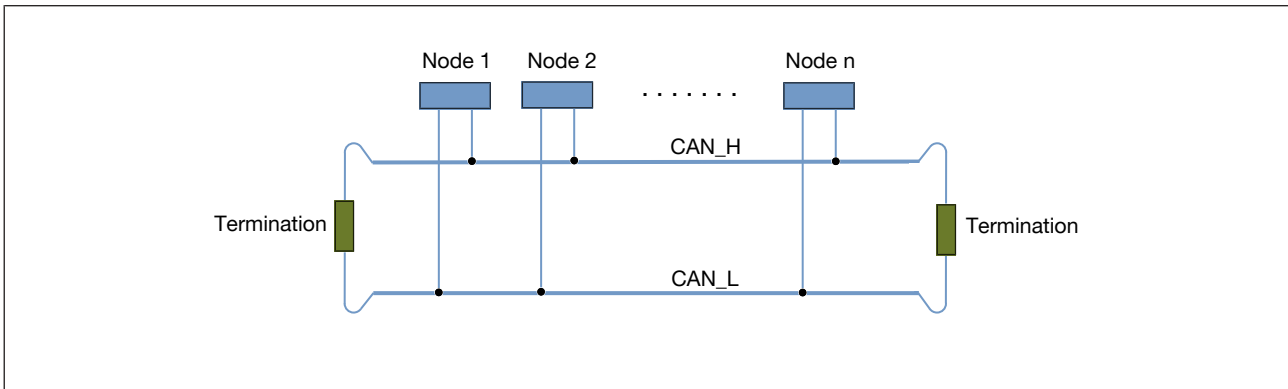

Fig. 18: Termination resistors

7.2 Connection for diagnostics

We recommend providing a free connection for diagnostics. A port of the junction box or an extra Y-connector in the network can be used. This access is important for fast diagnostics with büS stick and the Bürkert Communicator software.

Furthermore, it can be used for measurements with external tools, e.g. GEMAC CANBUS Tester 2. In this case, a measurement connection at both ends is recommended.

8 DETAILED PROJECT PLAN 2

8.1 Completion – floor plan

A cabling plan using the accessories, cables lengths, topology, junction box, Y-connector, termination resistor and a diagnostics port must be created.

8.1.1 Network with a junction box

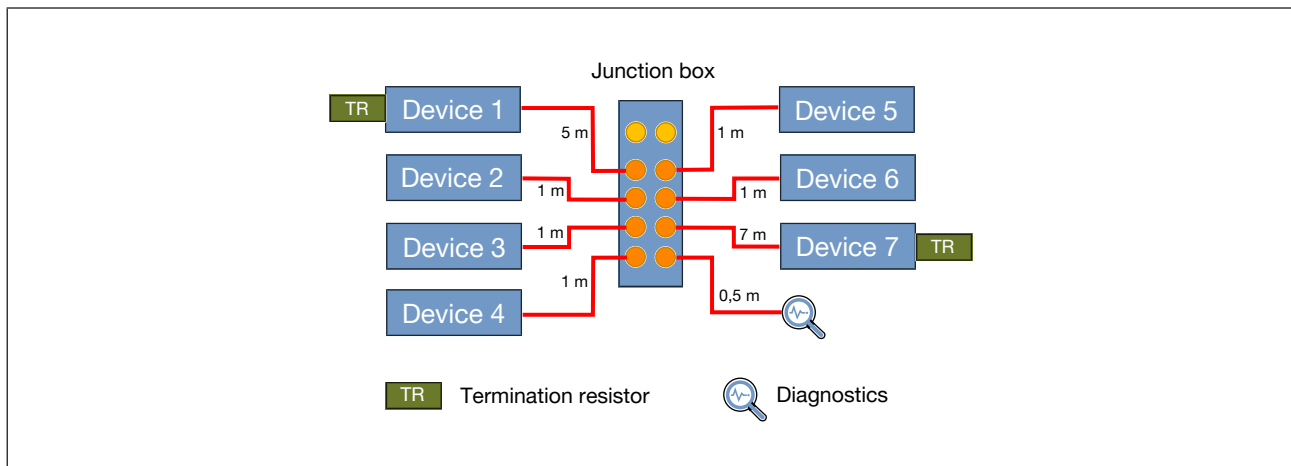

Fig. 19: Network with a junction box

In a network with a passive junction box, the termination resistors are connected to the devices with the longest distance to each other.

8.1.2 Network with Y-connectors

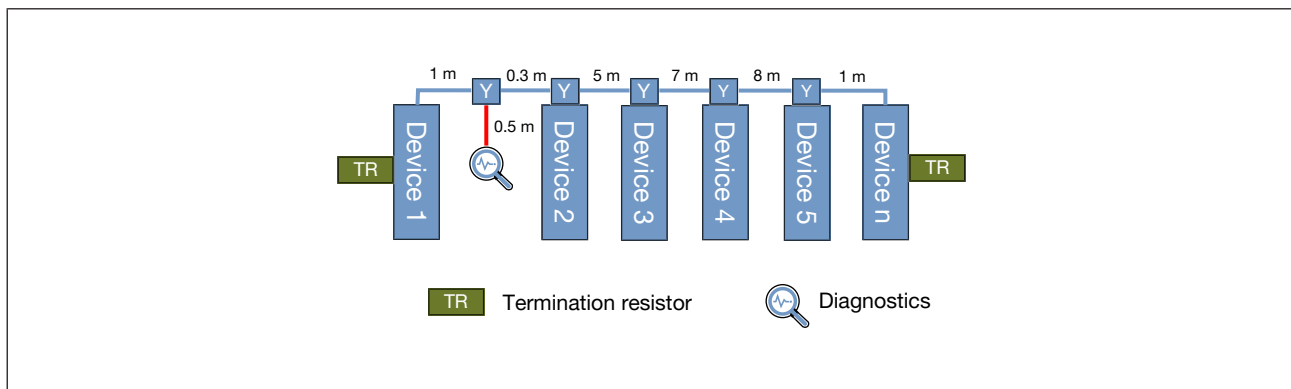

Fig. 20: Network with Y-connectors

Network without stub lines. The Y-connector is connected directly to the device.

8.1.3 Mixed network

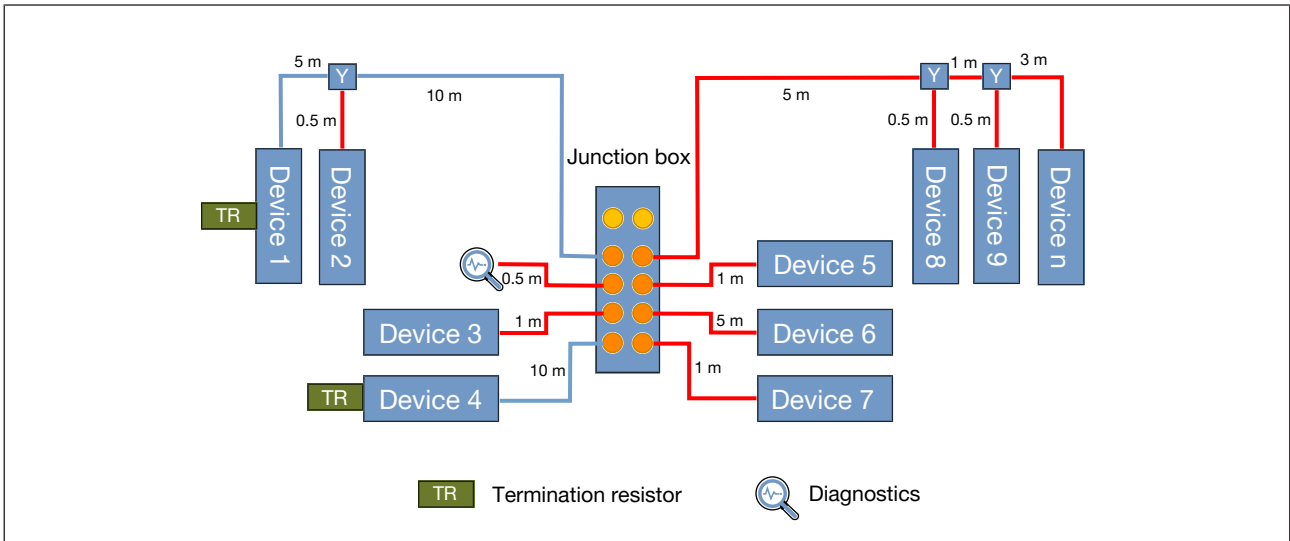

Fig. 21: Mixed network

For good signal quality, it is important to determine the longest distance between two devices in the entire network. Place the termination resistors close to these devices. This helps to reduce the signal reflections. Please do not exceed the maximum stub line length.

9 NETWORK POWER SUPPLY

9.1 Power segments

Calculate the overall power consumption of all the devices in the network. Build power segments with a maximum load of 100 W. This refers to the M12 connector (A-coded). This component has a current limit of approx. 4 A.

9.1.1 One power segment

In a network with one power supply, overall power consumption is limited to 100 W.

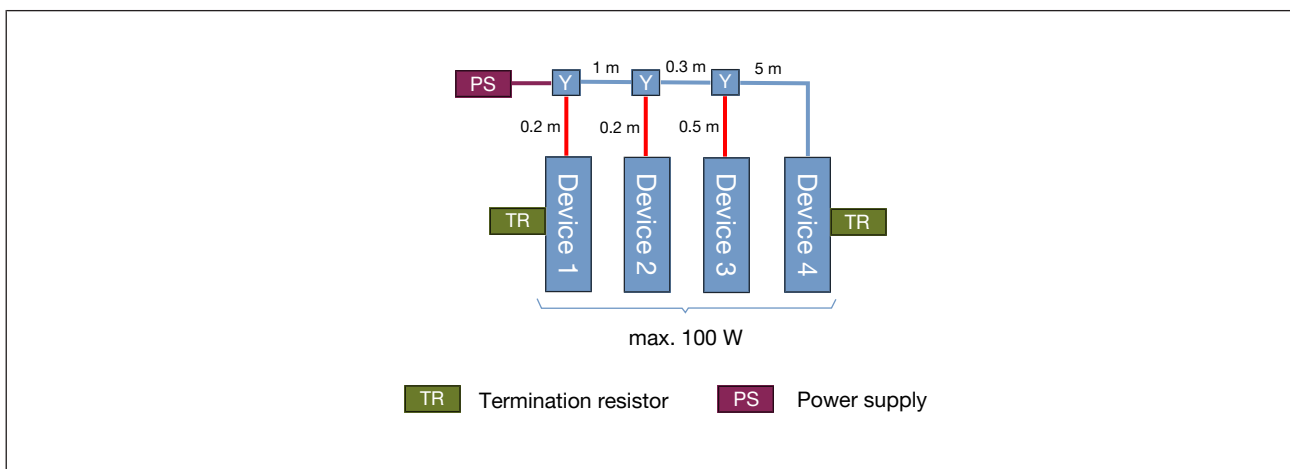

Fig. 22: One power segment

9.1.2 Additional power supply

For higher power consumption, use additional power supplies and Y-connectors with interrupt to utilise power from a second power supply.

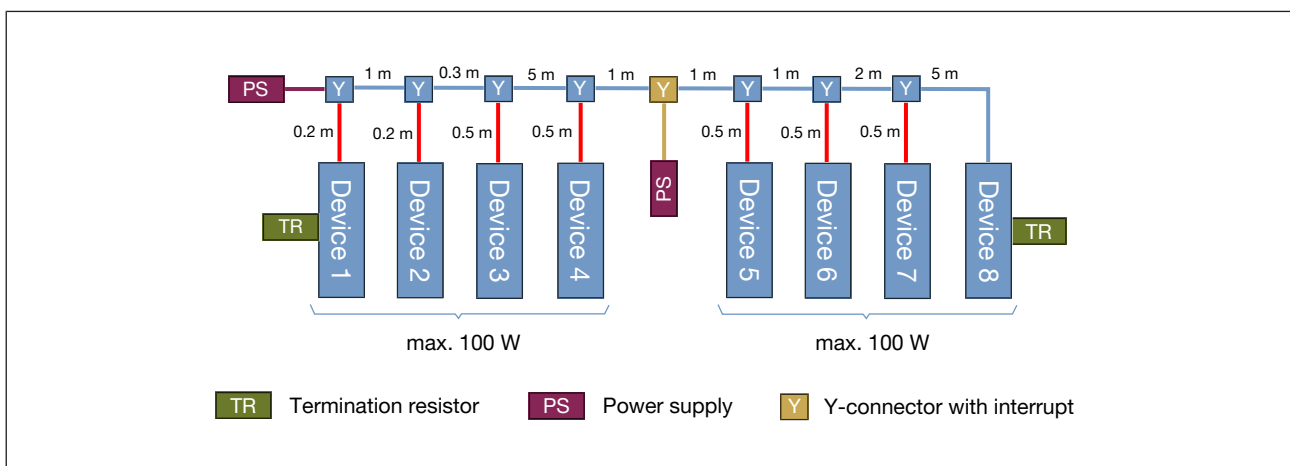

Fig. 23: Additional power supply

9.2 Rule of thumb

The rule of thumb is that 1 W load per metre results in a voltage drop of 1 mV. A maximum voltage drop of 5 V is allowed. Some devices will shut down if the supply voltage is lower than 19 V. Therefore, refer to the respective data sheet for more information.

10 DETAILED PROJECT PLAN 3

10.1 Cabling plan

Rough cabling plan, topology, rules of cabling (table).

Place your power supply (power < 100W) close to the load.

Y-connector, passive junction box, external power supply, galvanically isolated switched-mode power supplies (recognised UL Class 2).

10.1.1 Network with junction box

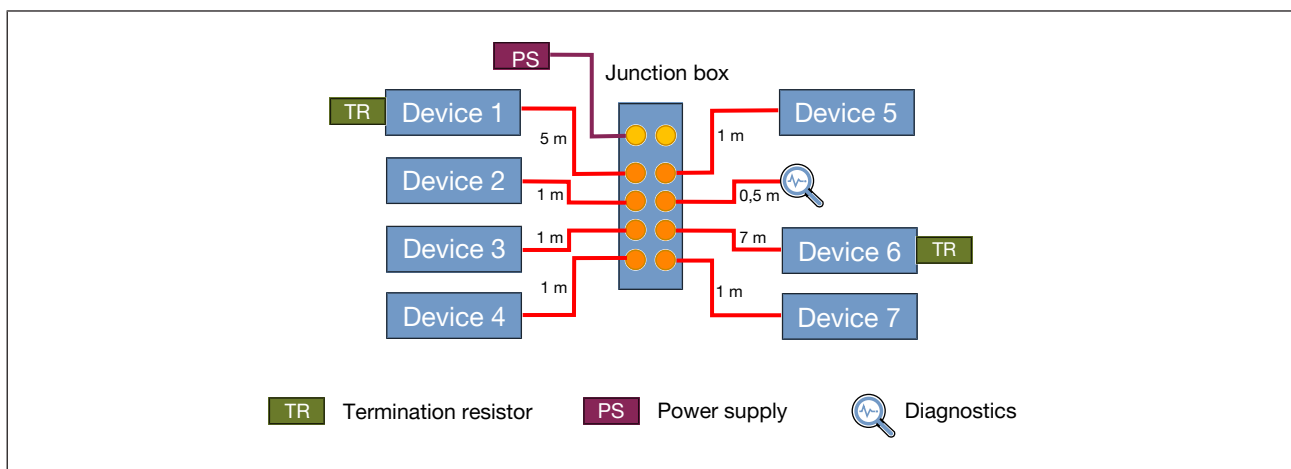

Fig. 24: Network with junction box

10.1.2 Network with Y-connectors

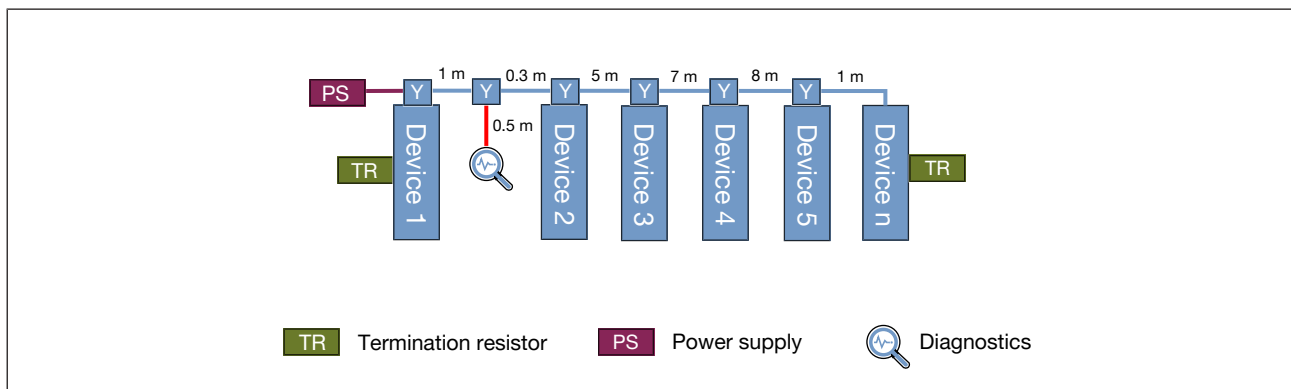

Fig. 25: Network with Y-connectors

10.1.3 Mixed network

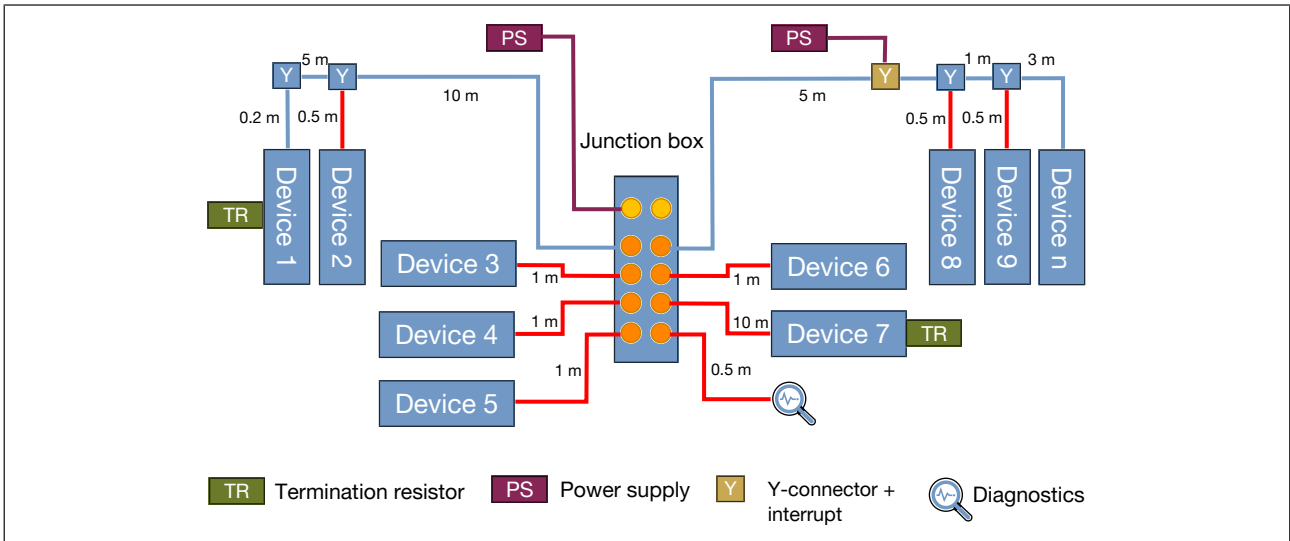

Fig. 26: Mixed network

11 BEST PRACTICE INSTRUCTIONS

11.1 Termination resistor

Termination resistors are located on each side of the trunk line. Each resistor has a resistance of approx. 120 Ω. Therefore, a network with a termination resistor at both ends has an impedance of 60 Ω. Resistors are available as a male or female M12 connector. Additionally, a chip resistor for ME43 and valve island Type 8652 is available.

11.2 Signal reflections

There might be more than one reason for signal reflections in a network. This depends on the number of devices, the baud rate, the amount of process data, the position of the termination resistors and the position of the measurement port.

Massive signal reflections occur if the position of the termination resistors is not selected correctly.

11.3 Passive junction box

Passive junction boxes are used for the distribution of devices that are close to each other. In a network with a passive junction box, it is important to determine the longest distance between two devices and to place the termination resistor there. In this case, it is not recommended to place these resistors on the trunk line.

11.4 Diagnostic port

In a bÜS network, one diagnostic port should be placed in one plant. It is used for fast access with the Bürkert Communicator or also a third-party tool, e.g. GEMAC CAN Bus Tester 2.

11.5 Baud rate

The default baud rate of all Bürkert devices is 500 kbit/s. In the case of a poor measurement result, it is possible to reduce the baud rate to 250 kbit/s or 125 kbit/s. Therefore, longer cables can be used in the network.

Please note that the total time of a firmware update increases when the baud rate is reduced to a lower communication speed.

11.6 bÜS stick

The bÜS stick is a USB-to-CAN converter and is connected to a laptop/PC with the Bürkert Communicator. It is used for the diagnostics, start-up and parameterisation of devices.

11.7 Stub lines

The total length of stub lines in the entire network should be reduced as much as possible. It is impossible to calculate exactly the impact that a one metre stub line has on reducing the signal quality in percentage terms.

11.8 Bus load

The maximum bus load is 40%. The specific bus load of a device is specified in the communication data sheet. To calculate the total bus load, sum up the values from the communication data sheet for all devices.

11.9 Power consumption

It is important to consider the power consumption of a device as early as possible in the planning. Using the information about the total power consumption of the network, the accessories and the number of power supplies can be planned.

Furthermore, the permitted voltage ripple of a device must be considered. For devices with direct access, e.g. MFCs, it is important to have a low residual ripple. For sensors, the impact is not that significant.

11.10 Grounding power supplies

Power supplies should not be earthed, but it is important to ensure galvanic isolation. Otherwise, huge loops may develop that can have a negative impact on the entire network.

12 BÜS NETWORKS WITH MAXIMUM NETWORK EXPANSION

Networks with varying devices, cable lengths, baud rates and topologies are tested.

The networks shown here should only serve as examples of what is possible and are intended as a reference point for your own setup. For large networks close to the limit or even above, it always makes sense to check the network quality.

12.1 Line topology

For the baud rates 500 kbit/s, 250 kbit/s and 125 kbit/s the maximum cable length and the maximum number of devices have been determined.

12.1.1 500 kbit/s

Communication of the entire büS network worked with up to 84 devices and 1 büS stick. The total cable length was 75 metres.

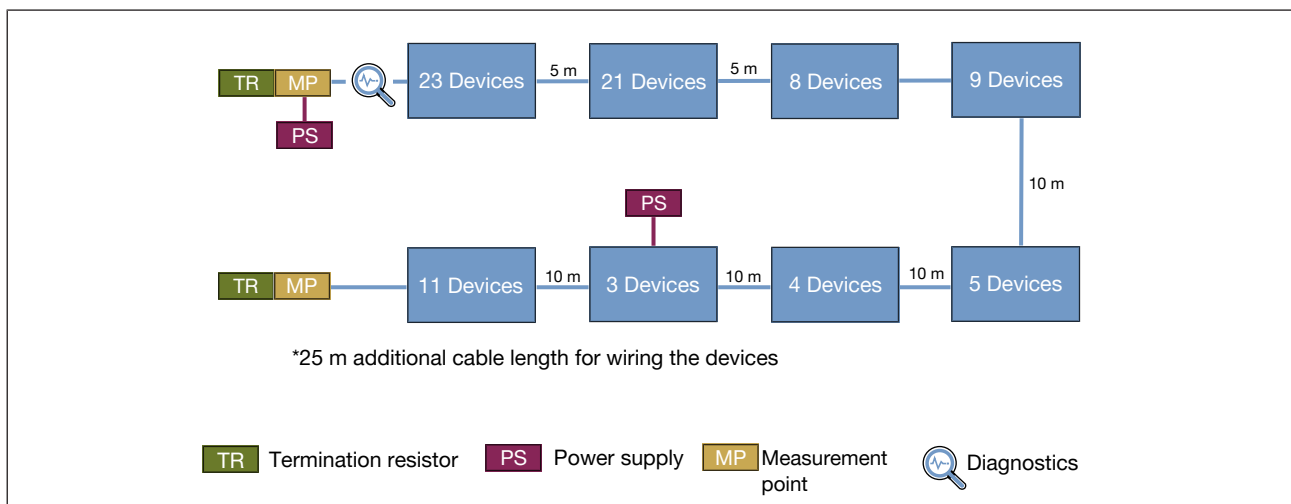

Fig. 27: 500 kbit/s, 84 devices, cable length 75 m

Measurements with a maximum cable length of 100 metres was possible with 44 devices and 1 büS stick. A length of 100 metres is defined as the limit in the CANopen specification.

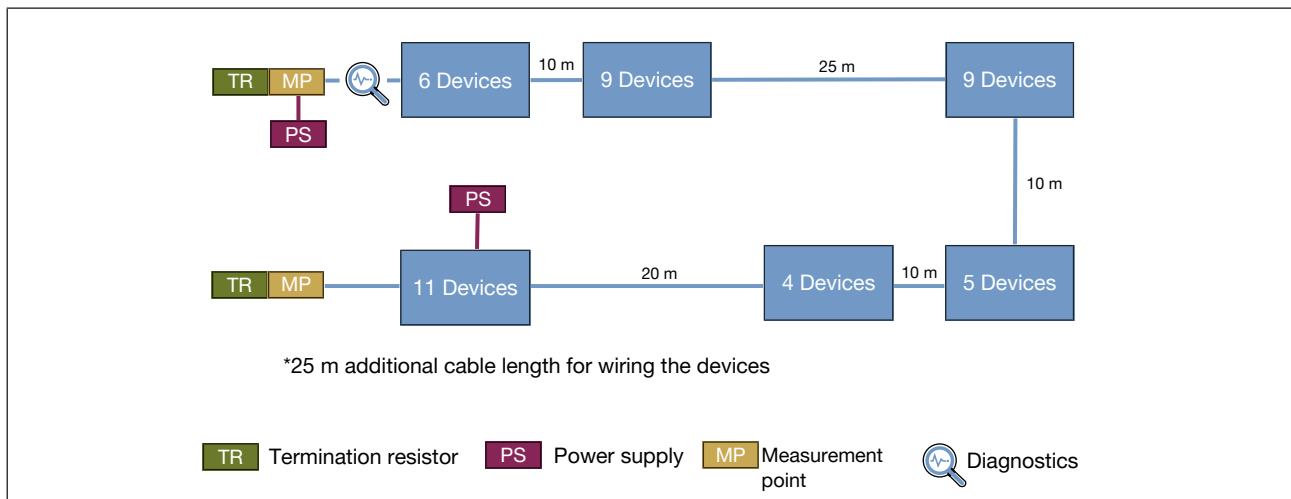

Fig. 28: 500 kbit/s, 44 devices, cable length 100 m

12.1.2 250 kbit/s

The network was tested with 84 devices and a total cable length of 175 metres and worked without any errors.

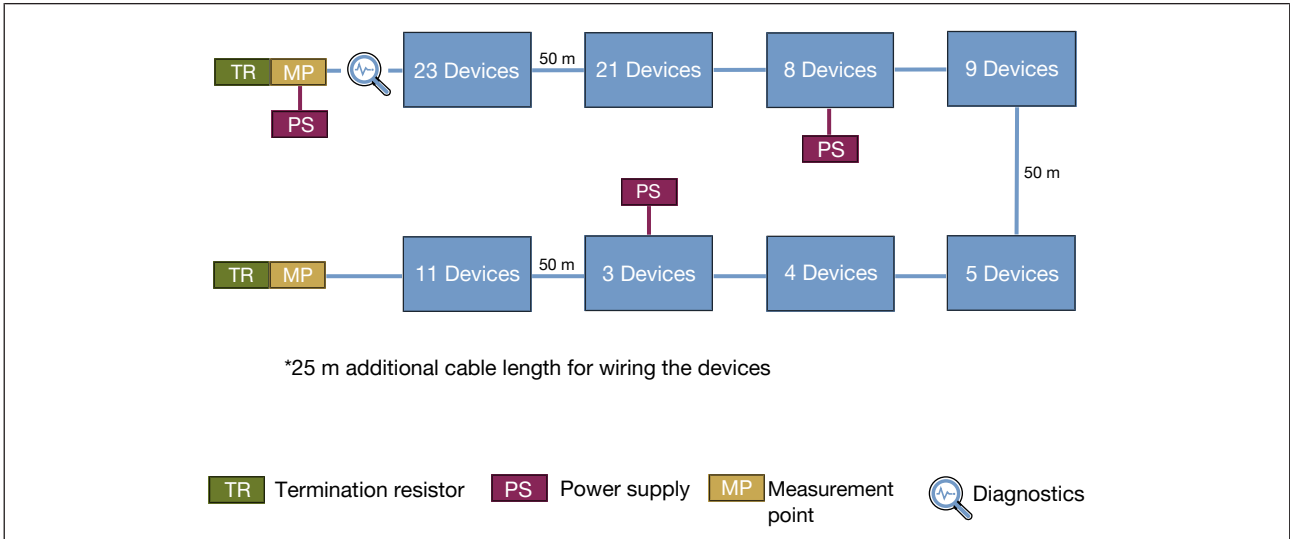

Fig. 29: 250 kbit/s, 84 devices, cable length 175 m

The system setup consists of 41 bÜS devices and 1 bÜS stick with a total cable length of 250 metres, which is defined as the maximum.

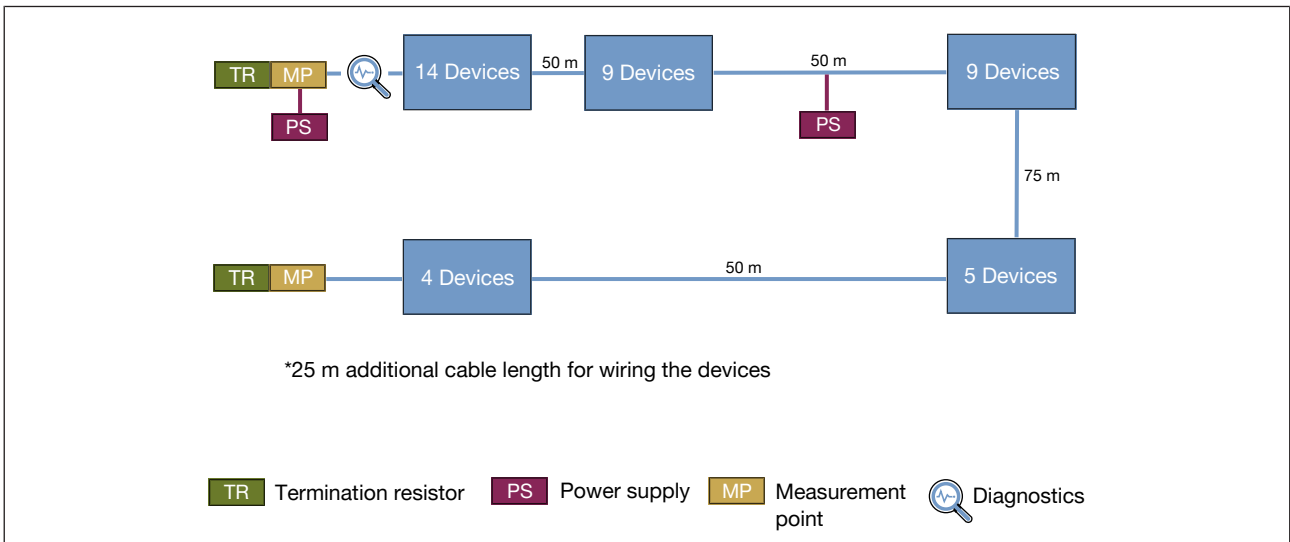

Fig. 30: 250 kbit/s, 41 devices, cable length 250 m

12.1.3 125 kbit/s

The network can have a total cable length of 475 metres with 84 devices and 1 büS stick.

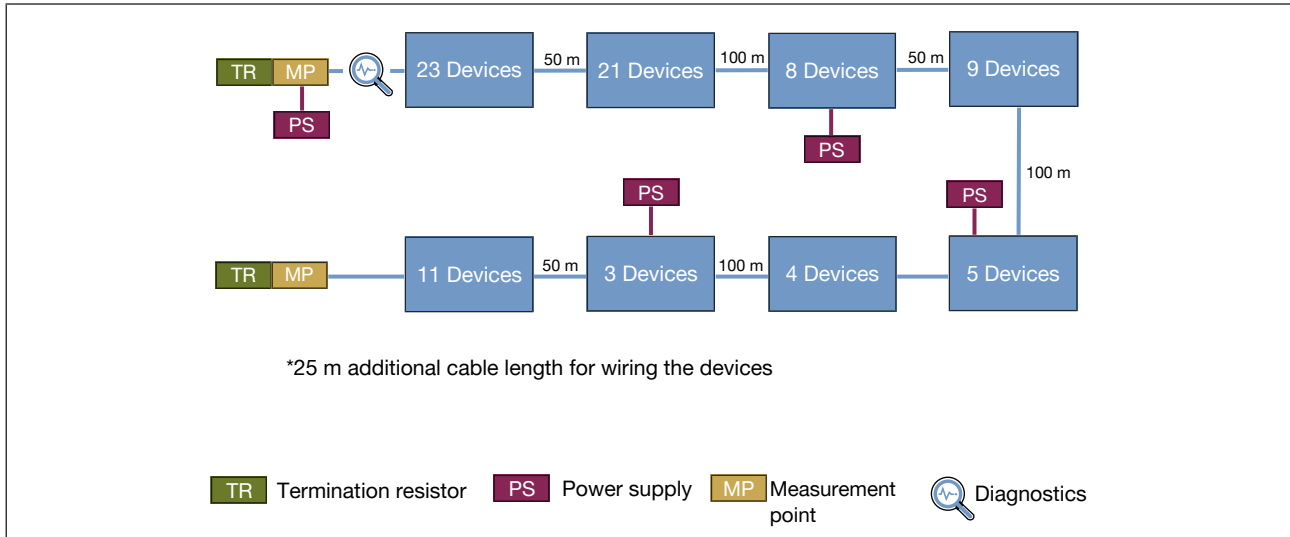

Fig. 31: 125 kbit/s, 84 devices, cable length 475 m

With 125 kbit/, it is possible to connect up to 53 devices with a total cable length of 500 metres.

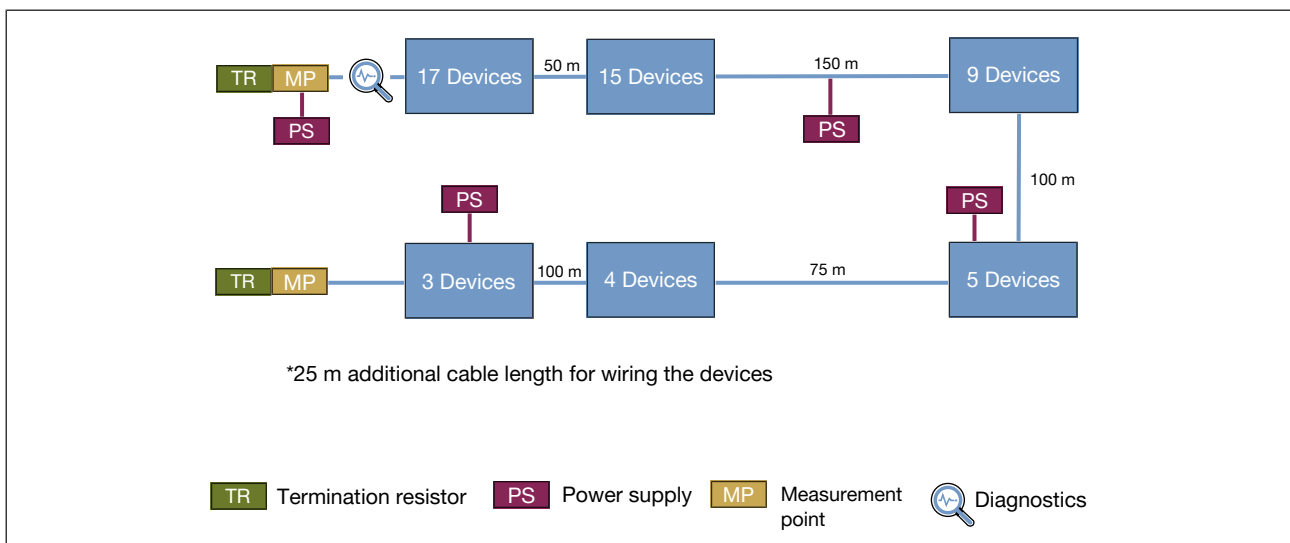

Fig. 32: 125 kbit/s, 53 devices, cable length 500 m

12.2 Star topology with a junction box

If a passive junction box is used, all the cables are stub lines. With a baud rate of 500 kbit/s, a total stub line length of 25 metres is permitted. The maximum length of each stub line is limited to 5 metres. If all the stub lines have the same length, the position of the termination resistor is irrelevant.

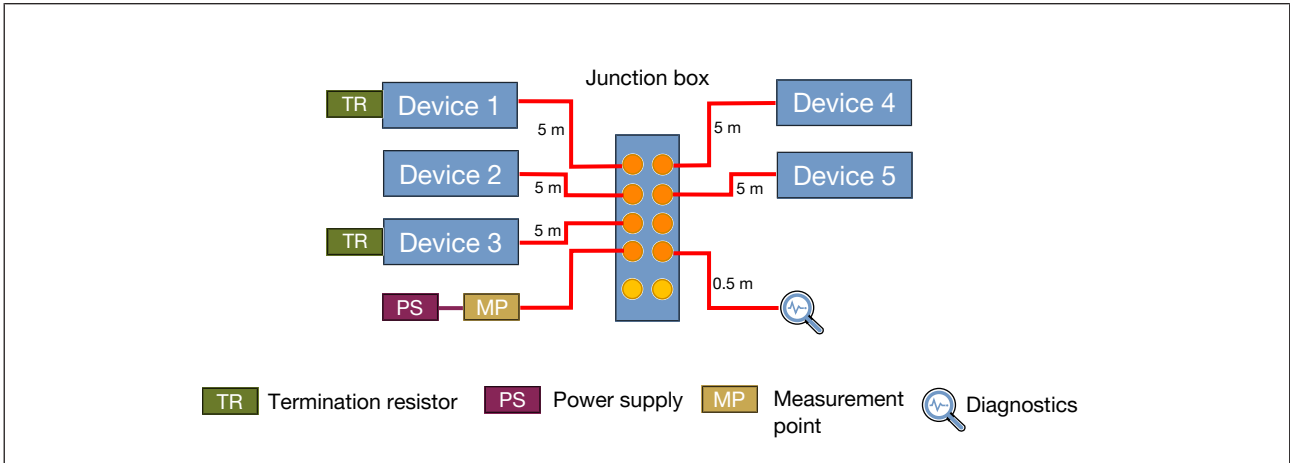

Fig. 33: Star topology with a junction box

12.3 Tree topology with a junction box

With a tree topology, a total cable length of 94 metres was measured with 23 devices in the network. The stub line length varies between 1 and 10 metres.

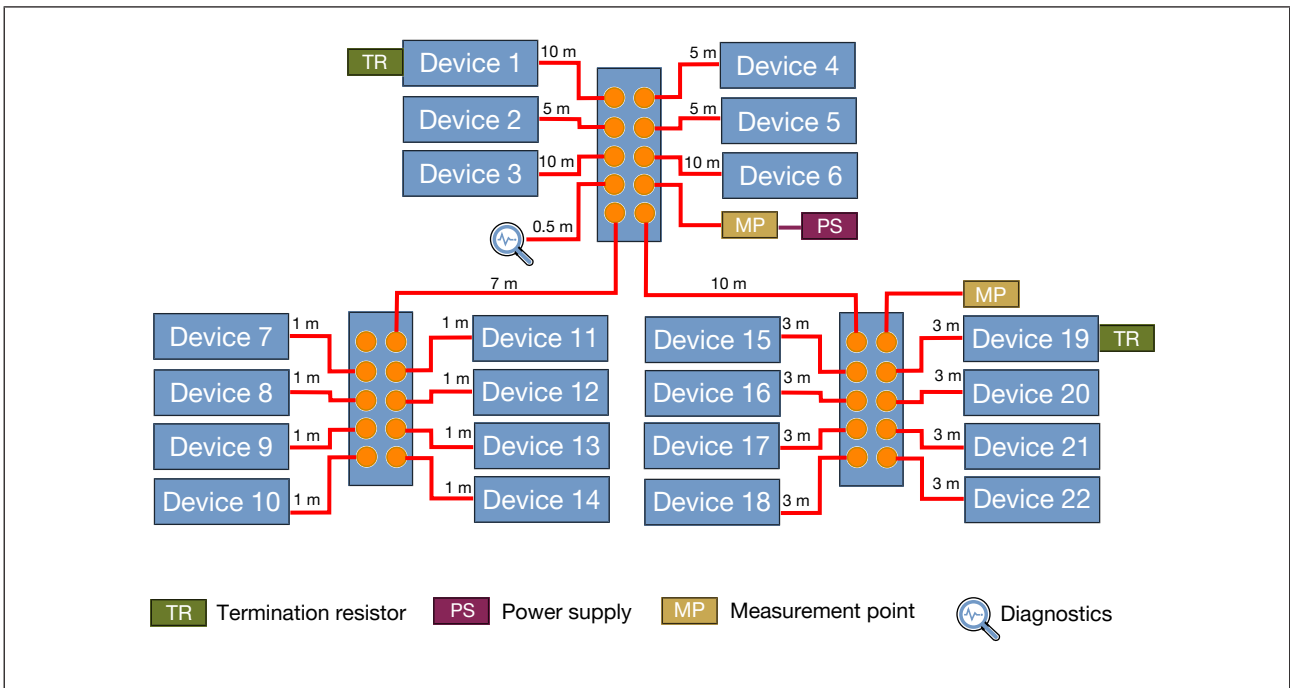

Fig. 34: Tree topology with a junction box

13 TROUBLESHOOTING

13.1 Sporadic disconnections

Description:

In a faulty network, it is possible to experience sporadic disconnections. Therefore, one or more devices may disappear for a few seconds. This is an indication that something has gone wrong.

Common problems:

- More or less than two termination resistors
- Total cable length is too long
- Total stub line length is too long
- Bus load is too high
- Undersized power supply

Solution:

- Measurement of the impedance between CAN-High and CAN-Low. The impedance should be approx. 60 Ω
- Reduce the cable length
- Reduce the baud rate to the next lower communication speed
- Create power segments in the network with more power supplies and Y-connectors

13.2 Red LED (failure)

Description:

The LED of a single device or the entire EDIP network lights up red.

Common problems:

- Incorrect connection to the PLC
- Device reached critical limit, e.g. power supply too low
- EDIP partner is missing

Solution:

- Check the cabling to the PLC and configure the PLC with the description files of the device
- Check the messages of the device with the PLC or Bürkert Communicator
- Check the partner name and mapping

13.3 Orange LED on the device (functional check)

Description:

The LED of a single device or the entire EDIP network lights up orange.

Common problems:

- Partner allocation is active
- PLC has “stopped”
- Simulation is active
- Manual mode

Solution:

- Wait until the device finds its partner in the network
- Set the PLC to “RUN”
- Deactivate simulation
- Set the device to “Automatic”

13.4 Yellow LED on the device (out of specification)

Description:

The LED of a single device or multiple devices in the network lights up yellow.

Common problems:

- Device has reached an internal limit, e.g. temperature
- Teach function is required
- Device cannot reach the setpoint

Solution:

- Check the limits and messages with the PLC or Bürkert Communicator
- Start the device teach function
- Check the medium pressure

13.5 Blue LED on the device (maintenance required)

Description:

The LED of a single device or multiple devices in the network lights up blue.

Common problems:

- Switching cycle counter limit has been reached
- Config-Provider/Client missing
- Damaged calibration curve

Solution:

- Reset the switching cycle counter
- Replace the missing device
- Recalibrate the device

13.6 Restarting some devices

If the LED first lights up yellow and then turns red or green, it is an indication that the power supply has reached a limit for stable operation. If one device switches an actor on, the voltage drop is so high that the power falls below the limit and a restart will be performed.

14 APPENDIX

14.1 Accessories - bÜS stick interface sets

Accessories - bÜS stick interface sets	Bürkert order no.
USB-bÜS interface set 1	00772426
USB-bÜS interface set 2	00772551

Tab. 6: bÜS stick

14.2 Accessories - connectors

Accessories - connectors	Bürkert order no.
bÜS connector, female, M12	00772416
bÜS connector, male, M12	00772417
bÜS connector, female angled, M12	00772418
bÜS connector, male angled, M12	00772419
bÜS Y-connector, M12	00772420
bÜS Y-connector, M12 with interrupt	00772421
bÜS gender changer	00772867
bÜS termination, male, M12	00772424
bÜS termination, female, M12	00772425
Terminal block 4 pin with termination	00566066
Termination chip resistor ME43	00303833

Tab. 7: Connectors

14.3 Accessories - cables (open leads)

Accessories - cables (open leads)	Bürkert order no.
bÜS connecting cable 0.7 m	00772626
bÜS connecting cable 1 m	00772409
bÜS connecting cable 3 m	00772410
bÜS connecting cable 5 m	00772411
bÜS connecting cable 10 m	00772412
bÜS connecting cable 50 m (cable drum)	00772413
bÜS connecting cable 100 m (cable drum)	00772414
bÜS service cable, micro-USB-to-M12	00773254

Tab. 8: Cables (open leads)

14.4 Accessories - extension cables

Accessories - extension cables	Bürkert order no.
büS extension cable 0.1 m	00772492
büS extension cable 0.2 m	00772402
büS extension cable 0.5 m	00772403
büS extension cable 1 m	00772404
büS extension cable 3 m	00772405
büS extension cable 5 m	00772406
büS extension cable 10 m	00772407
büS extension cable 20 m	00772408

Tab. 9: Extension cables

14.5 Accessories - power supplies

Accessories - power supplies	Bürkert order no.
Power supply, 1A, NEC Class 2	00772361
Power supply, 2A, NEC Class 2	00772362
Power supply, 3.8A, NEC Class 2	00772898
Power supply, 10A	00772698

Tab. 10: Power supplies

14.6 Accessories - power cables

Accessories - power cables (L-coded M12 plug to M12 socket, 4-pin)	Bürkert order no.
Power cable, L-coded, 1 m	00775061
Power cable, L-coded, 3 m	00772403
Power cable, L-coded, 5 m	00772404
Power cable, L-coded, 10 m	00772405

Tab. 11: Power cables



Further accessories available on the Bürkert homepage.