



Inline sensor-fitting with integrated paddle wheel for measuring flow rate

- DN 06...DN 65
- Many different materials and process connections are available in order to optimally adapt to individual applications and process conditions.
- Closed pipeline system, i.e. the sensor is a component of the fitting
- Quarter-turn technology (Bürkert bayonet catch)
- Transmitters can be supplied for display, monitoring, signal transmission, 2-point control and dosing control

Product variants described in the data sheet may differ from the product presentation and description.

Can be combined with

	Type SE30 Transmitter for Inline sensor-fitting	▶
	Type SE32 Transmitter for Inline sensor-fitting	▶
	Type SE35 Transmitter or batch controller for Inline sensor-fitting	▶
	Type SE36 ELEMENT transmitter for Inline sensor-fitting	▶
	Type 8611 eCONTROL - Universal controller	▶

Type description

The Type S030 sensor-fitting has an integrated paddle wheel for measuring flow rate, and is specifically designed for use with neutral, mildly aggressive, particle-free liquids

The compact sensor-fitting (Type S030) must be equipped with a Bürkert transmitter (Type SE30, Type SE30 Ex, Type SE32, Type SE35, Type SE36, or Type 8611), which can be quickly and easily connected using a bayonet catch. Bürkert's "Inline Quarter-Turn" technology guarantees leak-free operation.

The rotation of the paddle wheel (with permanent magnets in the paddles) is detected without contact by the sensitive transmitter element through the sensor-fitting wall. The transmitter can be installed and removed without having to open up the pipeline or interrupt the operating process.

DTS 1000011766 EN Version: AO Status: RL (released | freigegeben | valide) printed: 03.02.2026

Table of contents

1. General technical data	4
2. Approvals and conformities	6
2.1. General notes	6
2.2. Conformity	6
2.3. Standards	6
2.4. Pressure Equipment Directive (PED)	6
Device used in a pipe	6
2.5. Foods and beverages/Hygiene	6
3. Materials	7
3.1. Bürkert resistApp	7
3.2. Material specifications	7
4. Dimensions	8
4.1. Metal sensor-fitting	8
Internal thread connection	8
External thread connection	8
Weld spigot connection	9
Clamp connection	10
Flange connection	11
4.2. Plastic sensor-fitting	11
True union connection with nut and solvent/fusion socket	11
External thread connection	12
Solvent/fusion spigot connection	12
5. Performance specifications	13
5.1. Pressure temperature diagram	13
With Inline sensor-fitting Type S030 standard	13
With Inline sensor-fitting Type S030 -HT	13
6. Product installation	14
6.1. Installation notes	14
Flow measurement	14
6.2. Selection of the nominal diameter	15
7. Product operation	15
7.1. Measurement principle	15
8. Product design and assembly	16
8.1. Product assembly	16
9. Product accessories	16
10. Networking and combination with other Bürkert products	17
11. Ordering information	18
11.1. Bürkert eShop	18
11.2. Recommendation regarding product selection	18
11.3. Bürkert product filter	18
11.4. Ordering chart	19
Metal sensor-fitting	19

	Plastic sensor-fitting	20
	Stainless steel sensor-fitting (S030-HT variant)	21
11.5.	Ordering chart accessories.....	21a

1. General technical data

Note:

In the range of sensor-fittings, there are specific ones for the measurement of flow rates at high temperature and pressure. These are the Type S030-HT models, which can only be used with the Type SE30 transmitter in the high temperature variant (Type SE30-HT).

Product properties

Material

Make sure the device materials are compatible with the fluid you are using.
Further information can be found in chapter [“3.1. Bürkert resistApp” on page 7.](#)

Further information on the materials can be found in chapter [“3.2. Material specifications” on page 7.](#)

Non-wetted parts

Screw Stainless steel (316L - 1.4404)

Wetted parts

Sensor armature Stainless steel (316L - 1.4404), brass (CuZn₃₉Pb₂), PVC, PP or PVDF (depending on the sensor-fitting variant Type S030)

Axis Ceramics (Al₂O₃)

Bearing

- Ceramics (Al₂O₃)
- Iglidur® (only for Type S030-HT variant)

Paddle wheel

- PVDF
- Stainless steel (316L - 1.4404) (only for Type S030-HT variant)
- PP on request

Sensor-fitting body Stainless steel (316L - 1.4404), brass (CuZn₃₉Pb₂), PVC, PP or PVDF (depending on the sensor-fitting variant Type S030)

Seal FKM or EPDM (depending on the sensor-fitting variant Type S030)
Further information can be found in chapter [“11.5. Ordering chart accessories” on page 21.](#)

Surface quality For sensor-fitting in stainless steel:

- inner surface: Ra < 1.6 µm
- outer surface: Ra < 3.2 µm

Compatibility

- Bürkert flow transmitter Type SE30, Type SE30 Ex, Type SE32, Type SE35, Type SE36, batch controller Type SE35 or Universal controller Type 8611
- Bürkert flow transmitter Type SE30-HT (only for Type S030-HT variant)

Pipe diameter DN 06...DN 65

Dimensions Further information can be found in chapter [“4. Dimensions” on page 8.](#)

Measurement principle Paddle wheel

Measuring range Flow rate: 0.5...1200 l/min (0.13...317 gpm)

Performance data

Measurement deviation

- Teach-in (via a remote transmitter): ± 1% of the measured value¹⁾ at teach-in flow rate value
- Standard K factor: ± 2.5% of the measured value¹⁾

Linearity ± 0.5% of full scale¹⁾

Repeatability ± 0.4% of the measured value¹⁾

Medium data

Fluid Clean, neutral or slightly aggressive, solid-free liquids

Fluid temperature For sensor-fitting in:

- PVC: 0...+ 50 °C (+ 32...+ 122 °F)
- PP: 0...+ 80 °C (+ 32...+ 176 °F)
- PVDF, stainless steel or brass: - 15...+ 100 °C (+ 5...+ 212 °F)
- stainless steel (Type S030-HT variant): - 15...+ 125 °C (+ 5...+ 257 °F)

Fluid pressure For sensor-fitting in:

- plastic: max. PN 10
- metal: max. PN 16
- stainless steel (Type S030-HT variant):
 - max. PN 40 (for - 15...+ 90 °C (+ 5...+ 194 °F) temperature range)
 - max. PN 25 (for + 90...+ 125 °C (+ 194...+ 257 °F) temperature range)

 Further information can be found in chapter [“5.1. Pressure temperature diagram” on page 13.](#)

Viscosity Max. 300 cSt.

Rate of solid particles Max. 1%

Maximum particle size	0.5 mm
Flow velocity	<ul style="list-style-type: none"> • 0.3...10 m/s • 0.5...10 m/s (only for Type S030-HT variant) Further information can be found in chapter "6.2. Selection of the nominal diameter" on page 15.

Product connections

Measuring devices connection	Bürkert bayonet catch
Pipe connection	For sensor-fitting in: <ul style="list-style-type: none"> • plastic: true union with nut and solvent/fusion socket, spigot or external thread • metal: internal or external thread, weld ends, clamp or flange • stainless (Type S030-HT variant): internal or external thread, weld ends (clamp or flange on request)

Approvals and conformities

Directives

CE directive	Further information on the CE directive can be found in chapter "2.3. Standards" on page 6.
Pressure equipment directive	Complying with article 4, paragraph 1 of 2014/68/EU directive Further information on the pressure equipment directive can be found in chapter "2.4. Pressure Equipment Directive (PED)" on page 6.
Foods and beverages/Hygiene	FDA declaration of conformity (only PVDF or stainless steel fitting, with PVDF paddle wheel and FKM or EPDM seal) Must be ordered separately. Further information can be found in chapter "11.5. Ordering chart accessories" on page 21.
Materials	<ul style="list-style-type: none"> • Inspection certificate 3.1 (according to EN-ISO 10204) • Certification of conformity for the surface finish (according to DIN4762, DIN4768, ISO/4287/1) Must be ordered separately. Further information can be found in chapter "11.5. Ordering chart accessories" on page 21.
Others	<ul style="list-style-type: none"> • 3 points flow calibration certificate • Test report 2.2 (according to EN-ISO 10204) Must be ordered separately. Further information can be found in chapter "11.5. Ordering chart accessories" on page 21.

Environment and installation

Ambient temperature	Operation and storage: for sensor-fitting in <ul style="list-style-type: none"> • PVC: - 15...+ 60 °C (+ 5...+ 122 °F) • PP: - 15...+ 80 °C (+ 5...+ 176 °F) • PVDF, stainless steel or brass: - 15...+ 100 °C (+ 5...+ 212 °F) The temperature limits also depend on the used transmitter, see the relevant data sheet or operating instructions for more information.
---------------------	--

1.) Under reference conditions i.e. measurement medium = water, ambient and water temperature = + 20 °C (+ 68 °F), observing the minimum inlet and outlet sections and the appropriate inner diameter of the pipe.

2. Approvals and conformities

2.1. General notes

- The approvals and conformities listed below must be stated when making enquiries. This is the only way to ensure that the product complies with all required specifications.
- Not all available variants of the device can be supplied with the below mentioned approvals or conformities.

2.2. Conformity

In accordance with the Declaration of Conformity, the product is compliant with the EU Directives.

2.3. Standards

The applied standards which are used to demonstrate compliance with the EU Directives are listed in the EU-Type Examination Certificate and/or the EU Declaration of Conformity.

2.4. Pressure Equipment Directive (PED)

The device conforms to article 4, paragraph 1 of the Pressure Equipment Directive (PED) 2014/68/EU under the following conditions:

Device used in a pipe

Note:

- The data in the table is independent of the chemical compatibility of the material and the fluid.
- PS = maximum admissible pressure (in bar), DN = nominal diameter of the pipe

Type of fluid	Conditions
Fluid group 1, article 4, paragraph 1.c.i	DN ≤ 25
Fluid group 2, article 4, paragraph 1.c.i	DN ≤ 32 or PS*DN ≤ 1000
Fluid group 1, article 4, paragraph 1.c.ii	DN ≤ 25 or PS*DN ≤ 2000
Fluid group 2, article 4, paragraph 1.c.ii	DN ≤ 200 or PS ≤ 10 or PS*DN ≤ 5000

2.5. Foods and beverages/Hygiene

Note:

The specific sensor-fittings (S030-HT) for the measurement of flow rates at high temperature and pressure is not covered by this certificat.

Conformity	Description
FDA	FDA – Code of Federal Regulations The variants with the sensor-fitting body and the sensor armature made of PVDF or stainless steel materials, the paddle wheel made of PVDF material and the seal made of FKM or EPDM materials are compliant in their composition with the Code of Federal Regulations published by the FDA (Food and Drug Administration, USA) according to the manufacturer's declaration.

3. Materials

3.1. Bürkert resistApp

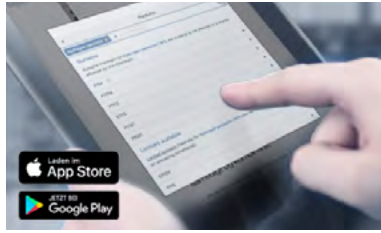

Bürkert resistApp – Chemical resistance chart

You want to ensure the reliability and durability of the materials in your individual application case? Verify your combination of media and materials on our website or in our resistApp.

[Start chemical resistance check](#)

3.2. Material specifications

Note:

The following picture describes the sensor-fitting with a process true union connection with nut and solvent/fusion socket, but this also applies to all variants of process connection.

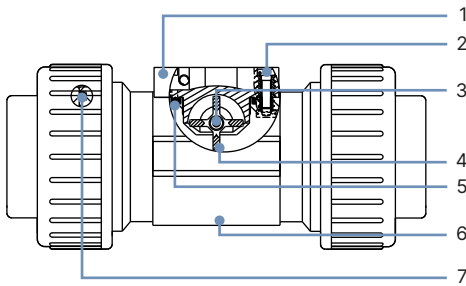

No.	Element	Material
1	Sensor armature	Stainless steel
2	Screws	Stainless steel
3	Axis and bearings	<ul style="list-style-type: none"> • Axis in ceramics (Al_2O_3) • Bearings in: <ul style="list-style-type: none"> – ceramics (Al_2O_3) – Iglidur® (only for Type S030-HT variant)
4	Paddle wheel	<ul style="list-style-type: none"> • PVDF • Stainless steel (only for Type S030-HT variant)
5	Seal	FKM or EPDM (depending on Type S030 variant)
6	Sensor-fitting body	<ul style="list-style-type: none"> • Stainless steel (316L - 1.4404), brass ($CuZn_{39}Pb_2$), PVC, PP, PVDF (depending on the sensor-fitting variant Type S030) • Stainless steel (316L - 1.4404) (only for Type S030-HT)
7	Seals	FKM or EPDM (depending on the sensor-fitting variant Type S030 and only for true union connection with nut and solvent/fusion socket)

DTS 1000011766 EN Version: AO Status: RL (released | freigegeben | valide) printed: 03.02.2026

4. Dimensions

4.1. Metal sensor-fitting

Internal thread connection

Note:

Dimensions in mm, unless otherwise stated

G, NPT or Rc in stainless steel (316L - 1.4404) or brass (CuZn₃₉Pb₂)

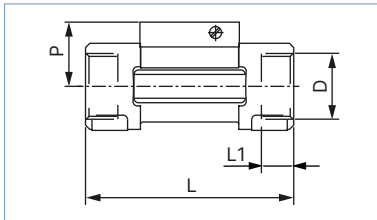

DN	P	L	L1	D
				[inch]
15	34.5	84.0	16.0	G 1/2
				NPT 1/2
				Rc 1/2
20	32.0	94.0	17.0	G 3/4
				NPT 3/4
				Rc 3/4
25	32.2	104.0	23.5	G 1
				NPT 1
				Rc 1
32	35.8	119.0	23.5	G 1 1/4
				NPT 1 1/4
				Rc 1 1/4
40	39.6	129.0	23.5	G 1 1/2
				NPT 1 1/2
				Rc 1 1/2
50	45.7	148.5	27.5	G 2
				NPT 2
				Rc 2

External thread connection

Note:

Dimensions in mm, unless otherwise stated

G, NPT or Rc in stainless steel (316L - 1.4404) or brass (CuZn₃₉Pb₂)

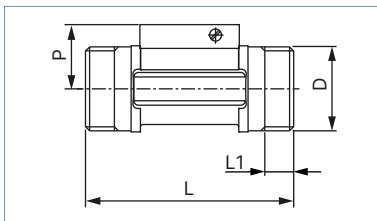

DN	P	L	L1	D
				[inch]
06	29.5	90.0	14.0	G 1/2
08	29.5	90.0	14.0	G, NPT or Rc 1/2
15	34.5	84.0	11.5	G 3/4
20	32.0	94.0	13.5	G 1
25	32.2	104.0	14.0	G 1 1/4
32	35.8	119.0	18.0	G 1 1/2

SMS 1145 in stainless steel (316L - 1.4404)

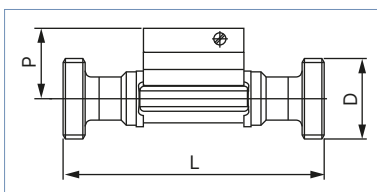

DN	P	L	D
25	32.0	130	Rd 40 x 1/6"
40	35.8	164	Rd 60 x 1/6"
50	39.6	173	Rd 70 x 1/6"

Weld spigot connection

Note:

Dimensions in mm, unless otherwise stated

EN ISO 1127/ISO 4200/DIN 11866 series B, SMS 3008, BS 4825-1/ASME BPE/DIN 11866 series C or DIN 11850 series 2/DIN 11866 series A/ DIN EN 10357 series A in stainless steel (316L - 1.4404)

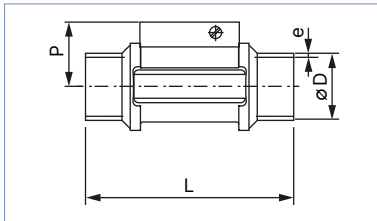

DN	P	Standard	L	ØD	e
08	-	EN ISO 1127/ISO 4200/DIN 11866 series B	-	-	-
	-	SMS 3008	-	-	-
	-	ASME BPE/DIN 11866 series C	-	-	-
	29.5	DIN 11850 series 2/DIN 11866 series A/ DIN EN 10357 series A	96.0	13.00	1.50
15	34.5	EN ISO 1127/ISO 4200/DIN 11866 series B	84.0	21.30	1.60
	-	SMS 3008	-	-	-
	-	ASME BPE/DIN 11866 series C	-	-	-
	34.5	DIN 11850 series 2/DIN 11866 series A/ DIN EN 10357 series A	84.0	19.0	1.50
20	32.0	EN ISO 1127/ISO 4200/DIN 11866 series B	94.0	26.9	1.60
	-	SMS 3008	-	-	-
	34.5	ASME BPE/DIN 11866 series C	84.0	19.05	1.65
	34.5	DIN 11850 series 2/DIN 11866 series A/ DIN EN 10357 series A	84.0	23.00	1.50
25	32.2	EN ISO 1127/ISO 4200/DIN 11866 series B	104.0	33.70	2.00
	32.0	SMS 3008	94.0	25.00	1.20
	32.0	BS 4825-1/ASME BPE/DIN 11866 series C	94.0	25.40	1.65
	32.0	DIN 11850 series 2/DIN 11866 series A/ DIN EN 10357 series A	94.0	29.00	1.50
32	35.8	EN ISO 1127/ISO 4200/DIN 11866 series B	119.0	42.40	2.00
	-	SMS 3008	-	-	-
	32.2	BS 4825-1/ASME BPE/DIN 11866 series C	104.0	32.00	1.65
	32.2	DIN 11850 series 2/DIN 11866 series A/ DIN EN 10357 series A	104.0	35.00	1.50
40	39.6	EN ISO 1127/ISO 4200/DIN 11866 series B	129.0	48.30	2.00
	35.8	SMS 3008	119.0	38.00	1.20
	35.8	BS 4825-1/ASME BPE/DIN 11866 series C	119.0	38.10	1.65
	35.8	DIN 11850 series 2/DIN 11866 series A/ DIN EN 10357 series A	119.0	41.00	1.50
50	45.7	EN ISO 1127/ISO 4200/DIN 11866 series B	148.5	60.30	2.60
	39.6	SMS 3008	128.0	51.00	1.20
	39.6	BS 4825-1/ASME BPE/DIN 11866 series C	128.0	50.80	1.65
	39.6	DIN 11850 series 2/DIN 11866 series A/ DIN EN 10357 series A	128.0	53.00	1.50
65	-	EN ISO 1127/ISO 4200/DIN 11866 series B	-	-	-
	45.7	SMS 3008	147.0	63.50	1.60
	45.7	BS 4825-1/ASME BPE/DIN 11866 series C	147.0	63.50	1.65
	-	DIN 11850 series 2/DIN 11866 series A/ DIN EN 10357 series A	-	-	-

DTS 1000011766 EN Version: AO Status: RL (released | freigegeben | valide) printed: 03.02.2026

Clamp connection

Note:

Dimensions in mm, unless otherwise stated

DIN 32676 series B, SMS 3017¹⁾, BS 4825-3/ASME BPE¹⁾ or DIN 32676 series A in stainless steel (316L - 1.4404)

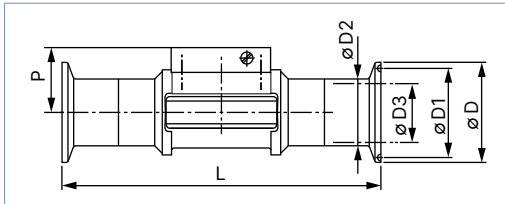

DN	P	Standard	L	ØD	ØD1	ØD2	ØD3
08	-	DIN 32676 series B ²⁾	-	-	-	-	-
	-	SMS 3017	-	-	-	-	-
	-	ASME BPE	-	-	-	-	-
15	29.5	DIN 32676 series A	125	34.0	27.5	13.00	10.00
	34.5	DIN 32676 series B ²⁾	130	34.0	27.5	21.30	18.10
	-	SMS 3017	-	-	-	-	-
20	29.5	DIN 32676 series A	119	34.0	27.5	19.00	16.00
	32.0	DIN 32676 series B	150	50.5	43.5	26.90	23.70
	-	SMS 3017	-	-	-	-	-
25	34.5	ASME BPE	119	25.0	19.6	19.05	15.75
	34.5	DIN 32676 series A	119	34.0	27.5	23.00	20.00
	32.2	DIN 32676 series B	160	50.5	43.5	33.70	29.70
32	32.0	SMS 3017	129	50.5	43.5	25.00	22.60
	32.0	BS 4825-3/ASME BPE	129	50.5	43.5	25.40	22.10
	32.0	DIN 32676 series A	136	50.5	43.5	29.00	26.00
40	35.8	DIN 32676 series B	180	50.5	43.5	42.40	38.40
	-	SMS 3017	-	-	-	-	-
	-	BS 4825-3/ASME BPE	-	-	-	-	-
50	-	DIN 32676 series A	-	-	-	-	-
	39.6	DIN 32676 series B	200	64.0	56.5	48.30	44.30
	35.8	SMS 3017	161	50.5	43.5	38.00	35.60
65	35.8	BS 4825-3/ASME BPE	161	50.5	43.5	38.10	34.80
	35.8	DIN 32676 series A	161	50.5	43.5	41.00	38.00
	45.7	DIN 32676 series B	230	77.5	70.5	60.30	55.10
100	39.6	SMS 3017	192	64.0	56.5	51.00	48.60
	39.6	BS 4825-3/ASME BPE	192	64.0	56.5	50.80	47.50
	39.6	DIN 32676 series A	170	64.0	56.5	53.00	50.00
150	-	DIN 32676 series B	-	-	-	-	-
	45.7	SMS 3017	216	77.5	70.5	63.50	60.3
	45.7	BS 4825-3/ASME BPE	216	77.5	70.5	63.50	60.2
200	-	DIN 32676 series A	-	-	-	-	-

1.) Available with internal surface finish Ra < 0.8 µm

2.) Similar to DIN 32676 series B, but with 34.0 mm clamp connection

Flange connection

Note:

Dimensions in mm, unless otherwise stated

EN1092-1/B1/PN 16, ANSI B16- 5 or JIS 10 K in stainless steel (316L - 1.4404)

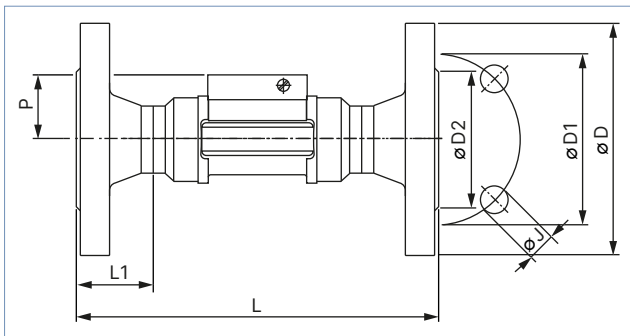

DN	P	Standard	L	L1	ØD	ØD1	ØD2	ØJ
15	34.5	EN	130	23.5	95.0	65.0	45.0	4 × 14.0
		ANSI	130		89.0	60.3	34.9	4 × 15.8
		JIS	152		95.0	70.0	51.0	4 × 15.0
20	32.0	EN	150	28.5	105.0	75.0	58.0	4 × 14.0
		ANSI	150		99.0	69.8	42.9	4 × 15.8
		JIS	178		100.0	75.0	56.0	4 × 15.0
25	32.2	EN	160	28.5	115.0	85.0	68.0	4 × 14.0
		ANSI	160		108.0	79.4	50.8	4 × 15.8
		JIS	216		125.0	90.0	67.0	4 × 19.0
32	35.8	EN	180	31.0	140.0	100.0	78.0	4 × 18.0
		ANSI	180		117.0	88.9	63.5	4 × 15.8
		JIS	229		135.0	100.0	76.0	4 × 19.0
40	39.6	EN	200	36.0	150.0	110.0	88.0	4 × 18.0
		ANSI	200		127.0	98.4	73.0	4 × 15.8
		JIS	241		140.0	105.0	81.0	4 × 19.0
50	45.7	EN	230	41.0	165.0	125.0	102.0	4 × 18.0
		ANSI	230		152.0	120.6	92.1	4 × 19.0
		JIS	267		155.0	120.0	96.0	4 × 19.0

4.2. Plastic sensor-fitting

True union connection with nut and solvent/fusion socket

Note:

Dimensions in mm, unless otherwise stated

DIN 8063, ASTM D 1785/76 or JIS K in PVC DIN 16962 in PP or ISO 10931 in PVDF

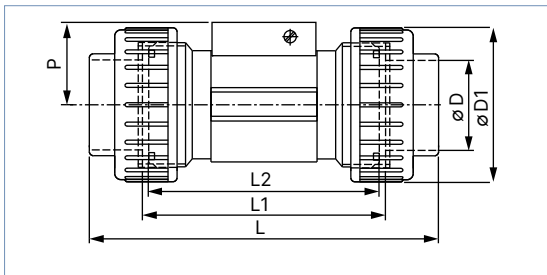

DN	P	Standard	L	L1	L2	ØD	ØD1	
08 ¹⁾	29.5	DIN/ISO	122.0	92	90	12.00	-	
		ASTM	-				-	-
		JIS	-				-	-
15	34.5	DIN/ISO	128.0	96	90	20.00	43	
		ASTM	130.0					21.30
		JIS	129.0					18.40
20	32.0	DIN/ISO	144.0	106	100	25.00	53	
		ASTM	145.6					26.70
		JIS	145.0					26.45
25	32.2	DIN/ISO	160.0	116	110	32.00	60	
		ASTM	161.4					33.40
		JIS	161.0					32.55
32	35.8	DIN/ISO	168.0	116	110	40.00	74	
		ASTM	170.0					42.20
		JIS	169.0					38.60
40	39.6	DIN/ISO	188.0	127	120	50.00	83	
		ASTM	190.2					48.30
		JIS	190.0					48.70
50	45.7	DIN/ISO	212.0	136	130	63.00	103	
		ASTM	213.6					60.30
		JIS	213.0					60.80

1.) Only available in PVC

External thread connection

Note:

Dimensions in mm, unless otherwise stated

G, NPT or Rc in PVC (only DN 06 and DN 08) or PVDF (only DN 08)

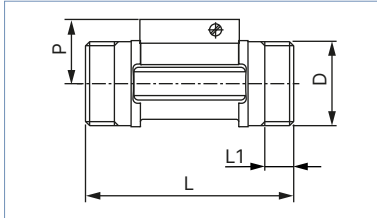

DN	P	L	L1	D
				[inch]
06	29.5	90.0	14.0	G ½
08	29.5	90.0	14.0	G, NPT or Rc ½

Solvent/fusion spigot connection

Note:

Dimensions in mm, unless otherwise stated

DIN 8063 in PVC, DIN 16962 in PP or ISO 10931 in PVDF

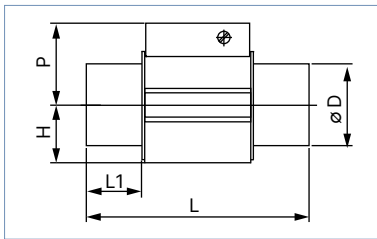

DN	P	Standard	H	L	L1	ØD
15	34.5	DIN 8063	17.5	90	16.5	20
		DIN 16962		85	14.0	
		DIN 10931		85	14.0	
20	32.0	DIN 8063	17.5	100	20.0	25
		DIN 16962		92	16.0	
		DIN 10931		92	16.0	
25	32.2	DIN 8063	21.5	110	23.0	32
		DIN 16962		95	18.0	
		DIN 10931		95	18.0	
32	35.8	DIN 8063	27.5	110	27.5	40
		DIN 16962		100	20.0	
		DIN 10931		100	20.0	
40	39.6	DIN 8063	31.5	120	30.0	50
		DIN 16962		106	23.0	
		DIN 10931		106	23.0	
50	45.7	DIN 8063	39.5	130	37.0	63
		DIN 16962		110	27.0	
		DIN 10931		110	27.0	

5. Performance specifications

5.1. Pressure temperature diagram

With Inline sensor-fitting Type S030 standard

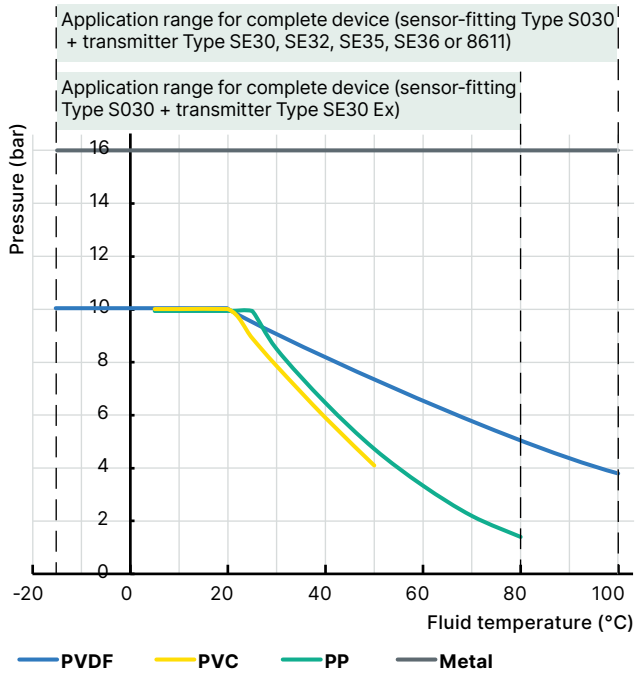

With Inline sensor-fitting Type S030 -HT

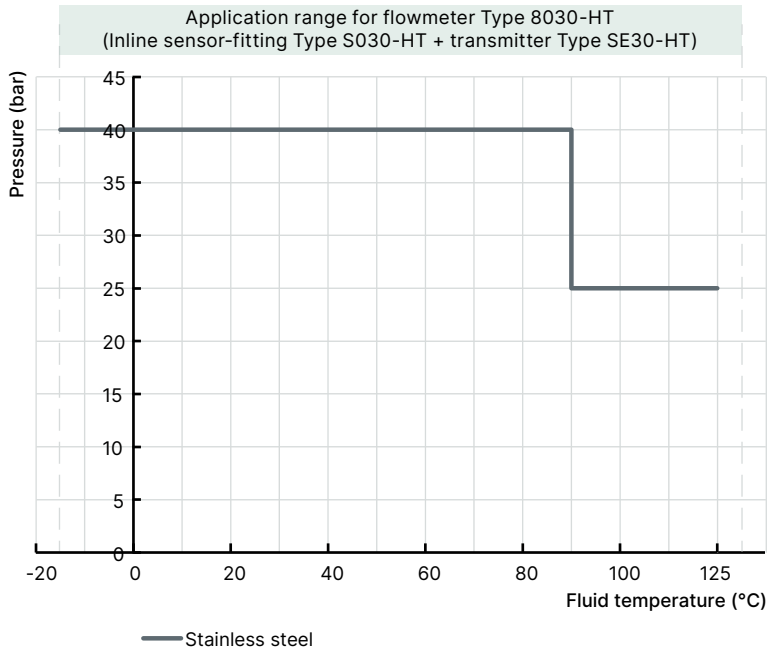

DTS 1000011766 EN Version: AO Status: RL (released | freigegeben | valide) printed: 03.02.2026

6.2. Selection of the nominal diameter

The following graph is used to determine the appropriate DN of the pipe and fitting for the application, according to the fluid velocity and the flow rate. On the chart, the intersection of flow velocity and flow rate gives the appropriate diameter.

Note:

- For the fittings listed below, the corresponding nominal size in the bracket on the graph must be used:
 - External threads acc. to SMS 1145
 - Weld ends acc. to SMS 3008, BS4825-1/ASME BPE/DIN 11866 series C or DIN 11850 series 2/DIN 11866 series A/ DIN EN 10357 series A
 - Clamp acc. to SMS 3017, BS 4825-3/ASME BPE or DIN 32676 series A.
- For all other fittings, the corresponding nominal diameter without bracket applies.

Example 1:

- Nominal flow: 10 m³/h
 - Optimal flow velocity: 2...3 m/s
- Result: select a pipe size of DN 40

Example 2 with external threads according to SMS 1145:

- Nominal flow: 10 m³/h
 - Optimal flow velocity: 2...3 m/s
- Result: select a pipe size of DN 50

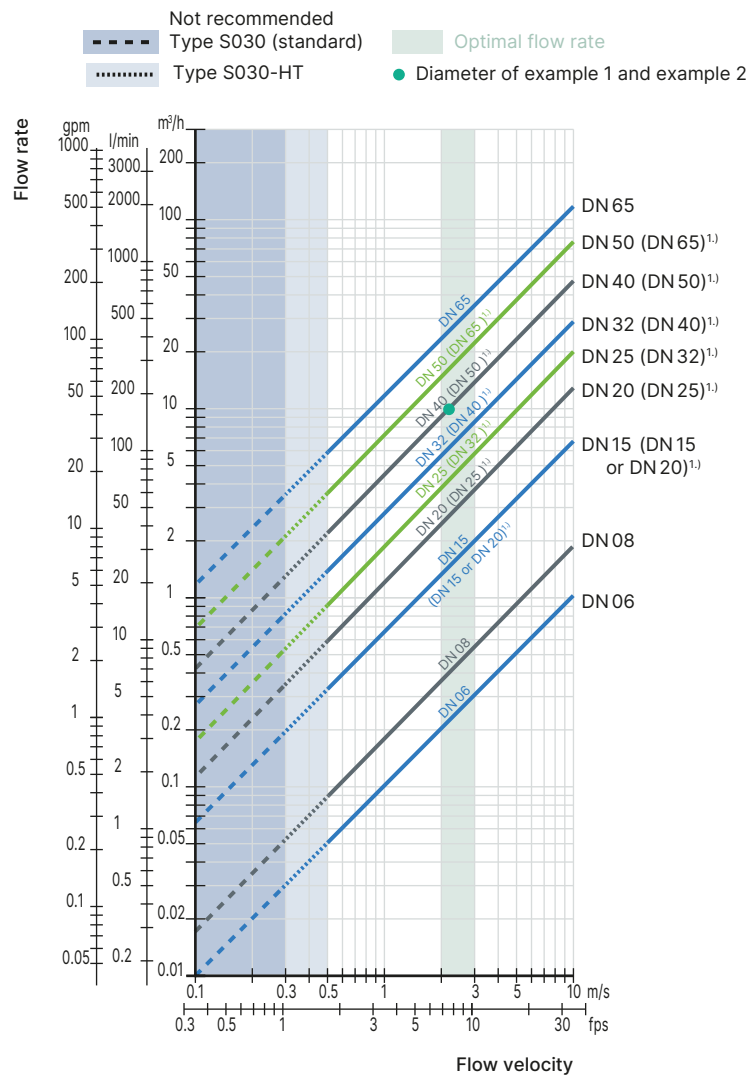

1.) See note at the beginning of this chapter.

7. Product operation

7.1. Measurement principle

When liquid flows through the pipe, the paddle wheel with 4 inserted magnets is set in rotation, producing a frequency signal in the transducer (Hall sensor) of the mounted transmitter. The rotation is detected contactless through the sensor-fitting wall. The frequency of this signal is proportional to the flow velocity of the fluid.

8. Product design and assembly

8.1. Product assembly

Note:

- A complete device to measure the flow rate is made up of an sensor-fitting Type S030 equipped with a paddle wheel sensor and a Bürkert transmitter Type SE30, SE30 Ex, SE32, SE35, SE36 or 8611.
- The sensor-fitting Type S030 ensures simple installation into pipes from DN 06...DN 65. The transmitter Type SE30, SE30 Ex, SE32, SE35, SE36 or 8611 can be mounted on any sensor-fitting Type S030 and fastened with a bayonet catch.
- The drawing shows the assembly of a sensor-fitting Type S030 with a process true union connection with nut and solvent/fusion socket and a transmitter Type SE32 (Type S030 + Type SE32 = Type 8032). This also applies to all variants of process connection and compatible type of transmitter.

See **Data sheet Type 8030** ▶ Inline flowmeter, **Data sheet Type 8032** ▶ Inline flowmeter/threshold detector, **Data sheet Type 8035** ▶ Inline flowmeter or batch controller, **Data sheet Type 8036** ▶ Inline flowmeter, ELEMENT design or **Data sheet Type 8611** ▶ eCONTROL - Universal controller for more information.

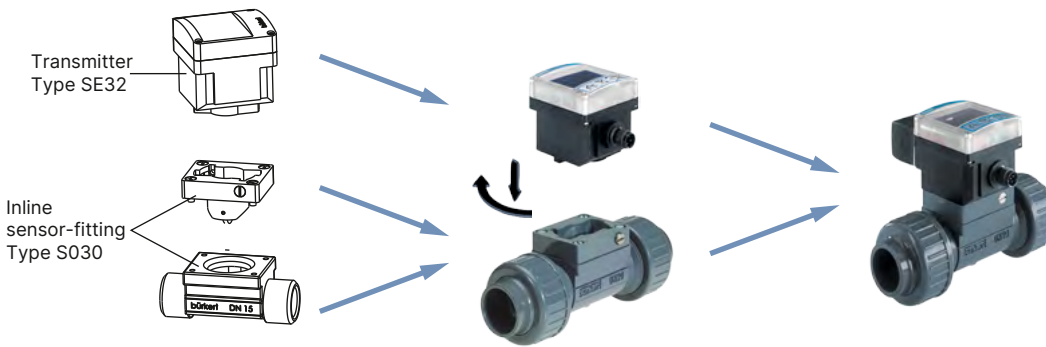

9. Product accessories

Note:

Since March 2012, the Type S030 sensor-fittings in DN 15 and DN 20 have been available in 2 variants with different K factors. Further information can be found in the user manual in the K factor chapter, see **Type S030** ▶/Type S030-HT ▶. The 2nd variant is identified by the “v2” marking. This “v2” marking can be found:

- on the bottom of the DN 15 or DN 20 sensor-fitting in plastic



- on the side of the DN 15 or DN 20 sensor-fitting in metal

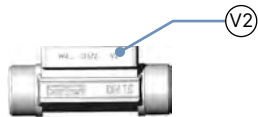

Accessories	No.	Description
	1	Sensor holder
	2	O-ring set for metal sensor-fitting
	3	O-ring set for plastic sensor-fitting: <ul style="list-style-type: none"> • O-rings for process connection (2 seals) • O-ring for fitting body/sensor holder (1 seal¹⁾)

1.) The O-ring is only intended for fitting body with flat bottom groove. The O-ring is not suitable for fitting body with ribbed groove (old variant).

DTS 1000011766 EN Version: AO Status: RL (released | freigegeben | valide) printed: 03.02.2026

10. Networking and combination with other Bürkert products

Example:

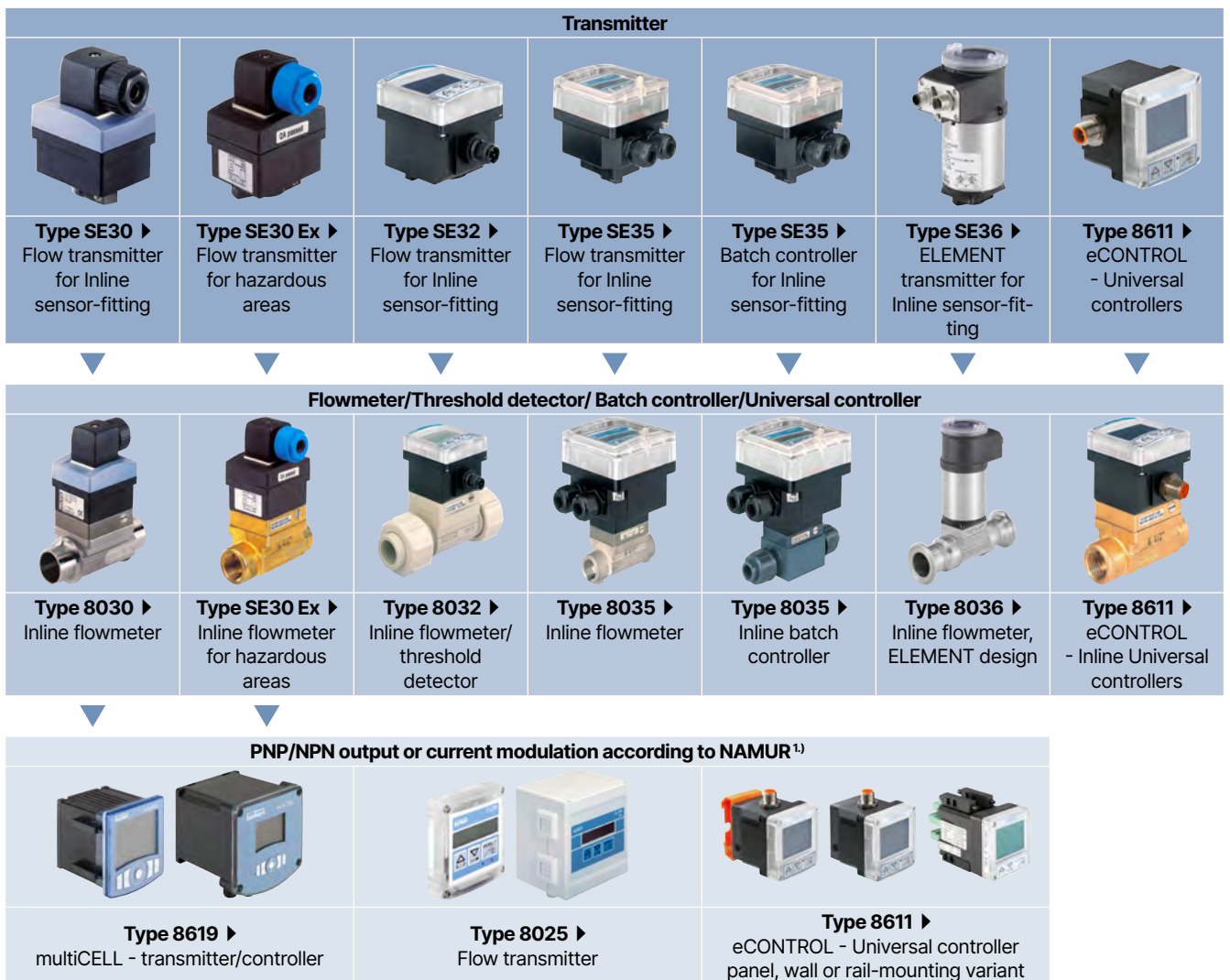

1.) Only for SE30Ex: depending on the category, to be used with an intrinsic safety barrier with NAMUR input

DTS 1000011766 EN Version: AO Status: RL (released | freigegeben | valide) printed: 03.02.2026

11. Ordering information

11.1. Bürkert eShop



Bürkert eShop – Easy ordering and quick delivery

You want to find your desired Bürkert product or spare part quickly and order directly? Our online shop is available for you 24/7. Sign up and enjoy all the benefits.

[Order online now](#)

11.2. Recommendation regarding product selection

A complete device to measure the flow rate is made up of a compact sensor-fitting (Type S030) with paddle wheel and a transmitter (Type SE30, Type SE30 Ex, Type SE32, Type SE35, Type SE36 or Type 8611).

Two different components must be ordered to obtain a complete device. The following information is required:

- **Article no.** of the flow transmitter (see [Data sheet Type 8030](#) ▶, [Data sheet Type 8032](#) ▶, [Data sheet Type 8035](#) ▶, [Data sheet Type 8036](#) ▶ or [Data sheet Type 8611](#) ▶)
- **Article no.** of the Type S030 sensor-fitting (see chapter [“11.4. Ordering chart” on page 19](#))

11.3. Bürkert product filter



Bürkert product filter – Get quickly to the right product

You want to select products comfortably based on your technical requirements? Use the Bürkert product filter and find suitable articles for your application quickly and easily.

[Try out our product filter](#)

11.4. Ordering chart

Metal sensor-fitting

Standard	Article no.									
	DN 06 ¹⁾ - 1/4"	DN 06 ¹⁾ - 1/2"	DN 08 ¹⁾ - 1/2"	DN 15	DN 20	DN 25	DN 32	DN 40	DN 50	DN 65
Brass - with PVDF paddle wheel - Fluid temperature max. 100 °C, PN 16										
FKM seal										
Internal thread connection										
G	-	-	-	423980 ⁷⁾	423981 ⁷⁾	423982 ⁷⁾	423983 ⁷⁾	423984 ⁷⁾	423985 ⁷⁾	-
NPT	-	-	-	423986 ⁷⁾	423987 ⁷⁾	423988 ⁷⁾	423989 ⁷⁾	423990 ⁷⁾	423991 ⁷⁾	-
Rc	-	-	-	423992 ⁷⁾	423993 ⁷⁾	423994 ⁷⁾	423995 ⁷⁾	423996 ⁷⁾	423997 ⁷⁾	-
External thread connection										
G	552557 ⁷⁾	552527 ⁷⁾	444023 ⁷⁾	423998 ⁷⁾	423999 ⁷⁾	424000 ⁷⁾	424001 ⁷⁾	-	-	-
NPT	-	-	449182 ⁷⁾	-	-	-	-	-	-	-
Rc	-	-	448668 ⁷⁾	-	-	-	-	-	-	-
Stainless steel - with PVDF paddle wheel - Fluid temperature max. 100 °C, PN 16										
FKM seal										
Internal thread connection										
G	-	-	-	424004 ⁷⁾	424005 ⁷⁾	424006 ⁷⁾	424007 ⁷⁾	424008 ⁷⁾	424009 ⁷⁾	-
NPT	-	-	-	424010 ⁷⁾	424011 ⁷⁾	424012 ⁷⁾	424013 ⁷⁾	424014 ⁷⁾	424015 ⁷⁾	-
Rc	-	-	-	424016 ⁷⁾	424017 ⁷⁾	424018 ⁷⁾	424019 ⁷⁾	424020 ⁷⁾	424021 ⁷⁾	-
External thread connection										
G	552733 ⁷⁾	552559 ⁷⁾	444029 ⁷⁾	424022 ⁷⁾	424023 ⁷⁾	424024 ⁷⁾	424025 ⁷⁾	-	-	-
NPT	-	-	449050 ⁷⁾	-	-	-	-	-	-	-
Rc	-	-	448669 ⁷⁾	-	-	-	-	-	-	-
Weld end spigot connection										
EN ISO 1127/ ISO 4200/ DIN 11866 series B	-	-	552845 ⁷⁾ ³⁾	424028 ⁷⁾	424029 ⁷⁾	424030 ⁷⁾	424031 ⁷⁾	424032 ⁷⁾	424033 ⁷⁾	-
Clamp connection										
DIN 32676 series B	-	-	-	424034 ⁷⁾ ⁴⁾	424035 ⁷⁾	424036 ⁷⁾	424037 ⁷⁾	424038 ⁷⁾	424039 ⁷⁾	-
Flange connection										
EN 1092-1/B1/PN 16	-	-	-	424040 ⁷⁾	424041 ⁷⁾	424042 ⁷⁾	424043 ⁷⁾	424044 ⁷⁾	424045 ⁷⁾	-
ANSI B16- 5	-	-	-	424046 ⁷⁾	424047 ⁷⁾	424048 ⁷⁾	424049 ⁷⁾	424050 ⁷⁾	424051 ⁷⁾	-
JIS 10K	-	-	-	430108 ⁷⁾	430109 ⁷⁾	430110 ⁷⁾	430111 ⁷⁾	430112 ⁷⁾	430113 ⁷⁾	-
EPDM seal										
External thread connection										
SMS 1145	-	-	-	-	-	443306 ⁷⁾	-	443307 ⁷⁾	443308 ⁷⁾	-
Weld end spigot connection										
SMS 3008	-	-	-	-	-	443298 ⁷⁾	-	443299 ⁷⁾	443300 ⁷⁾	443374 ⁷⁾ ⁶⁾
BS 4825-1/ ASME BPE/ DIN 11866 series C	-	-	-	-	443369 ⁷⁾ ⁵⁾	443370 ⁷⁾	443371 ⁷⁾	443372 ⁷⁾	443373 ⁷⁾	443374 ⁷⁾
DIN 11850 series 2/ DIN 11866 series A/ DIN EN 10357 series A	-	-	551788 ⁷⁾	551789 ⁷⁾	551790 ⁷⁾	551791 ⁷⁾	-	551792 ⁷⁾	551793 ⁷⁾	-
Clamp connection										
SMS 3017	-	-	-	-	-	443302 ⁷⁾	-	443303 ⁷⁾	443304 ⁷⁾	443399 ⁷⁾ ⁶⁾
SMS 3017 ²⁾	-	-	-	-	-	443387 ⁷⁾	-	443388 ⁷⁾	443389 ⁷⁾	443720 ⁷⁾ ⁶⁾
BS 4825-3/ ASME BPE	-	-	-	-	443395 ⁷⁾ ⁵⁾	443396 ⁷⁾	-	443397 ⁷⁾	443398 ⁷⁾	443399 ⁷⁾
BS 4825-3/ ASME BPE ²⁾	-	-	-	-	443400 ⁷⁾	443717 ⁷⁾	-	443718 ⁷⁾	443719 ⁷⁾	443720 ⁷⁾
DIN 32676 series A	-	-	551794 ⁷⁾ ⁴⁾	551795 ⁷⁾ ⁴⁾	551796 ⁷⁾	551797 ⁷⁾	-	551798 ⁷⁾	551799 ⁷⁾	-

DTS 1000011766 EN Version: AO Status: RL (released | freigegeben | valide) printed: 03.02.2026

Standard	Article no.									
	DN 06 ¹⁾ - ¼"	DN 06 ¹⁾ - ½"	DN 08 ¹⁾ - ½"	DN 15	DN 20	DN 25	DN 32	DN 40	DN 50	DN 65
Stainless steel - with PVDF paddle wheel - Fluid temperature max. 100 °C, PN 40										
FKM seal										
Internal thread connection										
G	-	-	-	427138 𐀀	425737 𐀀	425729 𐀀	427152 𐀀	427153 𐀀	427154 𐀀	-

- 1.) External thread
- 2.) Internal surface finish Ra < 0.8 µm
- 3.) EPDM seal
- 4.) Refer to clamp with D dimensions of 34 mm (see chapter "Clamp connection" on page 10)
- 5.) DN 20 (¾") only available in ASME BPE
- 6.) Refer to ASME BPE

Further variants on request

Process connection
 External thread connection: Metric in mm

Plastic sensor-fitting

Standard	Article no.									
	DN 06 ¹⁾ - ¼"	DN 06 ¹⁾ - ½"	DN 08 ¹⁾ - ½"	DN 15	DN 20	DN 25	DN 32	DN 40	DN 50	DN 65
PVC - with PVDF paddle wheel - Fluid temperature max. 50 °C, PN 10										
FKM seal										
True union connection with nut and solvent socket										
DIN 8063	-	-	444022 𐀀	423938 𐀀	423939 𐀀	423940 𐀀	423941 𐀀	423942 𐀀	423943 𐀀	-
ASTM D 1785/76	-	-	-	423950 𐀀	423951 𐀀	423952 𐀀	423953 𐀀	423954 𐀀	423955 𐀀	-
JIS K	-	-	-	429072 𐀀	429073 𐀀	429074 𐀀	429075 𐀀	429076 𐀀	429077 𐀀	-
External thread connection										
G	-	552560 𐀀	444025 𐀀	-	-	-	-	-	-	-
Solvent spigot connection										
DIN 8063	-	-	-	423944 𐀀	423945 𐀀	423946 𐀀	423947 𐀀	423948 𐀀	423949 𐀀	-
True union connection with nut and without socket										
-	-	-	-	430734 𐀀	430735 𐀀	430736 𐀀	430737 𐀀	430738 𐀀	430739 𐀀	-
EPDM seal										
True union connection with nut and without socket										
-	-	-	-	430740 𐀀	430741 𐀀	430742 𐀀	430743 𐀀	430744 𐀀	430745 𐀀	-
PP - with PVDF paddle wheel - Fluid temperature max. 80 °C, PN 10										
FKM seal										
True union connection with nut and fusion socket										
DIN 16962	-	-	-	423956 𐀀	423957 𐀀	423958 𐀀	423959 𐀀	423960 𐀀	423961 𐀀	-
Fusion spigot connection										
DIN 16962	-	-	-	423962 𐀀	423963 𐀀	423964 𐀀	423965 𐀀	423966 𐀀	423967 𐀀	-
PVDF - with PVDF paddle wheel - Fluid temperature max. 100 °C, PN 10										
FKM seal										
True union connection with nut and fusion socket										
ISO 10931	-	-	-	423968 𐀀	423969 𐀀	423970 𐀀	423971 𐀀	423972 𐀀	423973 𐀀	-
External thread connection										
ISO 10931	-	-	444028 𐀀	-	-	-	-	-	-	-
Fusion spigot connection										
ISO 10931	-	-	-	423974 𐀀	423975 𐀀	423976 𐀀	423977 𐀀	423978 𐀀	423979 𐀀	-

- 1.) External thread

DTS 1000011766 EN Version: AO Status: RL (released | freigegeben | valide) printed: 03.02.2026

Stainless steel sensor-fitting (S030-HT variant)

Note:

Only mount with transmitter Type SE30 in variant High Temperature (Type SE30-HT). This combination gives the High Temperature flowmeter variant (Type 8030-HT), see **data sheet Type 8030** ▶.

Standard	Article no.							
	DN 06 ¹⁾ -1/4"	DN 08 ¹⁾ -1/2"	DN 15	DN 20	DN 25	DN 32	DN 40	DN 50
With stainless steel paddle wheel - Fluid temperature max. 125 °C, PN 25 (max. 90 °C, PN 40)								
FKM seal								
Internal thread connection								
G	-	-	449726	449727	449728	449729	449730	449731
NPT	-	-	449733	449734	449735	449736	449737	449738
Rc	-	-	449740	449741	449742	449743	449744	449745
External thread connection								
G	552735	449725	-	-	-	-	-	-
NPT	-	449732	-	-	-	-	-	-
Rc	-	449739	-	-	-	-	-	-
Weld end connection								
EN ISO 1127/ISO 4200/DIN 11866 series B	-	-	551757	551758	551759	551760	551761	551762

1.) External thread

Further variants on request	
Material EPDM seal	Process connection Clamp or flange

11.5. Ordering chart accessories

Note:

Since March 2012, the Type S030 sensor-fittings in DN 15 and DN 20 exist in 2 variants, with different K factors. The 2nd variant is identified by the "v2" marking.

See chapter "9. Product accessories" on page 16.

Description	Article no.
Sensor armature set	
Sensor armature made of stainless steel with paddle wheel (PVDF), seal (FKM), screws and test certificate for DN 06, DN 08, DN 15 v2 and DN 20 v2	448678
Sensor armature made of stainless steel with paddle wheel (PVDF), seal (FKM), screws and test certificate for DN 15 (except DN 15 v2 and DN 20 v2)...DN 65	432306
Sensor armature made of stainless steel with paddle wheel (PVDF), seal (EPDM), screws and test certificate for DN 15 (except DN 15 v2 and DN 20 v2)...DN 65	432305
Sensor armature made of stainless steel with paddle wheel (PVDF), seal (EPDM), screws and test certificate, Ra int. < 0.8 µm for DN 15 (except DN 15 v2 and DN 20 v2)...DN 65	434149
Sensor armature made of stainless steel with paddle wheel (PP), seal (EPDM), screws and test certificate for DN 06, DN 08, DN 15 v2 and DN 20 v2	554896
Sensor armature made of stainless steel with paddle wheel (PP), seal (EPDM), screws and test certificate for DN 15 (except DN 15 v2 and DN 20 v2)...DN 65	449425
Sensor armature made of brass with paddle wheel (PVDF), seal (FKM), screws and test certificate for DN 06, DN 08, DN 15 v2 and DN 20 v2	448677
Sensor armature made of brass with paddle wheel (PVDF), seal (FKM), screws and test certificate for DN 15 (except DN 15 v2 and DN 20 v2)...DN 65	432304
Sensor armature made of brass with paddle wheel (PVDF), seal (EPDM), screws and test certificate for DN 15 (except DN 15 v2 and DN 20 v2)...DN 65	432303
Sensor armature made of brass with paddle wheel (PP), seal (EPDM), screws and test certificate for DN 15 (except DN 15 v2 and DN 20 v2)...DN 65	449866
Sensor armature made of PVC with paddle wheel (PVDF), seal ¹⁾ (FKM), screws and test certificate for DN 06, DN 08, DN 15 v2 and DN 20 v2	448674

Sensor armature made of PVC with paddle wheel (PVDF), seal ¹⁾ (FKM), screws and test certificate for DN 15 (except DN 15 v2 and DN 20 v2)...DN 65		432298
Sensor armature made of PVC with paddle wheel (PVDF), seal ¹⁾ (EPDM), screws and test certificate for DN 15 (except DN 15 v2 and DN 20 v2)...DN 65		432297
Sensor armature made of PVC with paddle wheel (PP), seal ¹⁾ (EPDM), screws and test certificate for DN 15 (except DN 15 v2 and DN 20 v2)...DN 65		443982
Sensor armature made of PP with paddle wheel (PVDF), seal ¹⁾ (FKM), screws and test certificate for DN 15...DN 65		432300
Sensor armature made of PP with paddle wheel (PVDF), seal ¹⁾ (EPDM), screws and test certificate for DN 15...DN 65		432299
Sensor armature made of PP with paddle wheel (PP), seal ¹⁾ (FKM), screws and test certificate for DN 15...DN 65		552881
Sensor armature made of PP with paddle wheel (PP), seal ¹⁾ (EPDM), screws and test certificate for DN 15...DN 65		443983
Sensor armature made of PVDF with paddle wheel (PVDF), seal ¹⁾ (FKM), screws and test certificate for DN 06, DN 08, DN 15 v2 and DN 20 v2		448676
Sensor armature made of PVDF with paddle wheel (PVDF), seal ¹⁾ (FKM), screws and test certificate for DN 15 (except DN 15 v2 and DN 20 v2)...DN 65		432302
Sensor armature made of PVDF with paddle wheel (PVDF), seal ¹⁾ (EPDM), screws and test certificate for DN 15 (except DN 15 v2 and DN 20 v2)...DN 65		432301
Sensor armature set for High Temperature variant		
Sensor armature made of stainless steel with paddle wheel (stainless steel), seal (FKM) and screws for DN 15 (except DN 15 v2 and DN 20 v2)...DN 50		551764
Sensor armature made of stainless steel with paddle wheel (stainless steel), seal (FKM) and screws for DN 06, DN 08, DN 15 v2 and DN 20 v2		449723
Sensor armature made of stainless steel with paddle wheel (stainless steel), seal (EPDM) and screws for DN 15 (except DN 15 v2 and DN 20 v2)...DN 50		551763
Sensor armature in stainless steel with paddle wheel (stainless steel), seal (EPDM) and screws for DN 06, DN 08, DN 15 v2 and DN 20 v2		449724
Seal set		
O-ring made of FKM for metal fitting, DN 06...DN 65		426340
O-ring made of EPDM for metal fitting, DN 06...DN 65		426341
O-ring made of FKM for plastic fitting ¹⁾	DN 08	448679
	DN 15	431555
	DN 20	431556
	DN 25	431557
	DN 32	431558
	DN 40	431559
O-ring made of EPDM for plastic fitting ¹⁾	DN 50	431560
	DN 08	448680
	DN 15	431561
	DN 20	431562
	DN 25	431563
	DN 32	431564
DN 40	431565	
DN 50	431566	
Approvals and conformities		
3-point flow calibration certificate ²⁾		550676
Inspection certificate 3.1 (according to EN-ISO 10204)		803723
Test report 2.2 (according to EN-ISO 10204)		803722
Certification of conformity for the surface finish (according to DIN4762, DIN4768, ISO/4287/1)		804175
FDA declaration of conformity		803724

1.) The O-ring is only intended for fitting body with flat bottom groove. The O-ring is not suitable for fitting body with ribbed groove (old variant).

2.) Type S030 combined with the plugged-in flow transmitter, only for DN ≤ 200.

DTS 1000011766 EN Version: AO Status: RL (released | freigegeben | valide) printed: 03.02.2026