



带Kick and Drop 线圈的电磁阀

- 线圈中的两个绕组用环氧树脂封装
- 在较小的结构体积下，提升了电磁阀的整体性能和更高的内孔压力比
- 保持功率降至 1 W 以下，节能 80% 以上
- 减少线圈发热，减少钙化，延长使用寿命
- 内部电子组件兼容直流和交流电压

数据表中所述的产品型号可能与产品介绍及说明中的产品型号有所不同。

可与以下产品组合使用

	6013 型 直动式二位二通电磁阀	▶
	6014 型 直动式二位三通电磁阀	▶
	6027 型 直动式二位二通电磁阀	▶
	6213 型 伺服辅助式二位二通隔膜阀	▶
	6281 型 伺服辅助式二位二通隔膜阀	▶
	5404 型 伺服辅助式二位二通活塞阀	▶
	6240 型 伺服辅助式二位二通活塞阀	▶

型号说明

AC10 和 AC19 型的 Kick and Drop 线圈使用两个绕组。由于增加了第一绕组的涌流功率，在不改变电磁阀整体安装体积的情况下，可切换更高的介质压力。第二个绕组在通电 500 ms 后由于保持力的降低，减少电磁阀发热，从而节约能源。

内容

1. 常规技术参数	3
2. 回路功能	4
3. 认证和符合性	4
3.1. 一般说明	4
3.2. 符合性	4
3.3. 标准	4
3.4. 防爆	5
3.5. 北美 (美国/加拿大)	5
4. 材料	6
4.1. Bürkert resistApp	6
4.2. 材料说明	6
5. 尺寸	7
5.1. AC10 标准版本	7
5.2. AC19 标准版本	7
6. 功率说明	8
6.1. 温度图	8
最高环境温度	8
最高表面温度	8
7. 订货信息	9
7.1. Bürkert 网上商店	9
7.2. Bürkert 产品选型	9
7.3. Kick and Drop 线圈套件订货表	9
7.4. 6013 型订货表, 带 Kick and Drop 线圈	10
7.5. 6014 型订货表, 带 Kick and Drop 线圈	11
7.6. 6026 型订货表, 带 Kick and Drop 线圈	12
7.7. 6027 型订货表, 带 Kick and Drop 线圈	13
7.8. 6213 型订货表, 带 Kick and Drop 线圈	14
7.9. 6281 型订货表, 带 Kick and Drop 线圈	15
7.10. 5404 型订货表, 带 Kick and Drop 线圈	16
7.11. 6240 型订货表, 带 Kick and Drop 线圈	17
7.12. 6407 型订货表, 带 Kick and Drop 线圈	18
7.13. 配件订货表	19
2518 型设备插口, A 型插头, 符合 DIN EN 175301-803 标准	19
2509 型设备插口, A 型插头, 符合 DIN EN 175301-803 标准	19

1. 常规技术参数

产品特征		
尺寸	更多信息, 请参见章节“5. 尺寸”在第 7 页。	
材料¹⁾		
密封件	FKM	
线圈	环氧树脂	
回路功能	A、B、C 和 D 更多信息, 请参见章节“2. 回路功能”在第 4 页。	
电磁线圈的绝缘等级	环氧树脂线圈 H 级	
性能数据		
开关频率		
AC10	最大 30 次开关/分钟	
AC19	最大 30 次开关/分钟	
电气参数		
工作电压	24 V/50~60 Hz 和 24 V/DC, 110~120 V/50~60 Hz, 230~240 V/50~60 Hz	
单阀负载周期	连续运行 100% ED	
电压允差	±10%	
过程接口/管道接口和通信		
电气连接	<ul style="list-style-type: none"> 符合 DIN EN 175 301-803 A 型标准的插头接线片, 适用于 2518 型设备插口 ▶。 更多信息, 请参见章节“2518 型设备插口, A 型插头, 符合 DIN EN 175301-803 标准”在第 19 页。 符合 DIN EN 175301-803 A 型标准的插头接线片, 适用于 2509 型设备插口 ▶。 更多信息, 请参见章节“2509 型设备插口, A 型插头, 符合 DIN EN 175301-803 标准”在第 19 页。 对于 AC19, ATEX/IECEx 版本带电缆或接线盒 	
认证和符合性		
防尘防水	IP65, 带设备插口 IP67, 带 2518 型设备插口 (可用版本参见 2518 型数据表 ▶)	
防爆	更多信息, 请参见章节“3.4. 防爆”在第 5 页。	
北美 (美国/加拿大)	更多信息, 请参见章节“3.5. 北美 (美国/加拿大)”在第 5 页。	
环境与安装		
环境温度²⁾		
AC10	30 次开关/分钟	1 次开关/分钟
12/0.6 W	最高 70 °C	最高 85 °C
20/2.0 W	最高 70 °C	最高 85 °C
65/7.0 W	最高 55 °C	最高 70 °C
AC19	30 次开关/分钟	1 次开关/分钟
44/6.5 W	最高 70 °C	最高 85 °C 标准/70 °C ATEX 类别2
85/8.5 W	最高 55 °C	最高 70 °C

1.) 由于采用插入式线圈系统, 以下材料不与介质接触。

2.) 温度信息对应于给定的可控压力差。更高的温度取决于压力差、负载周期和开关次数, 可按要求提供。更多信息, 请参见章节“6.1. 温度图”在第 8 页。

2. 回路功能

符号	说明
	回路功能 A (WW A) 二位二通电磁阀 直动式 在断电位置关闭
	回路功能 B (WW B) 二位二通电磁阀 直动式 在断电位置打开
	回路功能 C (WW C) 二位三通电磁阀 直动式 在断电位置关闭
	回路功能 D (WW D) 二位三通电磁阀 直动式 在断电位置打开

3. 认证和符合性

3.1. 一般说明

- 查询时，必须指出以下所述认证或符合性。只有这样，我们才能确保产品满足所有规定的性能。
- 并非所有可订购的设备版本都会提供以下所述认证或符合性。



3.2. 符合性

根据欧盟符合性声明，产品符合欧盟指令。



3.3. 标准

用于证明其符合欧盟指令的适用标准可以在欧盟型式检验证书和/或欧盟符合性声明中找到。

3.4. 防爆

认证	说明														
 	<p>可选 (适用于 AC19 KD 线圈) : 防爆符合 2 类 (1/21 区)</p> <p>组件的 Ex 标识符合下表:</p> <table border="1"> <thead> <tr> <th colspan="2">AC19 型线圈</th> </tr> <tr> <th>带接出电缆的线圈</th> <th>带接线盒的线圈</th> </tr> </thead> <tbody> <tr> <td> ATEX: EPS 16 ATEX 1 072 X II 2 G Ex mb IIC T4 Gb II 2 D Ex mb IIIC T130 °C Db </td> <td> ATEX: EPS 16 ATEX 1 072 X II 2 G Ex eb mb IIC T4 Gb II 2 D Ex mb tb IIIC T130 °C Db </td> </tr> </tbody> </table> <p>可选: 防爆符合 3 类 (2/22 区)</p> <p>组件的 Ex 标识符合下表:</p> <table border="1"> <thead> <tr> <th colspan="2">带 A 型插头接线片和 2509 型设备插口的线圈</th> </tr> <tr> <th>AC10 型线圈</th> <th>AC19 型线圈</th> </tr> </thead> <tbody> <tr> <td> ATEX: EPS 21 ATEX 1234 X II 3G Ex ec IIC T4 Gc II 3D Ex tc IIIC T135 °C Dc </td> <td> ATEX: EPS 22 ATEX 1136 X II 3G Ex ec IIC T3 Gc II 3D Ex tc IIIC T200 °C Dc </td> </tr> <tr> <td> IECEx: IECEx EPS 21.0078 X Ex ec IIC T4 Gc Ex tc IIIC T135 °C Dc </td> <td> IECEx: IECEx EPS 22.0018 X Ex ec IIC T3 Gc Ex tc IIIC T200 °C Dc </td> </tr> </tbody> </table>	AC19 型线圈		带接出电缆的线圈	带接线盒的线圈	ATEX: EPS 16 ATEX 1 072 X II 2 G Ex mb IIC T4 Gb II 2 D Ex mb IIIC T130 °C Db	ATEX: EPS 16 ATEX 1 072 X II 2 G Ex eb mb IIC T4 Gb II 2 D Ex mb tb IIIC T130 °C Db	带 A 型插头接线片和 2509 型设备插口的线圈		AC10 型线圈	AC19 型线圈	ATEX: EPS 21 ATEX 1234 X II 3G Ex ec IIC T4 Gc II 3D Ex tc IIIC T135 °C Dc	ATEX: EPS 22 ATEX 1136 X II 3G Ex ec IIC T3 Gc II 3D Ex tc IIIC T200 °C Dc	IECEx: IECEx EPS 21.0078 X Ex ec IIC T4 Gc Ex tc IIIC T135 °C Dc	IECEx: IECEx EPS 22.0018 X Ex ec IIC T3 Gc Ex tc IIIC T200 °C Dc
	AC19 型线圈														
带接出电缆的线圈	带接线盒的线圈														
ATEX: EPS 16 ATEX 1 072 X II 2 G Ex mb IIC T4 Gb II 2 D Ex mb IIIC T130 °C Db	ATEX: EPS 16 ATEX 1 072 X II 2 G Ex eb mb IIC T4 Gb II 2 D Ex mb tb IIIC T130 °C Db														
带 A 型插头接线片和 2509 型设备插口的线圈															
AC10 型线圈	AC19 型线圈														
ATEX: EPS 21 ATEX 1234 X II 3G Ex ec IIC T4 Gc II 3D Ex tc IIIC T135 °C Dc	ATEX: EPS 22 ATEX 1136 X II 3G Ex ec IIC T3 Gc II 3D Ex tc IIIC T200 °C Dc														
IECEx: IECEx EPS 21.0078 X Ex ec IIC T4 Gc Ex tc IIIC T135 °C Dc	IECEx: IECEx EPS 22.0018 X Ex ec IIC T3 Gc Ex tc IIIC T200 °C Dc														

3.5. 北美 (美国/加拿大)

认证	说明
	<p>可选 (适用于 AC19 KD 线圈) : UL 危险场所——防爆</p> <p>美国和加拿大危险场所 UL 认证 Class I, Zone 1 Class I, Division 2, Groups A、B、C 和 D Class II+III, Division 2, Group F 和 G</p>
	<p>适用于线圈: 美国和加拿大 UL 认证</p> <p>线圈获得美国和加拿大 UL 认证, 根据:</p> <ul style="list-style-type: none"> • UL 429 (电动阀) • CAN/CSA-C22.2 No.139

DTS 1000632946 ZH Version: A Status: RL (released | freigegeben | valide) printed: 14.04.2025

4. 材料

4.1. Bürkert resistApp



Bürkert resistApp——耐化学性表

您想在个人应用情况下保证材料的可靠性和耐久性吗？在我们的网页上或在 resistApp 中验证您的介质和材料组合。

[立即检验耐化学性](#)

4.2. 材料说明

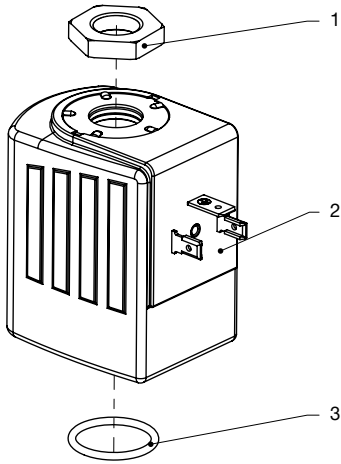

编号	元件	材料
1	螺母	DIN 176 厚膜钝化或不锈钢
2	线圈	环氧树脂
3	密封件	FKM

5. 尺寸

5.1. AC10 标准版本

注意：
尺寸 mm

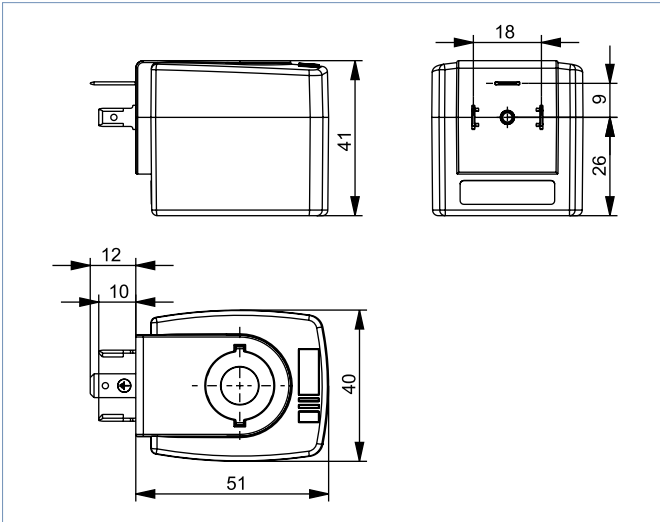

5.2. AC19 标准版本

注意：
尺寸 mm

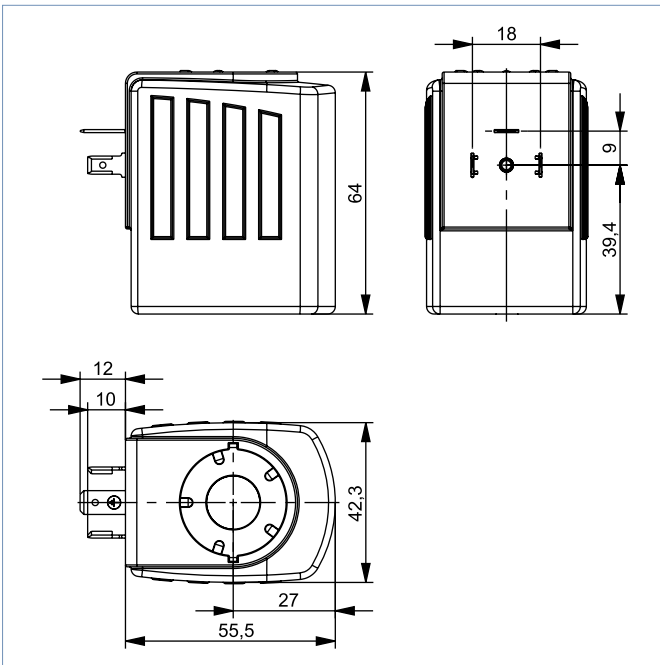

6. 功率说明

6.1. 温度图

最高环境温度

最高环境温度取决于功率等级和最大负载周期下的每分钟开关次数。

AC10 型

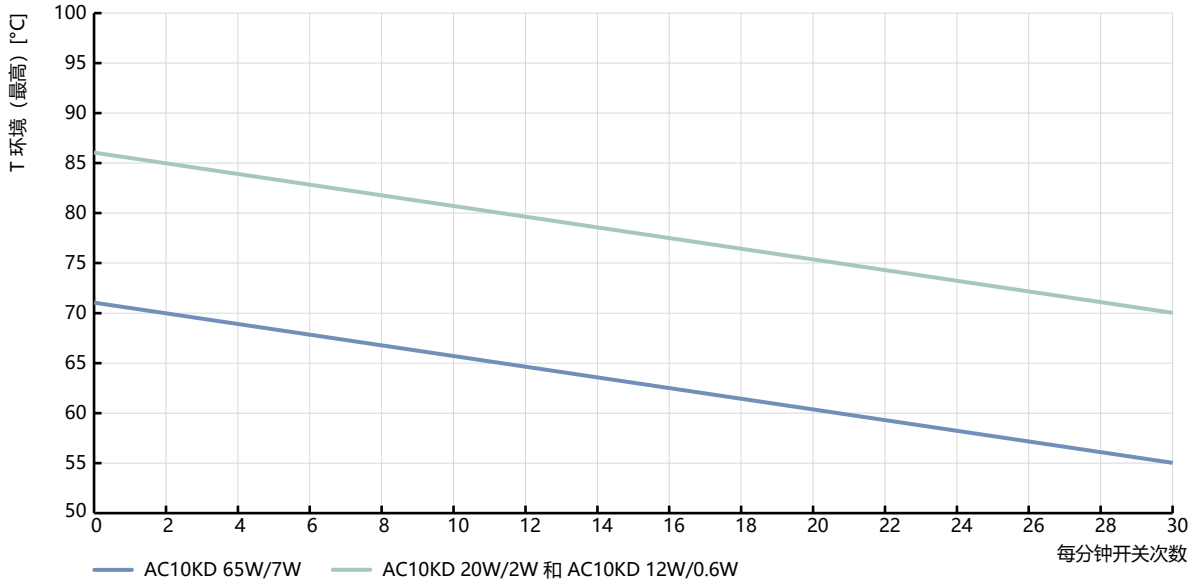

最高表面温度

最高表面温度取决于功率等级和 100% 负载周期下的环境温度。

AC10 型

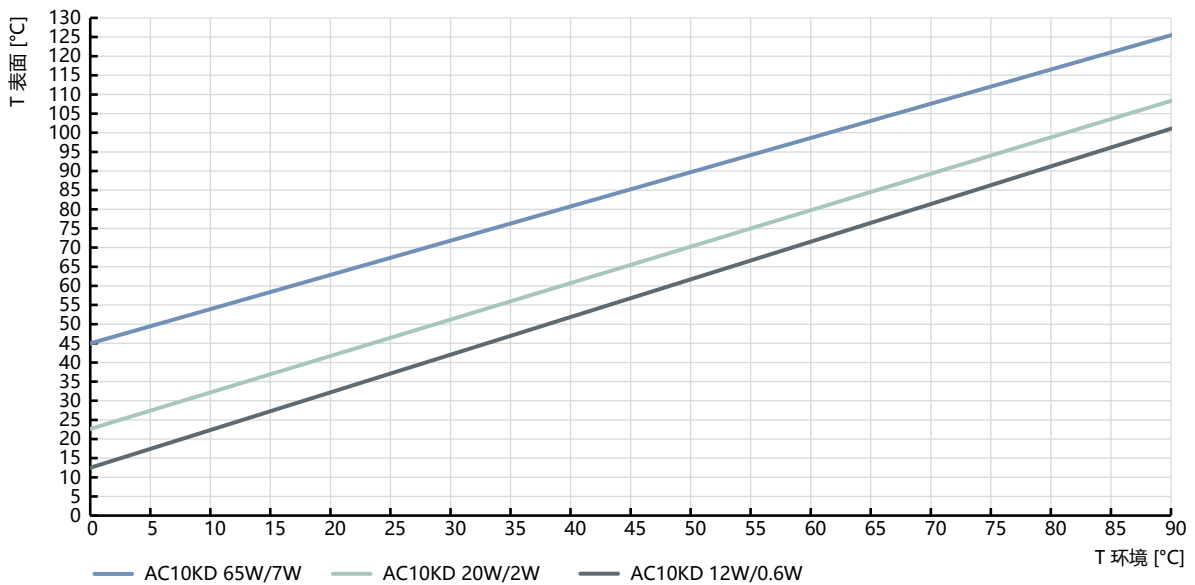

7. 订货信息

7.1. Bürkert 网上商店



Bürkert 网上商店——轻松订购、快速送达

您想快速查找并直接订购您所需的 Bürkert 产品或备件吗？我们的网上商店全天 24 小时开放。立即注册享受便利。

立即在线订购

7.2. Bürkert 产品选型

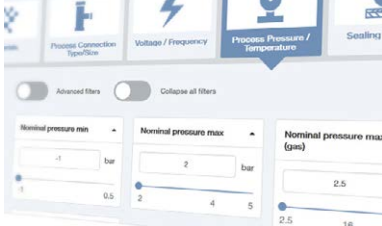

Bürkert 产品选型——快速找到合适的产品

您想要基于您的技术需求选择合适的产品吗？利用 Bürkert 产品选型，查找匹配您应用的合适产品。

立即筛选产品

7.3. Kick and Drop 线圈套件订货表

注意：

- 作为替换件或用作加装件
- 该套件包括 Kick and Drop 线圈、密封件和紧固螺母。
- 具有其他电压的更多版本可应要求提供。

线圈型号	建议的电磁阀 ¹⁾	电气连接	线圈功率		订货号	
			吸合功率 [W]	吸持功率 [W]	24/AC/DC [V/Hz]	230/AC [V/Hz]
AC10 40 mm	6013、6014、6281、 5404、6240 DN 6	DIN EN 175 301-803, A 型	12	0.6	20044994 𠄎	—
		DIN EN 175 301-803, A 型	20	2	20045040 𠄎	20045049 𠄎
		DIN EN 175 301-803, A 型	65	7	20045051 𠄎	20045062 𠄎
AC19 42 mm	6026、6027、6407、 6240 DN 12	DIN EN 175 301-803, A 型	44	6.5	350043 𠄎	389296 𠄎
		ATEX/IECEx 电缆	44	6.5	389296 𠄎	389297 𠄎
		ATEX/IECEx 接线盒	44	6.5	389298 𠄎	389299 𠄎
		DIN EN 175 301-803, A 型	85	8.5	338843 𠄎	338845 𠄎

— = 不可用

1.) 使用保证取决于相应的版本，并且只能在咨询您的 Bürkert 联系人后才能确定。

DTS 1000632946 ZH Version: A Status: RL (released | freigegeben | valide) printed: 14.04.2025

7.4. 6013 型订货表, 带 Kick and Drop 线圈

6013 型阀门是直动式二位二通电磁阀。Kick and Drop 线圈可将吸持功率降低至 10 瓦 (具体取决于版本), 并增加常闭版本的压力范围。



注意:

- 有关电磁阀的更多信息, 请参见 6013 型数据表 ▶。
- 其他版本带不锈钢阀体无短路环、其他电压、NPT 或 RC 内螺纹、法兰版本或其他密封材料, 可应要求提供。

回路功能	管道接口	通径 [mm]	K _v 值 (水) [m ³ /h]	线圈功率		压力范围 [bar]	订货号		
				吸合功率 [W]	吸持功率 [W]		24/AC/DC [V/Hz]	230~240/AC [V/Hz]	
黄铜阀体, G 内螺纹, FKM/FKM 密封材料									
WW A 二位二通电磁阀 直动式 在断电位置关闭 	G 1/8	1.0	0.04	12	0.6	0~60	20046576 	a.A.	
	G 1/4	2.0	0.12	12	0.6	0~20	20046577 	a.A.	
		3.0	0.23	12	0.6	0~6	20046578 	a.A.	
		4.0	0.30	12	0.6	0~2	20046579 	a.A.	
		6.0	0.55	12	0.6	0~0.5	20046580 	a.A.	
	G 1/2	1.0	0.04	20	2	0~60	20046581 	20072644 	
		G 3/4	2.0	0.12	20	2	0~30	20046582 	20072648 
			3.0	0.23	20	2	0~10	20046583 	20072653 
			4.0	0.30	20	2	0~4	20046584 	20072657 
			6.0	0.55	20	2	0~1	20046585 	20072661 
WW B 二位二通电磁阀 直动式 在断电位置打开 	G 1/8	1.0	0.04	20	2	0~40	20046612 	20046630 	
	G 1/4	2.0	0.12	20	2	0~16	20046613 	20046631 	
		3.0	0.23	20	2	0~8	20046615 	20046632 	
		4.0	0.30	20	2	0~4	20046616 	20046633 	
		6.0	0.55	20	2	0~2	20046617 	20046634 	

a.A. = 可应要求提供







7.5. 6014 型订货表, 带 Kick and Drop 线圈

6014 型阀门是直动式二位三通电磁阀。Kick and Drop 线圈可将吸持功率降低至 10 瓦, 具体取决于版本。

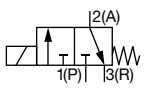

注意:

- 有关电磁阀的更多信息, 请参见 6014 型数据表 ▶。
- 其他版本带不锈钢阀体无短路环、其他电压、NPT 或 RC 内螺纹、法兰版本或其他密封材料, 可应要求提供。

回路功能	管道接口	通径 [mm]	K _v 值 (水) [m ³ /h]	线圈功率		压力范围 [bar]	订货号	
				吸合功率 [W]	吸持功率 [W]		24/AC/DC [V/Hz]	230~240/AC [V/Hz]
黄铜阀体, G 内螺纹, FKM/FKM 密封材料								
WW C 二位三通电磁阀 直动式 在断电位置关闭 	G 1/8	1.5	0.07	20	2	0~16	20046635 	20046663 
	G 1/4	2.0	0.11	20	2	0~10	20046636 	20046664 
		2.5	0.16	20	2	0~6	20046637 	20046665 
		3.0	0.2	20	2	0~4	20046638 	20046666 
WWD 二位三通电磁阀 直动式 在断电位置打开 	G 1/8	1.5	0.07	20	2	0~16	20046639 	20046667 
	G 1/4	2.0	0.11	20	2	0~10	20046640 	20046668 
		2.5	0.16	20	2	0~6	20046641 	20046669 
		3.0	0.2	20	2	0~4	20046642 	20046670 





7.6. 6026 型订货表, 带 Kick and Drop 线圈

6026 型阀门是直动式介质隔离的二位二通电磁阀。

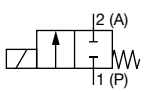

注意:

- 有关电磁阀的更多信息, 请参见 6026 型数据表 ▶。
- 其他版本带黄铜阀体无短路环、其他电压、NPT 或 RC 内螺纹、法兰版本或其他密封材料, 可应要求提供。

回路功能	管道接口	通径	K _v 值 (水)	线圈功率		压力范围	订货号	
		[mm]	[m ³ /h]	吸合功率 [W]	吸持功率 [W]		24 / AC/DC [V/Hz]	230~240/AC [V/Hz]
不锈钢阀体, G 内螺纹, PTFE 密封材料								
WW A 二位二通电磁阀 直动式 在断电位置关闭 	G ¼	4.0	0.5	44	6.5	0~10	20047000 	20047091 
		6.0	0.8	44	6.5	0~10	20047001 	20047098 

7.7. 6027 型订货表, 带 Kick and Drop 线圈

6027 型阀门是直动式二位二通电磁阀。Kick and Drop 线圈可将吸持功率降低至 14 瓦, 并增加常闭版本的压力范围。



注意:

- 有关电磁阀的更多信息, 请参见 6027 型数据表 ▶。
- 其他版本带不锈钢阀体、其他电压、NPT 或 RC 内螺纹、法兰版本或螺纹版本或其他密封材料, 可按要求提供。

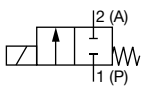
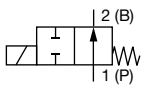
回路功能	管道接口	通径 [mm]	K _v 值 (水) [m ³ /h]	线圈功率		压力范围 [bar]	订货号	
				吸合功率 [W]	吸持功率 [W]		24/AC/DC [V/Hz]	230~240/AC [V/Hz]
黄铜阀体, G 内螺纹, FKM/FKM 密封材料 (对于 12.0 mm 的通径仅不锈钢阀体可用)								
WW A 二位二通电磁阀 直动式 在断电位置关闭 	G ¼	3.0	0.28	44	6.5	0~30	20047349 𠄎	20047359 𠄎
		4.0	0.54	44	6.5	0~30	20010689 𠄎	20047360 𠄎
	G ⅜	6.0	0.95	44	6.5	0~6	20047350 𠄎	20047361 𠄎
		8.0	1.6	44	6.5	0~3	20047351 𠄎	20047362 𠄎
		10.0	1.8	44	6.5	0~2	20033786 𠄎	20047363 𠄎
G ½	12.0	2.0	44	6.5	0~1.2	386731 𠄎	386737 𠄎	
WW B 二位二通电磁阀 直动式 在断电位置打开 	G ¼	3.0	0.28	44	6.5	0~13	20047353 𠄎	20047365 𠄎
		4.0	0.54	44	6.5	0~10	20047355 𠄎	20047369 𠄎
	G ⅜	6.0	0.95	44	6.5	0~6	20047356 𠄎	20047367 𠄎
		8.0	1.6	44	6.5	0~3	20047357 𠄎	20047369 𠄎
		10.0	1.8	44	6.5	0~2	374184 𠄎	20047370 𠄎
G ½	12.0	2.0	44	6.5	0~1	20047358 𠄎	20047371 𠄎	







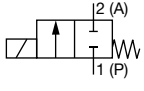

7.8. 6213 型订货表, 带 Kick and Drop 线圈

6213 型阀门是伺服辅助二位二通隔膜阀, 先导控制阀和隔膜采用弹簧连接。
Kick and Drop 线圈可将吸持功率降低至 14 瓦, 具体取决于版本。



注意:

- 有关电磁阀的更多信息, 请参见 6213 型数据表 ▶。
- 其他版本带不锈钢阀体无短路环、其他电压、NPT 或 RC 内螺纹、法兰版本或其他密封材料, 可应要求提供。

回路功能	管道接口	通径 [mm]	K _v 值 (水) [m ³ /h]	线圈功率		压力范围 [bar]	订货号	
				吸合功率 [W]	吸持功率 [W]		24 / AC/DC [V/Hz]	230~240/AC [V/Hz]
黄铜阀体, G 内螺纹, FKM/FKM 密封材料								
WW A 二位二通电磁阀 直动式 在断电位置关闭 	G 3/8	10.0	1.9	20	2	0~10	20047785 	20047788 
	G 1/2	13.0	3.6	20	2	0~10	20047786 	20047789 
							20047791 	20047793 
	G 3/4	20.0	8.3	20	2	0~10	20047787 	20047790 
							20047792 	20047794 
	G 1	25.0	11	85	8.5	0~10	20004797 	20048204 
	G 1 1/4	25.0	11	85	8.5	0~10	20048207 	20048205 
	G 1 1/2	40.0	30	85	8.5	0~10	20008169 	20048208 
G 2	40.0	30	85	8.5	0~10	20008170 	20048210 	

1.) 建议用于气体应用和真空应用

7.9. 6281 型订货表, 带 Kick and Drop 线圈

6281 型阀门是一款伺服辅助式二位二通隔膜阀。需要一个最小压力差才能工作。
Kick and Drop 线圈可将吸持功率降低至 7 瓦, 具体取决于版本。



注意:

- 有关电磁阀的更多信息, 请参见 6281 型数据表 ▶。
- 其他版本带不锈钢阀体无短路环、其他电压、NPT 或 RC 内螺纹、法兰版本或其他密封材料, 可应要求提供。

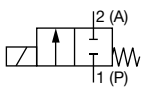
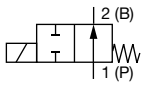
回路功能	管道接口	通径 [mm]	K _v 值 (水) [m ³ /h]	线圈功率		压力范围 [bar]	订货号	
				吸合功率 [W]	吸持功率 [W]		24 / AC/DC [V/Hz]	230~240/AC [V/Hz]
黄铜阀体, G 内螺纹, FKM/FKM 密封材料								
WW A 二位二通电磁阀 直动式 在断电位置关闭 	G ¼	10.0	1.5	12	0.6	0.2~16	20046906 𠄎	—
				20	2		a.A.	20046961 𠄎
	G ⅜	10.0	1.9	12	0.6	0.2~16	20046907 𠄎	—
				20	2		a.A.	20046962 𠄎
	G ½	13.0	3.8	12	0.6	0.2~16	20046908 𠄎	—
				20	2		a.A.	20046963 𠄎
	G ¾	20.0	8.5	12	0.6	0.2~16	20046909 𠄎	—
				20	2		a.A.	20046964 𠄎
	G 1	25.0	12	12	0.6	0.2~16	20046910 𠄎	—
				20	2		a.A.	20046965 𠄎
G 1¼	40.0	23	12	0.6	0.2~16	20046911 𠄎	—	
			20	2		a.A.	20046966 𠄎	
G 1½	40.0	30	12	0.6	0.2~16	20046912 𠄎	—	
			20	2		a.A.	20046967 𠄎	
G 2	50.0	40	12	0.6	0.2~16	20046913 𠄎	—	
			20	2		a.A.	20046968 𠄎	
G 2½	50.0	40	12	0.6	0.2~16	20046914 𠄎	—	
			20	2		a.A.	20046969 𠄎	
WW B 二位二通电磁阀 直动式 在断电位置打开 	G ¼	10.0	1.5	20	2	0.2~16	20046924 𠄎	20046970 𠄎
	G ⅜	10.0	1.9	20	2	0.2~16	20046925 𠄎	20046971 𠄎
	G ½	13.0	3.8	20	2	0.2~16	20046927 𠄎	20046972 𠄎
	G ¾	20.0	8.5	20	2	0.2~16	20046928 𠄎	20046973 𠄎
	G 1	25.0	12	20	2	0.2~16	20046929 𠄎	20046974 𠄎
	G 1¼	40.0	23	20	2	0.2~16	20046930 𠄎	20046975 𠄎
	G 1½	40.0	30	20	2	0.2~16	20046931 𠄎	20046976 𠄎
	G 2	50.0	40	20	2	0.2~16	20046932 𠄎	20046978 𠄎
G 2½	50.0	40	20	2	0.2~16	20046933 𠄎	20046979 𠄎	

a.A. = 可应要求提供

— = 不可用











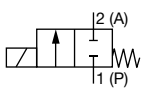

7.10.5404 型订货表, 带 Kick and Drop 线圈

5404 型阀门是一款伺服辅助式二位二通活塞阀。需要一个最小压力差才能工作。
Kick and Drop 线圈可将吸持功率降低至 9 瓦, 具体取决于版本。

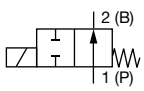

注意:

- 有关电磁阀的更多信息, 请参见 5404 型数据表 ▶。
- 其他版本无短路环、其他电压、NPT 或 RC 内螺纹、法兰版本或其他密封材料, 可应要求提供。

回路功能	管道接口	通径 [mm]	K _v 值 (水) [m ³ /h]	线圈功率		压力范围 [bar]	订货号	
				吸合功率 [W]	吸持功率 [W]		24/AC/DC [V/Hz]	230~240/AC [V/Hz]
黄铜阀体, G 内螺纹, PTFE/FKM 密封材料								
WW A 二位二通电磁阀 直动式 在断电位置关闭 	G 1/2	12.0	2	12	0.6	1~50	20047544 	—
				20	2		a.A.	20047551 
	G 3/4	20.0	7	12	0.6	1~25	20047545 	—
				20	2		a.A.	20047552 
	G 1	25.0	10	12	0.6	1~25	20047546 	—
				20	2		a.A.	20047554 
WW B 二位二通电磁阀 直动式 在断电位置打开 	G 1/2	12.0	2	20	2	1~32	20047547 	20047555 
	G 3/4	20.0	7	20	2	1~25	20047548 	20047559 
	G 1	25.0	10	20	2	1~25	20047550 	20047560 

a.A. = 可应要求提供
— = 不可用







7.11.6240 型订货表, 带 Kick and Drop 线圈

6240 型阀门是伺服辅助式二位二通活塞阀, 先导控制阀和活塞采用弹簧连接。
Kick and Drop 线圈可将吸持功率降低至 14 瓦, 并增加压力范围, 具体取决于版本。



注意:

- 有关电磁阀的更多信息, 请参见 6240 型数据表 ▶。
- 其他版本带黄铜阀体、其他电压、NPT 或 RC 内螺纹、法兰版本或插入式版本或其他密封材料, 可应要求提供。

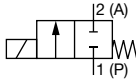
回路功能	管道接口	通径	K _v 值 (水)	线圈功率		压力范围	订货号	
				吸合功率	吸持功率		24 / AC/DC	230~240/AC
		[mm]	[m ³ /h]	[W]	[W]	[bar]	[V/Hz]	[V/Hz]
不锈钢阀体, G 内螺纹, FKM/FKM 密封材料								
WW A 二位二通电磁阀 直动式 在断电位置关闭	G ¼	6.0	0.6	20	2	0~25	20047418 	20047420 
	G ⅜	6.0	0.6	20	2	0~25	20047419 	20047421 
	G ½	12.0	2.2	44	6.5	0~25	20047422 	20047423 
								







7.12.6407 型订货表, 带 Kick and Drop 线圈

6407 型阀门是伺服辅助式二位二通活塞阀, 先导控制阀和活塞采用固定连接。
Kick and Drop 线圈可将吸持功率降低至 14 瓦。



注意:

- 有关电磁阀的更多信息, 请参见 6407 型数据表 ▶。
- 其他版本无短路环、其他电压、NPT 或 RC 内螺纹、法兰版本或其他密封材料, 可应要求提供。

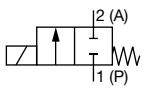
回路功能	管道接口	通径 [mm]	K _v 值 (水) [m ³ /h]	线圈功率		压力范围 [bar]	订货号	
				吸合功率 [W]	吸持功率 [W]		24 / AC/DC [V/Hz]	230~240/AC [V/Hz]
黄铜阀体, G 内螺纹, FKM/FKM 密封材料								
WW A 二位二通电磁阀 直动式 在断电位置关闭	G ½	13	3.7	44	6.5	0~10	20047532 	20047535 
	G ¾	20	5.6	44	6.5	0~10	20047533 	20047536 
	G 1	25	10.0	44	6.5	0~10	20047534 	20047537 
								

7.13. 配件订货表

2518 型设备插口, A 型插头, 符合 DIN EN 175301-803 标准

注意:

- 尺寸 mm
- 其他版本, 参见 2518 型数据表 ▶。

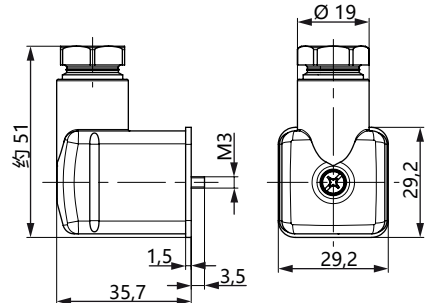
设备插口	尺寸	版本	电压	订货号
		无接线 (AC/DC)	0~250 V AC/DC	314802 𠄎
		带 LED (AC/DC)	12~24 V AC/DC	314812 𠄎
		带 LED 和压敏电阻 (AC/DC)	12~24 V AC/DC	314820 𠄎
		无接线 (AC/DC), 带硅胶密封件, 适用于较高的环境温度, 例如蒸汽版本 (NA07)	0~250 V AC/DC	361687 𠄎

2509 型设备插口, A 型插头, 符合 DIN EN 175301-803 标准

注意:

- 尺寸 mm
- 无接线 (标准)
- 与 Bürkert 电磁阀一起装配时, 2509 型设备插口符合 ATEX 类别3 GD 的要求。
- 与 Bürkert 电磁阀一起装配时, 2509 型设备插口符合 UL 认证 (UL 429) 的要求。
- 有关设备插口的更多信息, 请参见 2509 型数据表 ▶。

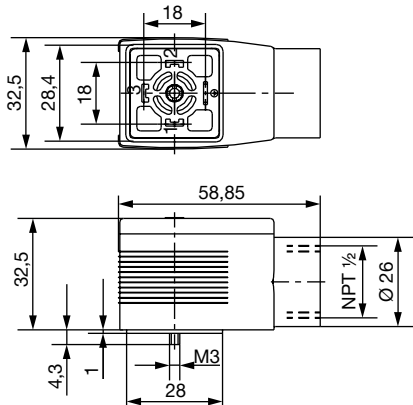
设备插口	尺寸	版本	电压	订货号
		无接线	0~250 V AC/DC	137943 𠄎

DTS 1000632946 ZH Version: A Status: RL (released | freigegeben | valide) printed: 14.04.2025