



Online Analysis System

- For analysis applications for drinking water and fresh water in industrial processes
- Modular sensor and electronic system:
 - up to 6 measurements in one housing
 - up to 30 analysis sensor cubes in one Bürkert system bus (bÜS)
- Prepared for fieldbus connectivity and remote access
- MEMS technologies allows minimal footprint and minimum sample water demand

Product variants described in the data sheet may differ from the product presentation and description.

Can be combined with

	Type MS01 pH Sensor Cube	▶
	Type MS02 Chlorine (Cl ₂) or chlorine dioxide (ClO ₂) Sensor Cube	▶
	Type MS03 Conductivity Sensor Cube	▶
	Type MS04 Redox Sensor Cube	▶
	Type MS05 Turbidity Sensor Cube	▶
	Type 8920 Bürkert Communicator	▶
	Type ME2X System Control Unit	▶
	Type MZ20 Cleaning System	▶

Type description

Type 8905 Online Analysis System is a compact and modular system for monitoring all important water parameters on one platform. It is a multichannel measuring system for the Bürkert sensor cubes as well as other electronic modules from the EDIP platform. The efficient device integration platform (EDIP) allows a high flexibility by using modularity in the hardware as well as in the software of the system.

The following parameters can be integrated into an online analysis system: pH, chlorine/chlorine dioxide, conductivity, ORP, turbidity, temperature.

A modular system concept allows the measuring system to be assembled according to customer requirements and enables simple installation and start-up, as well as operation and maintenance.

For maintenance, sensors can be removed without tools, while the remaining sensors continue to measure. The sensors are operated via an integrated 7" touch display or Bürkert Communicator. In addition to the display and storage of analysis parameters, other functions are possible, for example: programming of simple control algorithms using f(x), interventions in the process via analog and digital inputs and outputs, performing sensor calibrations.

Type 8905 is available as a compact system in one housing, as well as a customised system. For a system configuration please contact your Bürkert sales center.



Table of contents

1. General technical data	3
2. Materials	5
2.1. Chemical Resistance Chart – Bürkert resistApp.....	5
2.2. Material specifications	5
3. Dimensions	6
4. Product design and assembly	7
4.1. Product assembly	7
Housing for the electric modules	7
Housing for the sensor cubes.....	8
Mechanical interfaces of the sensor cubes	9
5. Product accessories	9
6. Ordering information	10
6.1. Bürkert eShop – Easy ordering and quick delivery	10
6.2. Recommendation regarding product selection.....	10
6.3. Bürkert product filter	10
6.4. Ordering chart.....	10
6.5. Ordering chart accessories.....	11

1. General technical data

Product properties

Material

Please make sure the device materials are compatible with the fluid you are using. Detailed information can be found in chapter [“2.1. Chemical Resistance Chart – Bürkert resistApp”](#) on page 5.

Detailed information on the materials can be found in chapter [“2.2. Material specifications”](#) on page 5.

Non wetted parts

Cover	<ul style="list-style-type: none"> • Of the electronic module housing: PC (glass fibre reinforced, UV stabilized, UL94 V0, anthracite grey), PC (black, UV stabilized, UL94 V0) and glass • Of the sensor cube housing: PC (glass fibre reinforced, UV stabilized, UL94 V0, anthracite grey) and PC (transparent)
Housing	PC (black, UV stabilized, UL94 V0)
Quarter-turn stud	Stainless steel
Cable entry plate	Elastomer
Wall-mounting bracket	Stainless steel
Self-adhesive spacer	Polyurethane

Wetted parts

Fluid connection	Biopolymer (EPDM seals)
Display	<ul style="list-style-type: none"> • 780 × 460 pixels resolution • Capacitive 7" Touchscreen, backlit
Dimensions	Detailed information can be found in chapter “3. Dimensions” on page 6.
Weight	<ul style="list-style-type: none"> • Approx. 8 kg (if equipped with 1 × 100...240 V AC power supply module + 1 × HMIU module + 5 sensor cubes) • Up to 12 kg (if totally equipped)
Data logger	Integrated Micro SD, 2 GB; adjustable logging interval; external reading via USB or LAN port

Electrical data

Operating voltage (“SUPPLY”)	<ul style="list-style-type: none"> • 100...240 V AC 50/60 Hz <ul style="list-style-type: none"> – current consumption at 100 V AC: 0.8 A – current consumption at 240 V AC: 0.3 A – tolerance: ± 10 % – integrated protective fuse: a slow blow 2 A fuse. The fuse cannot be replaced and is integrated in the power supply. or • 20...30 V DC <ul style="list-style-type: none"> – ± 10 % tolerance – filtered and regulated – connection to main supply: permanent (through external SELV and LPS power supply)
Power consumption	Max. 96 VA

Medium data

Fluid	Water without particles: drinking water, industrial water
Fluid pH range ¹⁾	pH 4...pH 9
Fluid conductivity	<ul style="list-style-type: none"> • >50 µS/cm if there is no pH sensor cube • >100 µS/cm if there is one pH sensor cube
Temperature of the fluid sample	+3...+40 °C (+37...+104 °F)
Pressure of the fluid sample	Refer to See data sheets of the sensor cubes and accessories, use the lowest pressure
Flow rate of the fluid sample	Min. flow rate: 6 l/h per installed sensor module, so with e.g. 3 sensor modules the min. flow rate is 6+6+6=18 l/h due to parallel installation.

Connection & communication

Sensor cube	<ul style="list-style-type: none"> • Max. 6 internal sensor cubes, max. 2 measurement water • Max. connection of 30 external sensor cubes via Bürkert-Systembus (büS) • Max. büS length 100 m (without T-connections)
Electrical connection	<ul style="list-style-type: none"> • Housing containing the electronic modules: 2 terminal blocks <ul style="list-style-type: none"> – male terminal block to connect the power supply to the system – female terminal block to feed the power supply to the sensor modules • Housing containing the sensor modules: 2 M12 connectors <ul style="list-style-type: none"> – male M12 connector to connect the power supply for the sensor modules – female M12 connector to connect the power supply to an external device.

Approvals and Certificates

Directives

CE directive	The applied standards, which verify conformity with the EU Directives, can be found on the EU Type Examination Certificate and/or the EU Declaration of conformity (if applicable)
--------------	--

Environment and installation

Installation	Wall mount unit, click system with wall-mounting bracket
Ambient temperature	<ul style="list-style-type: none"> • Operation: +3...+40 °C (+37...+104 °F) • Storage: -20...+70 °C (-4...+140 °F) (without sensor cube)
Relative air humidity	<95 %, without condensation
Height above sea level	Max. 2000 m
Operating condition	Continuous
Equipment mobility	Fixed
Application area	Indoor
Degree of protection according to IEC/EN 60529	IP65 with closed and tight housings
Installation category	<ul style="list-style-type: none"> • With an AC switched-mode power supply: category II, according to UL/EN 61010-1 • With a direct DC power supply: Category I, according to UL/EN 61010-1
Pollution degree	Degree 2, according to UL/EN 61010-1 with closed and tight housings

1.) When a chlorine sensor cube is present within the system: pH value is restricted to pH 5...pH 9

2. Materials

2.1. Chemical Resistance Chart – Bürkert resistApp

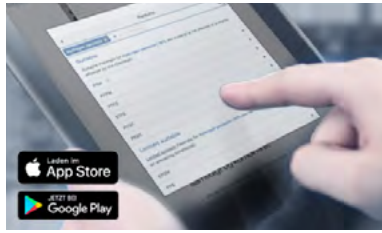

Bürkert resistApp – Chemical Resistance Chart

You want to ensure the reliability and durability of the materials in your individual application case? Verify your combination of media and materials on our website or in our resistApp.

[Start Chemical Resistance Check](#)

2.2. Material specifications

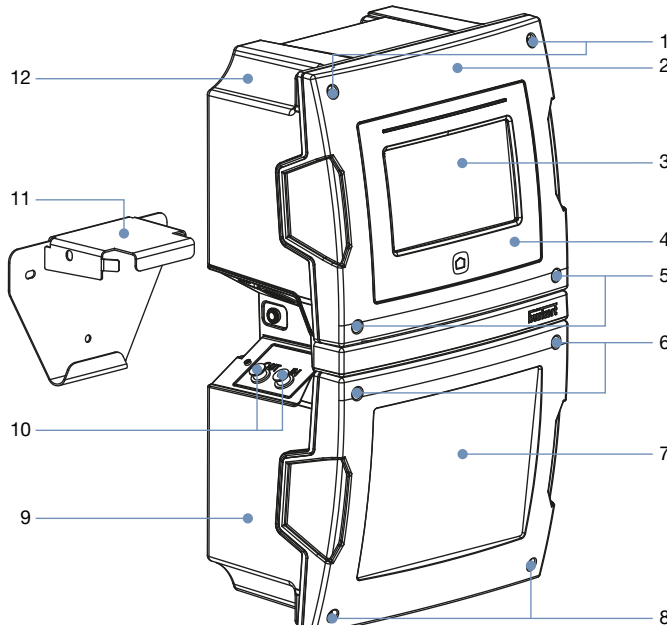

No.	Material
1	Stainless steel
2	PC, glass fibre reinforced, anthracite grey
3	Glass
4	PC, black
5	Stainless steel
6	Stainless steel
7	PC, transparent
8	Stainless steel
9	PC, black
10	Bio polymer, EPDM
11	Stainless steel
12	PC, black

3. Dimensions

Note:

Dimensions in mm, unless otherwise stated

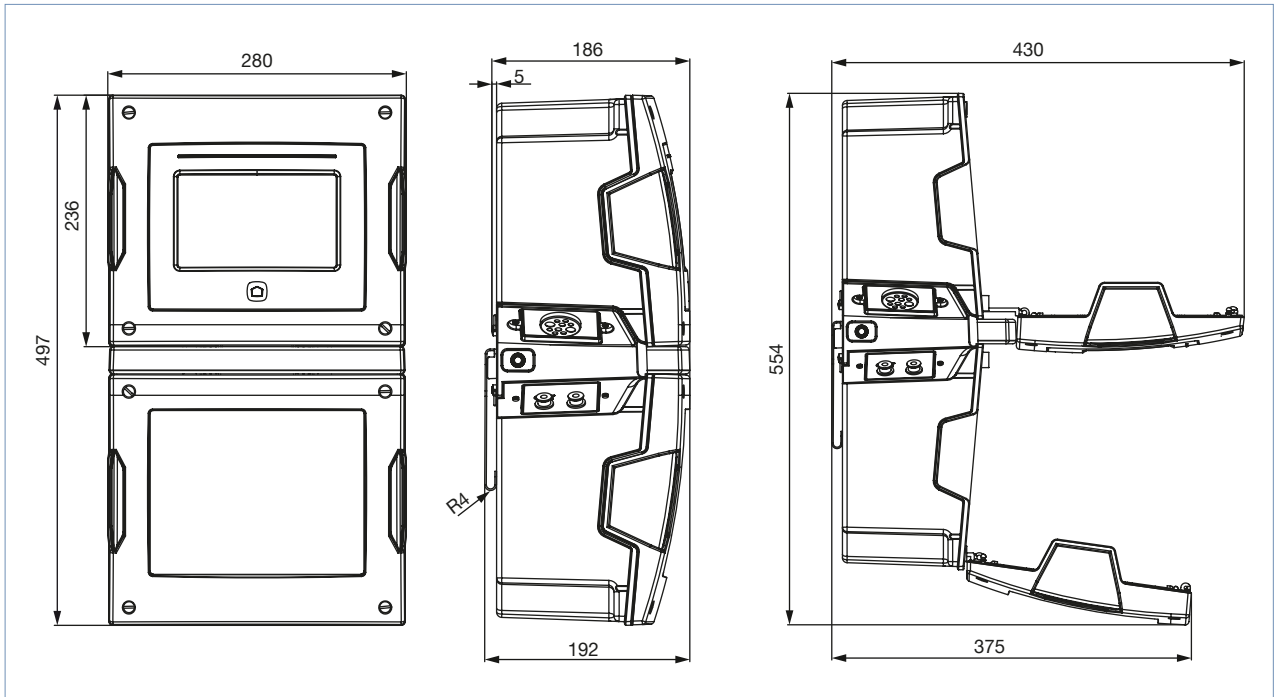

4. Product design and assembly

4.1. Product assembly

Housing for the electric modules

The device is always equipped with the following electronic modules:

- HMIU (Human Machine Interface Unit) incl. USB slot and Ethernet connection
- 7" touchscreen incl. USB slot
- Option: PSU mains supply 100...240 V AC
- 2x bÜS connector

A total of 7 slots (5 for 230 V/115 V AC variant) are available for electronic modules:

- Digital and analogue inputs and outputs
- Fieldbus gateway

The main housing parts for the electric modules are shown in the following drawing.

Depending on the configuration of the device and for a complete description and for the technical data related to the electronic modules, refer to the data sheets of each electronic modules.

See **data sheet Type ME2X** ▶ for more information.

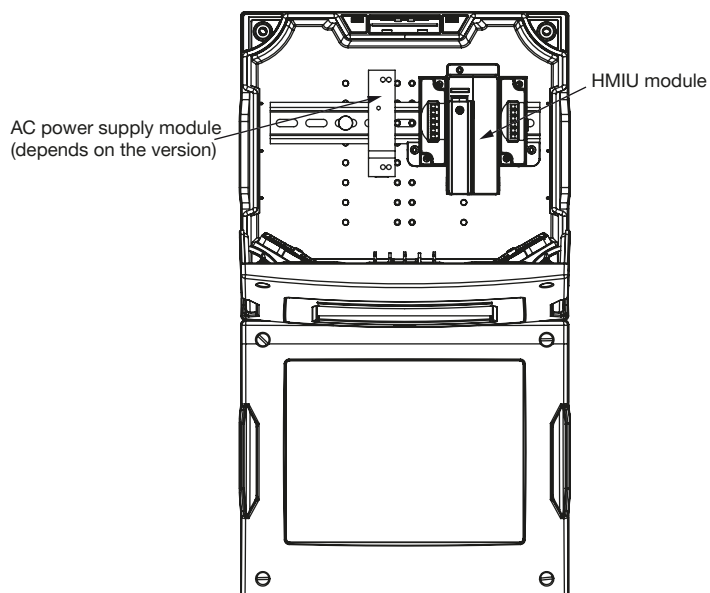

Housing for the sensor cubes

The device can contain one to six sensor cubes. The main housing parts for the sensor cubes are shown in the following drawing. Depending on the configuration of the device and for a complete description and for the technical data related to the sensor cubes, refer to the data sheets of each sensor cubes (see following table).

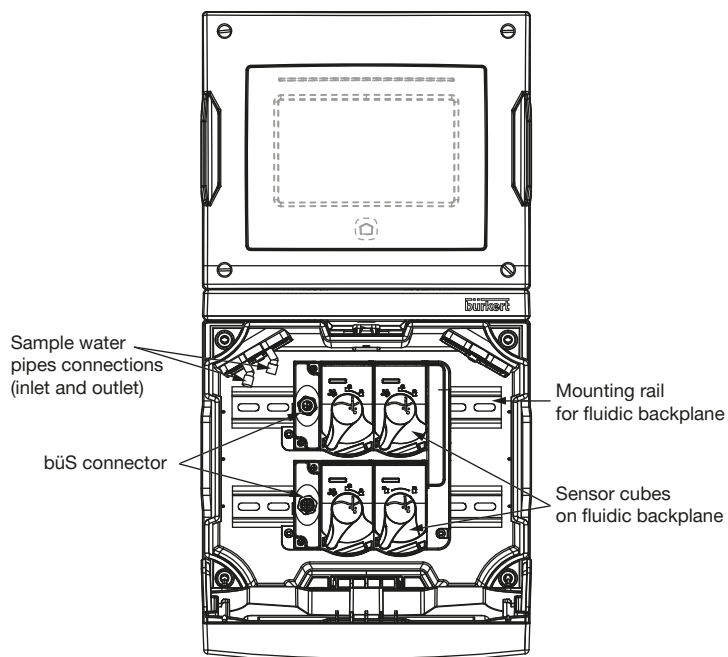

Sensor cubes	Measured physical value	Marking of the push buttons
pH sensor cube, see data sheet Type MS01 ▶	pH and temperature	
Chlorine sensor cube, see data sheet Type MS02 ▶	Chlorine, chlorine dioxide and temperature	
Conductivity sensor cube, see data sheet Type MS03 ▶	Conductivity and temperature	
ORP sensor cube, see data sheet Type MS04 ▶	Redox potential	
Turbidity sensor cube, see data sheet Type MS05 ▶	Turbidity (ISO and EPA)	

Mechanical interfaces of the sensor cubes

All the fluidic backplanes for the sensor cubes have the same design. Thus any sensor cube can be plugged on any mechanical interface.

The backplanes are connected to each other and feed the sensor cubes parallel with the power supply, the sample water and serial bÜS connection.

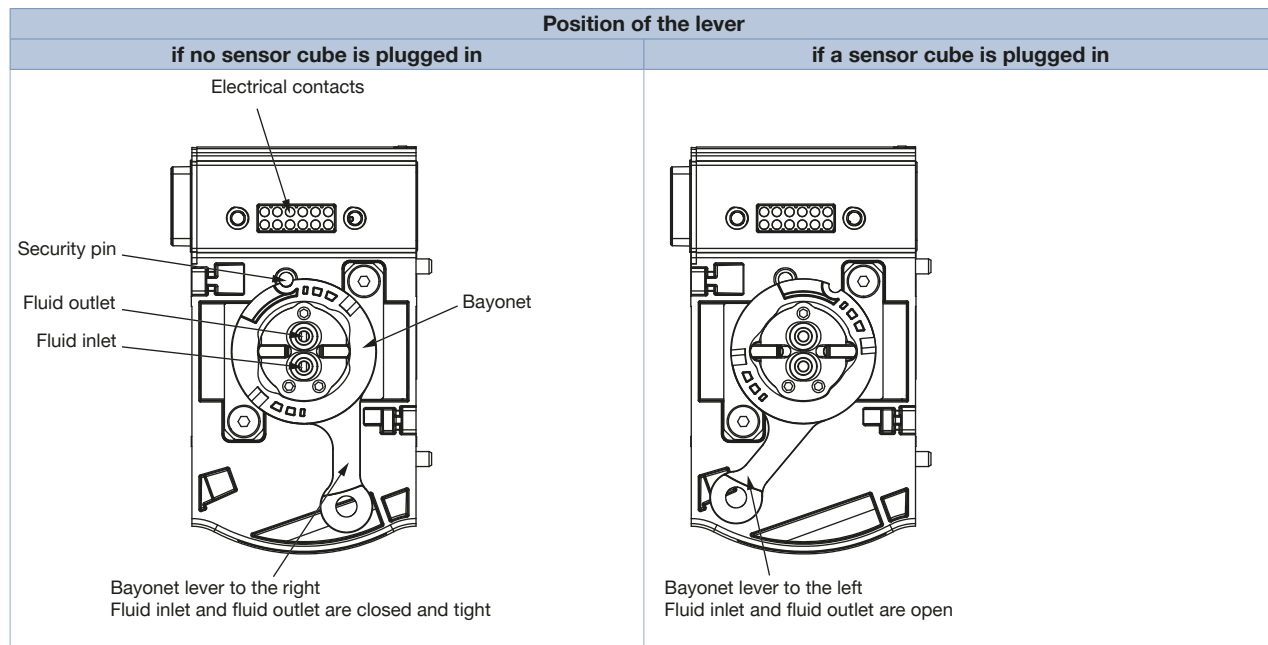

5. Product accessories

Note:

To set up a device without a display, use the USB-bÜS interface, Type 8923 and the Bürkert Communicator Type 8920.

See **Software manual Type 8920** ▶ for more information.

Accessories	No.	Description
	1	Quick-Start
	2	Power supply: 100...240 V AC/ 24 V DC 1 A and adaptors for power supply worldwide use
	3	bÜS terminating resistor on bÜS Y-splitter
	4	5-pin M12 circular male connector wired on free end cable
	5	bÜS connection cable with 5-pin M12 circular male connector, micro USB B plug
	6	bÜS adapter with 5-pin M12 circular male connector, A-coded to 5-pin M12 circular male connector, A-coded
	7	bÜS stick (USB to bÜS/CANopen adaptor)
	8	bÜS service cable with 5-pin M12 circular female connector, mini USB and circular plug-in connectors for power supply
	9	Magnetic key
	10	CD - Communicator (30-day license without registration, update and licensing over Bürkert home page)

DTS 1000220829 EN Version: L Status: RL (released | freigegeben | valide) printed: 09.01.2025

6. Ordering information

6.1. Bürkert eShop – Easy ordering and quick delivery



Bürkert eShop – Easy ordering and quick delivery

You want to find your desired Bürkert product or spare part quickly and order directly? Our online shop is available for you 24/7. Sign up and enjoy all the benefits.

[Order online now](#)

6.2. Recommendation regarding product selection

The Online Analysis System Type 8905 is a compact and modular system in a single housing, offering a wide range of configuration possibilities.

Thank you for your interest in our products! In order to provide you with the best possible advice, please contact your local Bürkert branch office for customised system design.

6.3. Bürkert product filter



Bürkert product filter – Get quickly to the right product

You want to select products comfortably based on your technical requirements? Use the Bürkert product filter and find suitable articles for your application quickly and easily.

[Try out our product filter](#)































6.4. Ordering chart

Note :

This table shows exemplary configurations of the online analysis system.

Description	Operating voltage	Equipment						Article no.
		MS01 sensor cube pH	MS02 sensor cube Chlorine	MS03 sensor cube Conductivity	MS04 sensor cube ORP	MS05 sensor cube Turbidity	PSU: incl. 100...240 V AC power supply	
Online Analysis System – pH, Conductivity, Turbidity	24 V DC	1	–	1	–	1	–	On request
	100...240 V AC	1	–	1	–	1	1	
Online Analysis System – pH, Chlorine, Turbidity	24 V DC	1	1	–	–	1	–	
	100...240 V AC	1	1	–	–	1	1	
Online Analysis System – pH, ORP, Conductivity, Turbidity	24 V DC	1	–	1	1	1	–	
	100...240 V AC	1	–	1	1	1	1	
Online Analysis System – pH, Chlorine, ORP, Turbidity	24 V DC	1	1	–	1	1	–	
	100...240 V AC	1	1	–	1	1	1	
Online Analysis System – pH, Chlorine, Conductivity, ORP, Turbidity	24 V DC	1	1	1	1	1	–	
	100...240 V AC	1	1	1	1	1	1	

6.5. Ordering chart accessories

Description		Article no.	
Set including the wall-mounting bracket with four self-adhesive bumpers		566363 	
Sample water pipe 4/6 mm	5 m	567793 	
	10 m	567701 	
	25 m	567794 	
Strainer 100 µm		772703 	
Pressure reducer		772437 	
Bubble trap		568492 	
Set with a pressure reducer (including a 100 µm strainer, a sampling point and two G ¼" connections), a wall-mounting bracket with nut (for the pressure reducer), a pressure gauge (for the pressure reducer) and two quick-connect couplings		566319 	
Filter housing made of plastic with NBR seal for filter element 50 µm, inlet and outlet ¼"		774292 	
Filter housing made of plastic with NBR seal for filter element 90 µm or 140 µm, inlet and outlet ¼"		774287 	
Filter element	50 µm	774293 	
	90 µm	774290 	
	140 µm	774291 	
Type MZ20 cleaning system, 2 solutions See data sheet Type MZ20  Cleaning System for more information.		567124 	
Interface accessories			
büS Stick Set			
	USB-büS-Interface Set 1, Type 8923 Detailed information can be found in chapter "5. Product accessories" on page 9.	772426 	
USB-büS Interface Set 2, Type 8923 (only büS Stick, cable and büS service cable)		772551 	
Connectors and sockets			
büS Y-distributor, 5-pin M12 circular female connector to 5-pin M12 circular male and 5-pin M12 circular connectors		772420 	
büS Y-distributor, 5-pin M12 circular female connector to 5-pin M12 circular male and 5-pin M12 circular connectors (power interrupt)		772421 	
büS adaptor M12 circular male connector A-coded - M12 circular male connector A-coded		772867 	
büS termination, 5-pin M12 circular male connector		772424 	
büS termination, 5-pin M12 circular female connector		772425 	
Extensions			
	5-pin M12 straight circular female and male connectors moulded on büS cable, shielded	0.5 m	772403 
		1 m	772404 
		3 m	772405 
		5 m	772406 
		10 m	772407 
		20 m	772408 
Software			
Software Bürkert Communicator		Download Type 8920 	

Bürkert – Close to You

For up-to-date addresses
please visit us at
www.burkert.com

DTS 1000220829 EN Version: L Status: RL (released | freigegeben | validé) printed: 09.01.2025

Austria
Belgium
Czech Republic
Denmark
Finland
France
Germany
Italy
Netherlands

Norway
Poland
Spain
Sweden
Switzerland
Turkey
United Kingdom

Canada
USA

Brazil
Uruguay

South Africa

United
Arab
Emirates

Australia
New Zealand

China
Hong Kong
India
Japan
Korea
Malaysia
Philippines
Singapore
Taiwan