



Ball valve / Butterfly valve with pneumatic rotary actuator

- Pneumatic rotary actuator
- Accurate end position setting
- High flow values
- High medium pressures
- Long service life

Product variants described in the data sheet may differ from the product presentation and description.

Can be combined with

	Type 6519 Servo-assisted 3/2, 5/2 or 5/3-way solenoid valve for pneumatics	▶
	Type 1061 Position feedback unit for pneumatic rotary actuators	▶
	Type 8791 Digital electropneumatic positioner SideCONTROL	▶
	Type 8792 Digital electropneumatic positioner SideCONTROL	▶
	Type 8793 Digital electropneumatic Process Controller SideCONTROL	▶
	Type 8691 Control head for decentralised automation of ELEMENT process valves	▶
	Type 8692 Digital electropneumatic positioner for integrated mounting on process control valves	▶
	Type 8694 Digital electropneumatic positioner for integrated mounting on process control valves	▶

Type description

Type 8805 consists of a quarter-turn valve (ball or butterfly valve) and a pneumatic rotary actuator. The rotary actuator is available as single or double-acting actuator. Type 8805 can be complemented by a positioner (Type 8791, 8792, 8793, 8691, 8692, 8693, 8694), a pilot valve (Type 6519) or several kinds of position feedbacks (Type 1061).

Table of contents

1. General technical data	3
1.1. 2/2-way ball valve, stainless steel body.....	3
1.2. 3/2-way ball valve, stainless steel body.....	4
2. Approvals and conformities	4
2.1. General notes.....	4
2.2. Conformity.....	4
2.3. Standards.....	4
3. Circuit functions	4
4. Materials	5
4.1. Bürkert resistApp.....	5
5. Dimensions	6
5.1. 2/2-way ball valve, stainless steel body.....	6
5.2. 2/2-way ball valve, compact flange ball valve.....	7
5.3. 2/2-way ball valve, stainless steel body, 3 pieces, threaded connection.....	8
5.4. 2/2-way ball valve, stainless steel body, 3 pieces, welded connection.....	9
5.5. 3/2-way ball valve, stainless steel body.....	10
6. Performance specifications	11
6.1. Pressure temperature diagram.....	11
6.2. Switching position of the 3/2-way ball valves.....	11
6.3. Opening and closing times.....	11
7. Ordering information	11
7.1. Bürkert eShop.....	11
7.2. Bürkert product filter.....	12
7.3. Ordering chart 2/2-way ball valve.....	12
7.4. Ordering chart 2/2-way compact flange ball valve.....	13
7.5. Ordering chart 3/2-way ball valve.....	13
7.6. Ordering chart accessories.....	14
Position feedback Type 1061.....	14
Positioner Type 8792.....	14
Positioner mounting kit Type 8792/8793.....	14
Type 6519 NAMUR.....	15
Cable plug Type 2518, Form A according to DIN EN 175301..803.....	15
Reducing sleeves.....	15

1. General technical data

Product properties	
Dimensions	Further information can be found in chapter "5. Dimensions" on page 6.
Material	
Seal	Ball seal: PTFE, stem seal: FKM
Body	Stainless steel 1.4408/316
Actuator	Aluminium
Ball	Stainless steel 1.4401/316
Stem	Stainless steel 1.4401/316
Performance data	
Pressure range	Further information can be found in chapter "7. Ordering information" on page 11.
Pilot pressure	Max. 6...8 bar ¹⁾
Nominal diameter	2/2-way ball valve: DN 10...100 3/2-way ball valve: DN 10...40
Medium data	
Medium temperature	Depending on the ball valve and the medium pressure, see "6.1. Pressure temperature diagram" on page 11
Control medium	Filtered oil-free or lubricated compressed dry air
Process/Port connection and communication	
Port connection	2/2-way ball valve: Rp ¼"...Rp 4" Whitworth thread according to DIN EN 10226 - 1 (old DIN 2999), welded connection, flange 3/2-way ball valve: Rp ¼"...Rp 2" Whitworth thread according to DIN EN 10226 - 1 (old DIN 2999)
Environment and installation	
Installation position	Do not install the actuator upside down, maximum installation angle: 90°
Ambient temperature	- 10 °C...+ 80 °C, see "6.1. Pressure temperature diagram" on page 11

1.) Pressure values: overpressure to atmospheric pressure. Design of units for smaller pilot pressures on request.

1.1. 2/2-way ball valve, stainless steel body

Note:

For more information about the control function see "3. Circuit functions" on page 4.

Nominal diameter	Control function ¹⁾	K _v value 2-/3-pieces/compact flange ball valve [m ³ /h]	Nominal pressure ²⁾			Weight		
			2 pieces [bar]	3 pieces [bar]	Compact flange ball valve [bar]	2 pieces [kg]	3 pieces [kg]	Compact flange ball valve [kg]
10 / 12	A, B	9/13	100	63	–	1.5	1.85	–
	I	9/13	100	63	–	1.4	1.75	–
15	A, B	19	100	63	–	2.2	2.45	–
	I	19	100	63	–	1.5	1.75	–
20	A, B	46	100	63	40	4.0	2.7	3.8
	I	46	100	63	40	2.4	1.95	2.1
25	A, B	72	100	63	40	4.3	4.6	6
	I	72	100	63	40	2.6	2.3	4.4
32	A, B	105	100	63	40	5.9	5.25	7.7
	I	105	100	63	40	4.2	3.6	6.2
40	A, B	170	100	63	40	7.6	7.4	9.8
	I	170	100	63	40	5.9	4.6	8.1
50	A, B	275	100	63	40	13.4	9.1	12.8
	I	275	100	63	40	7.4	7.4	9
65	A, B	507	100	63	16	–	16	20
	I	507	100	63	16	–	13.2	14
80	A, B	905	100	63	16	–	25.1	26.3
	I	905	100	63	16	–	19.6	17.3
100	A, B	1414	100	63	16	–	35.2	29
	I	1414	100	63	16	–	28	21.8

1.) Control functions A, B are single-acting, I is double-acting.

2.) Operating pressure: see "6.1. Pressure temperature diagram" on page 11

1.2. 3/2-way ball valve, stainless steel body

Nominal diameter	Port connection [inch]	K _v value [m ³ /h]	Nominal pressure ¹⁾ [bar]	Weight	
				CF A [kg]	CF I [kg]
10/12	1/4 / 3/8	4.7 / 6.9 ¹⁾	63	2.55	–
				–	1.85
12	1/2	6.9 / 11.2 ¹⁾	63	2.7	–
				–	2
15	3/4	6.9 / 11.2 ¹⁾	63	4.3	–
				–	2.2
20	1	18.9 / 29.2 ¹⁾	63	4.9	–
				–	3.4
25	1 1/4	35.3 / 46.4	63	7.3	–
				–	5.75
32	1 1/2	46.4 / 72.2 ¹⁾	63	8.3	–
				–	6.7
40	2	83.4 / 135.9 ¹⁾	63	13.9	–
				–	11.5

1) Depending on the switch position

2. Approvals and conformities

2.1. General notes

- The approvals and conformities listed below must be stated when making enquiries. This is the only way to ensure that the product complies with all required specifications.
- Not all available variants can be supplied with the below mentioned approvals or conformities.

2.2. Conformity

In accordance with the Declaration of Conformity, the product is compliant with the EU Directives.

2.3. Standards

The applied standards which are used to demonstrate compliance with the EU Directives are listed in the EU-Type Examination Certificate and/or the EU Declaration of Conformity.

3. Circuit functions

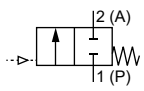
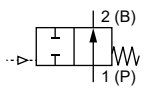
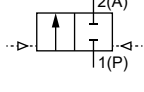
Control function	Description
	Control function A (CF A) Pneumatically operated 2/2-way on/off valve Flow direction above seat Normally closed by spring force
	Control function B (CF B) Single-acting actuator for pneumatically operated 2/2-way on/off valve Normally opened by spring force
	Control function I (CF I) Pneumatically operated 2/2-way on/off valve on either side Flow direction above seat Switching position dependent on external control

4. Materials

4.1. Bürkert resistApp



Bürkert resistApp – Chemical resistance chart

You want to ensure the reliability and durability of the materials in your individual application case? Verify your combination of media and materials on our website or in our resistApp.

[Start chemical resistance check](#)

5. Dimensions

5.1. 2/2-way ball valve, stainless steel body

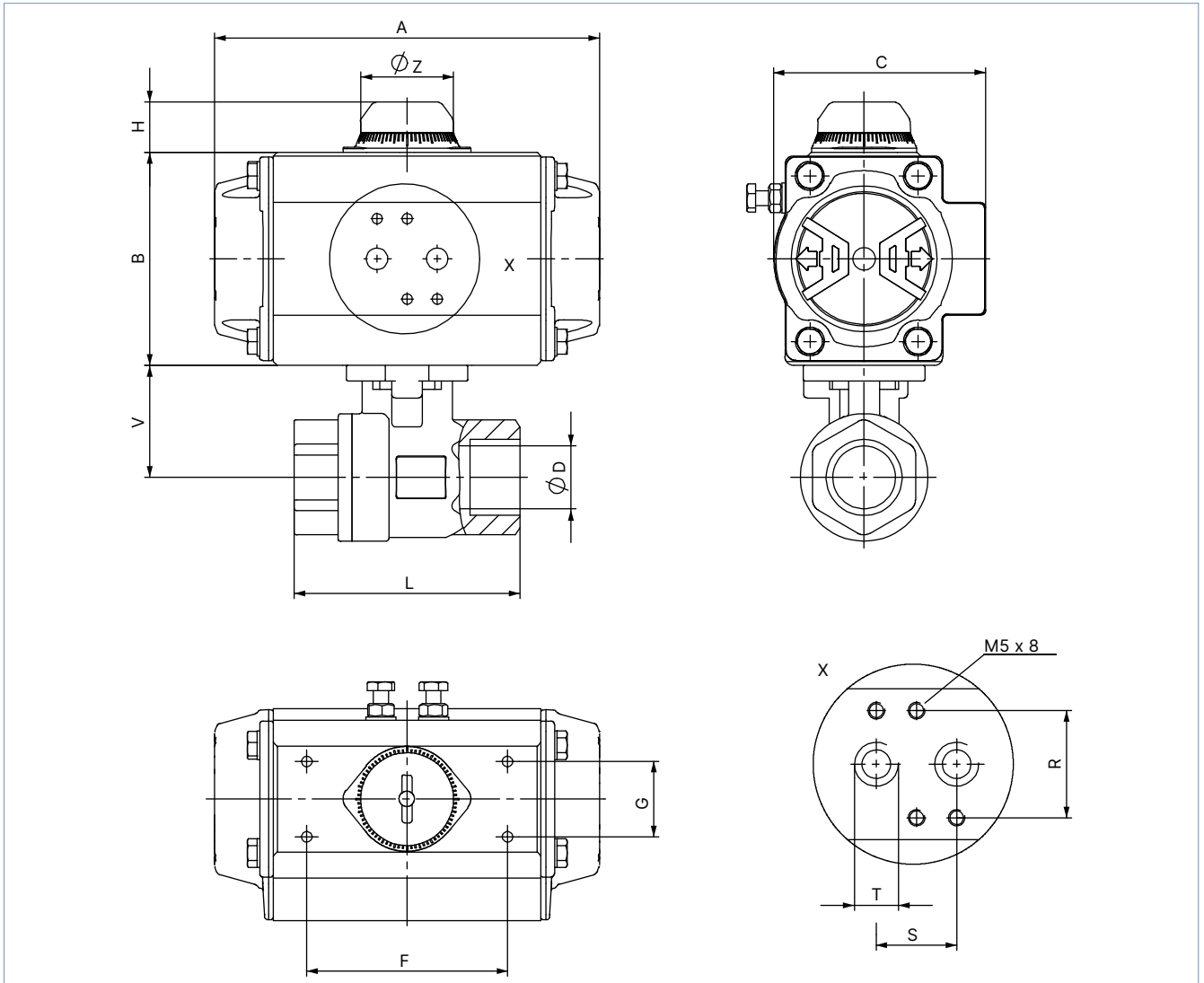

Nominal diameter	Port connection [inch]	Actuator	Actuator dimensions										Valve dimensions		
			A [mm]	B [mm]	C [mm]	F [mm]	G [mm]	H [mm]	R [mm]	S [mm]	T [inch]	Ø Z [mm]	L [mm]	Ø D [mm]	V [mm]
10	¼	15	136	69	72	80	30	20	32	24	⅛	37	50	11.6	33.2
12	⅜	15	136	69	72	80	30	20	32	24	⅛	37	60	12.7	33.2
15	½	15	136	69	72	80	30	20	32	24	⅛	37	75	15	35
		30	153.5	85	84.5	80	30	20	32	24	⅛	37			
20	¾	30	153.5	85	84.5	80	30	20	32	24	⅛	37	80	20	41
		60	203.5	102	93	80	30	20	32	24	⅛	37			
25	1	30	153.5	85	84.5	80	30	20	32	24	⅛	37	90	25	44.5
		60	203.5	102	93	80	30	20	32	24	⅛	37			
		100	241	115	106	80	30	20	32	24	⅛	37			
32	1¼	60	203.5	102	93	80	30	20	32	24	⅛	37	110	31.8	49.5
		100	241	115	106	80	30	20	32	24	⅛	37			
40	1½	100	241	115	106	80	30	20	32	24	⅛	37	120	38	55
		150	259	127	118.5	80	30	20	32	24	¼	37			
50	2	100	241	115	106	80	30	20	32	24	⅛	37	140	50.8	66.5
		220	304	145	136	80	30	20	32	24	¼	37			

DTS 1000109493 EN Version: T Status: RL (released | freigegeben | valide) printed: 10.04.2025

5.2. 2/2-way ball valve, compact flange ball valve

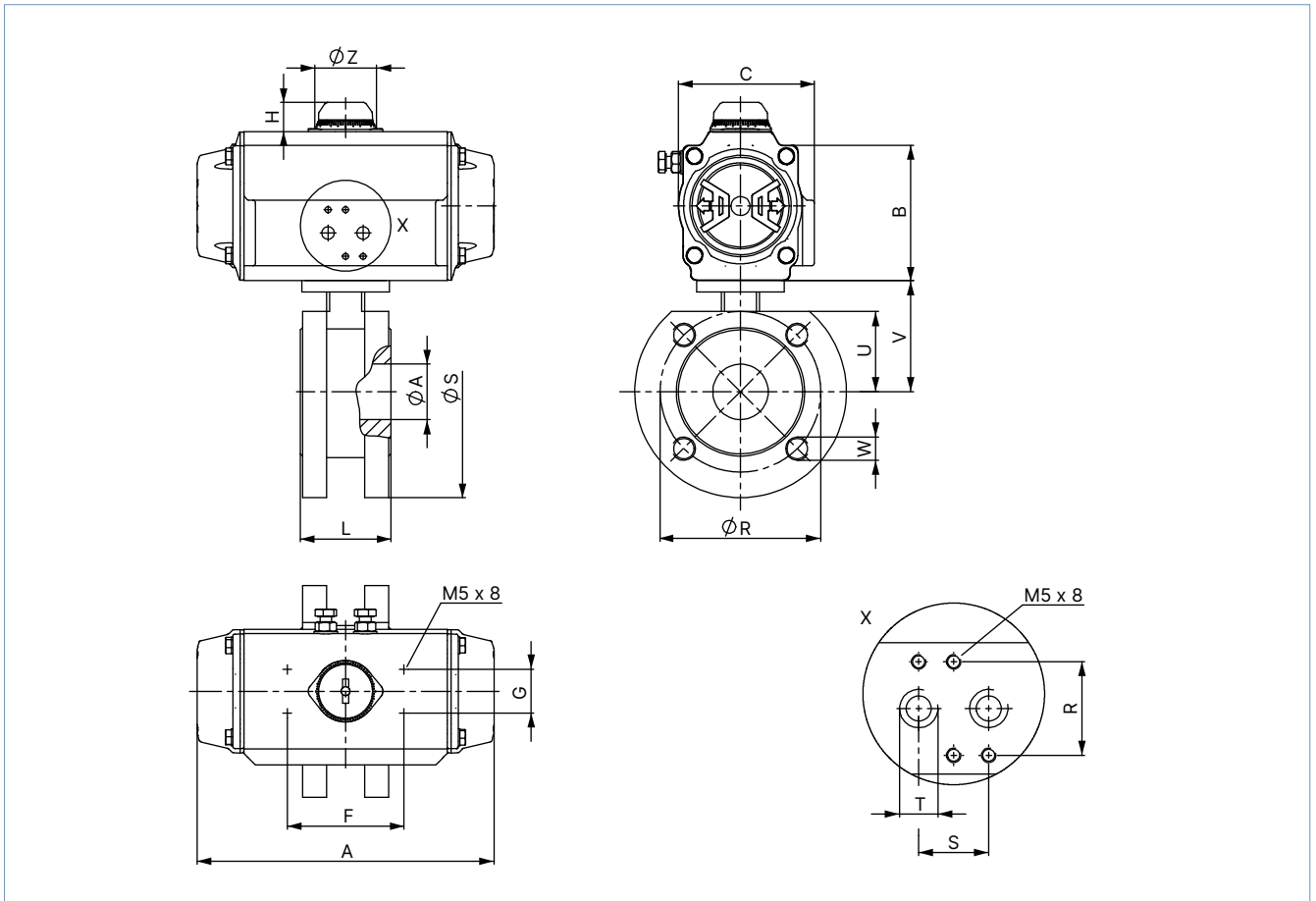

Nominal diameter	Actuator	Actuator dimensions										Valve dimensions						Flange pattern
		A	B	C	F	G	H	R	S	T	ØZ	L	ØR	ØS	ØA	U	V	
		[mm]	[mm]	[mm]	[mm]	[mm]	[mm]	[mm]	[mm]	[inch]	[mm]	[mm]	[mm]	[mm]	[mm]	[mm]	[mm]	
20	15	140.5	69	59	80	30	20	32	24	1/8	42	44	75	105	20	38.5	64.3	M12 × 1.75
	30	158.5	85	72	80	30	20	32	24	1/8	42							
25	30	158.5	85	72	80	30	20	32	24	1/8	42	53	85	115	25	44.6	64.6	M12 × 1.75
	60	210.5	102	84.5	80	30	20	32	24	1/8	42							
32	30	158.5	85	72	80	30	20	32	24	1/8	42	58.4	100	135	32	51	70	M16 × 2
	60	210.5	102	84.5	80	30	20	32	24	1/8	42							
40	60	210.5	102	84.5	80	30	20	32	24	1/8	42	62	110	145	38	55	76.3	M16 × 2
	100	247.5	115	97.5	80	30	20	32	24	1/8	42							
50	60	210.5	102	84.5	80	30	20	32	24	1/8	42	78	125	155	50	63	85.7	M16 × 2
	150	268.5	127	111	80	30	20	32	24	1/4	42							
65	100	247.5	115	97.5	80	30	20	32	24	1/8	42	100	145	185	65	73.5	105	M16 × 2 (8 bores)
	220	315	145	127	80	30	30	32	24	1/4	58							
80	100	247.5	115	97.5	80	30	20	32	24	1/8	42	120	160	200	76	94	123	M16 × 2 (8 bores)
	300	345	157	136	80	30	30	32	24	1/4	42							
100	150	268.5	127	111	80	30	20	32	24	1/4	42	152	180	220	96	105	132	M16 × 2 (8 bores)
	300	345	157	136	80	30	30	32	24	1/4	58							

DTS 1000109493 EN Version: T Status: RL (released | freigegeben | valide) printed: 10.04.2025

5.3. 2/2-way ball valve, stainless steel body, 3 pieces, threaded connection

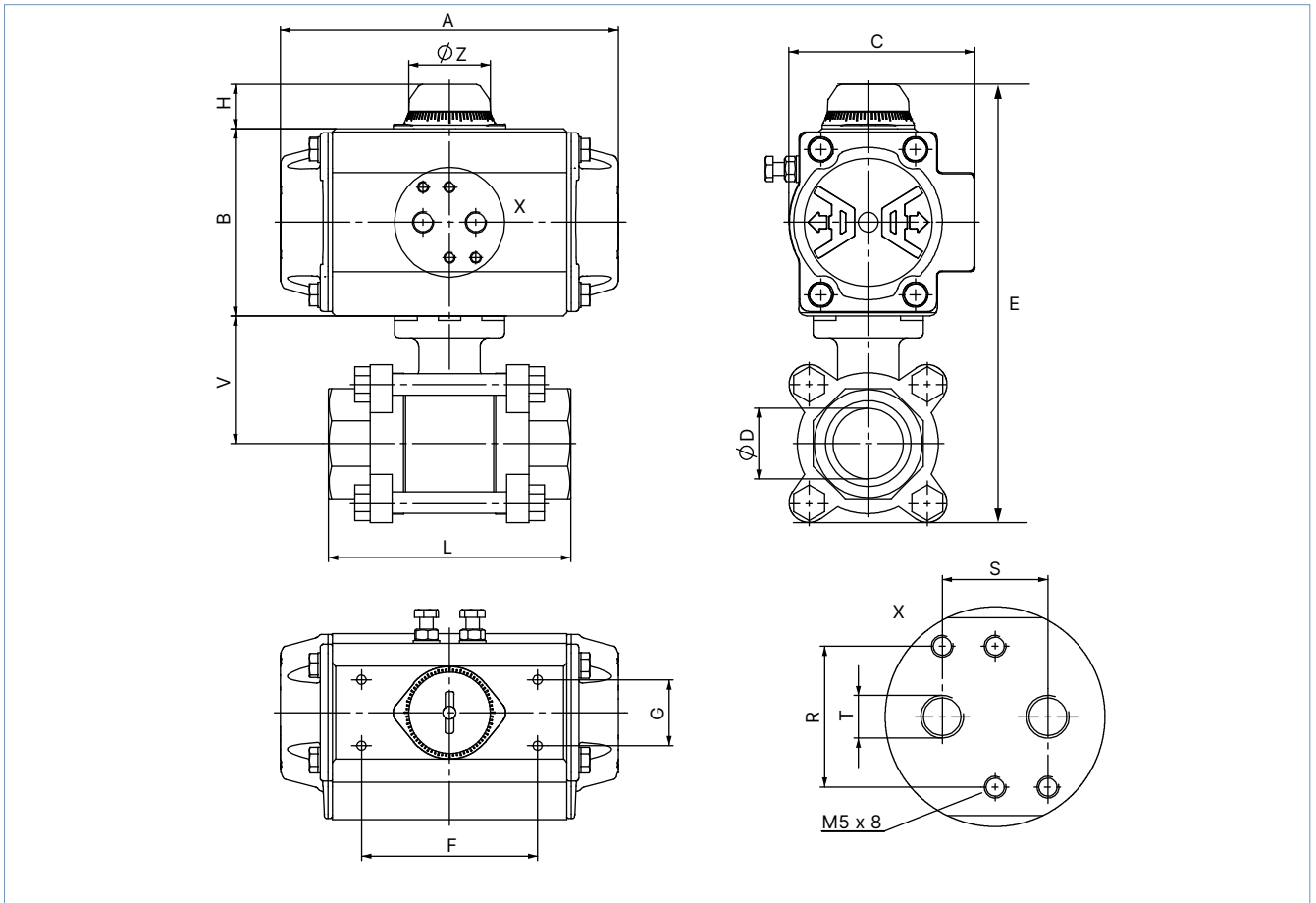

Nominal diameter	Port connection [inch]	Actuator	Actuator dimensions											Valve dimensions			
			A	B	C	E	F	G	H	R	S	T	Ø Z	L	Ø D	V	
			[mm]	[mm]	[mm]	[mm]	[mm]	[mm]	[mm]	[mm]	[mm]	[mm]	[mm]	[mm]	[mm]	[mm]	[mm]
10	¼	15	136	69	72	155	80	30	20	32	24	⅛	37	65	10	40	
12	⅜	15	136	69	72	155	80	30	20	32	24	⅛	37	65	12	40	
15	½	15	136	69	72	171	80	30	20	32	24	⅛	37	75	15	40	
		30	153.5	85	84.5		80	30	20	32	24	⅛	37				
20	¾	15	136	69	72	177	80	30	20	32	24	⅛	37	80	20	44	
		30	153.5	85	84.5		80	30	20	32	24	⅛	37				
25	1	15	136	69	72	206	80	30	20	32	24	⅛	37	90	25	52	
		60	203.5	102	93		80	30	20	32	24	⅛	37				
32	1¼	30	153.5	85	84.5	217.5	80	30	20	32	24	⅛	37	110	32	58	
		60	203.5	102	93		80	30	20	32	24	⅛	37				
40	1½	30	153.5	85	84.5	245	80	30	20	32	24	⅛	37	120	40	68	
		100	241	115	106		80	30	20	32	24	⅛	37				
50	2	60	203.5	102	93	262.5	80	30	20	32	24	⅛	37	140	50	77	
		100	241	115	106		80	30	20	32	24	⅛	37				
65	2½	100	241	115	106	309	80	30	20	32	24	⅛	37	185	65	98	
		150	259	127	118.5		80	30	20	32	24	¼	37				
80	3	150	259	127	118.5	370.5	80	30	20	32	24	¼	37	205	80	110	
		220	304	145	136		80	30	30	32	24	¼	51				
100	4	150	259	127	118.5	422	80	30	20	32	24	¼	37	240	100	138	
		300	333	157	146.5		80	30	30	32	24	¼	51				

DTS 1000109493 EN Version: T Status: RL (released | freigegeben | valide) printed: 10.04.2025

5.4. 2/2-way ball valve, stainless steel body, 3 pieces, welded connection

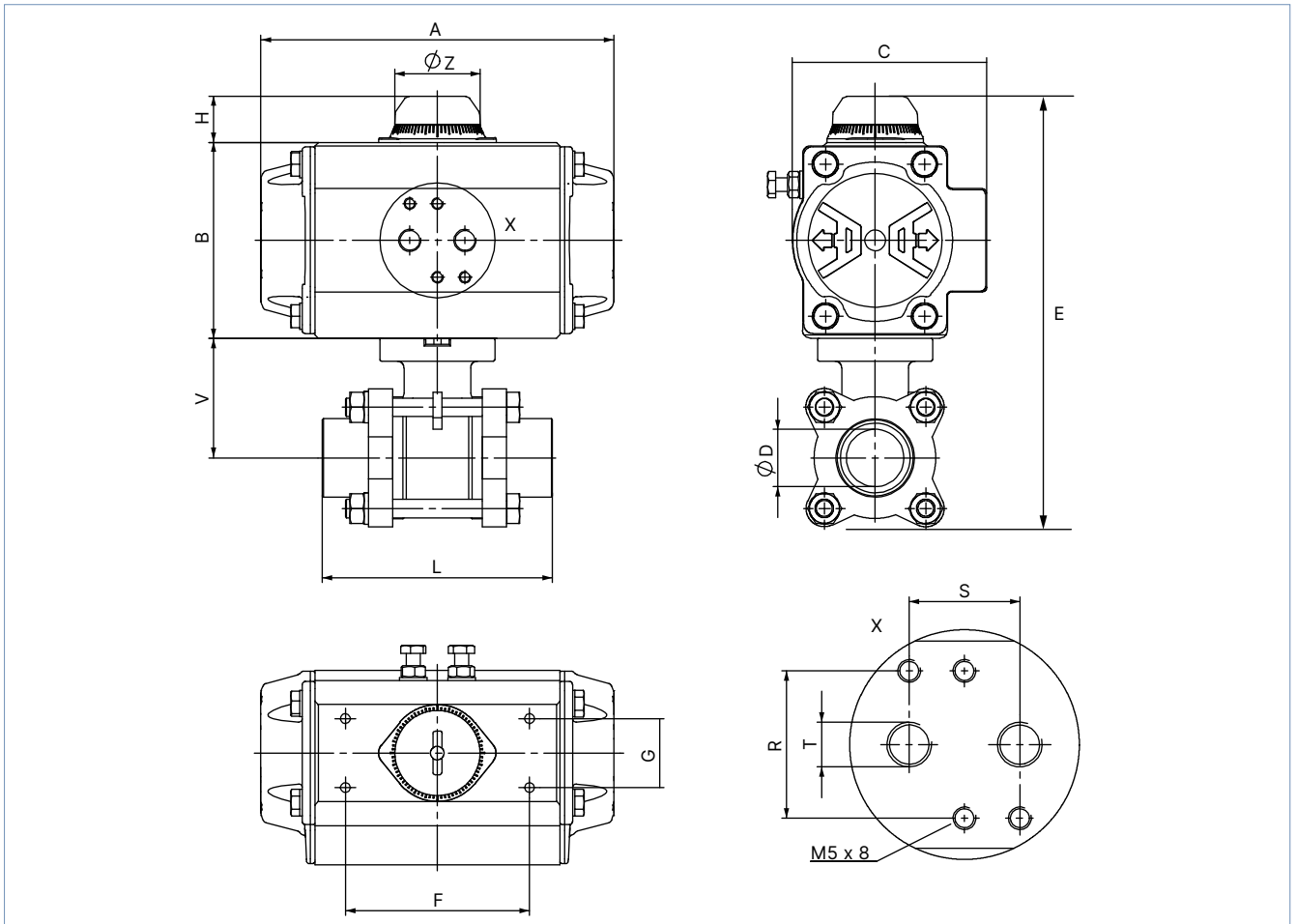

DTS 1000109493 EN Version: T Status: RL (released | freigegeben | validé) printed: 10.04.2025

Nominal diameter	Port connection [inch]	Actuator	Actuator dimensions											Valve dimensions		
			A [mm]	B [mm]	C [mm]	E [mm]	F [mm]	G [mm]	H [mm]	R [mm]	S [mm]	T [inch]	Ø Z [mm]	L [mm]	Ø D [mm]	V [mm]
12	3/8	15	136	69	72	155	80	30	20	32	24	1/8	37	70	12	40
15	1/2	15	136	69	72	171	80	30	20	32	24	1/8	37	75	15	40
		30	153.5	85	84.5		80	30	20	32	24	1/8	37			
20	3/4	15	136	69	72	177	80	30	20	32	24	1/8	37	90	20	44
		30	153.5	85	84.5		80	30	20	32	24	1/8	37			
25	1	15	136	69	72	206	80	30	20	32	24	1/8	37	100	25	52
		60	203.5	102	93		80	30	20	32	24	1/8	37			
32	1 1/4	30	153.5	85	84.5	217.5	80	30	20	32	24	1/8	37	110	32	58
		60	203.5	102	93		80	30	20	32	24	1/8	37			
40	1 1/2	30	153.5	85	84.5	245	80	30	20	32	24	1/8	37	125	40	68
		100	241	115	106		80	30	20	32	24	1/8	37			
50	2	60	203.5	102	93	262.5	80	30	20	32	24	1/8	37	150	50	77
		100	241	115	106		80	30	20	32	24	1/8	37			
65	2 1/2	100	241	115	106	309	80	30	20	32	24	1/8	37	190	65	98
		150	259	127	118.5		80	30	20	32	24	1/4	37			
80	3	150	259	127	118.5	370.5	80	30	20	32	24	1/4	37	220	80	110
		220	304	145	136		80	30	30	32	24	1/4	51			
100	4	150	259	127	118.5	422	80	30	20	32	24	1/4	37	270	100	138
		300	333	157	146.5		80	30	30	32	24	1/4	51			

5.5. 3/2-way ball valve, stainless steel body

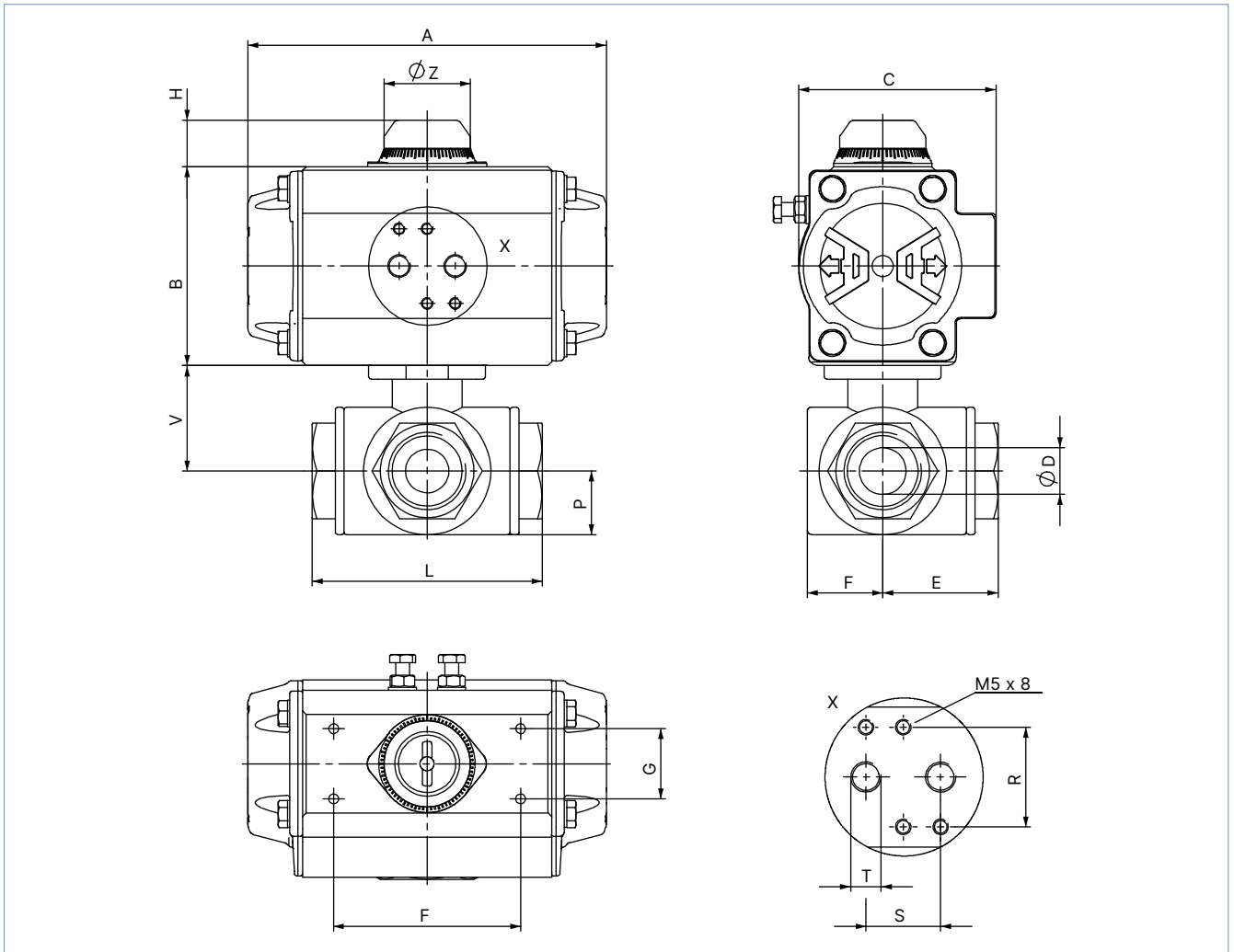

Nominal diameter	Port connection [inch]	Actuator	Actuator dimensions										Valve dimensions						
			A [mm]	B [mm]	C [mm]	F [mm]	G [mm]	H [mm]	R [mm]	S [mm]	T [inch]	ØZ [mm]	L [mm]	ØD [mm]	E [mm]	F [mm]	P [mm]	V [mm]	
12	¼	15	136	69	72	80	30	30	32	24	⅙	37	80	12	39.9	22	19.8	35.9	
		30	153.5	85	84.5	80	30	20	32	24	⅙	37							
12	⅜	15	136	69	72	80	30	20	32	24	⅙	37	80	12	39.9	22	19.8	35.9	
		30	153.5	85	84.5	80	30	20	32	24	⅙	37							
12	½	15	136	69	72	80	30	20	32	24	⅙	37	80	12	39.9	22	19.8	35.9	
		30	153.5	85	84.5	80	30	20	32	24	⅙	37							
15	¾	15	136	69	72	80	30	20	32	24	⅙	37	87.5	15	43.7	23	32.2	42.1	
		60	203.5	102	93	80	30	20	32	24	⅙	37							
20	1	30	153.5	85	84.5	80	30	20	32	24	⅙	37	100	20	46.5	32.4	27.2	46.5	
		60	203.5	102	93	80	30	20	32	24	⅙	37							
25	1¼	60	203.5	102	93	80	30	20	32	24	⅙	37	123	25	52.1	38.3	34.2	52.1	
		100	241	115	106	80	30	20	32	24	⅙	37							
32	1½	60	203.5	102	93	80	30	20	32	24	⅙	37	142.2	32	57.4	43	38.3	57.4	
		100	241	115	106	80	30	20	32	24	⅙	37							
40	2	100	241	115	106	80	30	20	32	24	⅙	37	170.6	40	66	56.2	49	66	
		150	259	127	118.5	80	30	20	32	24	¼	37							

DTS 1000109493 EN Version: T Status: RL (released | freigegeben | valide) printed: 10.04.2025

6. Performance specifications

6.1. Pressure temperature diagram

Note:

The temperature limits of the actuators are usually lower. Accordingly, for systems consisting of ball valve and actuator, it must be ensured that the temperature limits of the other system components (e.g. the actuators) are not exceeded due to possible heat radiation from the medium.

For general industrial use

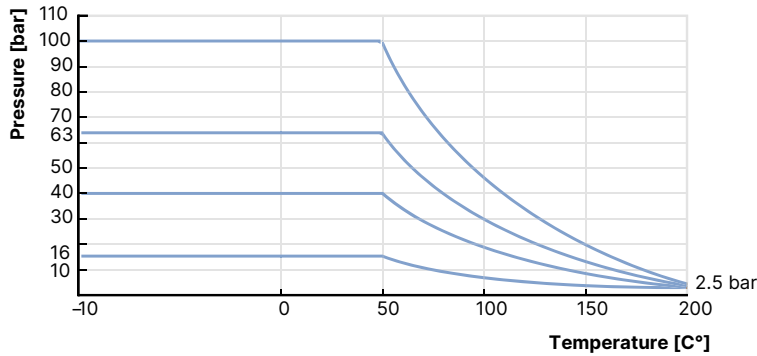

6.2. Switching position of the 3/2-way ball valves

Ball configuration	T			L
Position				
0°				
90°				
Switching position	T1	T2	T3	L4

6.3. Opening and closing times

For opening and closing times see chapter "Ordering chart accessories" see **operating instructions Type 2051** ▶.

7. Ordering information

7.1. Bürkert eShop



Bürkert eShop – Easy ordering and quick delivery

You want to find your desired Bürkert product or spare part quickly and order directly? Our online shop is available for you 24/7. Sign up and enjoy all the benefits.

[Order online now](#)

7.2. Bürkert product filter



Bürkert product filter – Get quickly to the right product

You want to select products comfortably based on your technical requirements? Use the Bürkert product filter and find suitable articles for your application quickly and easily.

[Try out our product filter](#)

7.3. Ordering chart 2/2-way ball valve

Note:

Stainless steel body (minimum pilot pressure 6 bar)

Control function	Nominal diameter	Port connection	K _v value		Nominal pressure ¹⁾		Actuator		Article no.		
			2 pieces	3 pieces	2 pieces	3 pieces	2 pieces	3 pieces	3 pieces, weld end port connection	2 pieces, threaded port connection	3 pieces, threaded port connection
			[mm]	[inch]	[m ³ /h]	[m ³ /h]	[bar]	[bar]			
A	10	¼	9	9	100	63	15	15	–	217232	217250
	12	⅜	13	13	100	63	15	15	217261	217233	217251
	15	½	19	19	100	63	30	30	217262	217234	217252
	20	¾	46	46	100	63	60	30	217263	217235	217253
	25	1	72	72	100	63	60	60	217264	217236	217254
	32	1¼	105	105	100	63	100	60	217265	217237	217255
	40	1½	170	170	100	63	150	100	217266	217238	217256
	50	2	275	275	100	63	220	100	217267	217239	217257
	65	2½	–	507	–	63	–	150	217268	–	217258
	80	3	–	905	–	63	–	220	217269	–	217259
	100	4	–	1414	–	63	–	300	217270	–	217260
B	10	¼	–	9	–	63	–	15	On request	On request	217292
	12	⅜	9	9	–	63	–	15	On request	On request	217293
	15	½	19	19	–	63	–	30	On request	On request	217294
	20	¾	46	46	–	63	–	30	On request	On request	217295
	25	1	72	72	–	63	–	60	On request	On request	217296
	32	1¼	105	105	–	63	–	60	On request	On request	217297
	40	1½	170	170	–	63	–	100	On request	On request	217298
	50	2	275	275	–	63	–	100	On request	On request	217299
	65	2½	–	507	–	63	–	150	On request	–	217300
	80	3	–	905	–	63	–	220	On request	–	217301
	100	4	–	1414	–	63	–	300	On request	–	217302
I	10	¼	9	9	100	63	15	15	–	217240	217271
	12	⅜	9	9	100	63	15	15	217282	217241	217272
	15	½	19	19	100	63	15	15	217283	217242	217273
	20	¾	46	46	100	63	30	15	217284	217243	217274
	25	1	72	72	100	63	30	15	217285	217244	217275
	32	1¼	105	105	100	63	60	30	217286	217245	217276
	40	1½	170	170	100	63	100	30	217287	217246	217277
	50	2	275	275	100	63	100	60	217288	217247	217278
	65	2½	–	507	–	63	–	100	217289	–	217279
	80	3	–	905	–	63	–	150	217290	–	217280
	100	4	–	1414	–	63	–	150	217291	–	217281

1) Operating pressure see "6.1. Pressure temperature diagram" on page 11

Further variants on request



Additional

- Nickel-plated brass ball valves
- Further connections and nominal diameters
- Non-standard fittings and variants

7.4. Ordering chart 2/2-way compact flange ball valve

Note:

Switching position 0°/90°

Control function	Nominal diameter	K _v value	Nominal pressure ¹⁾	Actuator	Weight	Article no.
	[mm]	[m ³ /h]	[bar]		[kg]	
A	20	46	40	30	3.8	217306
	25	72	40	60	6	217307
	32	105	40	60	7.7	217308
	40	170	40	100	9.8	217309
	50	275	40	150	12.8	217310
	65	507	16	220	20	217311
	80	905	16	300	26.3	217312
I	100	1414	16	300	29	217313
	20	46	40	15	2.1	217314
	25	72	40	30	4.4	217315
	32	105	40	30	6.2	217316
	40	170	40	60	8.1	217317
	50	275	40	60	9	217318
	65	507	16	100	14	217319
80	905	16	100	17.3	217320	
	100	1414	16	150	21.8	217321

1.) Operating pressure see "6.1. Pressure temperature diagram" on page 11











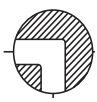







7.5. Ordering chart 3/2-way ball valve

Note:

- Reduced nominal diameter, minimum pilot pressure 6 bar, T2 and T3 on request
- Switching position 0°/90°

Switching position	Nominal diameter	Port connection	K _v value	Nominal pressure ¹⁾	Actuator single acting	Article no. single acting	Actuator double acting	Article no. double acting
	[mm]	[inch]	[m ³ /h]	[bar]	CF A	CF A	SF I	CF I
0°	10	1/4	4.7 / 6.9 ²⁾	63	30	217342	15	217352
	12	3/8	4.7 / 6.9 ²⁾	63	30	217343	15	217353
	12	1/2	6.9 / 11.2 ²⁾	63	30	217344	15	217354
	15	3/4	6.9 / 11.2 ²⁾	63	60	217345	15	217355
90°	20	1	18.9 / 29.2 ²⁾	63	60	217346	30	217356
	25	1 1/4	35.3 / 46.4 ²⁾	63	100	217347	60	217357
	32	1 1/2	46.4 / 72.2 ²⁾	63	100	217348	60	217358
	40	2	83.4 / 135.6 ²⁾	63	150	217349	100	217359

DTS 1000109493 EN Version: T Status: RL (released | freigegeben | valide) printed: 10.04.2025

Switching position	Nominal diameter	Port connection	K _v value	Nominal pressure ¹⁾	Actuator single acting	Article no. single acting	Actuator double acting	Article no. double acting
	[mm]	[inch]	[m ³ /h]	[bar]	CF A	CF A	SF I	CF I
L4 0° 	10	1/4	5.6	63	30	217325 	15	217333 
	12	3/8	5.6	63	30	217326 	15	217334 
	12	1/2	9.5	63	30	217327 	15	217335 
	15	3/4	9.5	63	60	217328 	15	217336 
90° 	20	1	25.8	63	60	217329 	30	217337 
	25	1 1/4	40.4	63	100	217330 	60	217338 
	32	1 1/2	60.2	63	100	217331 	60	217339 
	40	2	114.4	63	150	217332 	100	217340 

1.) Operating pressure see "6.1. Pressure temperature diagram" on page 11









2.) Switching position 0°/90°

7.6. Ordering chart accessories

Position feedback Type 1061

Note:

- Adjustable mounting bracket included
- For further variants see data sheet **Type 1061** ▶

Description	Article no.
Position feedback (electromechanical) (Typ 1061)	773151 
Position feedback (electromechanical) with integrated 3/2-way solenoid valve (Typ 1061)	773139 
Position feedback (electromechanical) with integrated 5/2-way solenoid valve (Typ 1061)	773140 
Position feedback (inductive) (Typ 1061)	773152 
Position feedback (inductive) with integrated 3/2-way solenoid valve (Typ 1061)	773141 
Position feedback (inductive) with integrated 5/2-way solenoid valve (Typ 1061)	773142 
Position feedback (inductive), ATEX variant (Typ 1061)	773153 
Position feedback (inductive) with integrated 3/2-way solenoid valve, ATEX variant (Typ 1061)	773143 
Position feedback (inductive) with integrated 5/2-way solenoid valve, ATEX variant (Typ 1061)	773144 

Positioner Type 8792

Note:

For further variants see data sheet **Type 8792** ▶.

Description	Article no.
Positioner SideControl without analogue feedback	317985 
Positioner SideControl with analogue feedback	317986 

Positioner mounting kit Type 8792/8793

Note:

For further variants see data sheet **Type 8792** ▶ or **Type 8793** ▶.

Description	Article no.
Universal adapter for stem	787338 
Universal mounting bracket	770294 

Type 6519 NAMUR

Note:

- Only recommended up to actuator size 220
- For further information see data sheet (NAMUR variant) **Type 6519** ▶.

Control function	Nominal diameter	Seal material body	Material of thread insert ¹⁾	Port connection threaded port	Q _N value	Pressure range ³⁾	Weight	Nominal power	Voltage/frequency	Article no.
	[mm]				[l/min]					
CF C ¹⁾	6	NBR and PUR	Stainless steel	G ¼	900	2...8	460	2	24/DC	131425
									24/50...60	131426
									110/50...60	131427
									230/50...60	131428
CF H ²⁾	6	NBR and PUR	Nickel-plated brass	G ¼	900	2...8	460	2	24/DC	131421
									24/50...60	131422
									110/50...60	131423
									230/50...60	131424

1.) 3/2-way solenoid valve servo-controlled, with manual override, normally closed

2.) 5/2-way solenoid valve servo-controlled, with manual override, pressure applied via port (1), therefore one of the two ports (2) or (4) is under pressure.

Cable plug Type 2518, Form A according to DIN EN 175301...803

Note:

For further variants see data sheet **Type 2518** ▶.

Cable plug	Dimensions	Variant	Voltage	Article no.
		Without circuitry (AC/DC)	0...250 V AC/DC	314802
		With LED (AC/DC)	12...24 V AC/DC	314812
		With LED and varistor (AC/DC)	12...24 V AC/DC	314820
		With rectifier, LED and varistor	12...24 V AC/DC	314816

Reducing sleeves

Description	Article no.
Reducing sleeve double square/square 14/9 mm	665288
Reducing sleeve double square/square 14/11 mm	665289
Reducing sleeve square/square 17/14 mm	665290
Reducing sleeve double square/square 17/14 mm	773348
Reducing sleeve double square/square 17/11 mm	773343
Reducing sleeve square/square 22/19 mm	773836
Reducing sleeve double square/square 22/17 mm	684858
Reducing sleeve double square/double square 22/14 mm	666684
Reducing sleeve double square/square 22/11 mm	773344
Reducing sleeve double square/square 27/22 mm	774594
Reducing sleeve square/square 27/19 mm	774279
Reducing sleeve square/square 27/17 mm	774193

DTS 1000109493 EN Version: T Status: RL (released | freigegeben | validé) printed: 10.04.2025