





Pressure controller for precise time-pressure dosing

- Repeatable and accurate dosing of liquids in the μl range
- Response time in milliseconds and active pressure relief for optimum control performance
- Digital communication for easy integration into your fieldbus network
- Extended functionality through additional sensor input + actuator output e.g. for pump or additional pressure sensor
- Active vent valve to minimize consumption of costly carrier gas

Product variants described in the data sheet may differ from the product presentation and description.

Can be combined with

	Type 6712 2/2-way Whisper Valve with media separation	▶
	Type 6724 2/2 or 3/2-way Whisper Valve with media separation	▶
	Type ME43 Fieldbus gateway	▶
	Type 6650 2/2-way Flipper-Solenoid Valve with separating diaphragm	▶
	Type 8920 Bürkert Communicator	▶

Type description

Time-pressure dosing is a widely used method for the reliable dosing of liquids across numerous fields of application. However, if dosing quantities are very small and the pressure differences between dosing cycles are minimal, closed-loop control becomes a challenge. Precisely the type of challenge for the pressure regulator Type 8763, which was specially developed for low flow rates and the resulting small dosing quantities. The device is characterised by short response times and precise closed-loop control of pressure. There are no down times or rejects at the beginning of dosing cycles. The digital interface makes it possible to access the various parameters at any time in order to change settings and read out data. Whether you are operating filling systems or state-of-the-art machines for genetic analysis and synthesis, a good valve alone is not enough. Precise pressure regulation is also essential for accuracy in time-pressure dosing. Only in this way can accurate dosing be implemented.

Table of contents

1. General technical data	3
2. Approvals and conformities	3
2.1. General notes.....	3
2.2. Conformity	3
2.3. Standards.....	3
3. Materials	4
3.1. Bürkert resistApp	4
3.2. Materials in the fluid channel	4
4. Dimensions	5
4.1. Digital and analogue variant with port connections.....	5
4.2. Digital and analogue variant with flange connection	6
5. Device/Process connections	7
5.1. Electrical connections.....	7
6. Performance specifications	8
6.1. Dosing examples.....	8
General structure	8
Dosing example for a dosing time of 50 ms	8
Dosing example for a dosing time of 500 ms	9
Dosing example for varying target pressure	9
6.2. Flow characteristic	10
Flow rate of variants with pressure ratio “target pressure to supply pressure” ($p_1:p_2$).....	10
7. Ordering information	11
7.1. Bürkert eShop.....	11
7.2. Bürkert Produktfilter	11
7.3. Ordering chart	12
7.4. Ordering chart accessories.....	12

1. General technical data

Product properties	
Dimensions	Further information can be found in chapter "4. Dimensions" on page 5.
Temperature compensation	Yes
Filter	36 µm input filter
Performance data	
Supply pressure p_1	0.2...3 bar / 2.9...43.5 Psi (supply pressure > target pressure) variants up to 2 bar control pressure 0.5...6 bar / 7.3...87.0 Psi (supply pressure > target pressure) variants up to 5 bar control pressure
Gas control volume	30...3000 ml (adjustable from 2 ml)
Reaction time	< 25 ms (sensor captures and adjustment of the control valve) Target pressure change 0...1 bar (0...14.5 Psi): typically 600 ms (supply pressure 3 bar (43.5 Psi) at 30 ml)
Control range/Control accuracy in steady state	0.006...0.35 bar / 0.087...5.08 Psi (± 1.225 mbar / 0.0178 Psi) ^{1.)} 0.02...1.0 bar / 0.29...14.5 Psi (± 3.5 mbar / 0.051 Psi) ^{1.)} 0.04...2.0 bar / 0.58...29 Psi (± 7 mbar / 0.10 Psi) ^{1.)} 0.2...5.0 bar / 2.9...72.5 Psi (± 25 mbar / 0.363 Psi) ^{1.)}
Reproducibility and control accuracy according to Bürkert standard measuring setup ^{2.)}	< ± 0.35 % FS for 0.35 to 2 bar variants < ± 0.75 % FS for 5 bar variants
Electrical data	
Operating voltage	18...35 V DC
Power consumption	< 6 W (typically 2.4 W, with connected additional loads < 12 W)
Medium data	
Operating medium	Air, non-flammable, neutral, oil-free gases (nitrogen, argon), oil-free
Medium temperature	+ 15...+ 40 °C
Process/Port connection & communication	
Input	G 1/8" or flange
Outputs	
Output controlled	UNF 1/4" ...28 or flange
Output switched (pressure relief)	Ventilation hole or flange Further information can be found in chapter "4. Dimensions" on page 5.
Approvals and conformities	
Protection class	IP20
Certified materials	On request
Environment and installation	
Ambient temperature	+ 15...+ 40 °C (for high control quality) Extension on request

1.) "In steady state" means constant flow of medium

2.) 30 ml volume

2. Approvals and conformities

2.1. General notes

- The approvals and conformities listed below must be stated when making enquiries. This is the only way to ensure that the product complies with all required specifications.
- Not all available versions can be supplied with the below mentioned approvals or conformities.

2.2. Conformity

In accordance with the Declaration of Conformity, the product is compliant with the EU Directives.

2.3. Standards

The applied standards which are used to demonstrate compliance with the EU Directives are listed in the EU-Type Examination Certificate and/or the EU Declaration of Conformity.

3. Materials

3.1. Bürkert resistApp

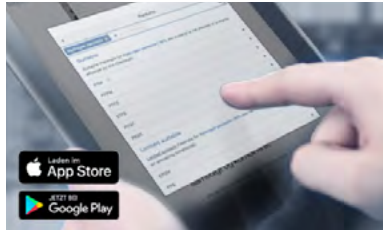

Bürkert resistApp – Chemical Resistance Chart

You want to ensure the reliability and durability of the materials in your individual application case? Verify your combination of media and materials on our website or in our resistApp.

[Start Chemical Resistance Check](#)

3.2. Materials in the fluid channel

The materials at the pressure inlet and outlet are described below. In the case of venting, the materials of the pressure outlet are in direct contact with any outgassing media. Wetted materials are PPS and FFKM.

The control system is designed in such a way that when venting through the core hole, the outgassed media do not come into contact with the materials on the pressure inlet side, i.e. FKM, PTFE, brass and stainless steel.

Note:

Other materials are available on request.

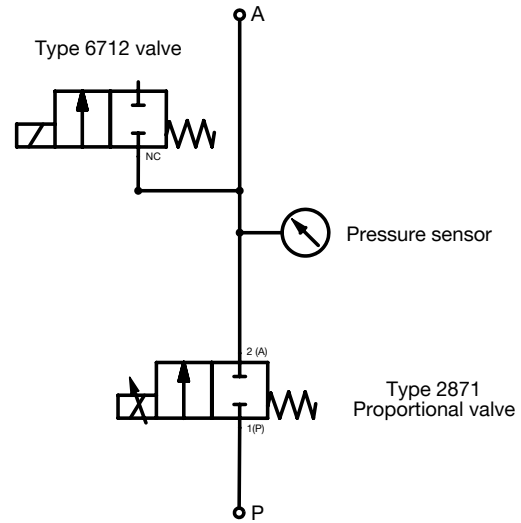
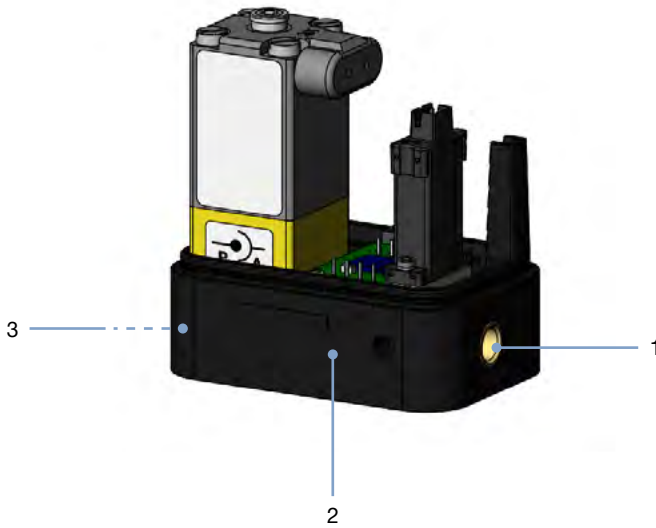

No.	Element	Material of standard variant	Material of flange variant
1	Pressure outlet	PPS and FFKM	PEEK, FFKM
2	Pressure sensor	Silicon, FKM	Silicon, FKM
3	Pressure input	Brass and stainless steel, FKM, PTFE	PTFE, brass or stainless steel, FKM

4. Dimensions

4.1. Digital and analogue variant with port connections

Note:

Dimensions in mm

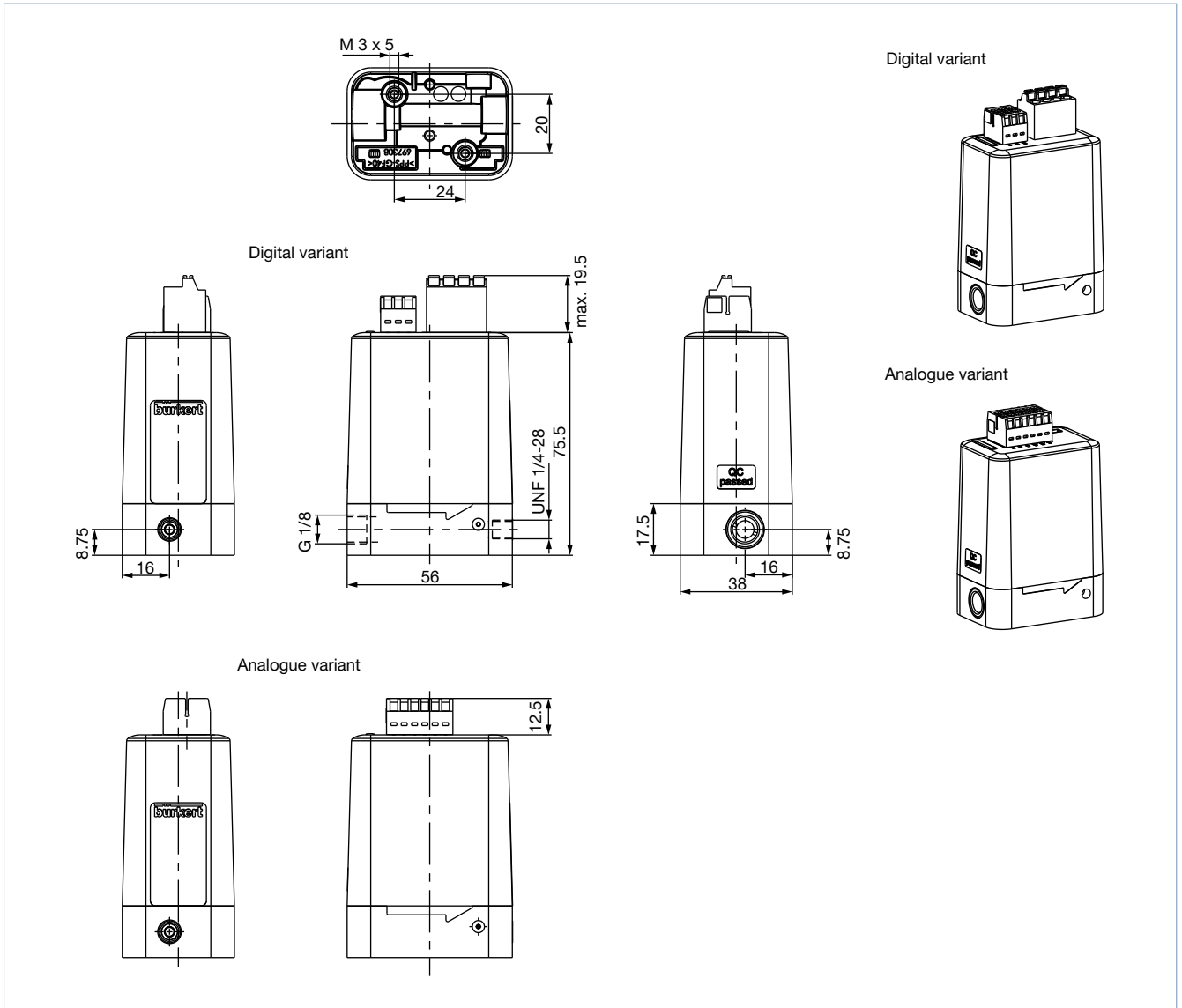

4.2. Digital and analogue variant with flange connection

Note:

Dimensions in mm

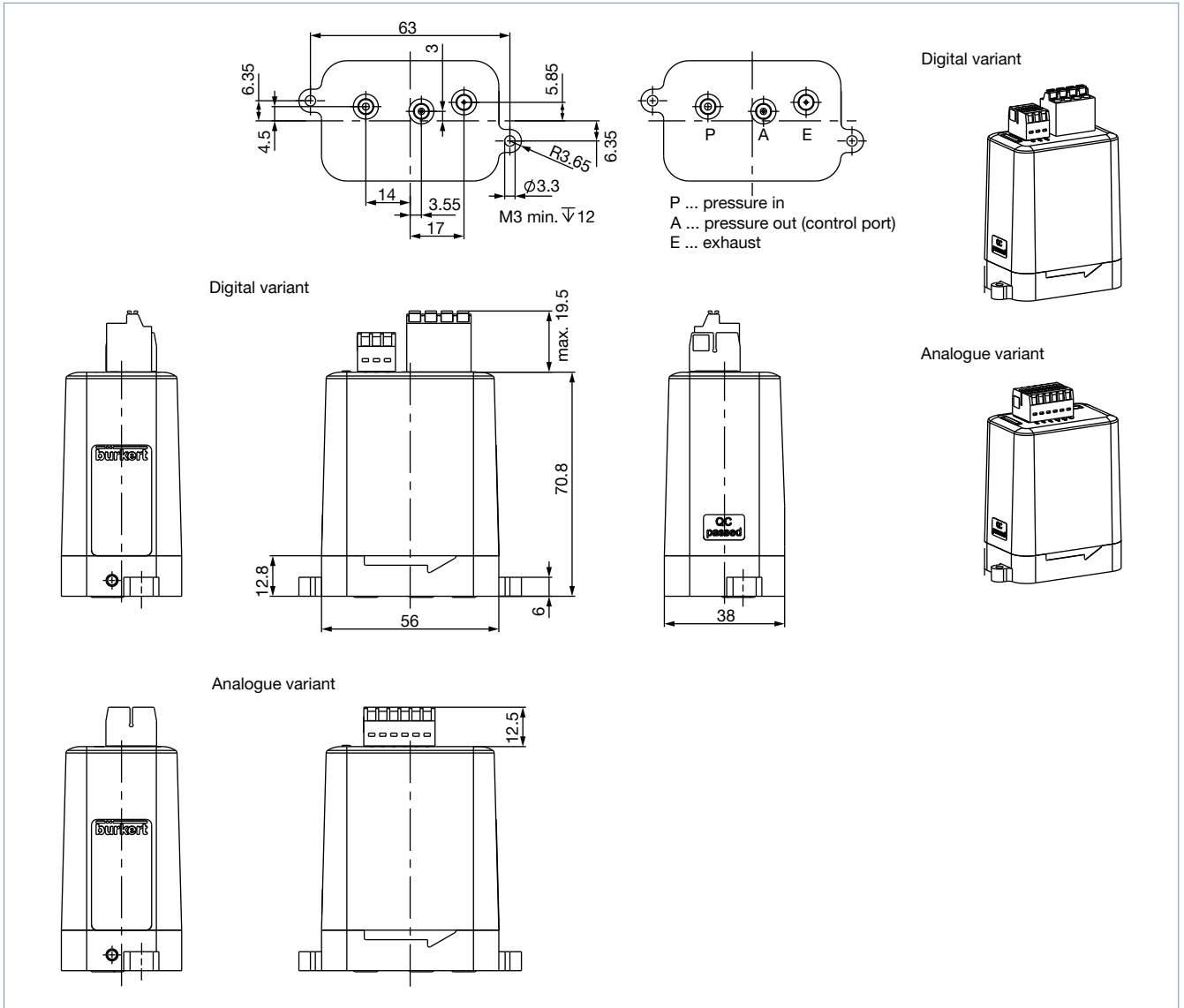

DTS 1000398869 EN Version: G Status: RL (released | freigegeben | validé) printed: 18.06.2024

5. Device/Process connections

5.1. Electrical connections

Digital

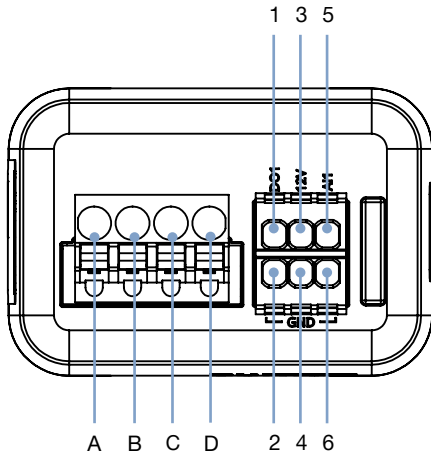

No.	Assignment
A	GND (input)
B	CAN low
C	CAN high
D	18...35 V DC
1	DO1 12 V DC, e.g. switchable pump
2	GND
3	Output voltage for sensor supply 12 V DC
4	GND
5	AI1 (external sensor input)
6	GND

Analogue

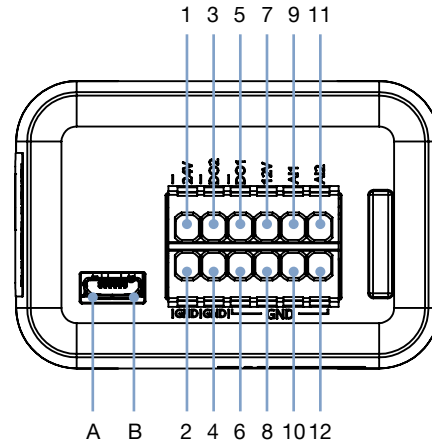

No.	Assignment	No.	Assignment
A	CAN high (service büS)	6	GND
B	CAN low (service büS)	7	Output voltage for sensor supply 12 V DC
1	18...35 V DC	8	GND
2	GND (input)	9	AI1 Analog In for sensor, e.g. pump control
3	DO2 (binary output)	10	GND
4	GND (binary output)	11	AI2 Analog In for set pressure specification
5	DO1 12 V DC, e.g. switchable pump	12	GND

6. Performance specifications

6.1. Dosing examples

General structure

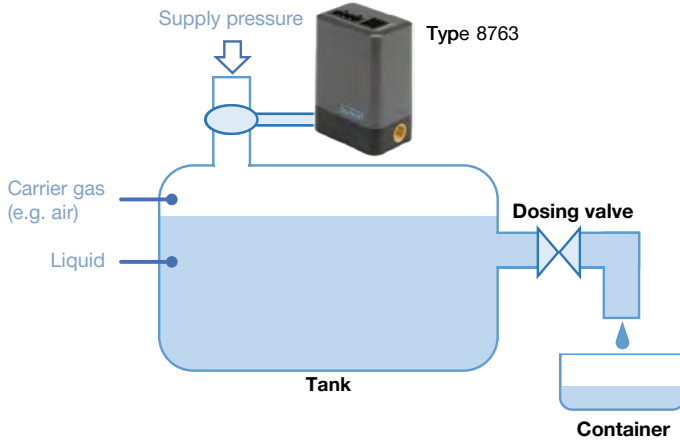

Dosing example for a dosing time of 50 ms

Type 8763 (Article no.: 318290)	
Parameter	Value
Supply pressure	2 bar (29 Psi)
Container air volume	50 ml
Dosing valve	Article no.: 273203
Dosing time/valve switching time	50 ms
Dosing medium	Water
Length of tank hose	500 mm
Cross-section of tank hose	2.36 mm
Hose length of tank dosing valve	350 and 200 mm
Hose cross-section of tank dosing valve	1.58 mm
Target pressure	138 mbar (2 Psi)
Dead band	0.05 %

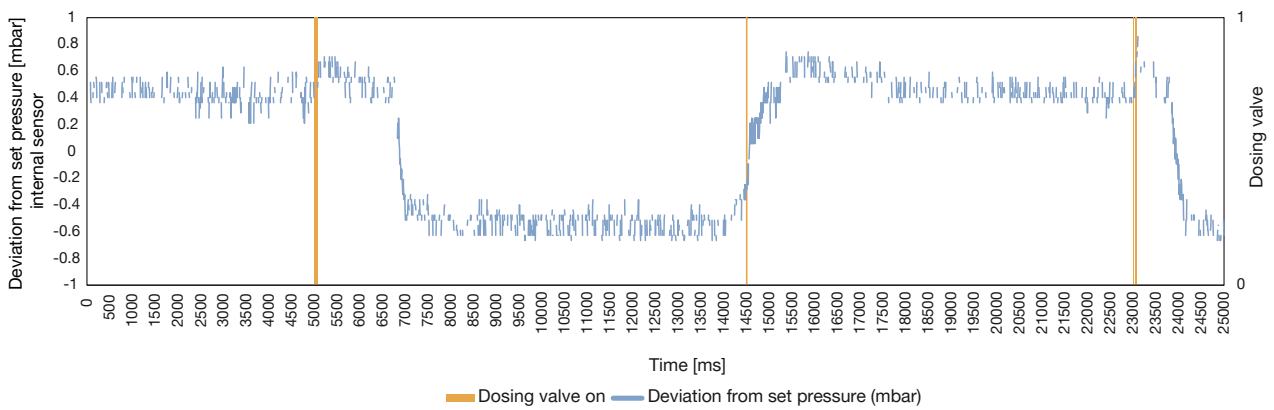

DTS 1000398869 EN Version: G Status: RL (released | freigegeben | valide) printed: 18.06.2024

Dosing example for a dosing time of 500 ms

Type 8763 (Article no.: 318290)	
Parameter	Value
Supply pressure	2 bar (29 Psi)
Container air volume	50 ml
Dosing valve	Article no.: 273203
Dosing time/valve switching time	500 ms
Dosing medium	Water
Length of tank hose	500 mm
Cross-section of tank hose	2.36 mm
Hose length of tank dosing valve	350 and 200 mm
Hose cross-section of tank dosing valve	1.58 mm
Target pressure	500 mbar (7.25 Psi)
Dead band	0.05 %

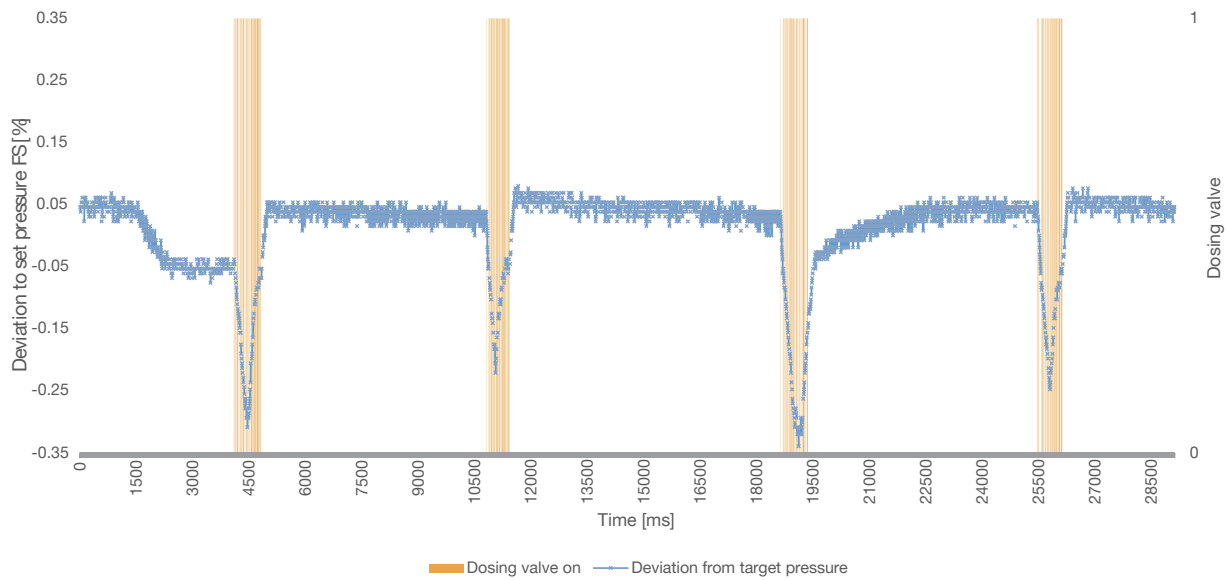

Dosing example for varying target pressure

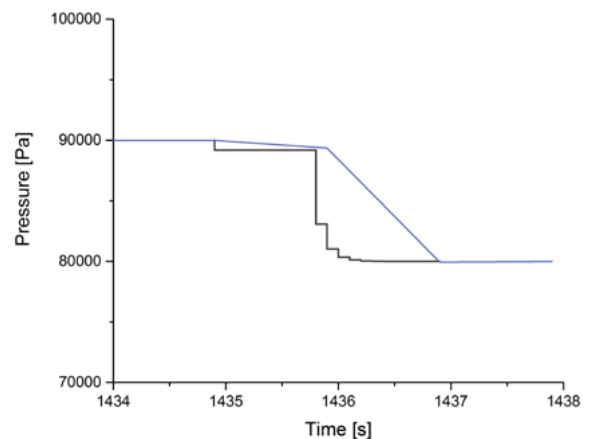
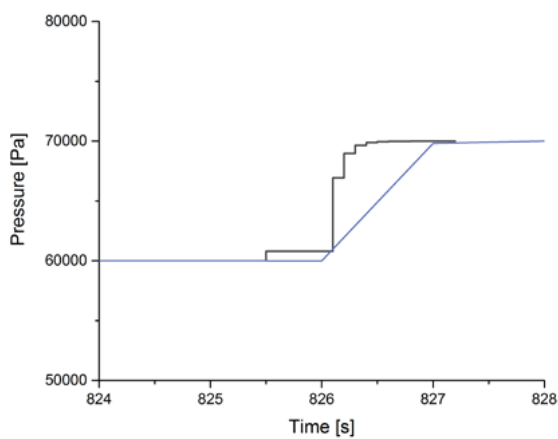

Target pressure ———

Actual pressure ———

6.2. Flow characteristic

Flow rate of variants with pressure ratio “target pressure to supply pressure” (p_2/p_1)

Note:

See following page for an example how to determine the required flow rate.

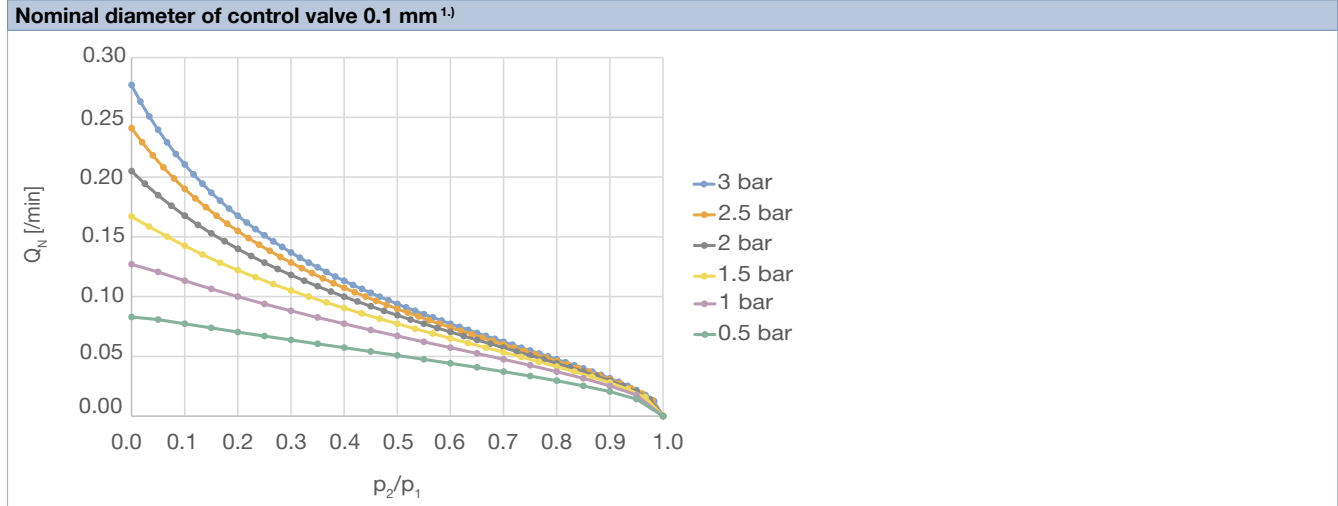

1.) p_2 = target pressure, p_1 = supply pressure

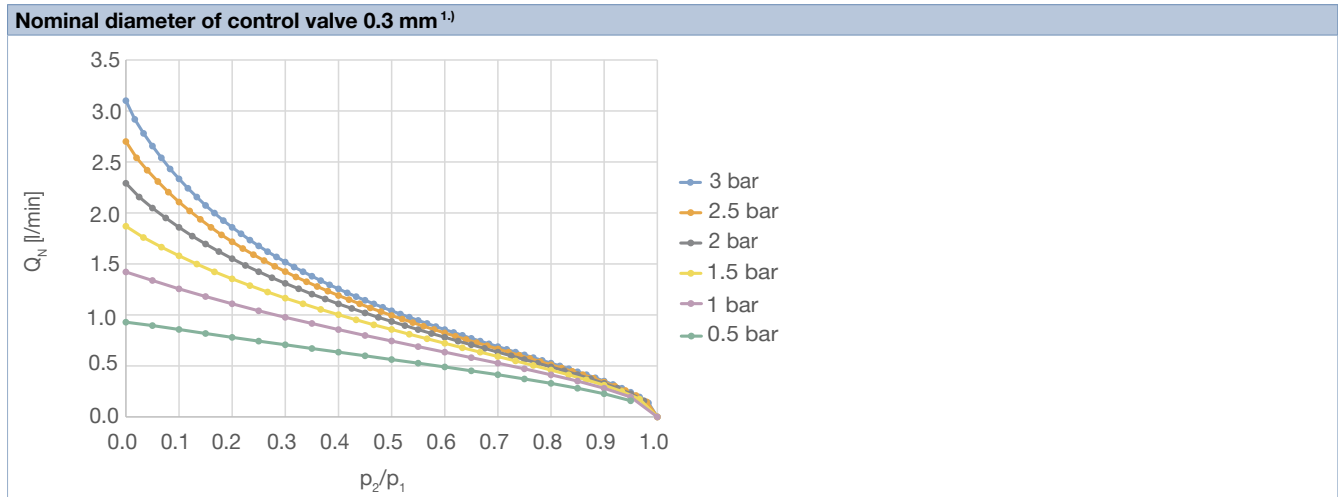

1.) p_2 = target pressure, p_1 = supply pressure

DTS 1000398869 EN Version: G Status: RL (released | freigegeben | valide) printed: 18.06.2024

How to determine the required flow rate (example)	
<p>Nominal diameter of control valve 0.3 mm^{1.)}</p>	<p>Calculation</p> <p>Sizing of the pressure regulator Below are some notes on sizing the supply pressure and target pressure to a desired dosing rate. It should be noted that real pressures must be higher because the calculation cannot consider the individual friction loss of the lines in the application.</p> <p>Step #1 Calculating the flow rate Example application with a dosing shot of 15 ms and 220 µl volume (220 µl / 15 ms) x 1000 = 14666 µl/s x 60 = 880000 µl/min = 0.88 l/min flow rate</p> <p>Step #2 Ratio target pressure / supply pressure DN 0.1 is too small → DN 0.3 mm minimum required Note: A low target pressure (300...500 mbar) has a beneficial effect on the dosing accuracy.</p> <p>Step #3 Determine supply pressure p₁</p>

1.) p₂ = target pressure, p₁ = supply pressure

7. Ordering information

7.1. Bürkert eShop



Bürkert eShop – Bequem bestellt und schnell geliefert

Sie möchten Ihr gewünschtes Bürkert-Produkt oder Ersatzteil schnell finden und direkt bestellen? Unser Onlineshop ist rund um die Uhr für Sie erreichbar. Melden Sie sich gleich an und nutzen Sie die Vorteile.

[Jetzt online einkaufen](#)

7.2. Bürkert Produktfilter



Bürkert Produktfilter - Schnell zum passenden Produkt













Sie möchten anhand Ihrer technischen Anforderungen einfach und bequem selektieren? Nutzen Sie den Bürkert Produktfilter und finden Sie unseren passenden Artikel für Ihre Anwendung.

[Jetzt Produkte filtern](#)

7.3. Ordering chart







Note:

All electrical plugs are included in the scope of delivery.

Pressure range	Nominal diameter control valve ^{1.)}	Electrical connection	Fluidic connection	Article no.
[bar (Psi)]	[mm]		Input/output	
0.006...0.35 (0.087...5.08)	0.1	Analogue	G 1/8 / UNF 1/4...28	318289 
0.006...0.35 (0.087...5.08)	0.1	Digital	G 1/8 / UNF 1/4...28	318288 
0.02...1 (0.3...14.5)	0.3	Analogue	G 1/8 / UNF 1/4...28	318292 
0.02...1 (0.3...14.5)	0.3	Digital	G 1/8 / UNF 1/4...28	318290 
0.04...2 (0.6...29)	0.3	Analogue	G 1/8 / UNF 1/4...28	318293 
0.04...2 (0.6...29)	0.3	Digital	G 1/8 / UNF 1/4...28	318291 
0.006...0.35 (0.087...5.08)	0.1	Analogue	Flange pattern FB51	381013 
0.006...0.35 (0.087...5.08)	0.1	Digital	Flange pattern FB51	381012 
0.02...1 (0.3...14.5)	0.3	Analogue	Flange pattern FB51	381018 
0.02...1 (0.3...14.5)	0.3	Digital	Flange pattern FB51	381015 
0.04...2 (0.6...29)	0.3	Analogue	Flange pattern FB51	381019 
0.04...2 (0.6...29)	0.3	Digital	Flange pattern FB51	381017 
0.2...5 (2.9...72.5)	0.3	Digital	Flange pattern FB51	393266 

1.) Other variants on request

7.4. Ordering chart accessories

Description	Article no.
USB bÜS interface set 1 (Type 8923) for connection to the Bürkert Communicator software: includes connection cable (M12 and micro USB), stick with integrated terminating resistor, power supply and software	772426 
Plug, digital variant (bÜS)	920299 
Plug, digital variant (sensor supply/actuator)	920245 
Plug, analogue variant	920225 
Manifold for Type 8763 flange pattern FB51 with 3 G 1/8 cable connections	394687 
Gas/air pump SP 570 EC, 12 V DC (250 mA), ≥2 l/min, ≥1000 mbar	906327 
Gas/air pump SP 600 EC-DV, 12 V DC (400 mA), ≥3 l/min, ≥1300 mbar	906379 
Gas/air pump SP 620 EC-BL-DV, 12 V DC (500 mA) ≥2.8 l/min, ≥1300 mbar, brush-free	906380 