

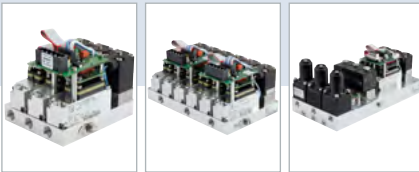

Multi-channel mass flow controller (MFC) / multi-channel mass flow meter (MFM) for gases

- Nominal flow ranges from 0.01 I_N/min to 20 I_N/min
- High accuracy and repeatability
- Very fast response times
- 2 to 8 channels available
- Tailor-made system



Product variants described in the data sheet may differ from the product presentation and description.

Can be combined with



Type ME43
Fieldbus gateway



Type description

Type 8735 forms the basis of the modular and economical multi-channel flow control systems for gases. The semi-standardised modular system consists of assemblies that can be put together flexibly and according to requirements. At the heart of the system are the thermal mass flow controllers / meters (MFCs/MFMs) for gases. Therefore, Type 8735 enables tailor-made solutions without generating long development times and costs. Multi-channel MFC/MFM systems Type 8735 are aimed at applications with several control loops and high volumes. For example, laboratory analysis equipment for spectroscopy or gas chromatography.

Table of contents

1. General technical data	3
<hr/>	
2. Approvals and conformities	4
2.1. General notes	4
2.2. Conformity	4
2.3. Standards	4
2.4. Foods and beverages/Hygiene	4
2.5. Oxygen	4
2.6. Others	4
<hr/>	
3. Materials	4
3.1. Bürkert resistApp	4
<hr/>	
4. Dimensions	5
4.1. 3-channel control system	5
<hr/>	
5. Product connections	6
5.1. Communication	6
I ² C interface with büS/CANopen	6
Modbus RTU/RS-485 interface with büS/CANopen	7
<hr/>	
6. Product operation	8
6.1. Measurement principle	8
<hr/>	
7. Product accessories	9
7.1. Bürkert Communicator Software	9
<hr/>	
8. Ordering information	10
8.1. Bürkert eShop	10
8.2. Bürkert product filter	10
8.3. Bürkert Product Enquiry Form	10
8.4. Ordering chart accessories	10

DTS 1000444910 EN Version: H Status: RL (released | freigegeben | valide) printed: 20.05.2026

1. General technical data

Product properties	
Dimensions	Further information can be found in chapter “4. Dimensions” on page 5.
Material	
Seal	FKM or EPDM (depending on gas)
Fluidics	PPS, stainless steel 1.4404/316L or others
MFM basic block	Aluminium
System basic block	Aluminium or stainless steel
Total weight	3-channel MFC system: approximately 750 g
Performance data	
Nominal flow rate (Q_N)	0.05 I_N /min...20 I_N /min (N_2)
Maximum operating pressure ¹⁾	MFM: max. 6 bar For MFCs, the maximum operating pressure depends on the medium and nominal valve size.
Measuring accuracy	$\pm 1.5\% \text{ MV}^{2)}$ $\pm 0.3\% \text{ FS}^{3)}$ (under calibration conditions)
Repeatability	$\pm 0.15\% \text{ FS}^{2)}$
Turndown ratio	1:50 (higher on request)
Settling time (t95)	< 700 ms (without output filter < 100 ms)
Control valve (proportional valve)	Type 2871 (normally closed)
Electrical data	
Operating voltage	24 V DC (standardised electronics)
Power consumption	Typically 8 W (3-channel MFC system) MFC systems: depending on the number of control loops and the valve power consumption
Residual ripple	$\pm 2\%$
Voltage tolerance	$\pm 10\%$
Electrical connection	
büS/CANopen/I ² C variant	Terminal strip, 5-pin
Modbus RTU variant	D-Sub plug, 9-pin
Medium data	
Operating medium	Air, oxygen, nitrogen, argon, methane (≤ 20 l/min) Hydrogen, helium (≤ 70 l/min) Carbon dioxide (≤ 10 l/min) Propane (≤ 6 l/min)
Calibration medium	Operating gas or air
Medium temperature	0 °C...+ 50 °C
Product connections	
Port connection	G 1/8, NPT 1/8 (others on request)
Digital communication interface	I ² C, büS/CANopen, Modbus RS-485/RTU list 0 and list 1
Approvals and conformities	
Foods and Beverages/Hygiene	Further information can be found in chapter “2.4. Foods and beverages/Hygiene” on page 4.
Oxygen	Further information can be found in chapter “2.5. Oxygen” on page 4.
Environment and installation	
Installation position	Horizontal or vertical
Degree of protection	IP00
Ambient temperature	0 °C...+ 50 °C
Accessories	
Software	Bürkert Communicator Further information can be found in chapter “7.1. Bürkert Communicator Software” on page 9.

1) Overpressure to atmospheric pressure

2.) Of measured value

3.) Of full scale

2. Approvals and conformities

2.1. General notes

- The approvals and conformities listed below must be stated when making enquiries. This is the only way to ensure that the product complies with all required specifications.
- Not all available variants can be supplied with the below mentioned approvals or conformities.

2.2. Conformity

In accordance with the Declaration of Conformity, the product is compliant with the EU Directives.

2.3. Standards

The applied standards which are used to demonstrate compliance with the EU Directives are listed in the EU-Type Examination Certificate and/or the EU Declaration of Conformity.

2.4. Foods and beverages/Hygiene

Conformity	Description
FDA	FDA – Code of Federal Regulations (valid for variable code PL02, PL03) All wetted materials are compliant with the Code of Federal Regulations published by the FDA (Food and Drug Administration, USA) according to the manufacturer’s declaration.
USP	United States Pharmacopeial Convention (USP) (valid for variable code PL04) All wetted materials are biocompatible according to the manufacturer’s declaration.

2.5. Oxygen

Conformity	Description
O ₂	Optional: Suitability for oxygen (valid for the variable code NL02 und NL85) The products are suitable for use with gaseous oxygen, according to the manufacturer’s declaration.

2.6. Others

Type 8735 is an OEM component for the integration in a higher-level device. Type 8735 has got CE declaration for ROHS, see **Type 8735** ▶ or contact your Bürkert partner.

Because Type 8735 has no housing as standard, an evaluation according to EMC is not possible and must be taken over by the customer.

3. Materials

3.1. Bürkert resistApp

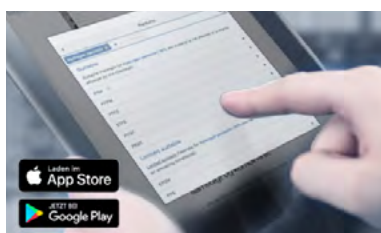

Bürkert resistApp – Chemical Resistance Chart

You want to ensure the reliability and durability of the materials in your individual application case? Verify your combination of media and materials on our website or in our resistApp.

[Start Chemical Resistance Check](#)

DTS 1000444910 EN Version: H Status: RL (released | freigegeben | valide) printed: 20.05.2026

4. Dimensions

4.1. 3-channel control system

Note:

Dimensions in mm

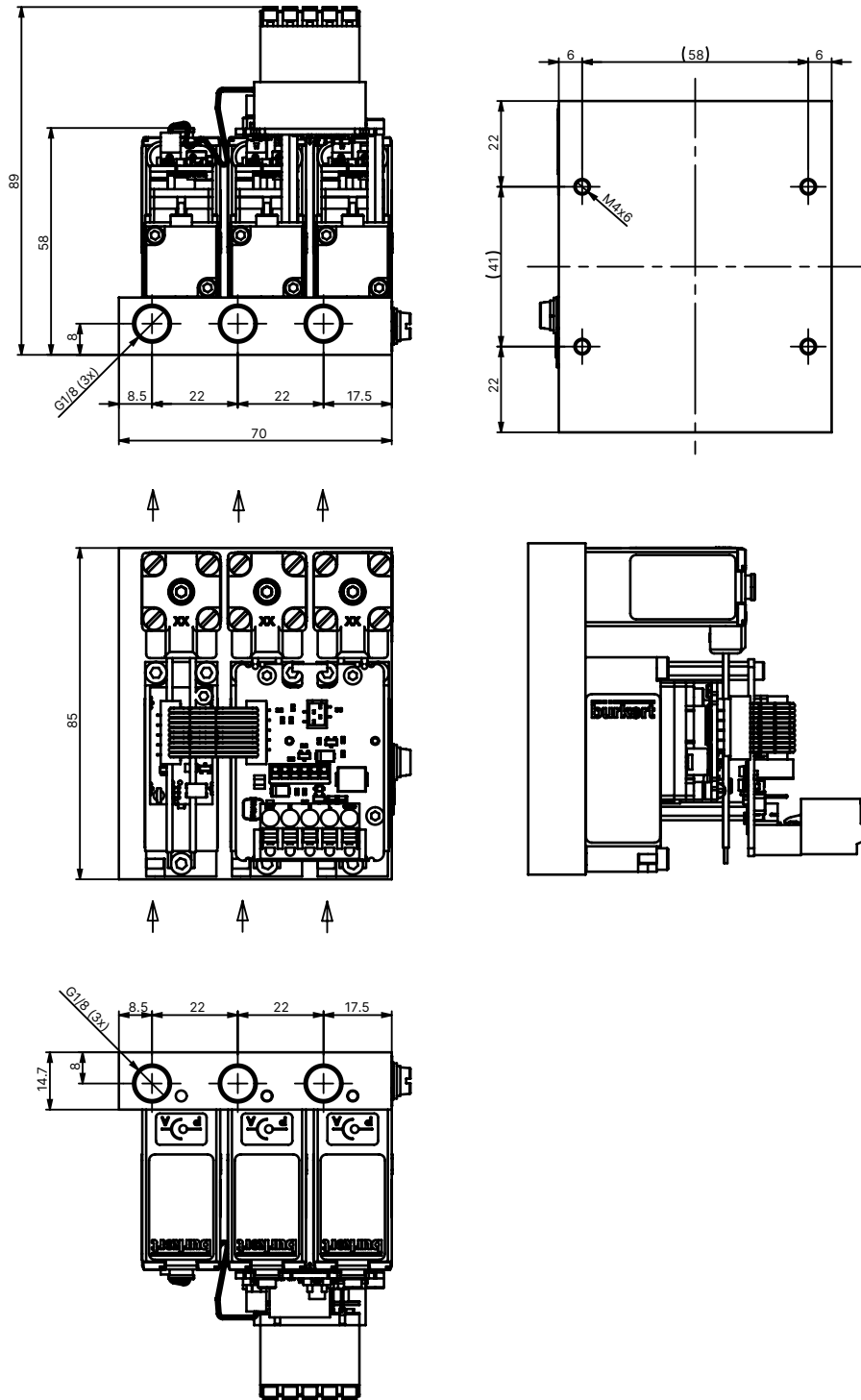

5. Product connections

5.1. Communication

I²C interface with büS/CANopen

Board

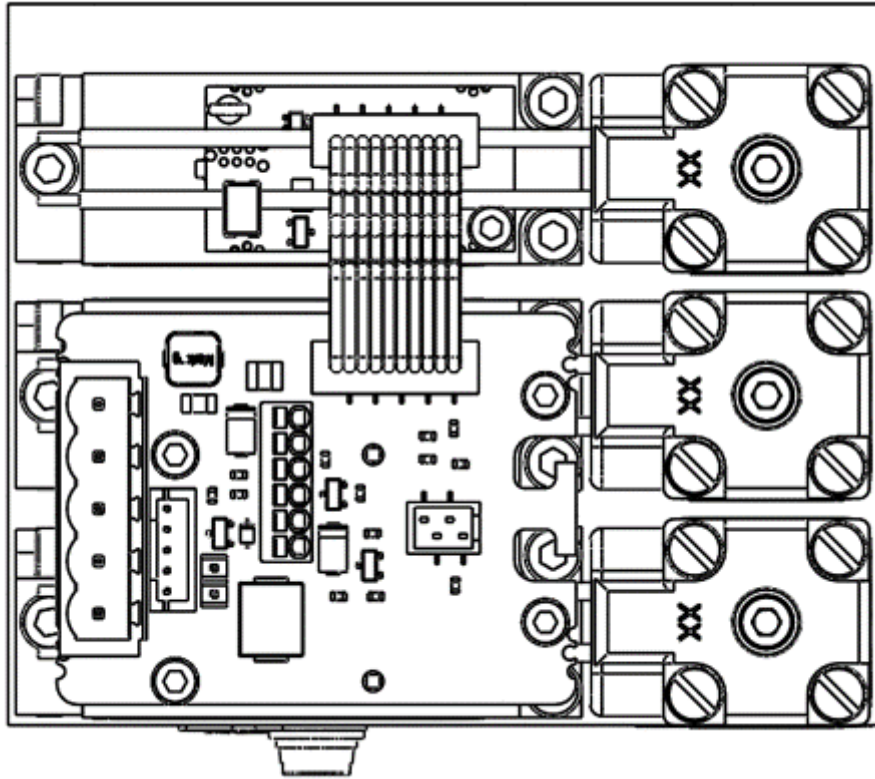

Assignment

büS/CANopen spring-loaded terminal, 5-pin	Pin	Assignment	Colour
	1	24 V	Red
	2	CAN_H	White
	3	Shielding	Green
	4	CAN_L	Blue
	5	GND	Black
Micro Match 1.27 mm, 4-pin	Pin	Assignment	
	1	I ² C SDA	
	2	VDD 3.3 V DC	
	3	GND	
	4	I ² C SCL	
JST plug-in connector, 5-pin	Pin	Assignment	
	1	24 V	
	2	CAN_H	
	3	Shielding	
	4	CAN_L	
	5	GND	

Modbus RTU/RS-485 interface with büS/CANopen

Board

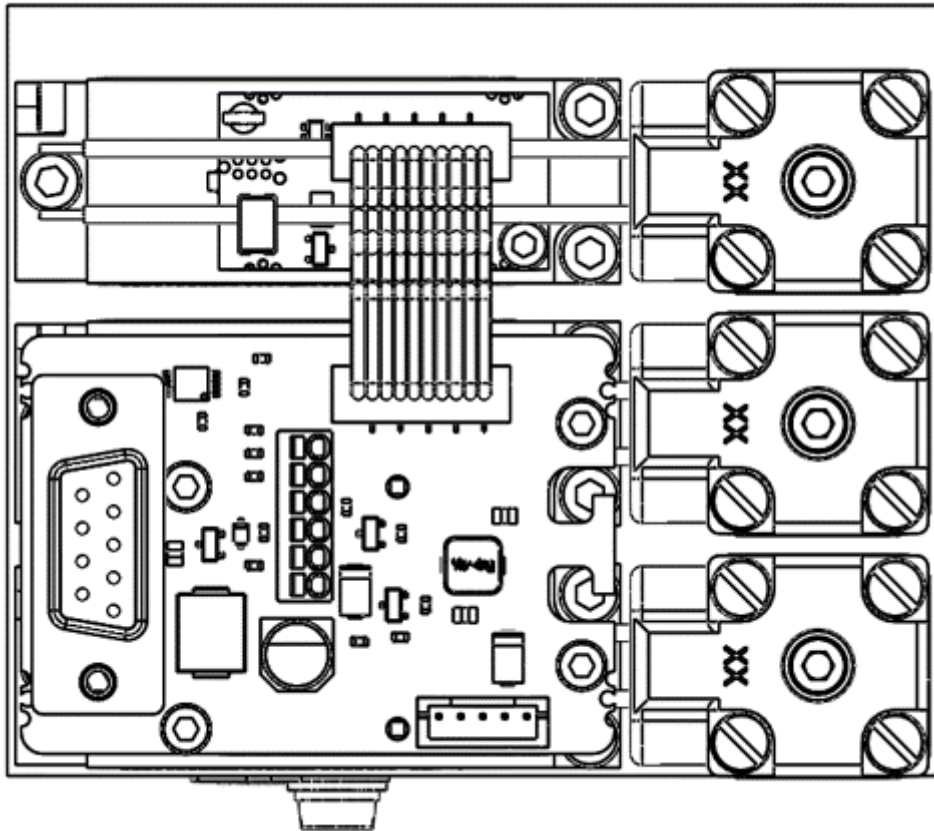

Assignment

D-Sub plug, 9-pin	Pin	Assignment
	1	Not connected
	2	GND
	3	24 V
	4	Not connected
	5	Not connected
	6	RS-485-Y, half-duplex: bridge with Pin 9
	7	RS-485-Z, half-duplex: bridge with Pin 8
	8	RS-485-B
	9	RS-485-A
JST plug connector, 5-pin	Pin	Assignment
	1	24 V
	2	CAN_H
	3	Shielding
	4	CAN_L
	5	GND

DTS 1000444910 EN Version: H Status: RL (released | freigegeben | valide) printed: 20.05.2026

6. Product operation

6.1. Measurement principle

The measured values are recorded in a secondary channel. A laminar flow element in the main channel creates a slight pressure drop. A part of the gas flow is thereby directed into the secondary channel. The sensor located there records the mass flow as a temperature difference. The measurement is performed in a specially shaped flow channel whose wall contains a silicon chip with an etched membrane. A heating resistor and 2 temperature sensors, one upstream and one downstream, are attached on this membrane. If the heating resistor is fed with a constant voltage, the differential voltage of the temperature sensors indicates the flow rate of the gas flowing over the chip.

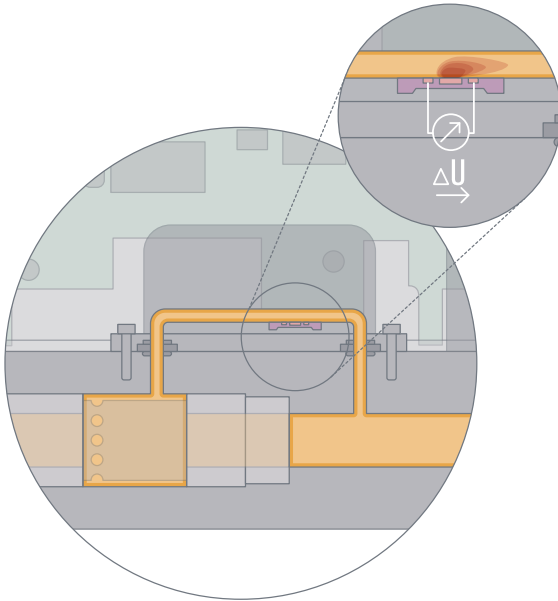

7. Product accessories

7.1. Bürkert Communicator Software

Note:

The corresponding communication software can be downloaded from the website [Type 8920](#) ▶.

The Bürkert Communicator is the most important software component of the EDIP (Efficient Device Integration Platform). Various features of this universal tool simplify the configuration and parametrisation of devices equipped with a digital CANopen-based interface. With this tool, the user has a complete overview of cyclic process values as well as acyclic diagnostic data. The integrated graphical programming environment enables the creation of decentralised sub-system control functions. The connection to the PC is established with a USB-büs interface set. The adapter is available as an accessory (see [“8.4. Ordering chart accessories” on page 10](#)).

The Bürkert Communicator enables:

- Configuration, parametrisation and diagnosis of EDIP devices / networks
- Switching between defined gases
- Easy and comfortable mapping of cyclic values
- Graphic display, monitoring and storage of process values
- Firmware update of the connected EDIP devices
- Saving and restoring device configurations
- Zero-point adjustment in case of changed ambient conditions
- Guided re-calibration routine

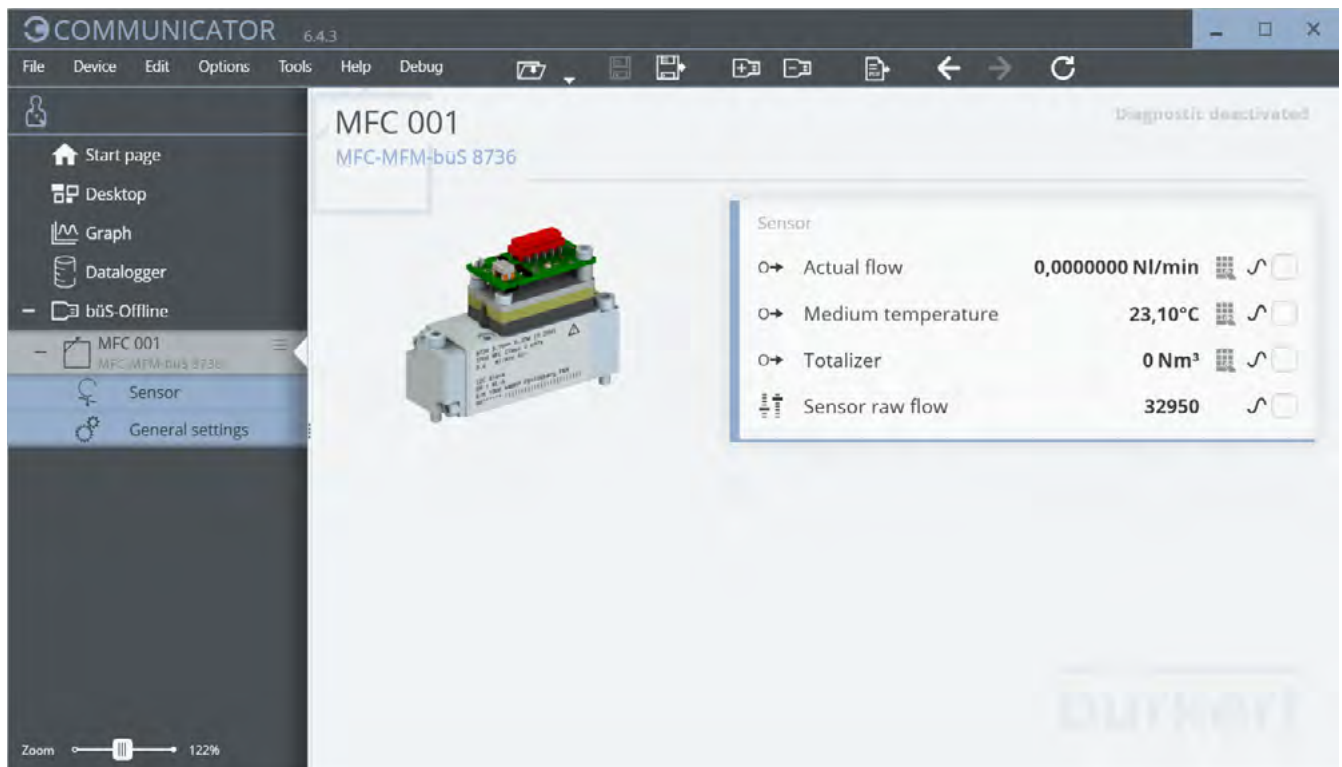

8. Ordering information

8.1. Bürkert eShop



Bürkert eShop – Easy ordering and quick delivery

You want to find your desired Bürkert product or spare part quickly and order directly? Our online shop is available for you 24/7. Sign up and enjoy all the benefits.

[Order online now](#)

8.2. Bürkert product filter



Bürkert product filter – Get quickly to the right product

You want to select products comfortably based on your technical requirements? Use the Bürkert product filter and find suitable articles for your application quickly and easily.

[Try out our product filter](#)

8.3. Bürkert Product Enquiry Form

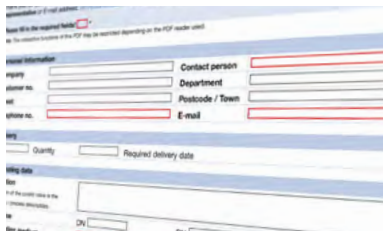

Bürkert Product Enquiry Form – Your enquiry quickly and compactly

Would you like to make a specific product enquiry based on your technical requirements? Use our Product Enquiry Form for this purpose. There you will find all the relevant information for your Bürkert contact. This will enable us to provide you with the best possible advice.

[Fill out the form now](#)

8.4. Ordering chart accessories

Description	Article number.
General accessories	
USB-büS interface set 1 (Type 8923) for connection to the Bürkert Communicator software: includes connection cable (M12 and micro USB), stick with integrated terminating resistor, power supply and software	772426
USB-büS interface set 2 (Type 8923) for connection to the Bürkert Communicator software: includes büS stick, connection cable to M12 plug, M12 connection cable on micro USB for the büS service interface and Y-distributor, cable length: 0.7 m	772551
M12 adapter cable to JST, 5-pin	696400
M12 adapter cable to CANopen clamp, 5-pin	584765
D-sub adapter cable, on strand, cable length: 5 m	580882
Connection cable D-Sub 9 to stranded wires, 10 m	580883
Device description files for software interfaces	Download from Type 8735
Bürkert Communicator software	Download from Type 8920

DTS 1000444910 EN Version: H Status: RL (released | freigegeben | valide) printed: 20.05.2026