



Mass flowmeter for gases (MFM)

- Nominal flow ranges from 0.010 l/min to 80 l/min
- High accuracy
- Very fast response times
- Digital communication via RS485
- Compact variant

Product variants described in the data sheet may differ from the product presentation and description.

Can be combined with

	Type 6013 Plunger valve 2/2-way direct-acting	▶
	Type 0330 Direct-acting 2/2 or 3/2-way pivoted armature valve	▶
	Type 8611 eCONTROL – Universal controller	▶
	Type 8619 multiCELL - multi-channel/multi-function transmitter/controller	▶
	Type 6027 Direct-acting 2/2-way plunger valve	▶
	Type BUPLUS Service, Maintenance and Commissioning	▶

Type description

The mass flow meter (MFM) Type 8703 is suited for measuring the mass flow of gases over a big flow range. The thermal MEMS sensor is located directly in the gas stream and therefore reaches very fast response times. Type 8703 can optionally be calibrated for two different gases; the user can switch between these two gases. The communication with master devices is fully digital, therefore no further analog/digital conversions are needed.

DTS 1000085464 EN Version: L Status: PO (Phase out) | Phase out | printed: 18.12.2024

Table of contents

1. General technical data	3
<hr/>	
2. Approvals and conformities	4
2.1. General notes	4
2.2. Conformity	4
2.3. Standards	4
2.4. North America (USA/Canada)	4
2.5. Foods and beverages/Hygiene	4
2.6. Oxygen	4
<hr/>	
3. Materials	5
3.1. Bürkert resistApp	5
<hr/>	
4. Dimensions	5
4.1. Threaded variant	5
4.2. Sub-base variant	6
<hr/>	
5. Device/Process connections	7
<hr/>	
6. Performance specifications	7
6.1. Pressure loss diagram (MFM)	7
<hr/>	
7. Product operation	8
7.1. Measuring principle	8
7.2. Flow characteristic	8
Nominal flow range of typical gases	8
7.3. Networking	9
<hr/>	
8. Ordering information	9
8.1. Bürkert eShop	9
8.2. Recommendation regarding product selection	9
8.3. Bürkert product filter	9
8.4. Ordering chart accessories	10

Phase out

DTS 1000085464 EN Version: L Status: PO (Phase out) | Phase out | Phase out | printed: 18.12.2024

1. General technical data

Product properties	
Dimensions	Further information can be found in chapter "4. Dimensions" on page 5.
Material	
Seal	FKM, EPDM
Housing	Stainless steel sheet 1.4301
Base block	Aluminium or stainless steel 1.4305
Total weight	Approx. 500 g (aluminium)
LED display	Status indication: 1. Power 2. Limit 3. Error
Performance data	
Nominal flow range (Q_N) ¹⁾	10 ml/min...80 l/min regarding N_2 ²⁾ Further information can be found in chapter "7.2. Flow characteristic" on page 8.
Operating pressure ³⁾	Max. 10 bar (145 psi) (depending on the nominal diameter of the proportional valve)
Measuring accuracy	± 0.8 % of reading ± 0.3 % FS (under calibration conditions and after 1 min warm-up time to achieve best measurement results)
Repeatability	± 0.1 % FS
Measuring span	1:50 (higher measuring span on request)
Response time ($t_{95\%}$)	< 300 ms
Electrical data	
Operating voltage	24 V DC
Power consumption	Max. 5 W
Residual ripple	< 2 %
Voltage tolerance	± 10 %
Electrical connection	D-Sub plug, 9-pin
Medium data	
Operating medium	Neutral, pure gases (others on request)
Calibration medium	Operating gas or air (with conversion factor)
Medium temperature	- 10 °C...+ 70 °C (- 10 °C...+ 60 °C for oxygen)
Process/Port connection & communication	
Digital outputs	1 relay output: 1. Limit (desired value cannot be reached) Loading capacity: max. 25 V, 1 A, 25 VA
Digital inputs	1 digital input: 1. Not connected
Digital communication interface	Digitally via RS485 (half-duplex or full duplex), RS422 Fieldbus option: PROFIBUS DPV1, CANopen
Port connection	NPT 1/4, G 1/4, screw-in fitting or sub-base (others on request)
Approvals and conformities	
Protection class	IP40
Environment and installation	
Installation position	Horizontal or vertical
Ambient temperature	- 10 °C...+ 50 °C
Accessories	
Software	Mass Flow Communicator

1.) The nominal flow value is the maximum flow value calibrated which can be measured. The nominal flow range defines the range of nominal flow rates (full scale values) possible.

2.) Index N: flow rates refer to 1.013 bar abs and 0 °C. Alternatively there is an Index S available which refers to 1.013 bar abs and + 20 °C.

3.) Overpressure to atmospheric pressure)

2. Approvals and conformities

2.1. General notes

- The approvals and conformities listed below must be stated when making enquiries. This is the only way to ensure that the product complies with all required specifications.
- Not all available variants can be supplied with the below mentioned approvals or conformities.

2.2. Conformity

In accordance with the Declaration of Conformity, the product is compliant with the EU Directives.

2.3. Standards

The applied standards which are used to demonstrate compliance with the EU Directives are listed in the EU-Type Examination Certificate and/or the EU Declaration of Conformity.

2.4. North America (USA/Canada)

Approval	Description
	Optional: UL Listed for the USA and Canada The products are UL Listed for the USA and Canada according to: <ul style="list-style-type: none"> • UL 61010-1 (ELECTRICAL EQUIPMENT FOR MEASUREMENT, CONTROL, AND LABORATORY USE – Part 1: General Requirements) • CAN/CSA-C22.2 No. 61010-1

2.5. Foods and beverages/Hygiene

Conformity	Description
FDA	FDA – Code of Federal Regulations (valid for variable code PL02, PL03) All wetted materials are compliant with the Code of Federal Regulations published by the FDA (Food and Drug Administration, USA) according to the manufacturer's declaration.
USP	United States Pharmacopeial Convention (USP) (valid for variable code PL04) All wetted materials are biocompatible according to the manufacturer's declaration.
	EC Regulation 1935/2004 of the European Parliament and of the Council (valid for variable code PL01, PL02) All wetted materials are compliant with EC Regulation 1935/2004/EC according to the manufacturer's declaration.

2.6. Oxygen

Conformity	Description
	Optional: Suitability for oxygen (valid for the variable code NL02) The products are suitable for use with gaseous oxygen, according to the manufacturer's declaration.

3. Materials

3.1. Bürkert resistApp

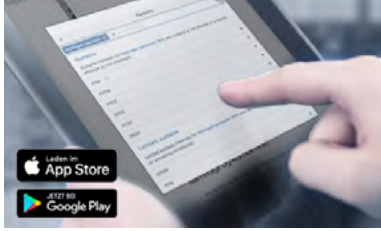

Bürkert resistApp – Chemical resistance chart

You want to ensure the reliability and durability of the materials in your individual application case? Verify your combination of media and materials on our website or in our resistApp.

[Start chemical resistance check](#)

4. Dimensions

4.1. Threaded variant

Note:

Dimensions in mm

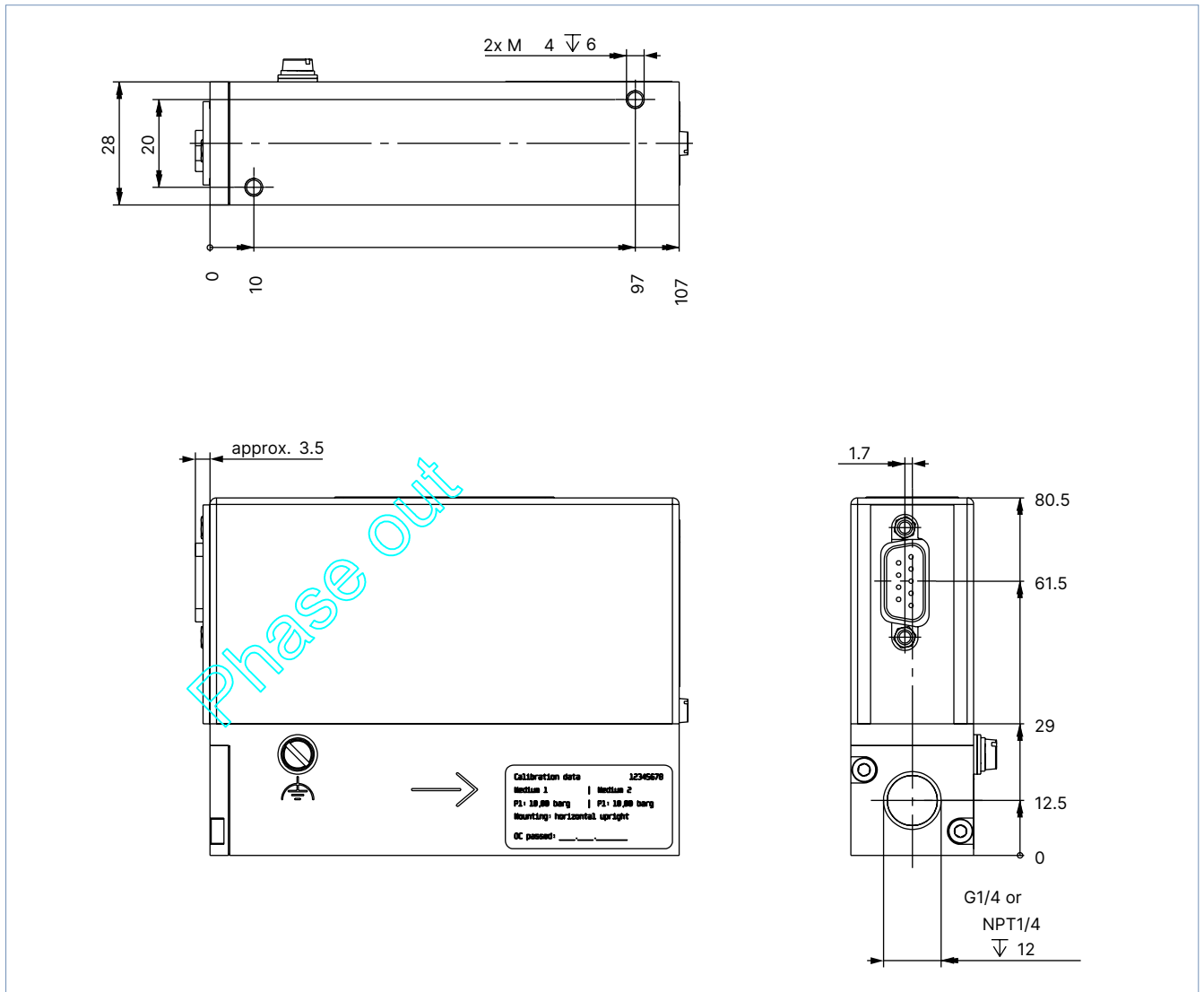

DTS 1000085464 EN Version: L Status: PO (Phase out) | Phase out | Phase out | printed: 18.12.2024

4.2. Sub-base variant

Note:

Dimensions in mm

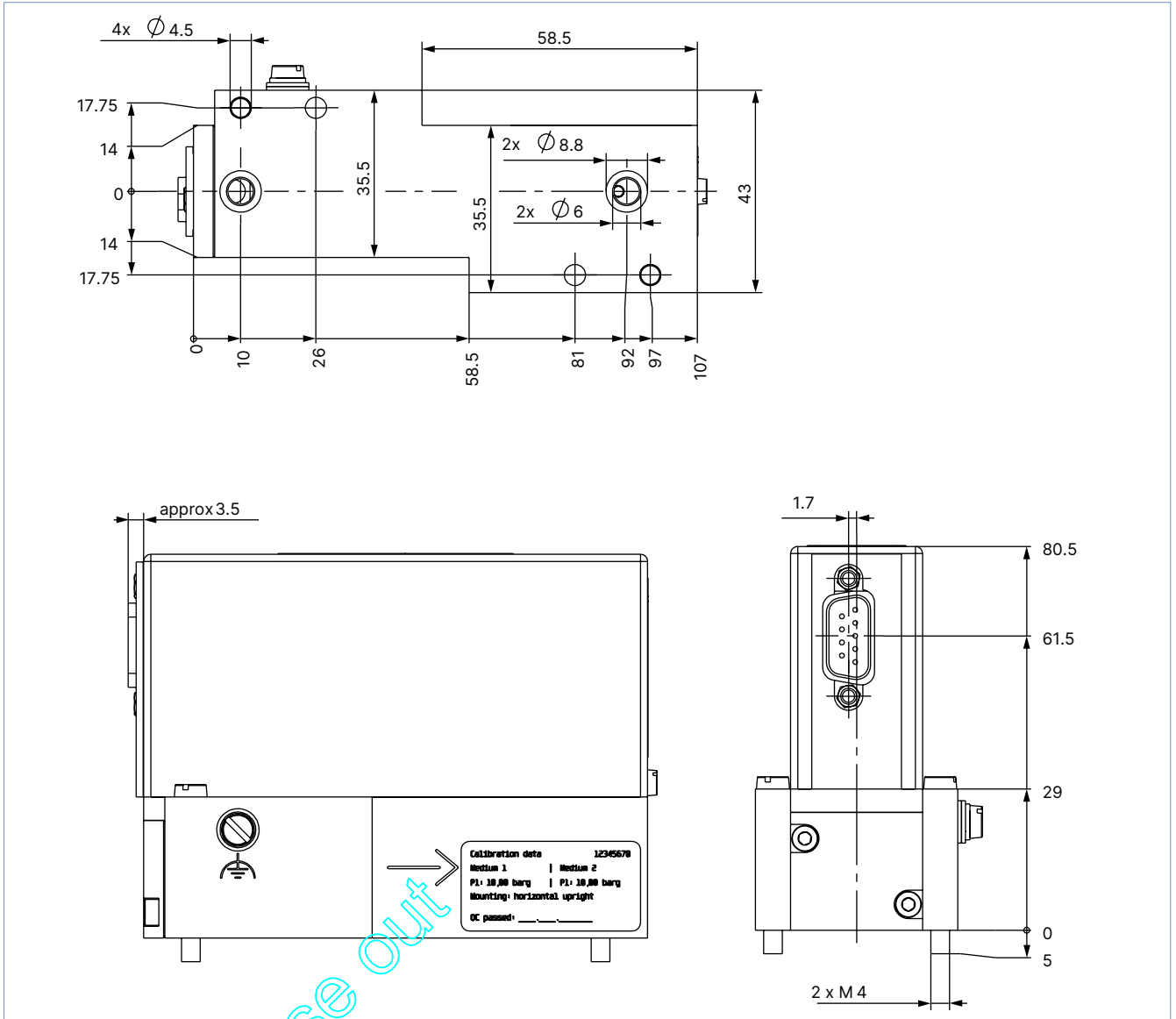

DTS 1000085464 EN Version: L Status: PO (Phase out) | Phase out | Phase out | printed: 18.12.2024

Phase Out

5. Device/Process connections

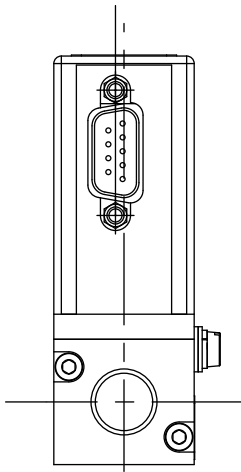

Plug D-Sub, 15-pin	Pin	Assignment
Analogue control unit		
	1	Binary input (related to GND Pin2)
	2	GND
	3	Power supply + 24 V DC
	4	Relay - normally open contact
	5	Relay - normally closed contact
	6	TX+ (RS485-Y) – bridge with pin 9 at half duplex
	7	TX- (RS485-Z) – bridge with pin 8 at half duplex
	8	RX- (RS485-B)
	9	RX+ (RS485-A)

1.) RS232 communication is only possible when using an RS232 adapter, see "8.4. Ordering chart accessories" on page 10.

6. Performance specifications

6.1. Pressure loss diagram (MFM)

The diagram shows an example of the pressure loss curves for air flow. To determine the pressure loss of another gas, it must first be converted to the corresponding air flow rate and the fluidics used for the other gas must be taken into account.

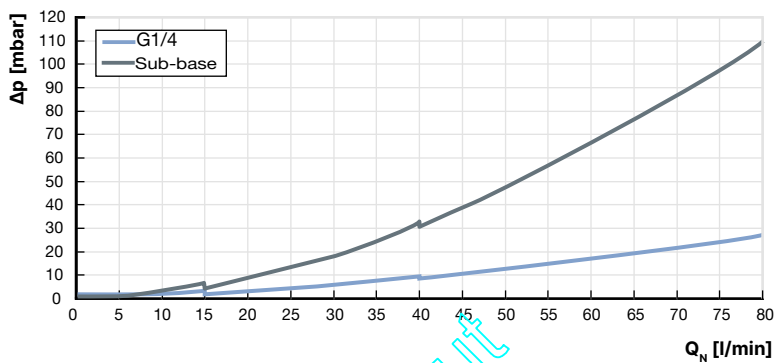

Phase out

7. Product operation

7.1. Measuring principle

Measurement takes place via bypass. A laminar flow element (LFE) in the main channel creates a low pressure drop. A part of the gas flow is thereby directed into a side channel. A sensor measures the mass flow as temperature difference. The measurement is performed in a specially shaped flow channel whose wall contains a Si chip with an etched membrane. A heating resistor and 2 temperature sensors, one upstream and one downstream, are placed on this membrane. If the heating resistor is fed with a constant voltage, the differential voltage of the temperature sensors indicate the gas flow over the chip.

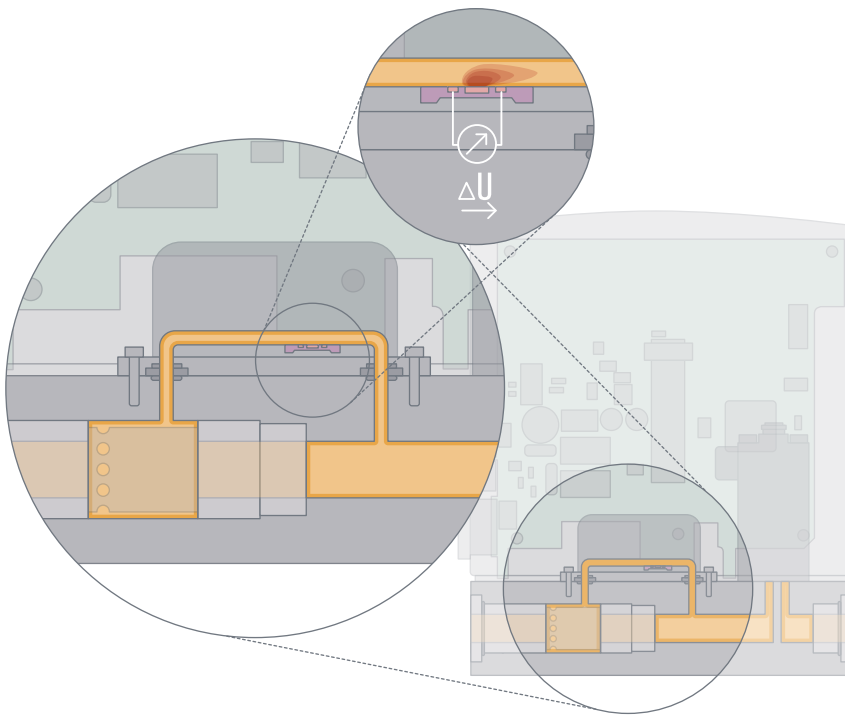

7.2. Flow characteristic

Nominal flow range of typical gases

Note:

- $Q(\text{Gas}) = f \times Q(\text{N}_2)$
- When using the gas factors, measurement errors may occur that are outside the data sheet specification. For applications requiring high accuracy, calibration under field conditions is recommended.
- Furthermore, the media compatibility of the sealing materials of the MFM should be checked before use with another gas.

Gas	Min. Q_N [l/min]	Max. Q_N [l/min]
Argon	0.01	80
Helium	0.01	500
Carbon dioxide	0.02	40
Air	0.01	80
Methane	0.01	80
Oxygen	0.01	80
Nitrogen	0.01	80
Hydrogen	0.01	500

DTS 1000085464 EN Version: L Status: PO (Phase out) | Phase out | Phase out | printed: 18.12.2024

7.3. Networking

Note:

To install the software, click [here](#) ▶.

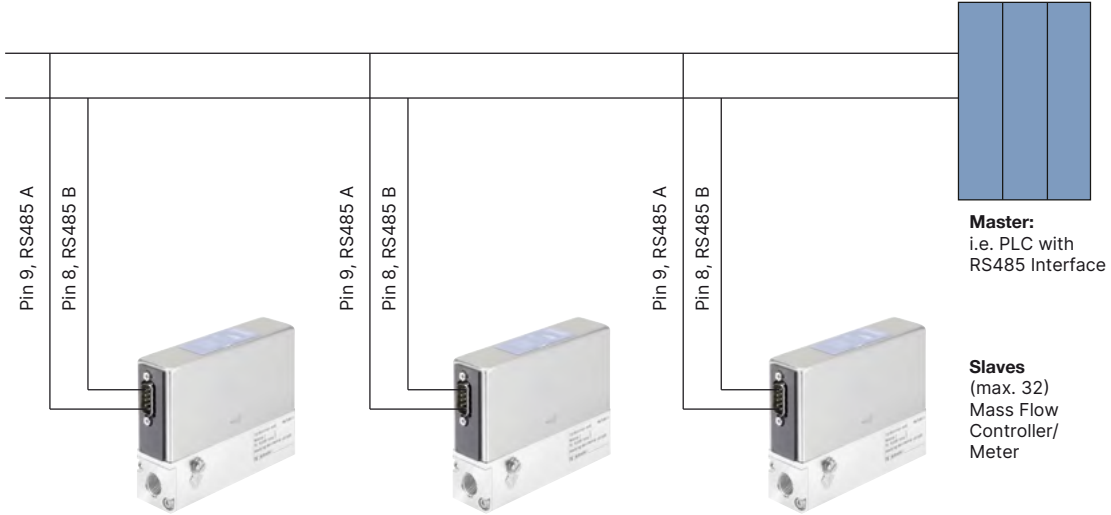

8. Ordering information

8.1. Bürkert eShop



Bürkert eShop – Easy ordering and quick delivery

You want to find your desired Bürkert product or spare part quickly and order directly? Our online shop is available for you 24/7. Sign up and enjoy all the benefits.

[Order online now](#)

8.2. Recommendation regarding product selection

Note:

Contact your Bürkert branch for device design.

The media compatibility, the maximum inlet pressure and the correct selection of the flow measuring span are decisive for the proper function of an MFM within the application. The pressure loss across the MFM depends on the nominal flow rate and operating pressure.

8.3. Bürkert product filter



Bürkert product filter – Get quickly to the right product



You want to select products comfortably based on your technical requirements? Use the Bürkert product filter and find suitable articles for your application quickly and easily.

[Try out our product filter](#)

8.4. Ordering chart accessories

Note:

The adapters serve mainly for initial operation or diagnosis. Those are not obligatory for continuous operation.

Description	Article no.
Connections/cables	
D-Sub socket, 15-pin, soldered connection	917623 
Adapter accessories	
USB adapter	670693 
USB connection cable, cable length: 2 m	772299 

Phase out