



Control head for decentralised automation of ELEMENT process valves

- Contact-free inductive valve position registration (Teach function)
- Colour illuminated status display
- Integrated pilot air duct in the actuator
- AS-Interface, IO-Link, Bürkert system bus (büS)
- With ATEX II cat. 3G/D approval

Product variants described in the data sheet may differ from the product presentation and description.

Can be combined with

	Type 2100 Pneumatically operated 2/2-way angle seat valve ELEMENT for decentralized automation	▶
	Type 2101 Pneumatically operated 2/2-way globe valve ELEMENT for decentralised automation	▶
	Type 2103 2/2-way diaphragm valve with pneumatic stainless steel actuator (Type ELEMENT) for decentralised automation	▶
	Type 2104 T-diaphragm valve with pneumatic actuator in stainless steel (Type ELEMENT) for decentralised automation	▶
	Type 2105 Tank bottom diaphragm valve with pneumatic actuator in stainless steel (Type ELEMENT) for decentralised automation	▶
	Type 2106 Pneumatically operated 3/2-way seat valve ELEMENT for decentralized automation	▶

Type description

The device key 8695 control head is designed for decentralised automation of ELEMENT Type 21xx pneumatic process valves with smaller nominal diameters. The valve position is registered via contact-free, analogue sensor element which automatically detects and saves the valve end position via the Teach function during start-up. The integrated pilot valve controls single or double-acting actuators.

The design of the control head and actuator is specially configured for the requirements of hygienic process environments and enables internal pilot air duct routing without external piping. In addition to the electrical position feedback, the device status is shown directly on the control head itself via coloured LEDs. An optional AS-Interface communication interface can be selected.

The housing is easy to clean and features proven IP protection and chemically resistant materials for use in hygienic processing in the food, beverage and pharmaceutical industries.

Combined with Bürkert ELEMENT actuators, the pneumatic actuating system enables spring chamber aeration that avoids actuator chamber contamination from the environment.

Table of contents

1. General technical data	3
1.1. Control head Type 8695	3
1.2. Without fieldbus communication: 24 V DC	4
1.3. With fieldbus communication: AS-Interface	5
1.4. With digital communication: IO-Link	5
1.5. With digital communication: Bürkert system bus (bÜS).....	5
2. Approvals and conformities	6
2.1. General notes	6
2.2. Conformity	6
2.3. Standards.....	6
2.4. Explosion protection.....	6
2.5. North America (USA/Canada)	6
2.6. Others	6
China Compulsory Certification (CCC).....	6
3. Materials	7
3.1. Material specifications	7
4. Dimensions	7
4.1. Mounting on process valve ELEMENT Type 21xx.....	7
5. Device/Process connections	8
5.1. Electrical connections	8
Without fieldbus communication 24 V DC	8
AS-Interface connection	8
IO-Link connection	8
Bürkert system bus (bÜS) connection	9
6. Product installation	10
6.1. Combination options with pneumatic ELEMENT process valves	10
7. Ordering information	11
7.1. Bürkert eShop	11
7.2. Bürkert product filter	11
7.3. Ordering chart	11
Control head for decentralized automation of ELEMENT On/Off process valves Type 21xx	11
7.4. Ordering chart Accessories	12
Standard accessories	12
Adapter kits.....	12

DTS 1000110880 EN Version: Y Status: RL (released | freigegeben | validé) printed: 09.01.2025

1. General technical data

1.1. Control head Type 8695

Product properties	
Dimensions	Further information can be found in chapter "4. Dimensions" on page 7.
Material	
Body	PPS, stainless steel
Seal	EPDM
Cover	PC
Operation	
Operating keys	2
Service interface	Connected to PC via USB connection
Configuration tool	Bürkert Communicator
Commissioning	
Setting valve end position	Automatically via teach function or manually (for device version without pilot valve)
Manual operation pilot valve	Yes
Status display	
Display of device and valve status	Multicoloured LEDs
Communication	
Fieldbus	AS-Interface
Digital	IO-Link, Bürkert system bus (büS) (based on CANopen)
Performance data	
Position sensor	
Analogue position sensor	Inductive (contactless) with self-adjusting switching points (PNP) (NPN on request)
Stroke range for linear actuator	
Valve spindle	2.5...32 mm
Electrical data	
Electrical connection	
Multipole version	Circular plug M12
Pneumatic data	
Control medium	Neutral gases, air, quality class according to ISO 8573 - 1
Dust content	Class 7 (< 40 µm particle size)
Particle density	Class 5 (< 10 mg/m ³)
Pressure dew point	Class 3 (← 20 °C)
Oil content	Class X (< 25 mg/m ³)
Supply pressure	0...7 bar ¹⁾
Pilot air port	Threaded connection G 1/8, stainless steel
Actuating system	
Circuit function	Single and double-acting
Air capacity	7 l _N /min (for aeration and ventilation) (Q _{Nr} value according to definition at pressure drop from 7 to 6 bar abs)
Actuator series/size	Type 21xx, actuator Ø 50 mm

Approvals and conformities

Explosion protection

Ignition protection class	II 3D Ex tc IIIC T135 °C Dc II 3G Ex ec IIC T4 Gc
ATEX	BVS 14 ATEX E 008 X II 3D Ex tc IIIC T135 °C Dc II 3G Ex ec IIC T4 Gc
IECEX	IECEX BVS 14.0009 X Ex tc IIIC T135 °C Dc Ex ec IIC T4 Gc

Further information can be found in chapter [“2.4. Explosion protection” on page 6.](#)

North America (USA/Canada)

UL Listed for the USA and Canada	cULus certificate: E238179 Further information can be found in chapter “2.5. North America (USA/Canada)” on page 6.
FM Explosion Protection	Increased Safety for Class I, Zone 2, AEx ec IIC T4 Gc hazardous (classified) locations, indoors and outdoors (IP54). Alternatively marked as Class I Division 2 Groups A, B, C, and D; T4. Further information can be found in chapter “2.5. North America (USA/Canada)” on page 6.

Others

China Compulsory Certification (CCC)	The products with Ex approval are suitable for import and use for hazardous applications in China. Further information can be found in chapter “2.6. Others” on page 6.
--------------------------------------	---

Further information can be found in chapter [“2. Approvals and conformities” on page 6.](#)

Environment and installation

Operating conditions

Ambient temperature

With pilot valve	- 10...+ 55 °C
Without pilot valve	- 20...+ 60 °C
Degree of protection	IP65/IP67 according to EN 60529, 4X according to NEMA 250 Standard
Operating altitude	Up to 2000 m above sea level

Installation and mechanical data

Installation variant	Direct mounting
Installation position	As required, preferably with actuator in upright position
Valve actuator (type, size)	ELEMENT actuator series Type 21xx, actuator size 50 mm and third-party actuators
Adapter kit	Further information can be found in chapter “Adapter kits” on page 12.

1.) The supply pressure must be 0.5...1 bar above the minimum required pilot pressure of the valve actuator.

1.2. Without fieldbus communication: 24 V DC

Electrical data

Operating voltage	24 V DC ± 25 % UL: NEC Class 2
Residual ripple with DC	10 %
Power consumption	2 W or 5 W at maximum load on one active digital output
Protection class	III according to DIN EN 61140

Electrical connection

Multipole	M12, 8-pin
Outputs	Max. 100 mA per output

1.3. With fieldbus communication: AS-Interface

Product properties	
Profile	S-B.A.E. (AB Slave, max. 62 slaves/master), certificate No. 136801 according to specification v3.0
Electrical data	
Operating voltage	Via ASi power supply 29.5...1.6 V DC (according to specification), UL: NEC Class 2
Power consumption	
Current consumption	Max. 110 mA with pilot valves
Electrical connection	M12, 4-pin
Outputs	
Switching capacity pilot valve	Approx. 0.8 W
Watchdog function	Integrated
Programming data	See operating instructions Type 8695 ▶

1.4. With digital communication: IO-Link

Electrical data	
Electrical connection	M12 × 1, 5-pin, A-coded
IO-Link revision	1.1
SIO mode	No
VendorID	0×0078, 120
DeviceID	See IODD file (the IODD file can be downloaded from our website Type 8695 ▶, see Software > Device Description Files)
Transmission rate	230.4 kbit/s (COM 3)
Data storage	Yes
Cable length	Max. 20 m
Port class	A and B
Power supply	Via IO-Link
Port Class A	
Operating voltage	24 V DC ± 25 % (according to specification)
Current consumption	Max. 150 mA with pilot valve Max. 100 mA without pilot valve
Port Class B	
Operating voltage	
System supply (Pin 1 + 3)	24 V DC ± 25 % (according to specification)
Actuator supply (Pin 2 + 5)	24 V DC ± 25 % (according to specification)
Current consumption	
System supply (Pin 1 + 3)	Max. 100 mA
Actuator supply (Pin 2 + 5)	Max. 50 mA

1.5. With digital communication: Bürkert system bus (büS)

Electrical data	
Operating voltage	18...30 V DC (according to specification)
Electrical connection	M12 × 1, 5-pin, A-coded
Current consumption	Max. 150 mA

2. Approvals and conformities

2.1. General notes

- The approvals and conformities listed below must be stated when making enquiries. This is the only way to ensure that the product complies with all required specifications.
- Not all available versions can be supplied with the below mentioned approvals or conformities.



2.2. Conformity

In accordance with the Declaration of Conformity, the product is compliant with the EU Directives.



2.3. Standards

The applied standards which are used to demonstrate compliance with the EU Directives are listed in the EU-Type Examination Certificate and/or the EU Declaration of Conformity.

2.4. Explosion protection

Approval	Description
 	Optional: Explosion protection ATEX: BVS ATEX E 008 X II 3D Ex tc IIIC T135 °C Dc II 3G Ex ec IIC T4 Gc IECEX: IECEX BVS 14.0009 X Ex tc IIIC T135 °C Dc Ex ec IIC T4 Gc

2.5. North America (USA/Canada)

Approval	Description
	Optional: UL Listed for the USA and Canada The products are UL Listed for the USA and Canada according to: <ul style="list-style-type: none"> • UL 61010-1 (ELECTRICAL EQUIPMENT FOR MEASUREMENT, CONTROL, AND LABORATORY USE – Part 1: General Requirements) • CAN/CSA-C22.2 No. 61010-1
	Optional: FM (Factory Mutual) – Explosion Protection Increased Safety for Class I, Zone 2, AEx ec IIC T4 Gc hazardous (classified) locations, indoors and outdoors (IP54). Alternatively marked as Class I Division 2 Groups A, B, C, and D; T4.

2.6. Others

China Compulsory Certification (CCC)

Conformity	Description
	Optional: China Compulsory Certification (CCC) The products with Ex approval are suitable for import and use for hazardous applications in China.

3. Materials

3.1. Material specifications

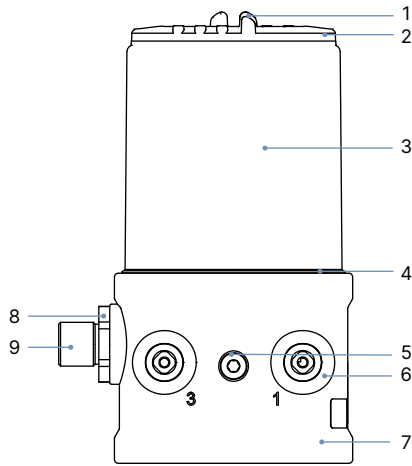

No.	Element	Material
1	Cover	PC
2	Seal	EPDM
3	Body casing	Stainless steel
4	Seal	EPDM
5	Screws	Stainless steel
6	Push-in connector Threaded ports G 1/8	POM/stainless steel Stainless steel
7	Basic housing	PPS
8	Screws	Stainless steel
9	M12 plug connector	Stainless steel

4. Dimensions

4.1. Mounting on process valve ELEMENT Type 21xx

Note:

Dimensions in mm

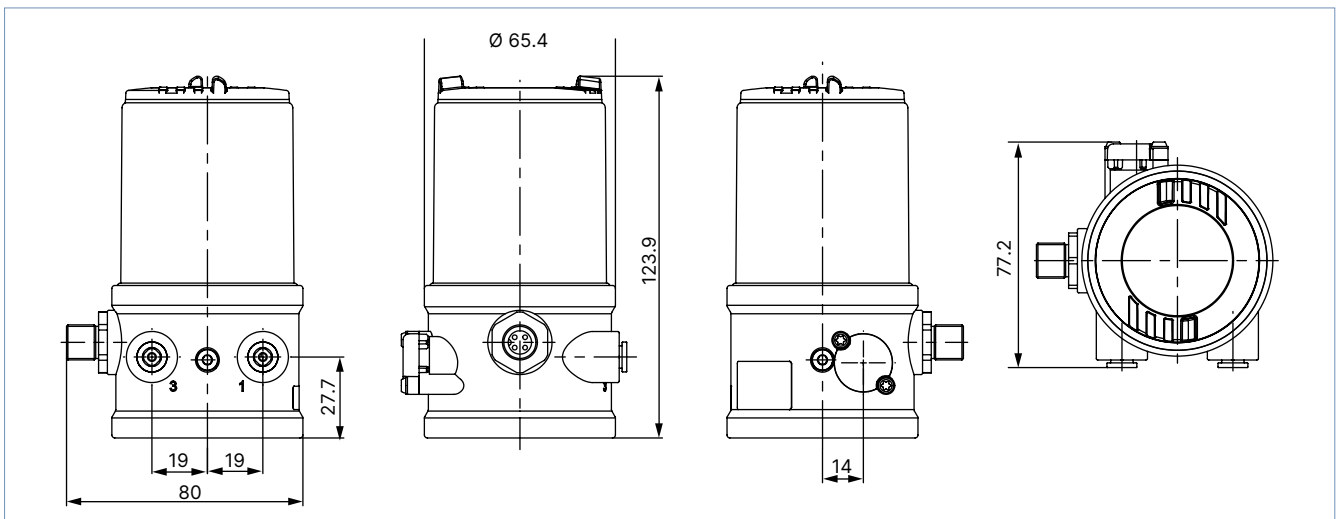

DTS 1000110880 EN Version: Y Status: RL (released | freigegeben | validé) printed: 09.01.2025

5. Device/Process connections

5.1. Electrical connections

Without fieldbus communication 24 V DC

M12 circular plug, 8-pin		Pin	Description	Pin assignment
	1	Digital output End position with drive activated	DO2+	
	2	Digital output End position deactivated for actuator	DO1+	
	3	Operating voltage GND	GND	
	4	Operating voltage +	24 V DC	
	5	Digital input valve control +	Valve +	
	6	Digital input valve control -	Valve -	
	7	-	Not assigned	
	8	-	Not assigned	

AS-Interface connection

M12 circular plug, 4-pin		Pin	Description	Pin assignment
	1	Bus +	Bus cable AS-Interface +	
	2	NC	Not assigned	
	3	Bus -	Bus cable AS-Interface -	
	4	NC	Not assigned	

IO-Link connection

M12 circular plug, 5-pin, Port Class A		Pin	Description	Pin assignment
	1	L +	24 V DC	System supply
	2	I/Q	N.C.	Not connected
	3	L -	0 V (GND)	System supply
	4	C/Q	IO-Link	Communication
	5	N.C.	N.C.	Not connected

M12 circular plug, 5-pin, Port Class B		Pin	Description	Pin assignment
	1	L +	24 V DC	System supply
	2	P24	24 V DC	Actuator supply
	3	L -	0 V (GND)	System supply
	4	C/Q	IO-Link	Communication
	5	N24	0 V (GND)	Actuator supply

DTS 1000110880 EN Version: Y Status: RL (released | freigegeben | validé) printed: 09.01.2025

Bürkert system bus (büS) connection

M12 circular plug, 5-pin		Pin	Description	Cable colour
		1	CAN shielding	CAN shielding
		2	+ 24 V DC \pm 25 %, maximum residual ripple 10 %	Red
		3	GND / CAN_GND	Black
		4	CAN_H	White
		5	CAN_L	Blue

6. Product installation

6.1. Combination options with pneumatic ELEMENT process valves

Note:

A decentralised, **automated valve system** consists of a **control head Type 8695** and an **ELEMENT process valve Type 21xx**, actuator size 50 mm.

The following information is required to select a complete system:

- **Article no.** of the desired **control head**, see **data sheet Type 8695**
- **Article no.** of the desired **process valve Type 21xx**, see **data sheet Type 2100 ▶, Type 2101 ▶, Type 2103 ▶**

You order two components and receive a completely assembled and certified valve.

Example of decentralised automation of On/Off ELEMENT valve systems



1.) See data sheet **adaptations for third-party actuators Type KK01 ▶** or contact the appropriate Bürkert sales office.

DTS 1000110880 EN Version: Y Status: RL (released | freigegeben | validé) printed: 09.01.2025

7. Ordering information

7.1. Bürkert eShop



Bürkert eShop – Easy ordering and quick delivery

You want to find your desired Bürkert product or spare part quickly and order directly? Our online shop is available for you 24/7. Sign up and enjoy all the benefits.

[Order online now](#)

7.2. Bürkert product filter



Bürkert product filter – Get quickly to the right product

You want to select products comfortably based on your technical requirements? Use the Bürkert product filter and find suitable articles for your application quickly and easily.

[Try out our product filter](#)

7.3. Ordering chart

Control head for decentralized automation of ELEMENT On/Off process valves Type 21xx

Note:

- The adapter kits must be ordered separately, see ["Adapter kits" on page 12.](#)
- All standard versions are UL-approved.
- ATEX/IECEX for IO-Link and büS is in preparation.
- Feedback version of IO-Link is in preparation.
- Other versions are available on request.

Electrical Connection	Communication	Control function pilot valve system	Pilot air ports threaded connection	Article no.	
				Standard	ATEX II Cat. 3G/D, IECEX, CCC ¹⁾
M12 plug connector	IO-Link Port Class A	Single-acting	G 1/8	20032480	20032484
		Double-acting	G 1/8	20032478	20032482
		Without	G 1/8	20036715	In preparation
	IO-Link Port Class B	Single-acting	G 1/8	20036719	In preparation
		Double-acting	G 1/8	20036717	In preparation
		Without	G 1/8	20036709	In preparation
	büS	Single-acting	G 1/8	20036713	In preparation
		Double-acting	G 1/8	20036711	In preparation
		Without	G 1/8	20036709	In preparation
	AS-Interface S-B.A.E	Single-acting	G 1/8	20024711	20024718
		Double-acting	G 1/8	20024720	20024722
	Without fieldbus communication	Single-acting	G 1/8	20036705	20037901
Double-acting		G 1/8	20036702	20037898	
Without		G 1/8	20036700	20037894	











1) CCC (China Compulsory Certificate) for device versions with Ex approval

7.4. Ordering chart Accessories

Standard accessories

Note:

Must be ordered separately.

Description	Article no.
M12 circular socket with cable, 8-pin, cable length: 5 m, for input and output signals	919267 
AS-interface flat cable clamp, M12 outlet, stainless steel outlet	799646 
Silencer G 1/8	780779 
Silencer 6 mm, PE, push-in connector	902662 
USB bÜS interface set 2 (Type 8923) for connection to the Bürkert Communicator software: including bÜS stick, connection cable to M12 plug, M12 connection cable on micro USB for the bÜS service interface and Y distributor, cable length: 0.7 m	772551 
bÜS cable extension, M12, cable length: 1 m	772404 
bÜS cable extension, M12, cable length: 3 m	772405 
bÜS cable extension, M12, cable length: 5 m	772406 
bÜS cable extension, M12, cable length: 10 m	772407 
Sensor puck (spare part)	677245 
Software Bürkert Communicator	Type 8920 

Adapter kits

Note:

Must be ordered separately.

Adapter kits for third-party actuators can be found in the [data sheet Adaptation for third-party actuators Type KK01](#)  or contact the appropriate Bürkert sales office.

Description	Actuator size	Control function	Article no.
Attachment kit for Type 21xx/23xx actuator series	Ø 50 mm	Universal	679918 