



AirLINE – the valve island optimised for process automation

- Safety-related shut-off of valves possible
- Higher plant availability with PROFINET S2 (system redundancy)
- Process reliability through pneumatic functions
- Optimised for installation at the bottom of the control cabinet
- EX-variants: ATEX / IECEx Zone 2, CCC, cURus HazLoc CL I, II, III Div 2

Product variants described in the data sheet may differ from the product presentation and description.

Can be combined with

	Type ME43 Fieldbus gateway	▶
	Type 2012 Pneumatically operated 2/2-way globe valve CLASSIC	▶
	Type 8695 Control head for decentralised automation of ELEMENT process valves	▶
	Type 8920 Bürkert Communicator	▶
	Type 8653 AirLINE Field – the valve island – optimised for process automation	▶
	Type 8614 Pneumatic control cabinet solutions for hygienic process environments	▶
	Type SV04 Spare part sets for Type 8652	▶

Type description

The valve island Type 8652 AirLINE has been especially developed for process automation requirements. New diagnostic functions can be visualised on the LC display, both in clear text as well as symbols. This makes it easy to relate to the shown messages and helps to save time during start-up and maintenance. Furthermore, the diagnostic message is also available at the controller. This, therefore, enables a fast overview of the plant status. The hardware is optimised for installation at the bottom of the control cabinet. Installation on a standard rail is, of course, also possible. Moreover, key pneumatic functions ensure increased process reliability. For instance, check valves in the exhaust air ducts make sure there is no unplanned actuation due to pressure peaks.

Table of contents

1. General technical data	3
1.1. General data	3
1.2. AirLINE Quick	5
2. Circuit functions	6
2.1. Standard functions	6
2.2. SIA variant	6
3. Approvals and conformities	7
3.1. General notes	7
3.2. Conformity	7
3.3. Standards	7
3.4. Explosion protection	7
3.5. North America (USA/Canada)	7
3.6. Others	8
China Compulsory Certification (CCC)	8
4. Dimensions	9
4.1. Variant 4-, 8- and 12-fold	9
4.2. Variant 16-, 20- and 24-fold	10
5. Device/Process connections	11
5.1. Power supply for communication and display	11
5.2. Power supply for pneumatic valves	11
5.3. Fieldbus interface	12
6. Product installation	13
6.1. Installation notes	13
Installation situation of the valve terminal inside the control cabinet	13
7. Product design and assembly	14
7.1. Product assembly	14
7.2. Electronic module with digital inputs (optional)	15
7.3. Valves Type 6534 for safety-related shut-off, SIA variant (optional)	16
7.4. Module-based safety shutdown (optional)	17
7.5. Example configuration	17
8. Product accessories	18
8.1. Bürkert Communicator Software	18
9. Ordering information	19
9.1. Bürkert eShop	19
9.2. Bürkert configurator	19
9.3. Bürkert product filter	19
9.4. Ordering chart replacement valves	20
Solenoid valve Type 6534	20
Solenoid valve Type 6534 SIA variant (2nd port for shutdown)	22
9.5. Ordering chart electronic module	23
9.6. Ordering chart connector module	23
9.7. Ordering chart plug	23
9.8. Ordering chart accessories	24
Fieldbus gateway Type ME43	24
Accessory for Software Bürkert Communicator	24

1. General technical data

1.1. General data

Product properties	
Dimensions	Further information can be found in chapter "4. Dimensions" on page 9.
Material	
Body	PA (polyamide)
Seal	NBR and PUR
Maximum installation width of a valve island	Further information can be found in chapter "4. Dimensions" on page 9.
Width per station	11 mm
Manual override	Latching, spring return (optional: lockable)
Number of valve positions	Max. 24
Maximum number of valve functions	Max. 48
Circuit functions/Operating principle ¹⁾	Further information can be found in chapter "2. Circuit functions" on page 6.
Pneumatic intermediate supply	Optional for the variants with 16, 20 and 24 valve positions
Performance data	
Pressure data	Overpressure to atmospheric pressure
Pressure range	Vac...10 bar
External supply air (auxiliary pilot air)	3...10 bar
Flow rate Q_{Nn} value air	310 l/min ¹⁾ measured at + 20 °C, 6 bar pressure bar at valve inlet and 1 bar differential pressure
Flow rate Q_{Nn} value air with integrated P shut-off	Flow reduced by approx. 10 %
Nominal operating mode	Continuous operation (100 % duty cycle)
Switching time	Measured according to ISO 12238
Electrical data	
Operating voltage	24 V DC
Voltage tolerance	± 10 %
Residual ripple (at DC)	1 Vss
Nominal power of each valve	0.7 W (0.175 W after power reduction)
Nominal current of each valve	29 mA (10 mA after power reduction)
Position feedback	Max. 48
Protection class	III according to DIN EN 61140, VDE 0140
Total current	
With fieldbus connection	Further information can be found in the operating instructions Type 8652 ▶
Medium data	
Operating medium	Oil-free or lubricated compressed dry air, neutral gases (5 µm filter recommended)
Compressed air quality	ISO 8573 - 1:2010, Class 7.4.4
Approvals and conformities	
Degree of protection	IP20, IP65 in closed control cabinets
Explosion protection	Further information can be found in chapter "3.4. Explosion protection" on page 7.
North America (USA/Canada)	Further information can be found in chapter "3.5. North America (USA/Canada)" on page 7.
Type Rating (NEMA 250, UL50/50E)	Type 4X in closed enclosures (Type 8652 with stainless steel variant)
Process/Port connection & communication	
Working port	D 6, D ¼
Air supply connection	D 10, D ⅜
Communication module	ME43
Communication interface	PROFIBUS DP Industrial Ethernet (PROFINET IO, EtherNet/IP, Modbus TCP, EtherCAT, CC-Link IE Field Basic) PROFINET S2 CANopen bùS (for networking with Bürkert devices)
Environment and installation	
Installation position	Any
Storage temperature	- 20 °C...+ 60 °C
Ambient temperature	- 10 °C...+ 55 °C

Accessories

Bürkert software ²⁾

Bürkert Communicator software

Further information can be found in chapter **“8.1. Bürkert Communicator Software”** on page **18**.

1.) The maximum flow rate depends on the valve function.

2.) For commissioning, the **Bürkert Communicator software Type 8920** ▶ as well as the associated USB büS interface set 1 with **Article no. 772426** 🛒 are required.

1.2. AirLINE Quick

AirLINE Quick considerably reduces the use of components in the control cabinet. With the AirLINE Quick Adapter, the valve terminal is adapted directly to the control cabinet floor or control cabinet wall.

Advantages:

- Reduced space requirement in the control cabinet
- This makes it possible to use more compact control cabinets
- Reduced installation effort due to hose connections directly at the bottom of the control cabinet

Product properties

Material	
AirLINE Quick Adapter Plate	Stainless steel 1.4301 Anodised aluminium
Pneumatic connections	Stainless steel 1.4401 Nickel-plated brass
Valve functions per station	8, 16, 24, 32, 40 and 48

Process/Port connection & communication

Connection	
Pneumatic Supply / Exhaust	Push-in D 10 mm, D 3/8"
Pneumatic working ports	Push-in D 6 mm, D 1/4"

Environment and installation

Installation position	Control cabinet wall Control cabinet floor
-----------------------	---

AirLINE Quick Adapter in stainless steel 1.4301 or anodised aluminium

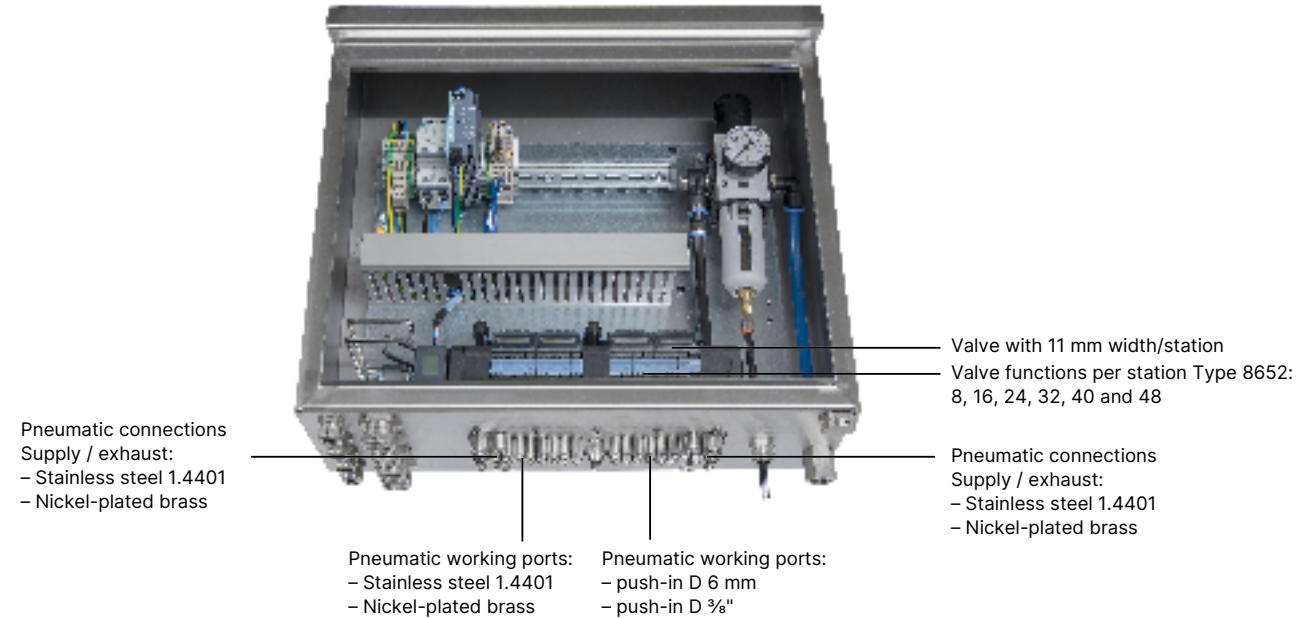

DTS 1000336890 EN Version: W Status: RL (released | freigegeben | valide) printed: 20.03.2025

2. Circuit functions

2.1. Standard functions

Symbol	Description
	Circuit function C (CF C) 3/2-way solenoid valve Servo-controlled, with manual override Normally closed
	Circuit function C (CF C) 2 x 3/2-way solenoid valve Servo-controlled, with manual override Normally closed
	Circuit function D (CF D) 2 x 3/2-way solenoid valve Servo-controlled, with manual override Normally open
	Circuit function H (CF H) 5/2-way solenoid valve Servo-controlled, with manual override Pressure applied via port (1), therefore one of the two ports (2) or (4) is under pressure.
	Circuit function L (CF L) 5/3-way solenoid valve Servo-controlled, with manual override In middle position all ports locked
	Circuit function M (CF M) 5/3-way solenoid valve Servo-controlled, with manual override In middle position ports 2 and 4 ventilated
	Circuit function N (CF N) 5/3-way solenoid valve Servo-controlled, with manual override In middle position ports 2 and 4 exhausted
	Circuit function Z (CF Z) 5/2-way solenoid valve Servo-controlled, Impulse variant with 2 coils and manual override Pressure applied via port (1), therefore one of the two ports (2) or (4) is under pressure.

2.2. SIA variant

Symbol	Description
	Circuit function C (CF C) 3/2-way solenoid valve Servo-controlled Normally closed
	Circuit function C (CF C) 2 x 3/2-way solenoid valve Servo-controlled Normally closed
	Circuit function H (CF H) 5/2-way solenoid valve Servo-controlled Pressure applied via port (1), therefore one of the two ports (2) or (4) is under pressure.
	Circuit function L (CF L) 5/3-way solenoid valve Servo-controlled, in middle position all ports locked

DTS 1000336890 EN Version: W Status: RL (released | freigegeben | valide) printed: 20.03.2025

3. Approvals and conformities

3.1. General notes

- The approvals and conformities listed below must be stated when making enquiries. This is the only way to ensure that the product complies with all required specifications.
- Not all available variants can be supplied with the below mentioned approvals or conformities.

3.2. Conformity



In accordance with the Declaration of Conformity, the product is compliant with the EU Directives.

Type Rating (NEMA 250, UL50/50E): Type 4X in closed enclosures (8652 with stainless steel variant)



3.3. Standards

The applied standards which are used to demonstrate compliance with the EU Directives are listed in the EU-Type Examination Certificate and/or the EU Declaration of Conformity.

3.4. Explosion protection

Approval	Description
 	<p>Optional: Explosion protection As a category 3 device suitable for zone 2/22.</p> <p>ATEX: BVS 20 ATEX E 031 U II 3G Ex ec IIC Gc II 3D Ex tc IIIC Dc</p> <p>IECEx: IECEx BVS 20.0024 U Ex ec IIC Gc Ex tc IIIC Dc</p>

3.5. North America (USA/Canada)

Approval	Description
	<p>Optional: UL Listed for the USA and Canada The products are UL Listed for the USA and Canada according to:</p> <ul style="list-style-type: none"> • UL 61010-1 (ELECTRICAL EQUIPMENT FOR MEASUREMENT, CONTROL, AND LABORATORY USE – Part 1: General Requirements) • CAN/CSA-C22.2 No. 61010-1 • UL50/50E (Enclosure Type 4X)
	<p>Optional: UL Recognized for the USA and Canada for Hazardous Locations – Explosion protection The products are UL Recognized for Hazardous Locations for the USA and Canada according to: Class I, Zone 2, AEx ec IIC Gc/ Ex ec IIC Gc U Class II, Zone 22, AEx tc IIIC Dc/ Ex tc IIIC Dc U Class I, Division 2, Group A, B, C, D/ Class II, III, Division 2, Group F, G</p>

DTS 1000336890 EN Version: W Status: RL (released | freigegeben | valide) printed: 20.03.2025

3.6. Others

China Compulsory Certification (CCC)

Conformity	Description
	<p>Optional: China Compulsory Certification (CCC) The products with Ex approval are suitable for import and use for hazardous applications in China.</p>

4. Dimensions

4.1. Variant 4-, 8- and 12-fold

Note:

Dimensions in mm, unless otherwise stated

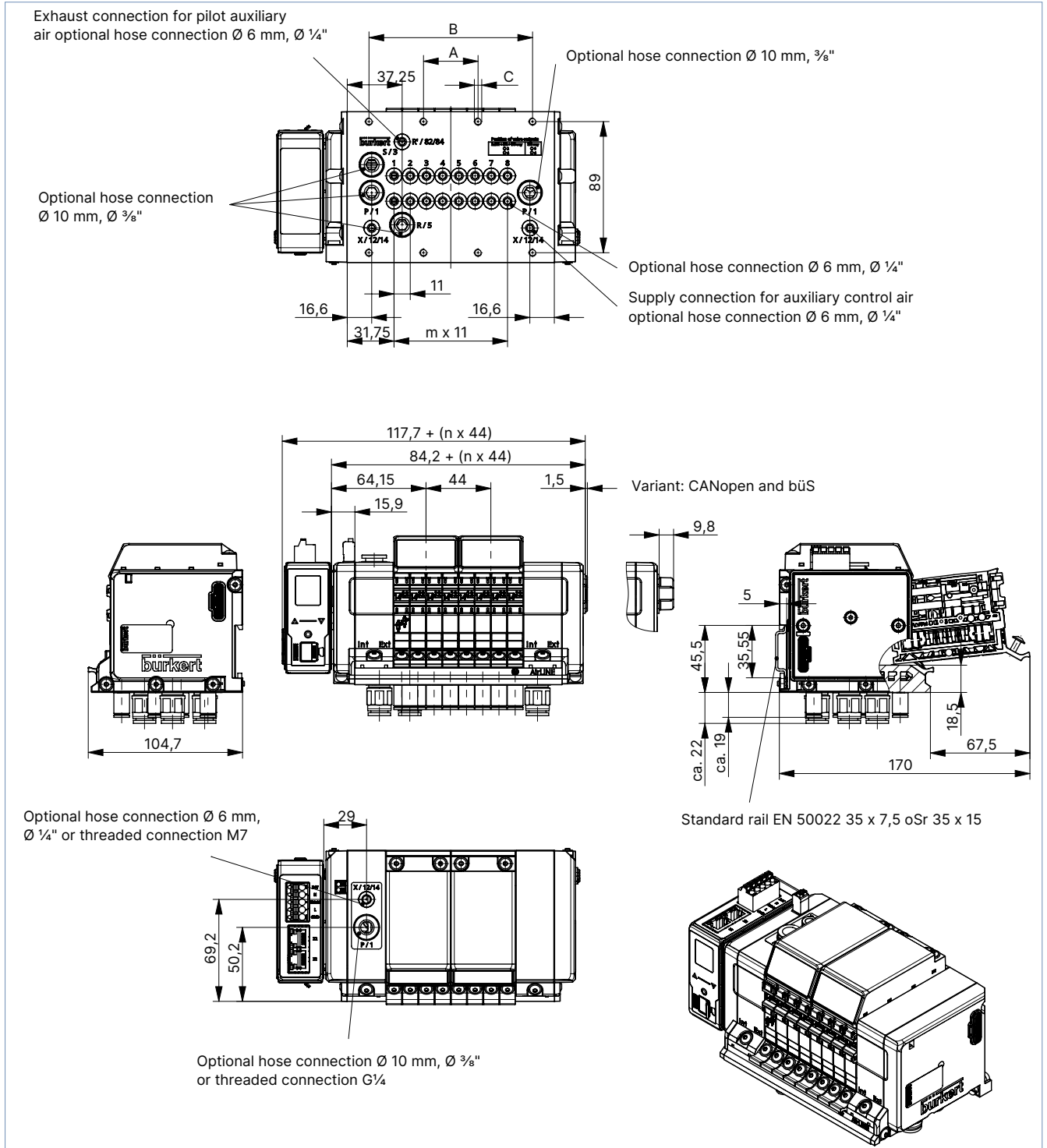

DTS 1000336890 EN Version: W Status: RL (released | freigegeben | valide) printed: 20.03.2025

Variant	A	B	C	m	n
4-fold	66	-	4 x M5	3	1
8-fold	35	111	8 x M5	7	2
12-fold	77	154	10 x M5	11	3

4.2. Variant 16-, 20- and 24-fold

Note:

Dimensions in mm, unless otherwise stated

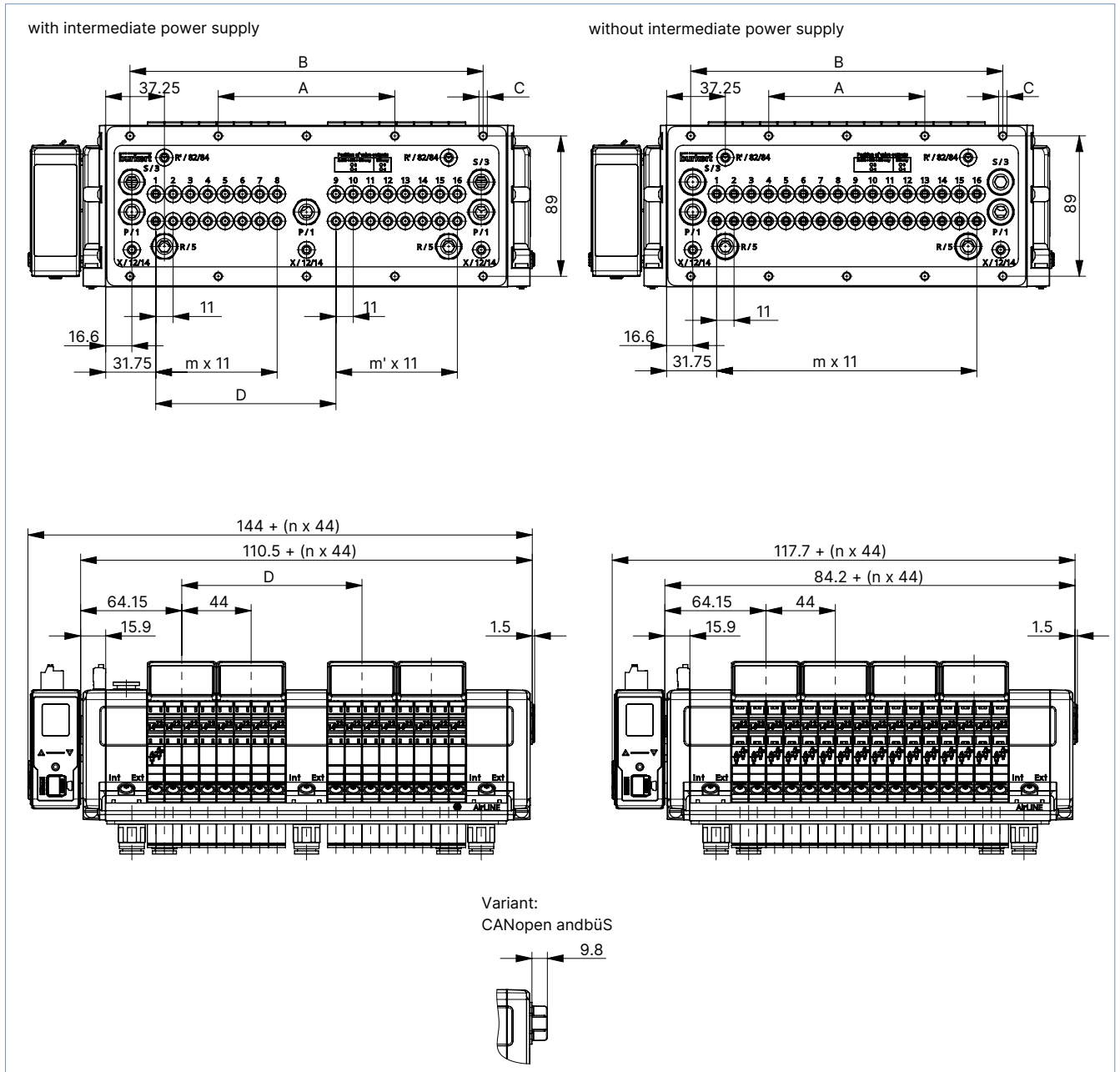

Variant	A	B	C	D	m	m'	n
16-fold with intermediate supply	112	224	10 x M5	114.3	7	7	4
20-fold with intermediate supply	134	268	10 x M5	158.3	11	7	5
24-fold with intermediate supply	156	312	10 x M5	158.3	11	11	6
16-fold without intermediate supply	99	198	10 x M5	-	15	-	4
20-fold without intermediate supply	121	242	10 x M5	-	19	-	5
24-fold without intermediate supply	143	286	10 x M5	-	23	-	6

DTS 1000336890 EN Version: W Status: RL (released | freigegeben | validé) printed: 20.03.2025

5. Device/Process connections

5.1. Power supply for communication and display

Note:

- Connect 5-pin spring-loaded terminal according to the pin assignment.
- Possible cable cross-section: $\leq 1.5 \text{ mm}^2$
- See "9.7. Ordering chart plug" on page 23

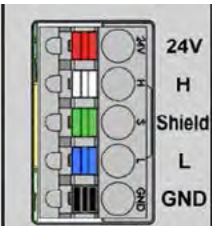
Spring-loaded terminal 5-pin	Colour	Assignment
	Red	24 V DC
	White	CAN_H (bùS connection)
	Green	SHIELDING
	Blue	CAN_L (bùS connection)
	Black	GND

5.2. Power supply for pneumatic valves

Note:

- The interface plate has a 2-pin spring-loaded terminal to which the pneumatic valves' power supply is connected.
- See "9.7. Ordering chart plug" on page 23

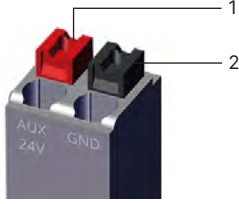
Spring-loaded terminal 2-pin	Clip	Colour	Assignment
	1	Red	AUX 24 V
	2	Black	GND

DTS 1000336890 EN Version: W Status: RL (released | freigegeben | validé) printed: 20.03.2025

5.3. Fieldbus interface

Note:

CANopen requires 2 terminating resistors: one at the beginning of the network and one at the end. An indicator of the correct bus scheduling is the resistance between CAN_H and CAN_L when the power is switched off. This should be approx. 60 Ω.

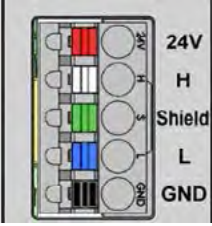
CANopen/büS – Spring terminal 5-pin	Colour	Assignment
	Red	24 V DC
	White	CAN_H (büS connection)
	Green	SHIELDING
	Blue	CAN_L (büS connection)
	Black	GND

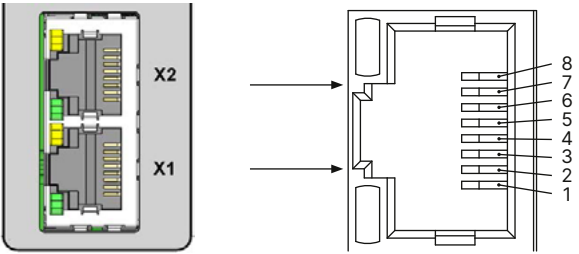
Industrial Ethernet (PROFINET IO, EtherNet/IP, Modbus TCP, EtherCAT, CC-Link IE Field Basic) or PROFINET S2 – Interface X1 and X2 RJ45	Pin	Assignment
	1	TX+
	2	TX-
	3	RX+
	4	N.C.
	5	N.C.
	6	RX-
	7	N.C.
	8	N.C.

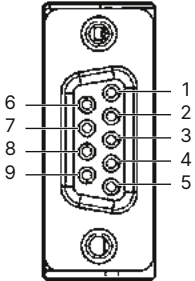
PROFIBUS DPV1 D-Sub 9 – D-Sub 9-pin female	Pin	Assignment
	1	SHIELDING
	2	M24 (optional)
	3	RxD/TxD-P (B-line)
	4	CNTR-P (optional)
	5	DGND
	6	+ 5 V (supply for termination resistor)
	7	+ 24 V (optional)
	8	RxD/TxD-N (A-line)
	9	CNTR-N (optional)

DTS 1000336890 EN Version: W Status: RL (released | freigegeben | validé) printed: 20.03.2025

6. Product installation

6.1. Installation notes

Installation situation of the valve terminal inside the control cabinet

To use the Hot Swap function, always observe a minimum distance to the front edge of the control cabinet when installing the valve island inside the control cabinet. Please also refer to the detailed description in the **operating instructions Type 8652** ▶.

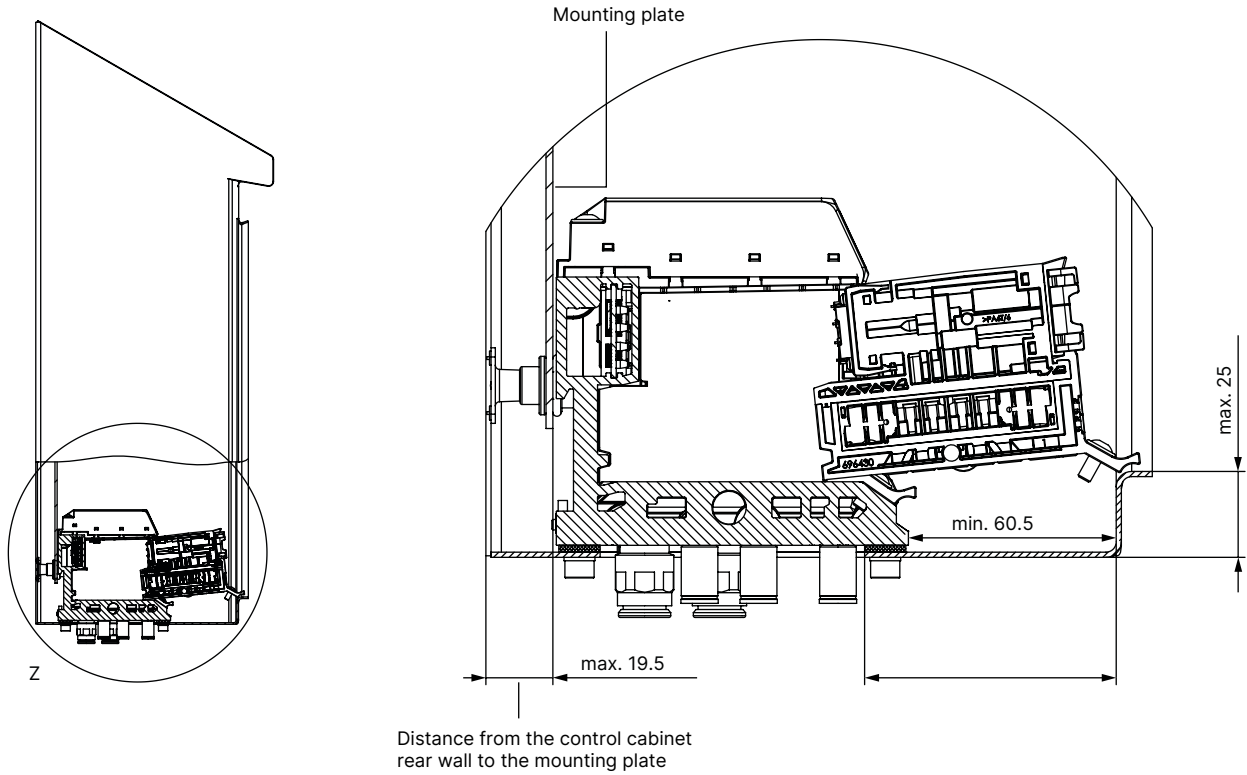

7. Product design and assembly

7.1. Product assembly

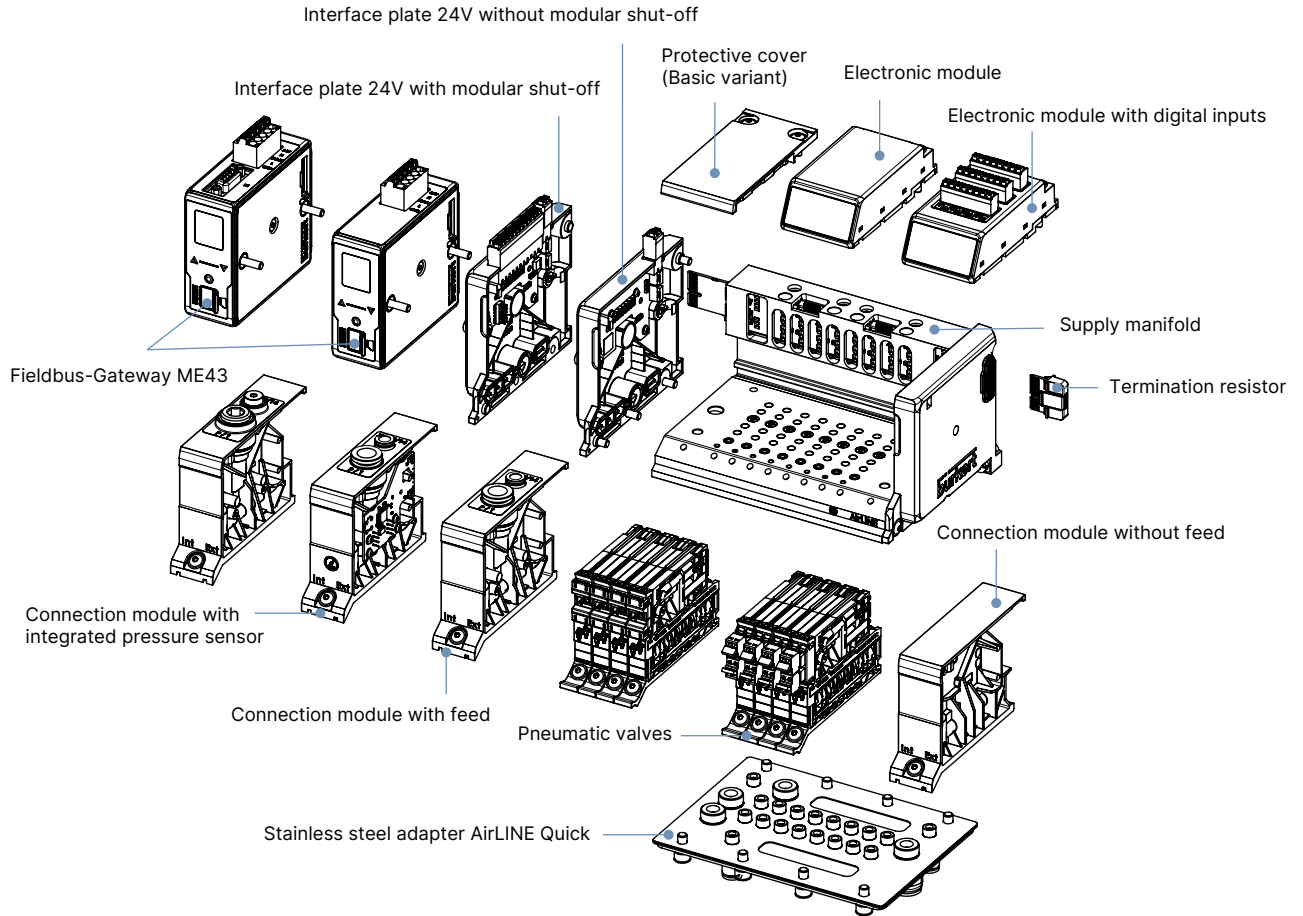

DTS 1000336890 EN Version: W Status: RL (released | freigegeben | valide) printed: 20.03.2025

7.2. Electronic module with digital inputs (optional)

The position feedbacks are supplied (24 V) by the electronic module. Current is limited to maximum 30 mA per position feedback. Standard 3-wire sensors and 2-wire sensors with voltages between 10...30 V as well as mechanical limit switches can be used.

Note:

- Connect the position feedback indicator according to the pin assignment on the electronic module.
- Possible cable cross-section: $\leq 1.5 \text{ mm}^2$
- Maximum cable length: $< 30 \text{ m}$

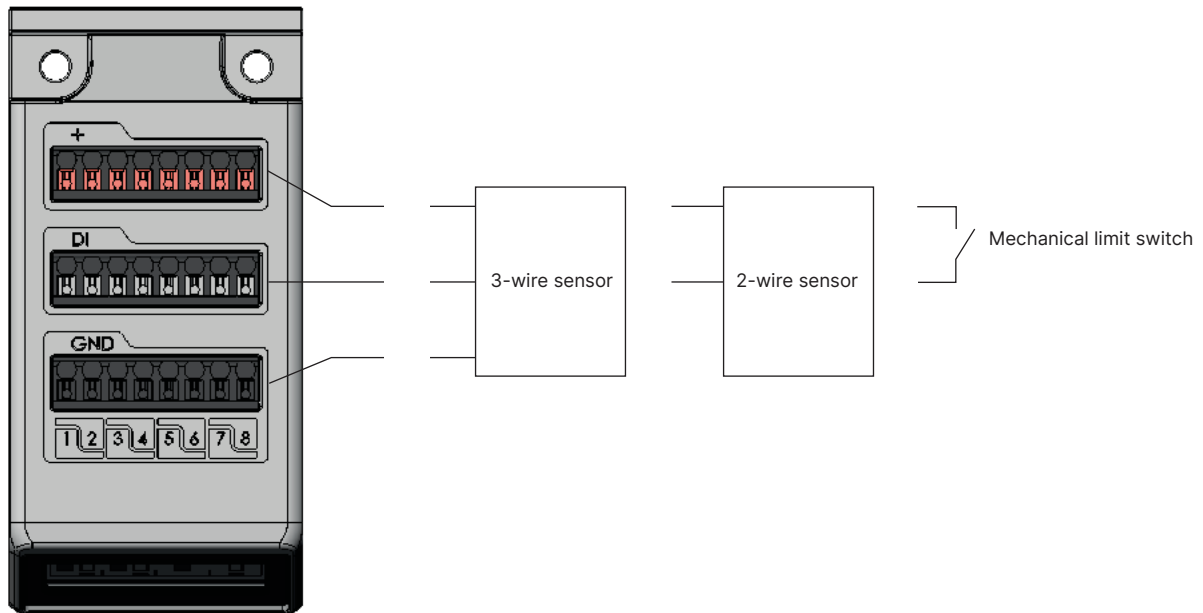

The following data may be displayed depending on the sensor used:

Possible data	3-wire sensors	2-wire sensors	Mechanical limit switches
Sensor actuated	X	X	X
Sensor not actuated	X	X	X
Short circuit	X	-	-
Wire break	-	X	-

8DI-Module (Digital input module)

Product properties	
Diagnosis	Open-circuit detection with 2-wire sensors, short-circuit detection with 3-wire sensors
Electrical data	
Electrical variant	2-wire sensor, 3-wire sensor, mechanical limit switches
Switching threshold	$V_{OFF} = 0...5 \text{ V}$ $V_{ON} = 10...30 \text{ V}$
Input current of V_{ON} , typ. 24 V DC	Max. 5.7 mA per channel
Input impedance	$> 4 \text{ K}\Omega$
Galvanic isolation	No, all channels have a common reference potential

DTS 1000336890 EN Version: W Status: RL (released | freigegeben | valide) printed: 20.03.2025

7.3. Valves Type 6534 for safety-related shut-off, SIA variant (optional)

Note:

- **Type 6534** ▶ valves are equipped with additional connection terminals. A valve circuit can therefore be interrupted by an external switch. Manual override is not required for these valve variants. Technical data of Type 6534 valves, SIA variant correspond to standard device data. To use the shut-off function, connect the terminal to a potential-free contact (mechanical switch or relay).
- The valves **Type 6534** ▶ can only be ordered as spare parts. For more information on the cable plug, see data sheet **Type SV04** ▶.

Feature	Description
	<p>The yellow connection terminals are pluggable and can be removed to facilitate connection of a cable. Except for CF H, there are always 2 connection terminals. To avoid mixing up the connections, the connection terminals are coded.</p> <p>On delivery, the connection terminals are provided with a bridge to ensure the valve can be put into operation immediately. Remove the bridge before connecting a cable.</p>
Connection terminals	Pluggable screw-type terminal, 2-pin, coded wire cross-section (rigid or flexible) 0.14 mm ² ...1.5 mm ² (AWG 28...16)
Required switching capacity of the contact	0.5 A / 24 V DC

Connection designation	Circuit diagram

Connection designation	Circuit diagram

DTS 1000336890 EN Version: W Status: RL (released | freigegeben | validé) printed: 20.03.2025

7.4. Module-based safety shutdown (optional)

Connection designation

Optional: Connections for module-based safety shutdown
Terminal 1 = valve unit 1, Terminal 2 = valve unit 2, ...

To use the switch-off function, connect the connection to a potential-free contact (mechanical switch or relay).

Electrical data	
Connection	Pluggable spring-loaded terminal, 12-pin Conductor cross-section (rigid or flexible) 0.14 mm ² ...1.5 mm ² (AWG 26...16)
Required switching capacity of the contact	1.5 A / 24 V DC

7.5. Example configuration

The following illustration shows a network with the example of AirLINE Type 8652 with Industrial Ethernet variant (PROFINET IO, EtherNet/IP, Modbus TCP, EtherCAT, CC-Link IE Field Basic) as master valve terminal and various AirLINE Type 8652 with büS variant as slave valve terminals.

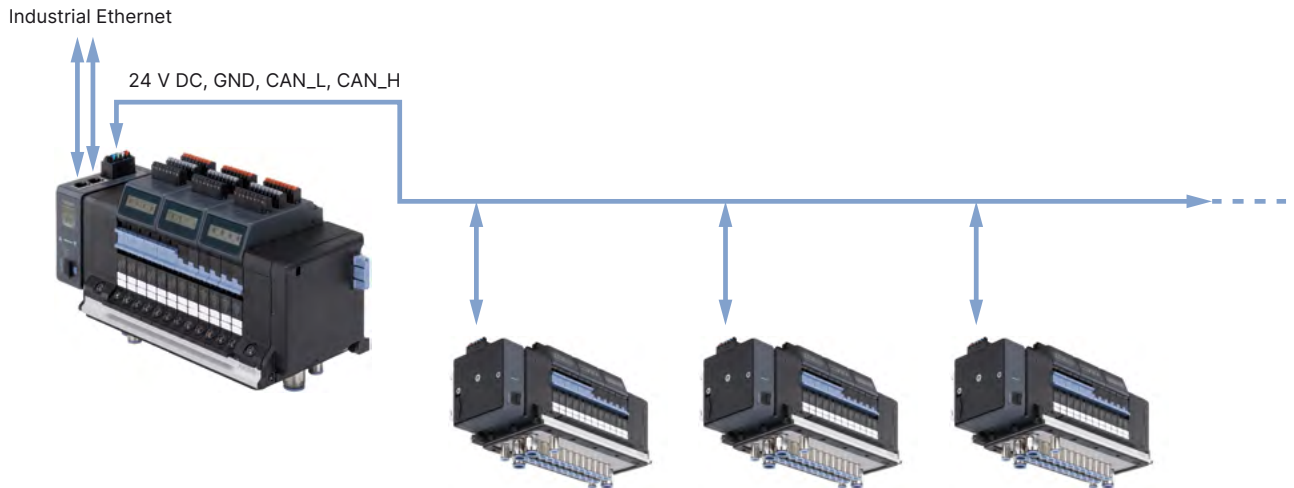

DTS 1000336890 EN Version: W Status: RL (released | freigegeben | valide) printed: 20.03.2025

8. Product accessories

8.1. Bürkert Communicator Software

Note:

The corresponding communication software can be downloaded from the website [Type 8920](#) ▶.

The Bürkert Communicator is the most important software component of the EDIP (Efficient Device Integration Platform). Various features of this universal tool simplify the configuration and parametrisation of devices equipped with a digital CANopen-based interface. With this tool, the user has a complete overview of cyclic process values as well as acyclic diagnostic data. The integrated graphical programming environment enables the creation of decentralised sub-system control functions. The connection to the PC is established with a USB-CAN adapter. The adapter is available as an accessory (see [“9.8. Ordering chart accessories” on page 24](#)).

The Bürkert Communicator enables:

- Configuration, parametrisation and diagnosis of EDIP devices / networks
- Easy and comfortable mapping of cyclic values
- Graphical display of process values
- Firmware update for the connected EDIP devices
- Backup and restoring of device configurations

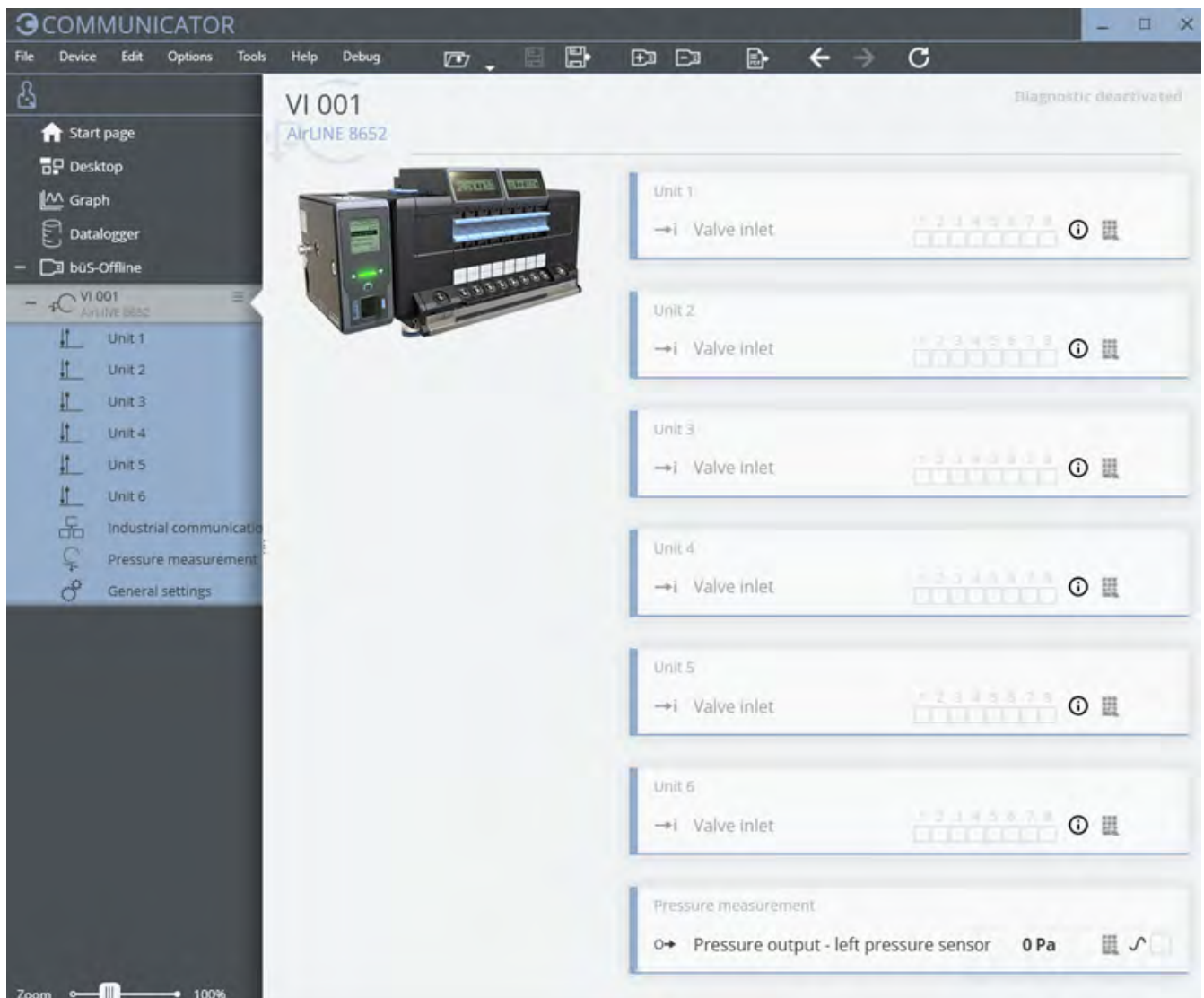

9. Ordering information

9.1. Bürkert eShop



Bürkert eShop – Easy ordering and quick delivery

You want to find your desired Bürkert product or spare part quickly and order directly? Our online shop is available for you 24/7. Sign up and enjoy all the benefits.

[Order online now](#)

9.2. Bürkert configurator



Bürkert configurator – Configuring products easily

You want to put together a product that is precisely tailored to your needs in just a few guided steps? Configure selected Bürkert products with our online configurator.

[Configure product](#)

9.3. Bürkert product filter



Bürkert product filter – Get quickly to the right product

You want to select products comfortably based on your technical requirements? Use the Bürkert product filter and find suitable articles for your application quickly and easily.

[Try out our product filter](#)

9.4. Ordering chart replacement valves

Solenoid valve Type 6534

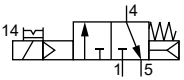
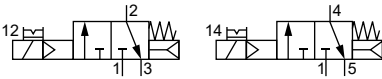
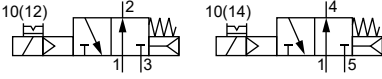
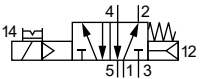
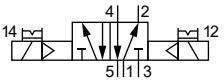
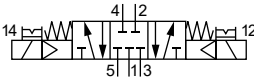
Circuit function	Orifice [mm]	Q _{Nn} value ¹⁾ Air [l/min]	Pressure range [bar]	Switching times		Voltage/ Frequency [V/Hz]	Article no. ²⁾ incl. screw
				Opening [ms]	Closing [ms]		
C (CF C) 3/2-way solenoid valve Servo-controlled, with manual override Normally closed 	4	270 l/min	Vac....10 ³⁾ 3...10	15	15	24 V DC	20102334 REF_20088974
C (CF C) 2 × 3/2-way solenoid valve Servo-controlled, with manual override Normally closed 	4	270 l/min	Vac....10 ³⁾ 3...10	15	15	24 V DC	301374 REF_296031
D (CF D) 2 × 3/2-way solenoid valve Servo-controlled, with manual override Normally open 	4	310 l/min	Vac....10 ³⁾ 3...10	15	15	24 V DC	301375 REF_296032
H (CF H) 5/2-way solenoid valve Servo-controlled, with manual override Pressure applied via port (1), therefore one of the two ports (2) or (4) is under pressure. 	4	290 l/min	Vac....10 ³⁾ 3...10	20	25	24 V DC	301376 REF_296033
Z (CF Z) 5/2-way solenoid valve Impulse variant with 2 coils and manual override Pressure applied via port (1), therefore one of the two ports (2) or (4) is under pressure. 	4	290 l/min	Vac....10 ³⁾ 3...10	20	25	24 V DC	301377 REF_296034
L (CF L) 5/3-way solenoid valve With manual override In middle position all ports locked 	4	275 l/min	Vac....10 ³⁾ 3...10	15	15	24 V DC	301380 REF_296036

DTS 1000336890 EN Version: W Status: RL (released | freigegeben | validé) printed: 20.03.2025

Circuit function	Orifice [mm]	Q _{Nn} value ¹⁾ Air [l/min]	Pressure range [bar]	Switching times		Voltage/ Frequency [V/Hz]	Article no. ²⁾ incl. screw
				Opening [ms]	Closing [ms]		
M (CF M) 5/3-way solenoid valve With manual override In middle position ports 2 and 4 ventilated 	4	300	Vac....10 ³⁾ 3...10	20	20	24 V DC	301379 REF_296035
N (CF N) 5/3-way solenoid valve With manual override In middle position ports 2 and 4 exhausted 	4	300	Vac....10 ³⁾ 3...10	20	20	24 V DC	301381 REF_296039
Dummy valve	-	-	-	-	-	-	335779 REF_327614

1.) Approx. 3 % flow reduction for Hot Swap function
 2.) The valves are components or spare parts of the Type 8652 Valve Terminal and can only be used on the Type 8652 Valve Terminal.
 3.) Separate auxiliary pilot air min. 3 bar. Please observe the pilot pressure table in the **operating instructions Type 8652**

DTS 1000336890 EN Version: W Status: RL (released | freigegeben | validé) printed: 20.03.2025

Solenoid valve Type 6534 SIA variant (2nd port for shutdown)

Note:

Further information about this product variant can be found in chapter **"7.3. Valves Type 6534 for safety-related shut-off, SIA variant (optional)"** on page 16.

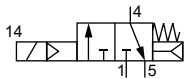
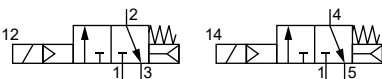
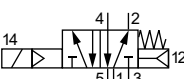
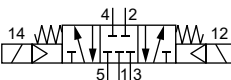
Circuit function	Orifice [mm]	Q _{Nn} value ¹⁾ Air [l/min]	Pressure range [bar]	Switching times		Voltage/ Frequency [V/Hz]	Article no. ²⁾ incl. screw
				Opening [ms]	Closing [ms]		
C (CF C) 3/2-way solenoid valve Servo-controlled Normally closed 	4	270 l/min	Vac....10 ³⁾ 3...10	15	15	24 V DC	20102335 REF_20092052
C (CF C) 2 × 3/2-way solenoid valve Servo-controlled Normally closed 	4	270 l/min	Vac....10 ³⁾ 3...10	15	15	24 V DC	338802 REF_336443
H (CF H) 5/2-way solenoid valve Servo-controlled Pressure applied via port (1), therefore one of the two ports (2) or (4) is under pressure. 	4	290 l/min	Vac....10 ³⁾ 3...10	20	25	24 V DC	338805 REF_336444
L (CF L) 5/3-way solenoid valve In middle position all ports locked 	4	275 l/min	Vac....10 ³⁾ 3...10	15	15	24 V DC	346830 REF_336523

1.) Approx. 3% flow reduction for Hot Swap function







2.) The valves are components or spare parts of the Type 8652 Valve Terminal and can only be used on the Type 8652 Valve Terminal.

3.) Separate auxiliary pilot air min. 3 bar. Please observe the pilot pressure table in the **operating instructions Type 8652**



9.5. Ordering chart electronic module

Beschreibung	Article no.
Electronics module with digital inputs	384872 
Electronics module without digital inputs	384873 

9.6. Ordering chart connector module

Beschreibung	Article no.
Connection module without pressure sensor with additional connection for compressed air supply (Connection size: plug-in coupling Ø 6 mm and Ø 10 mm)	384863 
Connection module without pressure sensor with additional connection for compressed air supply (Connection size: plug-in coupling Ø ¼ mm and Ø ⅜ mm)	384864 
Connection module without pressure sensor without additional connection for compressed air supply	384866 
Connection module with pressure sensor, connection for compressed air supply: plug-in coupling Ø 6 mm and Ø 10 mm	384867 
Connection module with pressure sensor, connection for compressed air supply: plug-in coupling Ø ¼ mm and Ø ⅜ mm	384868 
Connection module without pressure sensor with additional connection for compressed air supply (connection size: G ¼ and M7)	20094669 
Connection module with pressure sensor with additional connection for compressed air supply (connection size: G ¼ and M7)	20094671 

9.7. Ordering chart plug





Beschreibung	Article no.
Spring-loaded terminal 5-pin, power supply for communication and displays	920180 
Spring-loaded terminal 2-pin, power supply for pneumatic valves	920442 

9.8. Ordering chart accessories























Fieldbus gateway Type ME43

Note:

- Please note that the ME43 gateway modules are not configured ex works. However, these absolutely must be configured in order to be used in a system. The device description files must be generated with the Bürkert Communicator software before the start-up of a system.
- Further information can be found in the operating instructions **Type ME43** ►.

Beschreibung	Article no.
Fieldbus gateway Type ME43 – Industrial Ethernet (PROFINET, EtherNet/IP, Modbus TCP, EtherCAT®)	301799 
Fieldbus gateway Type ME43 – Profibus DP	301803 
Fieldbus gateway Type ME43 – CANopen/büS	301802 
Feldbus-Gateway Typ ME43 – PROFINET S2	20081296 

Accessory for Software Bürkert Communicator

Description	Article no.
büS cable extension, M12, cable length: 0.1 m	772492 
büS cable extension, M12, cable length: 0.2 m	772402 
büS cable extension, M12, cable length: 0.5 m	772403 
büS cable extension, M12, cable length: 1 m	772404 
büS cable extension, M12, cable length: 3 m	772405 
büS socket, M12, straight, A-coded	772416 
büS plug, M12, straight, A-coded	772417 
büS socket, M12, angled, A-coded	772418 
büS plug, M12, angled, A-coded	772419 
büS Y plug	772420 
büS Y plug for linking 2 separately supplied segments of a büS network	772421 
Termination resistor (directly pluggable)	303833 
büS plug, M12, terminating resistor 120 Ω	772424 
büS socket, M12, terminating resistor 120 Ω	772425 
Power supply unit Phoenix Class2 (Type 1573), 85...240 V AC/24 V DC, 1.25 A, NEC Class 2 (UL 1310)	772438 
Power supply unit for standard rail (Type 1573), 100...240 V AC/24 V DC, 1 A, NEC Class 2 (UL 1310)	772361 
Power supply unit for standard rail (Type 1573), 100...240 V AC/24 V DC, 2 A, NEC Class 2 (UL 1310)	772362 
Power supply unit for standard rail (Type 1573), 100...240 V AC/24 V DC, 3.8 A, NEC Class 2 (UL60950 - 1)	772898 
Power supply unit for standard rail (Type 1573), 100...240 V AC/24 V DC, 10 A	772698 
microSD card	774087 
USB büS interface set 1 (Type 8923) for connection to the Bürkert Communicator software: includes connection cable (M12 and micro USB), stick with integrated terminating resistor, power supply and software	772426 
USB büS interface set 2 (Type 8923) for connection to the Bürkert Communicator software: including büS stick, connection cable to M12 plug, M12 connection cable on micro USB for the büS service interface and Y distributor, cable length: 0.7 m	772551 
License for graphical programming (only required for a running time > 60 minutes)	567713 
Software Bürkert Communicator	Type 8920 ►

1.) Due to lack of space, the M12 single connectors may not be suitable for their simultaneous use on the same side of the Y connector. Please use the available ready-made assembled cable in this case.