

RTD temperature sensor with IO-Link interface

- Single resistance thermometer Type Pt1000
- Process connections: G ½", clamp DN 10/20 according to DIN 32676
- Temperature measurement range: -50...+150 °C
- Available switching functions: PNP or NPN
- Access to measured value, device status and settings via IO-Link interface, very easy sensor replacement

Product variants described in the data sheet may differ from the product presentation and description.

Type description

The temperature sensor is used for measuring and monitoring the temperature. The impact of the temperature on a resistance thermometer generates a signal which is amplified, digitised and processed.

Instead of an analogue output, this device offers a digital interface IO-Link. This allows bidirectional data transfer with any IO-Link master. Data access occurs via the available standardised IO-Link.

The IO-Link corresponds to the specification version 1.1. The bidirectional communication is used to read process data, parameters, diagnostic information and status messages as well as to set parameters. The two green LEDs are permanently lit as soon as power is supplied to the device. Once an IO-Link connection has been established, the LEDs flash.

The switching behaviour and the switching thresholds of the digital outputs (max. 2; "PNP" or "NPN") can - like many other parameters - be individually configured.

Table of contents

1. General technical data	3
2. Approvals and conformities	5
2.1. Conformity	5
2.2. Standards.....	5
2.3. Pressure Equipment Directive (PED).....	5
Device used on a pipe	5
Device used on a vessel	5
3. Materials	5
3.1. Bürkert resistApp	5
4. Dimensions	6
5. Ordering information	6
5.1. Bürkert eShop.....	6
5.2. Bürkert product filter.....	7
5.3. Ordering chart.....	7

1. General technical data

Product properties	
Material	
Make sure the device materials are compatible with the fluid you are using. Further information can be found in chapter "3.1. Bürkert resistApp" on page 5.	
Non wetted parts	
Housing	<ul style="list-style-type: none"> Thread connection variant: stainless steel 1.4404 (316L) Clamp connection variant: stainless steel 1.4571 (316Ti)
Fixed connector	<ul style="list-style-type: none"> Thread connection variant: stainless steel 1.4404 (316L), PBT GF 6.5 Clamp connection variant: stainless steel 1.4571 (316Ti), PBT GF 6.5
Wetted parts	
Process connection	<ul style="list-style-type: none"> Thread connection variant: stainless steel 1.4404 (316L) Clamp connection variant: stainless steel 1.4435 (316L), with low delta ferrite content
Protection tube	<ul style="list-style-type: none"> Thread connection variant: stainless steel 1.4404 (316L) Clamp connection variant: stainless steel 1.4435 (316L)
Dimensions	Further information can be found in chapter "4. Dimensions" on page 6.
Weight	Approx. 80 g for the variant with thread connection and 100 mm probe length The weight of the temperature sensor depends on the process connection and the insertion length.
Measuring element	RTD temperature probe Pt1000, four-wire circuit
Measuring probe length	50 or 100 mm
Measuring range	-50...+150 °C (-58...+302 °F)
Monitoring	Measuring circuit: IO-Link event configurable and is available as device status <ul style="list-style-type: none"> Process data invalid Measuring range overflow Measuring range underflow Device hardware fault
Additional function	<ul style="list-style-type: none"> Fine adjustment Change between °C/°F Data format switchover (integer/floating point) Switching outputs in SIO mode
Performance data	
Sampling rate	160 ms
Transmission behaviour	Temperature linear
Measuring resolution	14 bit
Measurement deviation	<ul style="list-style-type: none"> Tolerance class A, $\pm(0.15 + 0.002 \times t ^{1.3})$ °C according to EN 60751:2009/IEC 60751:2008 $\leq \pm(0.08 \%)^{2.3}$ (calibration of the electronic components)
Response time	Protection tube Ø6 mm (standard): <ul style="list-style-type: none"> $t_{0.5} = 5$ s; $t_{0.9} = 12$ s, in water with a flow velocity of 0.4 m/s $t_{0.5} = 40$ s; $t_{0.9} = 110$ s, in air with a flow velocity of 3.0 m/s
Electrical data	
Operating voltage	<ul style="list-style-type: none"> In IO-Link operation: 18...32 V DC, filtered and regulated In switch operation: 9.6...32 V DC, filtered and regulated Nominal voltage: 24 V DC
Power source (not supplied)	The auxiliary energy of the pressure sensor must meet SELV requirements; optionally, an energy-limited current circuit according to paragraph 9.3 of DIN EN 61010-1 and UL 61010-1 can be used
DC reverse polarity protection	Yes
Short circuit protection	Yes (clocked)
Protection class	Class III according to EN 61140
Current consumption	<ul style="list-style-type: none"> In idle operation: ≤ 12 mA (at nominal voltage) In IO-Link operation: ≤ 20 mA (at nominal voltage) In switch operation: ≤ 200 mA (at nominal voltage and with 2 digital outputs)
Galvanic isolation	To the protection tube; no galvanic isolation between sensor and output
Signal processing	Input filter: <ul style="list-style-type: none"> digital filter, second order filter time constant can be set

Output

Number of outputs	<ul style="list-style-type: none"> 1 digital output in IO-Link operation 2 digital outputs for switch operation (SIO mode; SIO = standard IO)
Switching function configurable	<ul style="list-style-type: none"> Hysteresis function (Hysteresis configurable) or window function (fixed setting, symmetrical, $\pm 0.25\%$ of the measuring range) NC or NO contact Digital output PNP or NPN Switch-on/switch-off delay (0...100 s)
Measuring current	$\leq 500 \mu\text{A}$
Switching current	$\leq 100 \text{ mA}$ per output
Current limiting	Yes
Voltage drop at switching transistor	$\leq 2 \text{ V DC}$
Recommended connection cable	4-wire unshielded cable, max. 20 m

Medium data

Fluid	Liquid and gaseous medium
Fluid pressure	<ul style="list-style-type: none"> G $\frac{1}{2}$" process connection: Max. 40 bar Clamp DN 10/20, according to DIN 3676. The permissible pressures are designed for an operating temperature range of -10 to +140 °C given use of suitable clamps and sealing materials.

Process/Port connection & communication

Process connection	<ul style="list-style-type: none"> G $\frac{1}{2}$" according to EN 837 Clamp DN 10/20 according to DIN 32676 <p>Further information on the process connection can be found in chapter "5.3. Ordering chart" on page 7.</p>
Electrical connection	M12 x 1 male connector, 4 pins, A-coded, non rotating (IO-Link Port Class A)

Digital communication: IO-Link

Communication interface	IO-Link device V1.1, downward compatible to V1.0
Data transfer rate (Baud rate)	COM 3 (230.4 kBd)
Cycle time	Min. 2 ms
IO device description (IODD)	Depending on the ordered input range See "Device Description Files" on the website in the Software chapter Type 8418 ▶ available or at https://ioddfinder.io-link.com

Approvals and conformities

Directives

CE directive	Further information on the CE Directive can be found in chapter "2.2. Standards" on page 5.
Pressure equipment directive	<ul style="list-style-type: none"> The device does not meet the requirements for "safety accessories" within the meaning of the Pressure Equipment Directive 2014/68/EU. Complying with article 4, paragraph 1 of 2014/68/EU directive. Further information on the pressure equipment directive can be found in chapter "2.3. Pressure Equipment Directive (PED)" on page 5.

Environment and installation

Ambient temperature	Operation ^{3.)} and storage: -40...+85 °C (-40...+185 °F)
Temperature influence	$\leq \pm 0.0025\%$ per K ^{2.)4.)}
Relative air humidity	<ul style="list-style-type: none"> During operation: $\leq 100\%$, without condensation on the outer housing surface of the device During storage: $\leq 90\%$, without condensation
Climate class	3K7 according to EN 60721-3-3
Application range	A
Degree of protection according to IEC/EN 60529	IP66/IP67/IP69 with connector screwed on
Mounting position	Unrestricted

1.) |t| = temperature value in °C regardless of the prefix sign

2.) All accuracy specifications in % in relation to the respective measuring range span

3.) At process temperatures > 120 °C, the maximum permissible ambient temperature is +60 °C (stated at nominal voltage of 24 V DC).

4.) In relation to the temperature deviation at calibration point (25 °C $\pm 5 \text{ K}$)

2. Approvals and conformities

2.1. Conformity

In accordance with the Declaration of Conformity, the product is compliant with the EU Directives.

2.2. Standards

The applied standards which are used to demonstrate compliance with the EU Directives are listed in the EU-Type Examination Certificate and/or the EU Declaration of Conformity.

2.3. Pressure Equipment Directive (PED)

The device conforms to article 4, paragraph 1 of the Pressure Equipment Directive (PED) 2014/68/EU under the following conditions:

Device used on a pipe

Note:

- The data in the table is independent of the chemical compatibility of the material and the fluid.
- PS = maximum admissible pressure (in bar), DN = nominal diameter of the pipe

Type of fluid	Conditions
Fluid group 1, article 4, paragraph 1.c.i	DN ≤ 25
Fluid group 2, article 4, paragraph 1.c.i	DN ≤ 32 or PS*DN ≤ 1000
Fluid group 1, article 4, paragraph 1.c.ii	DN ≤ 25 or PS*DN ≤ 2000
Fluid group 2, article 4, paragraph 1.c.ii	DN ≤ 200 or PS ≤ 10 or PS*DN ≤ 5000

Device used on a vessel

Note:

- The data in the table is independent of the chemical compatibility of the material and the fluid.
- PS = maximum admissible pressure (in bar), V = vessel volume

Type of fluid	Conditions
Fluid group 1, article 4, paragraph 1.a.i	V > 1 L and PS*V ≤ 25 bar.L or PS ≤ 200 bar
Fluid group 2, article 4, paragraph 1.a.i	V > 1 L and PS*V ≤ 50 bar.L or PS ≤ 1000 bar
Fluid group 1, article 4, paragraph 1.a.ii	V > 1 L and PS*V ≤ 200 bar.L or PS ≤ 500 bar
Fluid group 2, article 4, paragraph 1.a.ii	PS > 10 bar and PS*V ≤ 10000 bar.L or PS ≤ 1000 bar

3. Materials

3.1. Bürkert resistApp

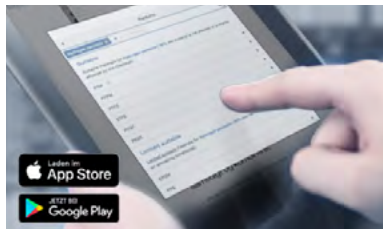

Bürkert resistApp – Chemical resistance chart

You want to ensure the reliability and durability of the materials in your individual application case? Verify your combination of media and materials on our website or in our resistApp.

[Start chemical resistance check](#)

DTS 1000416970 EN Version: C Status: RL (released | freigegeben | validé) printed: 18.12.2024

4. Dimensions

Note:

Dimensions in mm, unless otherwise stated

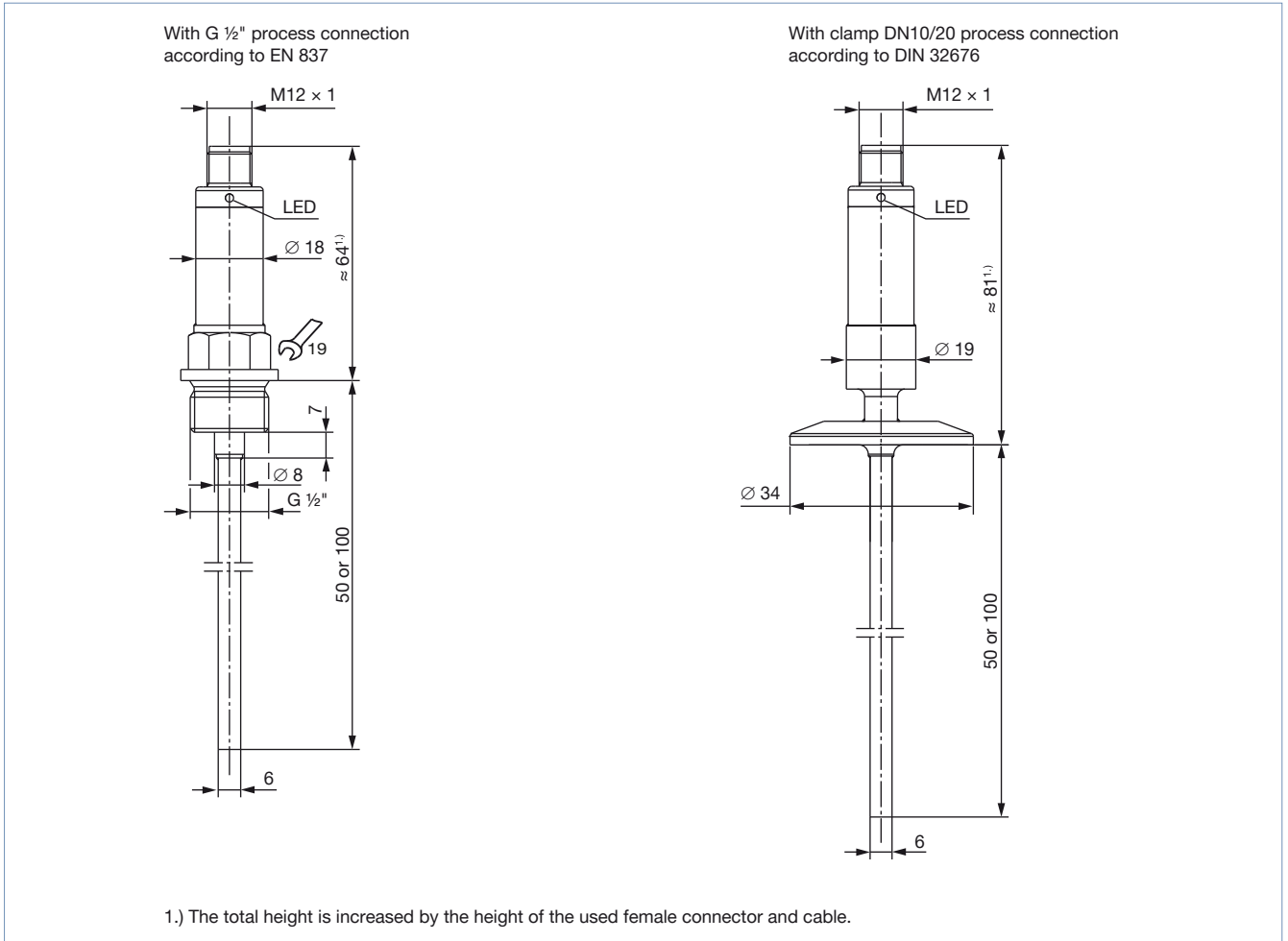

5. Ordering information

5.1. Bürkert eShop



Bürkert eShop – Easy ordering and quick delivery

You want to find your desired Bürkert product or spare part quickly and order directly? Our online shop is available for you 24/7. Sign up and enjoy all the benefits.

[Order online now](#)

5.2. Bürkert product filter

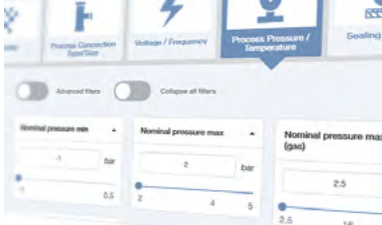

Bürkert product filter – Get quickly to the right product

You want to select products comfortably based on your technical requirements? Use the Bürkert product filter and find suitable articles for your application quickly and easily.

[Try out our product filter](#)





5.3. Ordering chart

Note:

The following variants have

- an operating voltage depending on operation mode (IO-Link: 18...32 V DC, Switch: 9.6...32 V DC or Nominal: 24 V DC)
- an IO-Link digital interface (according to specification version 1.1) or digital outputs (SIO mode; SIO = standard IO)

Temperature range [°C]	Process connection	Probe length [mm]	Article no.
-50...+150	G ½" according to EN 837	50	574634
		100	574635
	Clamp DN 10/20 according to DIN 32676	50	574636
		100	574637

Further variants on request	
 <p>Process connection</p> <ul style="list-style-type: none"> • Screw-in thread G ¾" • Screw-in thread M12 x 1.5 and G ½" with CIP-compliant conical seal • Aseptic screw-in thread DN 20, DN 25, DN 32, DN 40, DN 50 according to DIN 11864-1 form A • Taper socket with union nut DN 10, DN 25, DN 32 according to DIN 11851 (dairy pipe fitting) • Clamping socket (clamp) DN 10/20, DN 25/40 according to DIN 32676 • Clamping socket (clamp) DN 50 according to DIN 32676 (2" ISO 2852) • Clamping socket (clamp) 2 ½" similar to DIN 32676 • Ball welding socket with threaded compression fitting • Welding socket with CIP-compliant conical seal • VARIVENT® connection DN 15/10, DN 32/25 or DN 50/40 • BioControl® D25, D50, D65 or D80 	<div style="margin-bottom: 10px;">  <p>Temperature -50...+260 °C (-58...+500 °F)</p> </div> <div style="margin-bottom: 10px;">  <p>Electrical connection IO-Link, M12 x 1 connector, high-temperature</p> </div> <div style="margin-bottom: 10px;">  <p>Additional</p> <ul style="list-style-type: none"> • Pt1000 temperature sensor, four-wire circuit • Class AA according to EN 60751:2009 / IEC 60751:2008 • With protection tube diameter 3 mm only with screw-in thread M12 x 1.5 with CIP-compliant conical seal • Insertion length: 15, 20, 25 only with screw-in thread M12 x 1.5 with CIP-compliant conical seal or 150 mm </div> <div>  <p>Certification</p> <ul style="list-style-type: none"> • Inspection certificate 3.1 DIN EN 10204 (material) • Special calibration </div>

DTS 1000416970 EN Version: C Status: RL (released | freigegeben | valide) printed: 18.12.2024