

Pressure transmitter with IO-Link interface

- Metallic thin film strain gauges measuring principle
- Process connections: G, NPT in 1/4", G 3/4" with hygienic flush diaphragm or clamp according to DIN 32676
- Measuring ranges for relative pressure from -0.4...+0.4 bar up to -1...+12.0 bar
- Available switching functions: PNP or NPN
- Access to measured value, device status and settings via IO-Link interface, very easy sensor replacement

Product variants described in the data sheet may differ from the product presentation and description.

Type description

The pressure transmitter is used to measure and monitor relative and absolute (on request) pressure in liquids and gases. The effect of the pressure on the sensor element generates a signal which is amplified, digitised and processed.

Instead of an analogue output, this device offers a digital interface IO-Link. This allows bidirectional data transfer with any IO-Link master. Data access occurs via the available standardised IODD.

The IO-Link corresponds to the specification version 1.1. The bidirectional communication is used to read process data, parameters, diagnostic information and status messages as well as to set parameters. The two green LEDs are permanently lit as soon as power is supplied to the device. Once an IO-Link connection has been established, the LEDs flash.

The switching behaviour and the switching thresholds of the digital outputs (max. 2; "PNP" or "NPN") can - like many other parameters - be individually configured.

Table of contents

1. General technical data	3
2. Approvals	6
2.1. Pressure equipment directive	6
Device used on a pipe	6
Device used on a vessel	6
3. Materials	6
3.1. Chemical Resistance Chart – Bürkert resistApp.....	6
4. Dimensions	7
5. Ordering information	8
5.1. Bürkert eShop – Easy ordering and quick delivery	8
5.2. Bürkert product filter	8
5.3. Ordering chart.....	8

1. General technical data

Product properties

Material

Make sure the device materials are compatible with the fluid you are using.

Detailed information can be found in chapter **"3.1. Chemical Resistance Chart – Bürkert resistApp"** on page 6.

Non wetted parts

Housing	Stainless steel 1.4301 (304)
Circular connector	Stainless steel 1.4301 (304)

Wetted parts

Process connection	Stainless steel 1.4404 (316L)
Measuring element	<ul style="list-style-type: none"> • Membrane in stainless steel 1.4435 (316L) • Welding ring in stainless steel 1.4404 (316L)

Dimensions	Detailed information can be found in chapter "4. Dimensions" on page 7.
------------	--

Weight	Approx. 160 g
--------	---------------

Measurement technology	Metallic thin film strain gauge
------------------------	---------------------------------

Measured quantity	Relative pressure (absolute pressure on request)
-------------------	--

Measuring range	<ul style="list-style-type: none"> • -0.4...+0.4 bar • -1...+1 bar • -1...+2.5 bar • -1...+5.0 bar • -1...+12.0 bar
-----------------	--

Monitoring	<p>Measuring circuit: IO-Link event configurable and is available as device status</p> <ul style="list-style-type: none"> • Process data invalid • Measuring range overflow • Measuring range underflow • Device hardware fault
------------	---

Performance data

Compensated ambient temperature range (T_{amb})	-20...+80 °C (-4...+176 °F)
---	-----------------------------

Temperature coefficient (Tc)	In compensated T° range
Average Tc of zero	<p>Variant with measuring range</p> <ul style="list-style-type: none"> • -0.4...+0.4 bar: 0.020 %/°C • -1...+1 bar, -1...+2.5 bar: 0.015 %/°C • -1...+5.0 bar, -1...+12.0 bar: 0.010 %/°C
Average Tc of measuring span	Variant with measuring range -0.4...+0.4 bar, -1...+1 bar, -1...+2.5 bar, -1...+5.0 bar or -1...+12.0 bar: 0.010 %/°C

Thermal hysteresis	<p>Variant with measuring range</p> <ul style="list-style-type: none"> • -0.4...+0.4 bar: 0.15 % of measuring span • -1...+1 bar, -1...+2.5 bar, -1...+5.0 bar, -1...+12.0 bar: 0.10 % of measuring span
--------------------	--

Zero offset	<p>Variant with measuring range</p> <ul style="list-style-type: none"> • -0.4...0.4 bar: 0.30 % of measuring span • -1...+1 bar, -1...+2.5 bar: 0.15 % of measuring span • -1...+5.0 bar, -1...+12.0 bar: 0.10 % of measuring span
-------------	---

Measuring resolution	14 bit
----------------------	--------

Measurement deviation	<ul style="list-style-type: none"> At 20 °C¹⁾, variant with measuring range <ul style="list-style-type: none"> -0.4...+0.4 bar: 0.7 % of measuring span -1...+1 bar: 0.6 % of measuring span -1...+2.5 bar: 0.5 % of measuring span -1...+5.0 bar: 0.5 % of measuring span -1...+12.0 bar: 0.5 % of measuring span At -20 °C...+80°C²⁾, variant with measuring range <ul style="list-style-type: none"> -0.4...+0.4 bar: 2.0 % of measuring span -1...+1 bar: 1.8 % of measuring span -1...+2.5 bar: 1.3 % of measuring span -1...+5.0 bar: 1.2 % of measuring span -1...+12.0 bar: 1.0 % of measuring span
Linearity ³⁾	<p>Variant with measuring range</p> <ul style="list-style-type: none"> -0.4...+0.4 bar, -1...+1 bar, -1...+2.5 bar or -1...+5.0 bar: 0.3 % of measuring span -1...+12.0 bar: 0.25 % of measuring span
Hysteresis	<p>Variant with measuring range -0.4...+0.4 bar, -1...+1 bar, -1...+2.5 bar, -1...+5.0 bar or -1...+12.0 bar: 0.05 % of measuring span</p>
Response time	<ul style="list-style-type: none"> Digital switching output: ≤ 7 ms IO-Link: ≤ 9 ms
Overload limit ⁴⁾	<p>Variant with measuring range</p> <ul style="list-style-type: none"> -0.4...+0.4 bar: 1 bar -1...+1 bar: 4 bar -1...+2.5 bar: 16 bar -1...+5.0 bar: 40 bar -1...+12.0 bar: 100 bar
Burst pressure	<p>Variant with measuring range</p> <ul style="list-style-type: none"> -0.4...+0.4 bar: 1.5 bar -1...+1 bar: 8 bar -1...+2.5 bar: 24 bar -1...+5.0 bar: 60 bar -1...+12.0 bar: 150 bar
Stability ⁵⁾	<p>Per year, variant with measuring range</p> <ul style="list-style-type: none"> -0.4...+0.4 bar: ≤ 0.3 % of measuring span -1...+1 bar, -1...+2.5 bar, -1...+5.0 bar or -1...+12.0 bar: ≤ 0.2 % of measuring span
Behaviour of measuring range (IO-Link specification)	<ul style="list-style-type: none"> Underrange: <ul style="list-style-type: none"> linear up to -1.5 % of measuring span error value: 1×10^{37} Overrange: <ul style="list-style-type: none"> linear up to 5 % of measuring span error value: 2×10^{37}
Electrical data	
Operating voltage	<ul style="list-style-type: none"> In IO-Link operation: 18...32 V DC, filtered and regulated In switch operation: 9.6...32 V DC, filtered and regulated Nominal voltage: 24 V DC
Power source (not supplied)	The auxiliary energy of the pressure sensor must meet SELV requirements; optionally, an energy-limited current circuit according to paragraph 9.3 of DIN EN 61010-1 and UL 61010-1 can be used.
DC reverse polarity protection	Yes
Overvoltage protection	No
Short circuit protection	Yes (clocked)
Protection class	Class III according to EN 61140

Current consumption	<ul style="list-style-type: none"> In idle operation: ≤ 10 mA In IO-Link operation: ≤ 12 mA In switch operation: ≤ 250 mA (with two digital outputs)
Galvanic isolation	To pressure connection available
Signal processing	Input filter: <ul style="list-style-type: none"> digital filter, second order filter time constant can be set
Output	
Number of outputs	<ul style="list-style-type: none"> 1 digital output in IO-Link operation 2 digital outputs for switch operation (SIO mode; SIO = standard IO)
Switching function configurable	<ul style="list-style-type: none"> Hysteresis function (Hysteresis configurable) or window function (fixed setting, symmetrical, ± 0.25 % of the measuring range) NC or NO contact Digital output PNP or NPN Switch-on/switch-off delay (0...100 s)
Switching current	≤ 100 mA per output
Current limiting	Yes
Voltage drop at switching transistor	≤ 2 V DC
Recommended connection cable	4-wire unshielded cable, max. 20 m
Medium data	
Fluid	Liquid and gaseous medium
Fluid temperature	$-40 \dots +125$ °C ($-40 \dots +257$ °F)
Process/Pipe connection & communication	
Process connection	<ul style="list-style-type: none"> G ¼" or NPT ¼" (according to EN 837) G ¾" flush diaphragm (according to ISO 228-1) Clamp DN 10/20 (according to DIN 32676) Detailed information on the process connection can be found in chapter "5.3. Ordering chart" on page 8.
Electrical connection	M12×1 circular male connector, 4 pins, A-coded, non rotating (IO-Link Port Class A)
Digital communication: IO-Link	
Communication interface	IO-Link device V1.1, downward compatible to V1.0
Baud rate (data transfer rate)	COM 3 (230.4 kBaud)
Cycle time	Min. 2 ms
IO device description (IODD)	Depending on the ordered measurement range See "Device Description Files" on the website in the Software chapter Type 8318 ► or available at https://ioddfinder.io-link.com
Approvals and certificates	
Directives	
CE directive	The applied standards, which verify conformity with the EU Directives, can be found on the EU Type Examination Certificate and/or the EU Declaration of conformity (if applicable)
Pressure equipment directive	<ul style="list-style-type: none"> The device does not meet the requirements for "safety accessories" within the meaning of the pressure equipment directive 2014/68/EU. Complying with article 4, paragraph 1 of 2014/68/EU directive Detailed information on the pressure equipment directive can be found in chapter "2.1. Pressure equipment directive" on page 6.
Environment and installation	
Ambient temperature	Operation and storage: $-40 \dots +85$ °C ($-40 \dots +185$ °F)
Relative air humidity	<ul style="list-style-type: none"> During operation: ≤ 100 %, without condensation on the outer housing surface of the device During storage: ≤ 90 %, without condensation
Climate class	3K7 according to EN 60721-3-3
Application range	Indoors and outdoors Protect the device against electromagnetic interference, ultraviolet rays and, when installed outdoors, against the effects of climatic conditions.
Degree of protection	IP65 according to DIN EN 60529, with female connector screwed on (for absolute pressure variant IP65/IP67)

Mounting position	<ul style="list-style-type: none"> • Installation: unrestricted • Calibration: device upright, process connection at the bottom
-------------------	---

- 1.) Includes linearity, hysteresis, repeatability, deviation of measuring range initial value and measuring range end value
- 2.) Includes linearity, hysteresis, repeatability, deviation of measuring range initial value, measuring range end value, thermal effect on measuring range start and measuring span
- 3.) Linearity according to limit point setting
- 4.) All sensors are vacuum proof.
- 5.) Reference conditions EN 61298-1

2. Approvals

2.1. Pressure equipment directive

The device conforms to article 4, paragraph 1 of the pressure equipment directive 2014/68/EU under the following conditions:

Device used on a pipe

Note:

- The data in the table is independent of the chemical compatibility of the material and the fluid.
- PS = maximum admissible pressure (in bar), DN = nominal diameter of the pipe

Type of fluid	Conditions
Fluid group 1, article 4, paragraph 1.c.i	$DN \leq 25$
Fluid group 2, article 4, paragraph 1.c.i	$DN \leq 32$ or $PS \cdot DN \leq 1000$
Fluid group 1, article 4, paragraph 1.c.ii	$DN \leq 25$ or $PS \cdot DN \leq 2000$
Fluid group 2, article 4, paragraph 1.c.ii	$DN \leq 200$ or $PS \leq 10$ or $PS \cdot DN \leq 5000$

Device used on a vessel

Note:

- The data in the table is independent of the chemical compatibility of the material and the fluid.
- PS = maximum admissible pressure (in bar), V = vessel volume

Type of fluid	Conditions
Fluid group 1, article 4, paragraph 1.a.i	$V > 1$ L and $PS \cdot V \leq 25$ bar.L or $PS \leq 200$ bar
Fluid group 2, article 4, paragraph 1.a.i	$V > 1$ L and $PS \cdot V \leq 50$ bar.L or $PS \leq 1000$ bar
Fluid group 1, article 4, paragraph 1.a.ii	$V > 1$ L and $PS \cdot V \leq 200$ bar.L or $PS \leq 500$ bar
Fluid group 2, article 4, paragraph 1.a.ii	$PS > 10$ bar and $PS \cdot V \leq 10000$ bar.L or $PS \leq 1000$ bar

3. Materials

3.1. Chemical Resistance Chart – Bürkert resistApp

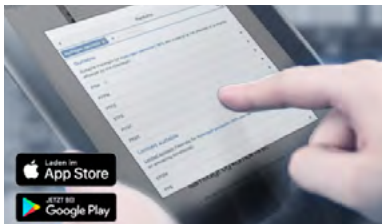

Bürkert resistApp – Chemical Resistance Chart

You want to ensure the reliability and durability of the materials in your individual application case? Verify your combination of media and materials on our website or in our resistApp.

[Start Chemical Resistance Check](#)

4. Dimensions

Note:

Dimensions in mm, unless otherwise stated

With G 1/4" process connection according to EN 837

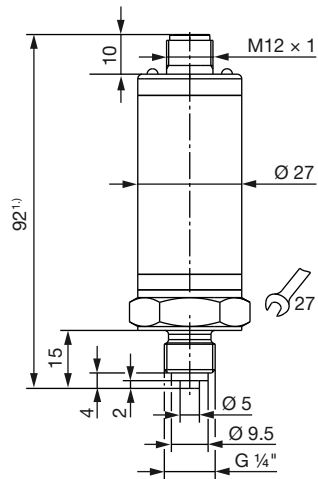

With NPT 1/4" process connection according to EN 837

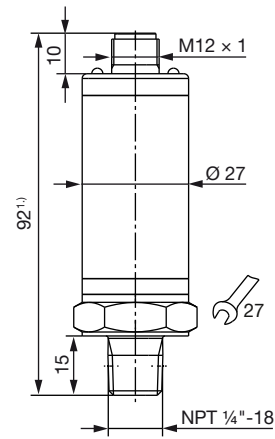

With G 3/4" front-flush process connection according to ISO 228-1

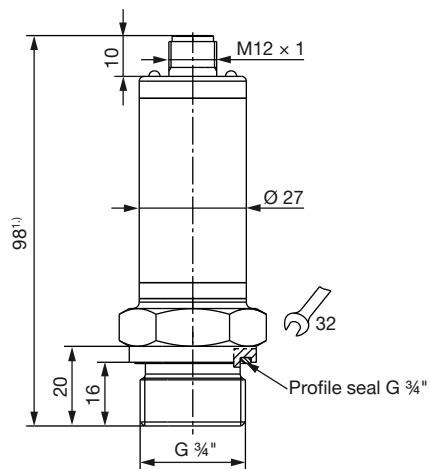

With clamp DN10/20 process connection according to DIN 32676

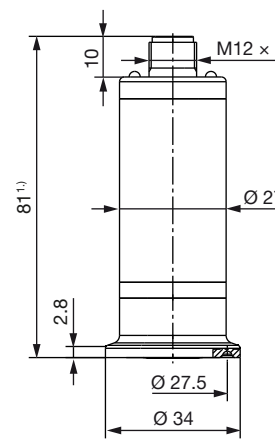

1.) The total height is increased by the height of the used female connector and cable .

5. Ordering information

5.1. Bürkert eShop – Easy ordering and quick delivery



Bürkert eShop – Easy ordering and quick delivery

You want to find your desired Bürkert product or spare part quickly and order directly? Our online shop is available for you 24/7. Sign up and enjoy all the benefits.

[Order online now](#)

5.2. Bürkert product filter



Bürkert product filter – Get quickly to the right product

You want to select products comfortably based on your technical requirements? Use the Bürkert product filter and find suitable articles for your application quickly and easily.





















[Try out our product filter](#)

5.3. Ordering chart

Note:

The following variants have

- an operating voltage depending on operation mode (IO-Link: 18...32 V DC, Switch: 9.6...32 V DC or Nominal: 24 V DC)
- an IO-Link digital interface (according to specification version 1.1) or digital outputs (SIO mode; SIO = standard IO)

Process connection	Pressure range (relative pressure)	Burst pressure (relative pressure)	Article no.
	[bar]	[bar]	
G 1/4" according to EN 837	-0.4...+0.4	1.5	574614 
	-1...+1	8	574615 
	-1...+2.5	24	574616 
	-1...+5	60	574617 
	-1...+12	150	574618 
NPT 1/4" according to EN 837	-0.4...+0.4	1.5	574619 
	-1...+1	8	574620 
	-1...+2.5	24	574621 
	-1...+5	60	574622 
	-1...+12	150	574623 
Clamp DN 10/20 according to DIN 32676	-0.4...+0.4	1.5	574624 
	-1...+1	8	574625 
	-1...+2.5	24	574626 
	-1...+5	60	574627 
	-1...+12	150	574628 
G 3/4" flush diaphragm according to ISO 228-1	-0.4...+0.4	1.5	574629 
	-1...+1	8	574630 
	-1...+2.5	24	574631 
	-1...+5	60	574632 
	-1...+12	150	574633 

Further versions on request

**Process connection**

- G ½" according to EN 837
- G ¼" and G ½" according to DIN3852-11
- Clamp DN 25/32/40 (50.5 mm) and clamp DN 50 (64 mm) according to DIN 32676

**Pressure**

- Relative pressure: up to 600 bar or 8700 PSI
- Absolute pressure: up to 100 bar or 1450 PSI

Bürkert – Close to You

For up-to-date addresses
please visit us at
www.burkert.com

DTS 1000416952 EN Version: B Status: RL (released | freigegeben | validé) printed: 17.05.2023

