



### Conductivity sensor for hygienic applications

- Perfect for demanding applications in the hygienic industry (CIP and SIP compatible)
- Wide measuring range thanks to various options available
- Support of the most important process connections ensures specific customer requests can be implemented
- Perfectly suited to the multi-purpose transmitter/controller Type 8619

Product variants described in the data sheet may differ from the product presentation and description.

#### Can be combined with

	<b>Type 8619</b> multiCELL – multi-channel/ multi-function transmitter/ controller	▶
	<b>Type 8200</b> Armatures for analytical sensors	▶
	<b>Type BBS-25</b> Clamp socket, clamps and seals according to DIN 32676	▶

#### Type description

The Type 8221 hygienic conductivity probes are used to determine electrical conductivity in a wide range of pure or concentrated liquids. Due to their hygienic and robust design, these conductivity probes are suitable for use in various application sectors, including the food & beverage, pharmaceutical, biotechnology and chemical industry.

They are available in two technologies, with either 2 or 4 electrodes. Probes based on the 2-electrode principle are intended for use in pure liquids, particularly ultrapure water, as contamination affects the measurement. Probes based on the 4-electrode principle prevent polarisation phenomena and are not sensitive to contamination. The clever design guarantees an excellent linearity over the entire measurement range. All variants are fitted with an integrated temperature sensor (Pt1000) as standard.

The probe has to be connected to the multiCELL transmitter/controller Type 8619.

DTS 1000096134 EN Version: T Status: RL (released | freigegeben | validé) printed: 21.03.2025

## Table of contents

<b>1. General technical data</b>	<b>4</b>
1.1. About the probe.....	4
1.2. 4-electrode conductivity probe .....	4
1.3. 2-electrode conductivity probe .....	5
<b>2. Product variants</b>	<b>6</b>
2.1. 4-electrode conductivity probe .....	6
Four active electrodes positioned laterally on the periphery of the armature .....	6
Four active electrodes positioned at the base of the armature.....	7
2.2. 2-electrode conductivity probe .....	8
<b>3. Approvals and conformities</b>	<b>8</b>
3.1. General notes .....	8
3.2. Conformity .....	8
3.3. Standards.....	8
3.4. Pressure Equipment Directive (PED) .....	9
Device used on a pipe.....	9
Device used on a vessel.....	9
3.5. Foods and beverages/Hygiene .....	9
<b>4. Materials</b>	<b>9</b>
4.1. Bürkert resistApp.....	9
<b>5. Dimensions</b>	<b>10</b>
5.1. 4-electrode conductivity probe with VarioPin electrical connection .....	10
With 1½" clamp process connection.....	10
With 2" clamp process connection.....	11
With 2" (DN 50/40) process connection adapted for GEA Tuchemhagen VARINLINE process connections .....	11
With PG 13.5 process connection.....	12
5.2. 4-electrode conductivity probe with 8-pin M12 male connector .....	12
With 1½" clamp process connection.....	12
5.3. 2-electrode conductivity probe with 5-pin M12 male connector .....	13
With 1½" clamp process connection.....	13
With screw-on process connection .....	13
<b>6. Performance specifications</b>	<b>14</b>
6.1. Linearity diagram .....	14
6.2. Pressure temperature diagram .....	14
<b>7. Product installation</b>	<b>15</b>
7.1. Installation notes .....	15
4-electrode conductivity probe with 1½" clamp or G 1¼" process connection .....	15
4-electrode conductivity probe with PG 13.5 process connection.....	15
2- or 4-electrode conductivity probe with clamp, G or NPT process connection and with M12 connector.....	16
<b>8. Product operation</b>	<b>16</b>
8.1. Measuring principle .....	16
<b>9. Networking and combination with other Bürkert products</b>	<b>17</b>
<b>10. Ordering information</b>	<b>17</b>
10.1. Bürkert eShop .....	17
10.2. Bürkert product filter .....	17

10.3. Ordering chart ..... 18

10.4. Ordering chart accessories..... 18

DTS 1000096134 EN Version: T Status: RL (released | freigegeben | validé) printed: 21.03.2025

## 1. General technical data

### 1.1. About the probe

The probes are based on the 2 or 4 electrode principle. The technical data depends on the probe variant. The common technical data are described in this chapter and further information on the specifics can be found in chapter [“2. Product variants” on page 6](#).

### 1.2. 4-electrode conductivity probe

#### Product properties

##### Material

Make sure the device materials are compatible with the fluid you are using. Further information can be found in chapter [“4.1. Bürkert resistApp” on page 9](#).

Depending on the probe variant.

Further information on the materials can be found in chapter [“2. Product variants” on page 6](#).

Seal	EPDM (conform to FDA - 21CFR177.2600)
Surface quality	Ra < 0.4 µm (15 µin.), electro-polished (wetted metal surfaces)
Dimensions	Further information can be found in chapter <a href="#">“5. Dimensions” on page 10</a> .
Measuring element	4-electrode
Temperature sensor	Pt1000

#### Performance data

Linearity <sup>1)</sup> (relative)	± 0.5...5 %
------------------------------------	-------------

#### Medium data

Fluid temperature	Depending on the probe variant. Further information can be found in chapter <a href="#">“2. Product variants” on page 6</a> .
Fluid pressure	Depending on the probe variant. Further information can be found in chapters <a href="#">“2. Product variants” on page 6</a> and <a href="#">“6.2. Pressure temperature diagram” on page 14</a> .

#### Process/Pipe connection and communication

Process connection	Depending on the probe variant. Further information can be found in chapter <a href="#">“2. Product variants” on page 6</a> .
Electrical connection	Depending on the probe variant. Further information can be found in chapter <a href="#">“2. Product variants” on page 6</a> .

#### Approvals and conformities

##### Directives

CE directive	Further information on the CE Directive can be found in chapter <a href="#">“3.3. Standards” on page 8</a> .
Pressure equipment directive	Complying with article 4, paragraph 1 of 2014/68/EU directive Further information on the pressure equipment directive can be found in chapter <a href="#">“3.4. Pressure Equipment Directive (PED)” on page 9</a> .
Foods and beverages/Hygiene	<ul style="list-style-type: none"> <li>FDA declaration of conformity (only for variant with PEEK armature and EPDM seal)</li> <li>USP class VI declaration</li> </ul> Depending on the probe variant. Further information can be found in chapter <a href="#">“2. Product variants” on page 6</a> .
Materials	Inspection certificate 3.1 Depending on the probe variant. Further information can be found in chapter <a href="#">“2. Product variants” on page 6</a> .
Others	On request: 2-point calibration certificate Depending on the probe variant. Further information can be found in chapter <a href="#">“2. Product variants” on page 6</a> .

#### Environment and installation

Ambient temperature	Depending on the probe variant. Further information can be found in chapter <a href="#">“2. Product variants” on page 6</a> .
Degree of protection according to IEC/EN 60529	IP67, with connected device, inserted and screwed cable plug

1) If only one cell constant is used over the entire range, uncertainties of ± 5 % may occur. If the measured calibration value is close to the measured conductivity value of the solution used, a measurement deviation of ± 0.5 % can be achieved.

### 1.3. 2-electrode conductivity probe

#### Product properties

##### Material

Electrode	Stainless steel 316L/1.4404
Armature	PEEK (conform to FDA - 21CFR 177.2415) and Stainless steel 316L/1.4404
Seal	EPDM (conform to FDA - 21CFR 177.2600)
Surface quality	<ul style="list-style-type: none"> <li>Clamp process connection variant: Ra &lt; 0.4 µm (15 µin.), electro-polished (wetted metal surfaces)</li> <li>Other process connection variants: Ra &lt; 1.6 µm (60 µin.), (wetted metal surfaces)</li> </ul>

Dimensions Further information can be found in chapter ["5. Dimensions" on page 10.](#)

Measuring element 2-electrode

Temperature sensor Pt1000

#### Performance data

##### Conductivity measurement

Linearity<sup>1)</sup> (relative) ± 0.5...5 %

##### Medium data

Fluid temperature - 20...+ 150 °C (- 4...+ 302 °F)

Fluid pressure PN 16 for - 20...+ 120 °C (- 4...+ 248 °F) and PN 10 at 150 °C (302 °F)  
Further information on the fluid pressure can be found in chapter ["6.2. Pressure temperature diagram" on page 14.](#)

#### Process/Pipe connection and communication

Process connection

- 1½" clamp connection
- G 1" connection
- G ¾" connection
- NPT ¾" connection

Electrical connection 5-pin M12 male connector

#### Approvals and conformities

##### Directives

CE directive Further information on the CE Directive can be found in chapter ["3.3. Standards" on page 8.](#)

Pressure equipment directive Complying with Article 4, Paragraph 1 of 2014/68/EU directive  
Further information on the pressure equipment directive can be found in chapter ["3.4. Pressure Equipment Directive \(PED\)" on page 9.](#)

Foods and beverages/Hygiene

- FDA declaration of conformity (only for variant with stainless steel and PEEK armature and EPDM seal)
- USP class VI declaration

Materials Inspection certificate 3.1

Others On request: 2-point calibration certificate

#### Environment and installation

Ambient temperature

- Operation: - 20...+ 150 °C
- Storage: - 10...+ 60 °C

Degree of protection according to IEC/EN 60529 IP67, with connected device, inserted and screwed M12 female cable plug

1.) If only one cell constant is used over the entire range, uncertainties of ± 5 % may occur. If the measured calibration value is close to the measured conductivity value of the solution used, a measurement deviation of ± 0.5 % can be achieved.

## 2. Product variants

### 2.1. 4-electrode conductivity probe

Probes based on the 4-electrode principle are available in two electrode architectures.

#### Four active electrodes positioned laterally on the periphery of the armature



Product properties	
Material	Electrode in stainless steel 1.4435/316L, armature in PEEK (conform to FDA - 21CFR 177.2415) and stainless steel 1.4435/316L
Cell constant <sup>1)</sup>	0.147 cm <sup>-1</sup>
Measuring range	0.1 µS/cm...500 mS/cm
Medium data	
Fluid temperature	-20...+135 °C (-4...+275 °F)
Fluid pressure	Max. 6 bar (87.06 PSI)
Process/Pipe connection and communication	
Process connection	<ul style="list-style-type: none"> <li>In short or long immersion depths:</li> <li>1½" clamp connection</li> <li>G 1¼" process connection (on request)</li> </ul>
Electrical connection	VarioPin male connector (VP 6.0)
Approvals and conformities	
Foods and beverages/Hygiene	ECR1935/2004 declaration
Environment and installation	
Ambient temperature	<ul style="list-style-type: none"> <li>Operation: -20...+135 °C (-4...+275 °F)</li> <li>Storage: +4...+40 °C (+39.2...+104 °F)</li> </ul>

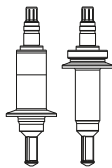

1.) Nominal cell constant. Every product is measured according to internal Bürkert specifications. The individual cell constant is indicated in the calibration protocol supplied with the product and on the label of the product. The cell constant can be influenced by the installation situation.

**Four active electrodes positioned at the base of the armature.**

Two of the electrodes have a flat electrode architecture (measurement electrodes), while the other two electrodes are conical (excitation electrodes).



Product properties	
Material	Electrode in stainless steel 1.4435/316L <sup>1)</sup> and armature in PEEK (conform to FDA - 21CFR 177.2415) and stainless steel 1.4435/316L
Cell constant <sup>2)</sup>	0.36 cm <sup>-1</sup>
Measuring range	1 µS/cm...300 mS/cm
Medium data	
Fluid temperature	- 20...+ 150 °C (- 4...+ 302 °F)
Fluid pressure	Max. 20 bar (290.2 PSI) for - 20...+ 135 °C (- 4...+ 275 °F) and max. 10 bar (145.1 PSI) at 150 °C (302 °F)
Process/Pipe connection and communication	
Process connection	<ul style="list-style-type: none"> <li>• 2" clamp connection</li> <li>• 2" (DN 50/40) connection adapted for GEA Tuchenhagen VARINLINE</li> <li>• PG 13.5 connection</li> </ul>
Electrical connection	VarioPin male connector (VP 6.0)
Approvals and conformities	
Foods and beverages/Hygiene	ECR1935/2004 declaration
Environment and installation	
Ambient temperature	<ul style="list-style-type: none"> <li>• Operation: - 20...+ 150 °C (- 4...+ 302 °F)</li> <li>• Storage: + 4...+ 40 °C (+ 39.2...+ 104 °F)</li> </ul>

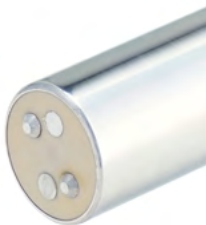
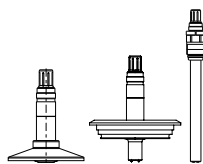

Product properties	
Material	Electrode in stainless steel 316L/1.4404 and armature in PEEK (conform to FDA - 21CFR 177.2415) and stainless steel 316L/1.4404
Cell constant <sup>2)</sup>	0.33 cm <sup>-1</sup>
Measuring range	1 µS/cm...20 mS/cm
Performance data	
Temperature measurement	
Response time (t <sub>90</sub> )	120 s
Medium data	
Fluid temperature	- 20...+ 150 °C (- 4...+ 302 °F)
Fluid pressure	PN 16 for - 20...+ 120 °C (- 4...+ 248 °F) and PN 10 at 150 °C (302 °F)
Process/Pipe connection and communication	
Process connection	1½" clamp connection
Electrical connection	8-pin M12 male connector
Environment and installation	
Ambient temperature	<ul style="list-style-type: none"> <li>• Operation: - 20...+ 150 °C</li> <li>• Storage: - 10...+ 60 °C</li> </ul>



1.) Other materials are available on request.

2.) Nominal cell constant. Every product is measured according to internal Bürkert specifications. The individual cell constant is indicated in the calibration protocol supplied with the product and on the label of the product. The cell constant can be influenced by the installation situation.

## 2.2. 2-electrode conductivity probe

Probes based on the 2-electrode principle are available in two electrode architectures:



The hole is located 19 mm from the base of the armature. The electrode spacing is short and the inner electrode has a large cross-section area.

Product properties	
Cell constant <sup>1)</sup>	0.01 cm <sup>-1</sup>
Measuring range	0.05...20 µS/cm
Performance data	
Temperature measurement	
Response time (t <sub>90</sub> )	60 s

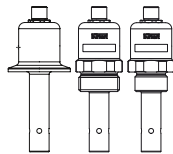

The hole is located 11 mm from the base of the armature. The electrode spacing is large and the inner electrode has a small cross-section area.

Product properties	
Cell constant <sup>1)</sup>	0.1 cm <sup>-1</sup>
Measuring range	1...200 µS/cm
Performance data	
Temperature measurement	
Response time (t <sub>90</sub> )	100 s

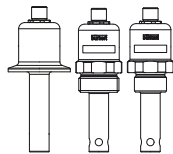

1.) Nominal cell constant. Every product is measured according to internal Bürkert specifications. The individual cell constant is indicated in the calibration protocol supplied with the product and on the label of the product. The cell constant can be influenced by the installation situation.

## 3. Approvals and conformities

### 3.1. General notes

- The approvals and conformities listed below must be stated when making enquiries. This is the only way to ensure that the product complies with all required specifications.
- Not all available variants of the device can be supplied with the below mentioned approvals or conformities.

### 3.2. Conformity

In accordance with the Declaration of Conformity, the product is compliant with the EU Directives.

### 3.3. Standards

The applied standards which are used to demonstrate compliance with the EU Directives are listed in the EU-Type Examination Certificate and/or the EU Declaration of Conformity.



### 3.4. Pressure Equipment Directive (PED)

The device conforms to article 4, paragraph 1 of the Pressure Equipment Directive (PED) 2014/68/EU under the following conditions:

#### Device used on a pipe

**Note:**

- The data in the table is independent of the chemical compatibility of the material and the fluid.
- PS = maximum admissible pressure (in bar), DN = nominal diameter of the pipe

Type of fluid	Conditions
Fluid group 1, Article 4, Paragraph 1.c.i	DN ≤ 25
Fluid group 2, Article 4, Paragraph 1.c.i	DN ≤ 32 or PS*DN ≤ 1000
Fluid group 1, Article 4, Paragraph 1.c.ii	DN ≤ 25 or PS*DN ≤ 2000
Fluid group 2, Article 4, Paragraph 1.c.ii	DN ≤ 200 or PS ≤ 10 or PS*DN ≤ 5000

#### Device used on a vessel

**Note:**

- The data in the table is independent of the chemical compatibility of the material and the fluid.
- PS = maximum admissible pressure, V = vessel volume

Type of fluid	Conditions
Fluid group 1, Article 4, Paragraph 1.a.i	V > 1 L and PS*V ≤ 25 bar.L or PS ≤ 200 bar
Fluid group 2, Article 4, Paragraph 1.a.i	V > 1 L and PS*V ≤ 50 bar.L or PS ≤ 1000 bar
Fluid group 1, Article 4, Paragraph 1.a.ii	V > 1 L and PS*V ≤ 200 bar.L or PS ≤ 500 bar
Fluid group 2, Article 4, Paragraph 1.a.ii	PS > 10 bar and PS*V ≤ 10000 bar.L or PS ≤ 1000 bar

### 3.5. Foods and beverages/Hygiene

Conformity	Description
FDA	<b>FDA – Code of Federal Regulations</b> The devices with the housing made of PEEK materials and the seal made of EPDM materials are compliant in their composition with the Code of Federal Regulations published by the FDA (Food and Drug Administration, USA) according to the manufacturer's declaration.
USP	<b>United States Pharmacopeial Convention (USP)</b> The devices with the housing made of PEEK materials and the seal made of EPDM materials are biocompatible according to the manufacturer's declaration.
	<b>EC Regulation 1935/2004 of the European Parliament and of the Council</b> The devices with the housing made of PEEK materials and the seal made of EPDM materials are compliant with EC Regulation 1935/2004 according to the manufacturer's declaration.

## 4. Materials

### 4.1. Bürkert resistApp

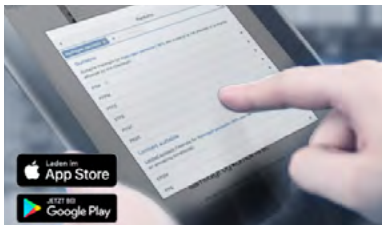

**Bürkert resistApp – Chemical resistance chart**

You want to ensure the reliability and durability of the materials in your individual application case? Verify your combination of media and materials on our website or in our resistApp.

Start chemical resistance check

DTS 1000096134 EN Version: T Status: RL (released | freigegeben | validé) printed: 21.03.2025

## 5. Dimensions

### 5.1. 4-electrode conductivity probe with VarioPin electrical connection

With 1½" clamp process connection

**Note:**

Dimensions in mm, unless otherwise stated

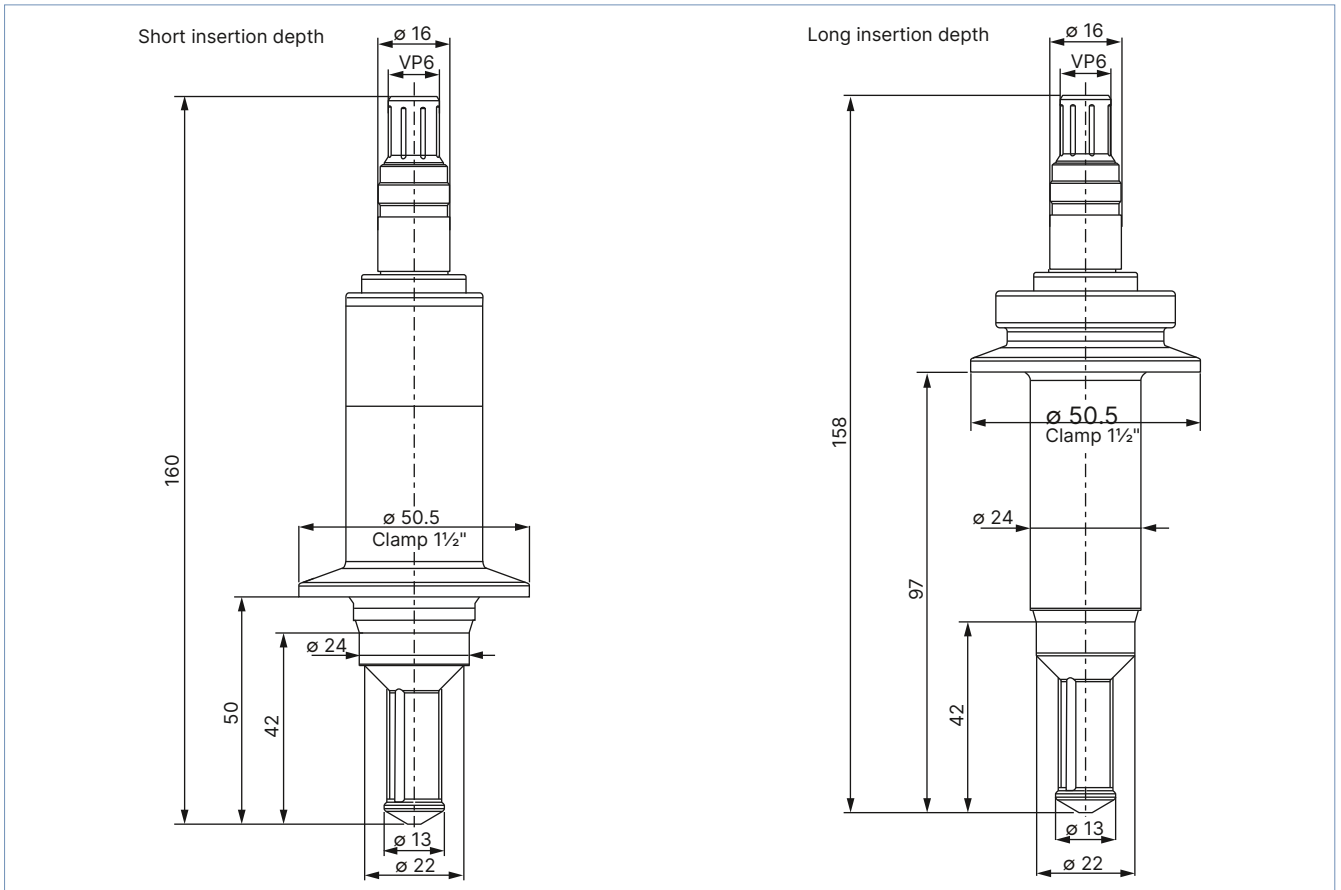

**With 2" clamp process connection**

**Note:**

Dimensions in mm, unless otherwise stated

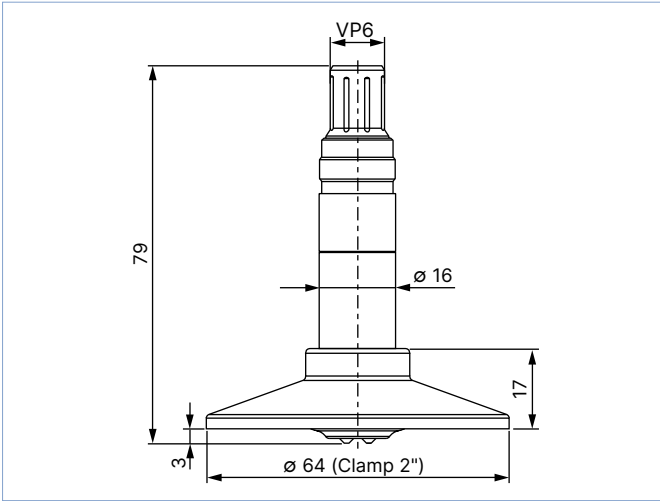

**With 2" (DN 50/40) process connection adapted for GEA Tuchenhagen VARINLINE process connections**

**Note:**

Dimensions in mm, unless otherwise stated

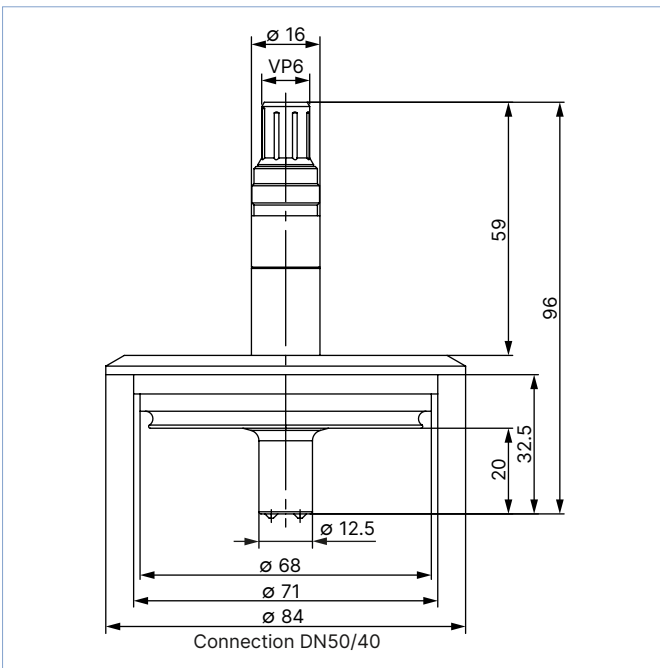

**With PG 13.5 process connection**

**Note:**

Dimensions in mm, unless otherwise stated

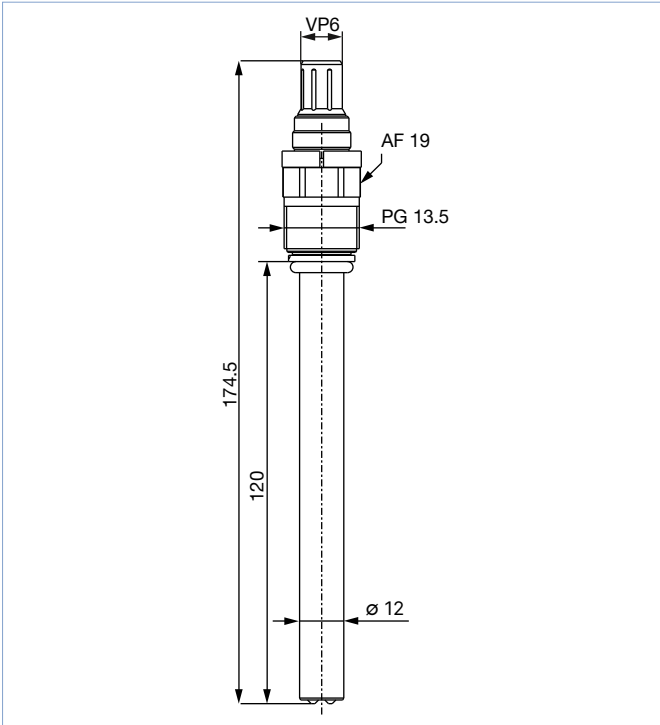

**5.2. 4-electrode conductivity probe with 8-pin M12 male connector**

**With 1½" clamp process connection**

**Note:**

Dimensions in mm, unless otherwise stated

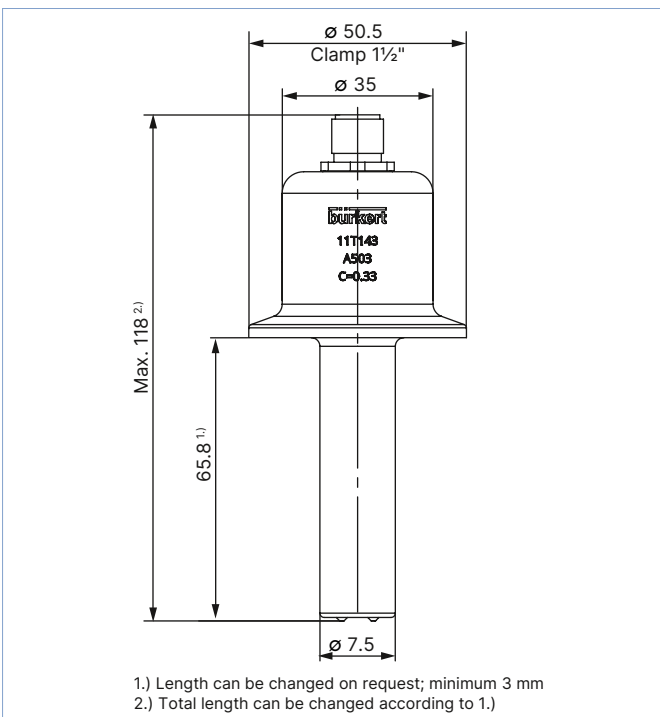

DTS 1000096134 EN Version: T Status: RL (released | freigegeben | validé) printed: 21.03.2025

**5.3. 2-electrode conductivity probe with 5-pin M12 male connector**

**With 1½" clamp process connection**

**Note:**

Dimensions in mm, unless otherwise stated

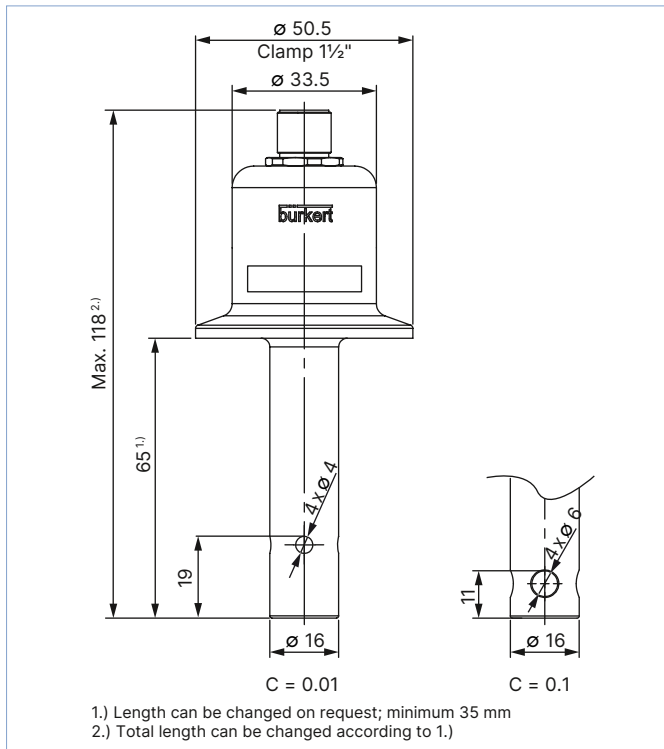

**With screw-on process connection**

**Note:**

Dimensions in mm, unless otherwise stated

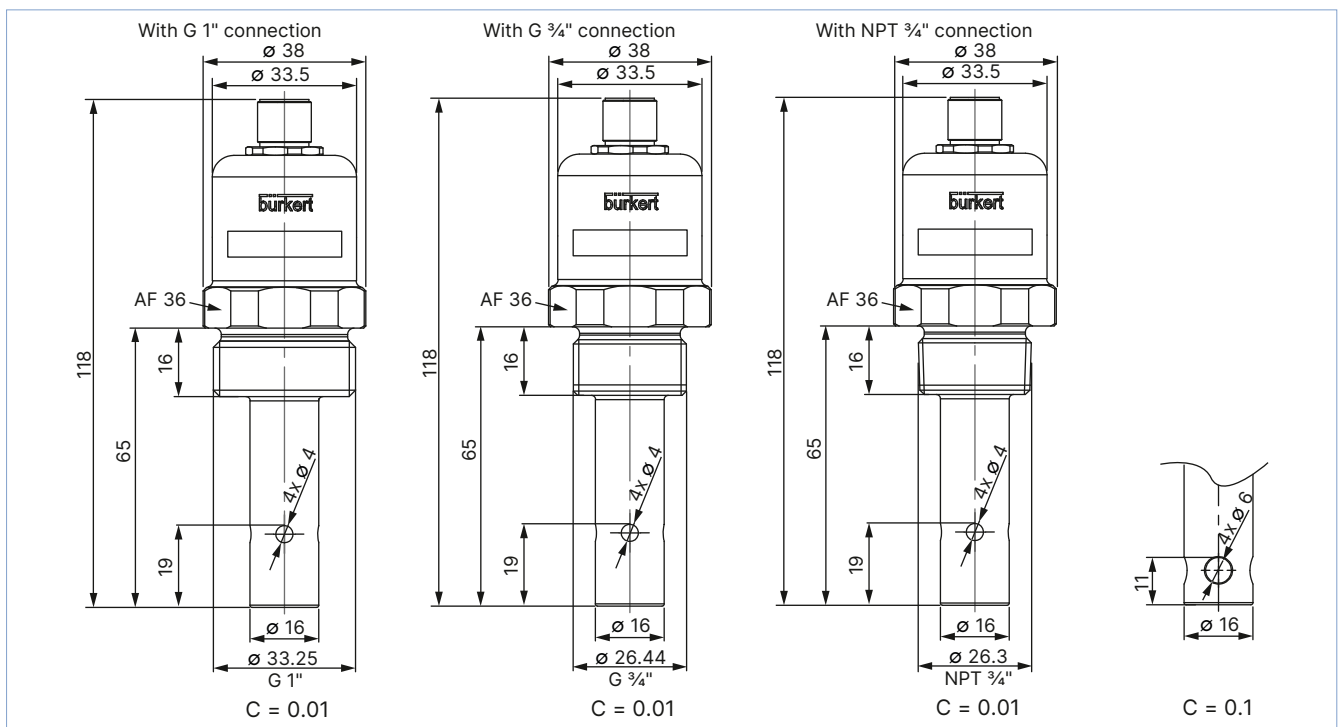

## 6. Performance specifications

### 6.1. Linearity diagram

**Note:**

The following table only applies to conductivity probes based on the 4-electrode principle with VarioPin (VP 6.0) electrical connection.

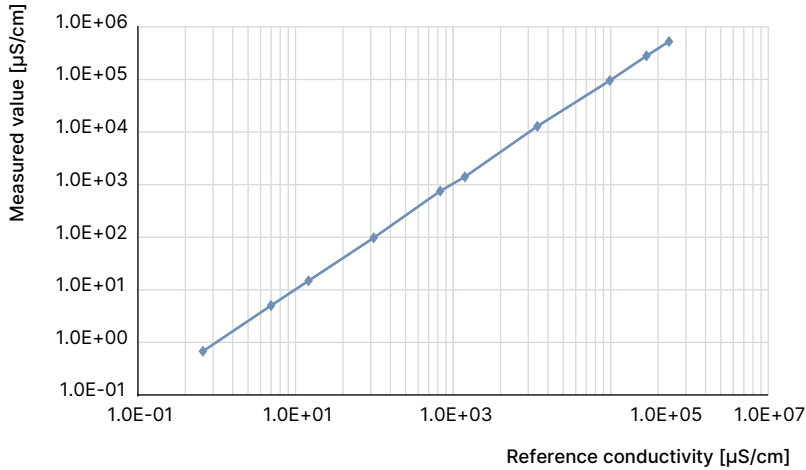

### 6.2. Pressure temperature diagram

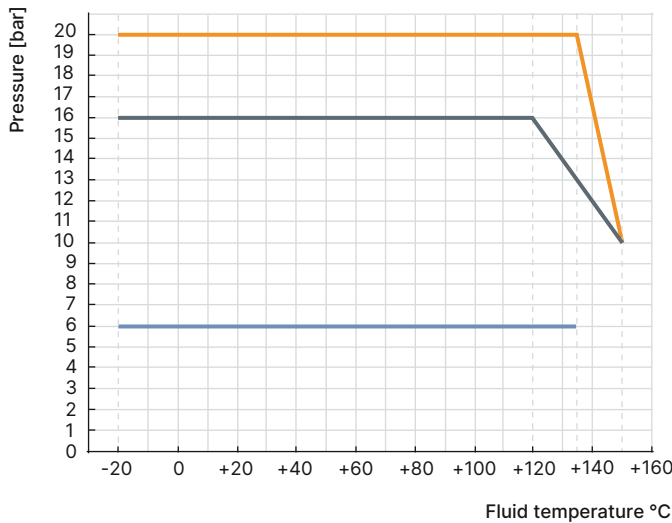

Application range for conductivity probe

- 2 or 4 electrodes, 1½" clamp connection, G 1", G ¾" or NPT ¾" connection variant with M12 connector
- 4 electrodes, G 1¼" and 1½" clamp connection (short/long)
- 4 electrodes, 2" clamp connection, 2" (DN50/40) adapted for GEA Tuchenhagen VARINLINE devices and PG 13.5 connection

DTS 1000096134 EN Version: T Status: RL (released | freigegeben | validé) printed: 21.03.2025

## 7. Product installation

### 7.1. Installation notes

#### 4-electrode conductivity probe with 1½" clamp or G 1¼" process connection

**Note:**

- The process connection must be sufficiently clean.
- Install the conductivity probe according to the instructions below.

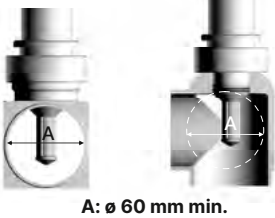
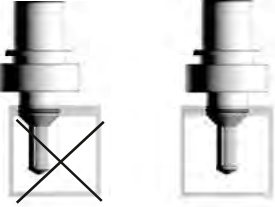

Installation example	Description
 <p>A: ø 60 mm min.</p>	<p>The cell constant and the linearity of the probe can vary with the fitting situation.</p> <ul style="list-style-type: none"> <li>• A symmetrical setup is recommended.</li> <li>• Leave a minimum space of 60 mm minimum diameter.</li> <li>• Partitions made of non-conductive material should preferably be used.</li> </ul>
	<p>A symmetrical setup is recommended in order to ensure a high linearity.</p> <ul style="list-style-type: none"> <li>• To achieve high precision the cell constant should be calibrated in the final setup.</li> <li>• Make sure that all the 4 electrodes are completely and continuously immersed in the measuring sample.</li> </ul>

#### 4-electrode conductivity probe with PG 13.5 process connection

**Note:**

- To install the conductivity probe in a T-fitting or in a pipe, use a hygienic probe holder Type 8200.
- Observe a distance of 10 mm around the tip of the electrode.

See [data sheet Type 8200](#) ▶ for more information.

	<p>The conductivity probe PG 13.5 is installed in a hygienic direct welded probe holder Type 8200 without adapter.</p>
	<p>The conductivity probe PG 13.5 is installed in a hygienic direct welded probe holder Type 8200 with adapter.</p>

DTS 1000096134 EN Version: T Status: RL (released | freigegeben | validé) printed: 21.03.2025

**2- or 4-electrode conductivity probe with clamp, G or NPT process connection and with M12 connector**

**Note:**

- Mount the probe in a 1½" T fitting made of stainless steel or alternatively in an orifice with a suitable thread, taking into account the entire length of the thread and the depth of the insertion of the prob, as shown below.
- The drawing shows the assembly with a process clamp connection. This also applies to a G or NPT process connection.

Installation examples		Description
<p>Probe with C = 0.01</p>	<p>Probe with C = 0.1</p>	<ul style="list-style-type: none"> <li>• Align the probe hole as closely as possible with the centre of T fitting outlet.</li> <li>• Make sure that the line is thoroughly flushed of its air during the filling</li> </ul>

**8. Product operation**

**8.1. Measuring principle**

Conductivity is defined by the property of a solution to conduct electrical current. The charge carriers are ions (e.g. dissolved salts or acids).

In the simplest case the measurement cell consists of two metal electrodes which are set at a fixed distance apart and with a known specified surface. An AC voltage supplied from the connected transmitter/controller Type 8619 is applied to the electrodes. The measured current is a direct function of the quantity of ions contained in the solution, and with help of Ohm's law the conductivity is calculated.

The 4-electrode probe consists of two current and two voltage electrodes. Between the two current electrodes, an AC electric current flows, which is regulated by the transmitter/controller Type 8619. With the two voltage electrodes a resulting AC voltage drop is measured across the sample. The voltage drop depends on the conductivity of the sample. As a result of this measurement principle, 4 electrode sensors have a much broader linear measurement range, are insensitive to contamination and polarisation effects by adjusting the frequency of the AC current.

There are countless types of conductivity probes whose measurement values vary by a great margin - depending on the electrode assembly. To compensate for the geometry of the conductivity cell a cell constant is used:  $\text{Conductivity [S/cm]} = \text{Measurement [S]} \times \text{Cell constant [1/cm]}$ .

The cell constant is either known or it is determined by means of conductivity standards, and has to be entered into the transmitter prior to measurement.

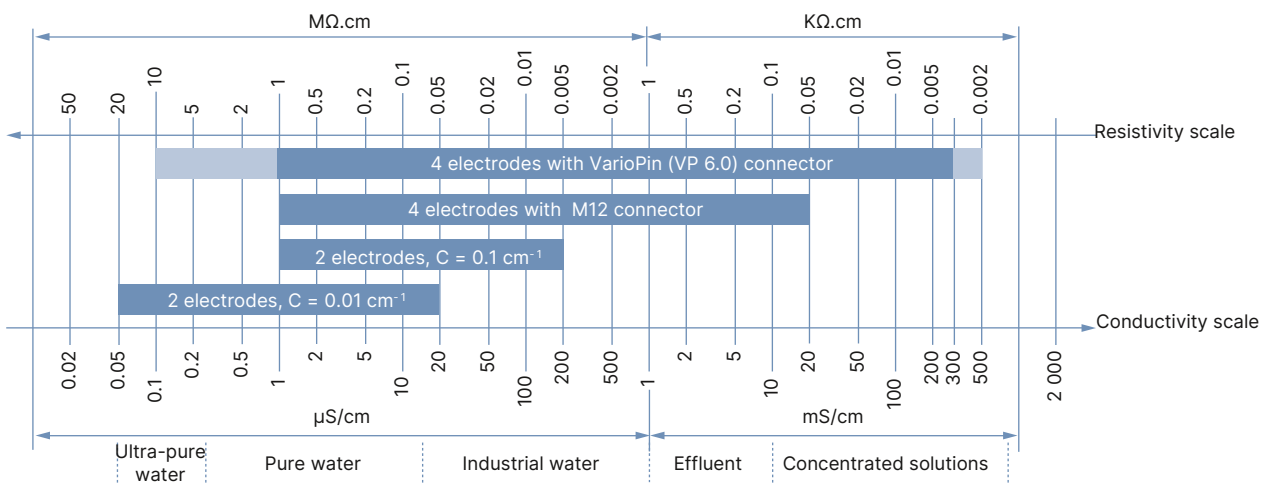

DTS 1000096134 EN Version: T Status: RL (released | freigegeben | valide) printed: 21.03.2025



## 9. Networking and combination with other Bürkert products

Example:

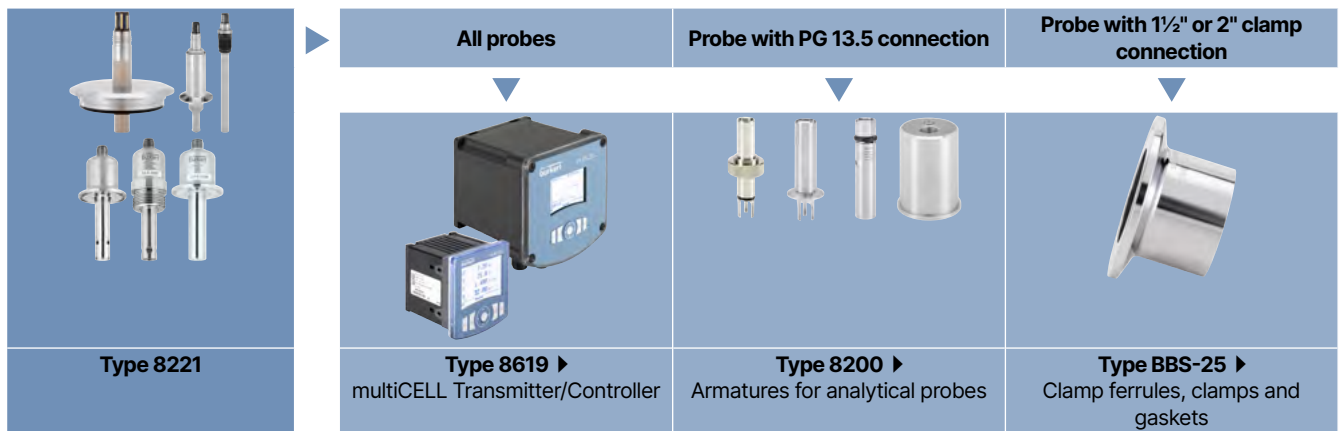

## 10. Ordering information

### 10.1. Bürkert eShop



**Bürkert eShop – Easy ordering and quick delivery**

You want to find your desired Bürkert product or spare part quickly and order directly? Our online shop is available for you 24/7. Sign up and enjoy all the benefits.

[Order online now](#)

### 10.2. Bürkert product filter

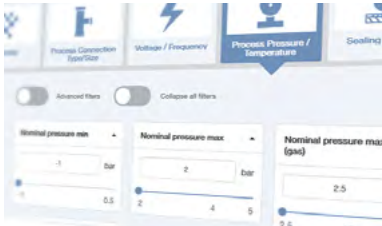















**Bürkert product filter – Get quickly to the right product**

You want to select products comfortably based on your technical requirements? Use the Bürkert product filter and find suitable articles for your application quickly and easily.

[Try out our product filter](#)

DTS 1000096134 EN Version: T Status: RL (released | freigegeben | valide) printed: 21.03.2025

### 10.3. Ordering chart

Cell constant [cm <sup>-1</sup> ]	Measuring range [μS/cm]	Process connection	Probe	Approval and conformity			Electrical connection	Article no.
				FDA	USP class VI	ECR 1935/2004		
<b>Conductivity probe 4-electrode</b>								
0.147	0.1...500 000	1½" clamp	Short	Yes	Yes	Yes	VarioPin (VP 6.0)	562420 
			Long					564064 
0.36	1...300 000	2" clamp	-					559120 
		2" (DN 50/40) adapted for GEA Tuchenhagen VARINLINE						563269 
		PG 13.5						563186 
0.33	1...20 000	1½" clamp				No	8-pin M12 male connector	571162 
<b>Conductivity probe 2-electrode</b>								
0.01	0.05...20	1½" clamp	-	Yes	Yes	No	5-pin M12 male connector	568818 
		G 1"						569644 
		G ¾"						570452 
		NPT ¾"						570454 
0.1	1...200	1½" clamp						569643 
		G 1"						569645 
		G ¾"						570453 
		NPT ¾"						570455 





















#### Further versions on request



#### Process connection

Others...e.g. G 1¼"

### 10.4. Ordering chart accessories

Description	Article no.
EPDM seal for measuring device with G ¾" external threaded process connection	561955 
EPDM seal for measuring device with 1½" clamp process connection	730277 
FKM seal for measuring device with 1½" clamp process connection	730285 
EPDM seal for measuring device with 2" clamp process connection	730289 
FKM seal for measuring device with 2" clamp process connection	730299 
M12 female connector with plastic threaded clamping ring, 5-pin, straight, to be wired	917116 
M12 female connector with moulded cable (shielded), 5-pin, straight, cable length: 2 m	438680 
M12 female connector with moulded cable (shielded), 5-pin, straight, cable length: 5 m	560365 
M12 female connector with moulded cable (shielded), 5-pin, straight, cable length: 10 m	563108 
M12 female connector with metal threaded clamping ring, 8-pin, straight, to be wired	918998 
8-pin M12 straight female connector moulded on cable (2 m)	444800 
8-pin M12 straight female connector moulded on cable (10 m)	555675 
Connection cable with VarioPin female connector (VP 6.0) and open strand ends with wire end sleeves, cable length: 3 m	554855 
Connection cable with VarioPin female connector (VP 6.0) and open strand ends with wire end sleeves, cable length: 5 m	554856 
Connection cable with VarioPin female connector (VP 6.0) and open strand ends with wire end sleeves, cable length: 10 m	554857 
Buffer solution, 300 ml, conductivity standard: 5 μS/cm, ± 1 % accuracy	440015 
Buffer solution, 300 ml, conductivity standard: 15 μS/cm, ± 5 % accuracy	440016 
Buffer solution, 300 ml, conductivity standard: 100 μS/cm, ± 3 % accuracy	440017 
Buffer solution, 300 ml, conductivity standard: 706 μS/cm, ± 2 % accuracy	440018 
Buffer solution, 300 ml, conductivity standard: 1413 μS/cm, ± 1 % accuracy	440019 
Buffer solution, 300 ml, conductivity standard: 100 mS/cm, ± 1 % accuracy	440020 