







## Holder for analysis probes

- For many different types of installations and applications
- Large range of sensor holders
- General purpose and pharmaceutical applications, water treatment, food & beverage industry

Product variants described in the data sheet may differ from the product presentation and description.

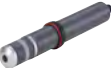
### Can be combined with

	<b>Type 8203</b> pH- and ORP-probes	▶
	<b>Type 8221</b> Conductivity sensor for hygienic applications	▶
	<b>Type 8232</b> Chlorine sensor	▶
	<b>Type S020</b> Insertion fitting for volume flow rate or analysis measurements	▶
	<b>Type BBS-25</b> Clamp socket, clamps and seals according to DIN 32676	▶

### Type description

The holder product range allows the installation of 120 mm long analysis probes (pH/redox potential (ORP)/conductivity) or chlorine sensors etc., on a tank or process pipelines and covers general-purpose applications as well as water treatment, food & beverage and pharmaceutical applications.

This product range includes a variety of process fittings for general-purpose holders (with or without protective rods) , hygienic holders (with or without protective rods or protective tube), as well as transparent one-piece holders, so-called analysis measurement chambers, designed for multiple measurements.

Depending on the variant, these analysis measurement chambers can accommodate one or multiple probes and sensors.

Depending on the variant, the holder allows for steam sterilisation, autoclaving, cleaning in place (CIP), space optimization, positioning of the probe according to the medium flow , and installation in vertical pipes. It can also be equipped with a Pt1000 temperature sensor.

The analysis measurement chambers are available for specific integration into the process. Due to their transparent surface, they allow visualisation of the liquid flow and ensure optimum measuring conditions.

The single-slot analysis measurement chamber is designed for use with the Type 8232 chlorine sensor. The analysis measurement chambers with three or four slots allow the simultaneous measurement of several parameters such as chlorine, temperature, pH, ORP or conductivity. Two of the slots are always reserved for temperature and chlorine sensors, while the others are intended for additional analysis probes. The three-slot analysis measurement chamber is available in variant for either cold or hot water.

## Table of contents

<b>1. General technical data</b>	<b>4</b>
1.1. About the device.....	4
1.2. All variants.....	4
<b>2. Product variants</b>	<b>5</b>
2.1. General purpose holder .....	5
G 2" connection .....	5
G 1" or solvent union connection .....	5
2.2. Hygienic purpose holder .....	6
G 1¼" connection (28 or 46 mm O-ring position).....	6
1½" clamp (Ø 50.5 mm) connection, short immersion depth.....	6
1½" clamp (Ø 50.5 mm) connection, long immersion depth.....	6
2" (DN 50/40) connection adapted for GEA Tuchenhagen VARINLINE process connections.....	7
2.3. Analysis measurement chamber .....	7
With one sensor slot for chlorine measurement .....	7
With three sensor slots for chlorine, temperature and one other analysis measurements .....	8
With four sensor slots for chlorine, temperature and two other analysis measurements.....	8
<b>3. Approvals and conformities</b>	<b>8</b>
3.1. General notes .....	8
3.2. Conformity .....	8
3.3. Standards.....	9
3.4. Pressure Equipment Directive (PED) .....	9
Device used on a pipe.....	9
Device used on a vessel.....	9
3.5. Foods and beverages/Hygiene.....	9
<b>4. Materials</b>	<b>10</b>
4.1. Bürkert resistApp.....	10
<b>5. Dimensions</b>	<b>10</b>
5.1. General purpose holder .....	10
G 2" connection .....	10
G 1" connection.....	11
Solvent union connection.....	11
5.2. Hygienic holder .....	12
G 1¼" connection (28 or 46 mm O-ring position).....	12
1½" clamp connection (Ø 50.5 mm), short immersion depth.....	12
1½" clamp connection (Ø 50.5 mm), long immersion depth.....	13
2" (DN 50/40) connection adapted for GEA Tuchenhagen VARINLINE process connections.....	13
5.3. Analysis measurement chamber .....	14
With one sensor slot for chlorine measurement .....	14
With three sensor slots for chlorine, temperature and one other analysis measurements .....	15
With four sensor slots for chlorine, temperature and two other analysis measurements.....	16
<b>6. Product installation</b>	<b>17</b>
6.1. Installation notes .....	17
General purpose holder with G 2" connection for installation on Type S020 Bürkert fitting.....	17
General purpose holder with G 1" or solvent connection for installation on T-fitting.....	17
Hygienic holder with G 1¼" connection and O-ring position of 28 or 46 mm for installation on sockets.....	17
Analysis measurement chamber .....	18
<b>7. Networking and combination with other Bürkert products</b>	<b>21</b>
7.1. Combination of general purpose holder with G 2" connection for installation on S020 Bürkert fitting.....	21

DTS 1000141421 EN Version: AB Status: RL (released | freigegeben | valide) printed: 20.05.2026

- 7.2. Combination with available Type S020 Insertion fittings DN ..... 21
- 7.3. Combination of general purpose with G 1", solvent connection or hygienic holders .....22
- 7.4. Combination of the analysis measurement chamber .....23

**8. Ordering information 24**

- 8.1. Bürkert eShop .....24
- 8.2. Recommendation regarding product selection.....24
  - General purpose or hygienic holders for pH/ORP/conductivity measurement for tank or pipe installation .....24
  - Analysis measurement chamber .....24
- 8.3. Bürkert product filter .....25
- 8.4. Ordering chart .....25
  - General purpose or hygienic holders for pH/ORP/conductivity measurement for tank or pipe installation .....25
  - Analysis measurement chamber .....26
- 8.5. Ordering chart accessories.....26

DTS 1000141421 EN Version: AB Status: RL (released | freigegeben | valide) printed: 20.05.2026

## 1. General technical data

### 1.1. About the device

These holders are used in combination with 120 mm analysis probes for general or hygienic purposes. These must be equipped with either a Bürkert pH- or ORP-probe Type 8203 or a conductivity probe Type 8221. The special analysis measurement chamber must be used with the chlorine sensor Type 8232.

See [data sheet Type 8203](#) ▶, [data sheet Type 8221](#) ▶ or [data sheet Type 8232](#) ▶ for more information.

### 1.2. All variants

#### Product properties

##### Material

Make sure the device materials are compatible with the fluid you are using. Further information can be found in chapter [“4.1. Bürkert resistApp” on page 10](#).

Depending on the holder version. Further information on the materials can be found in chapter [“2. Product variants” on page 5](#).

#### Medium data

Fluid temperature	Depending on the holder version Further information can be found in chapter <a href="#">“2. Product variants” on page 5</a> . Temperature limits may depend on the inserted probe. Refer to the relevant operating instructions and data sheet of the probe. If the temperature ranges given for the holder and the inserted probe are different, use the most restrictive range.
-------------------	--

Fluid pressure	Depending on the holder version Further information can be found in chapter <a href="#">“2. Product variants” on page 5</a> . Pressure limits may depend on the inserted probe. Refer to the relevant operating instructions and data sheet of the probe. If the pressure ranges given for the holder and the inserted probe are different, use the most restrictive range.
----------------	--

#### Produktanschlüsse

- |                    |   |
|--------------------|---|
| Process connection | <ul style="list-style-type: none"> <li>• General purpose holder                         <ul style="list-style-type: none"> <li>– G 2" for use with Type S020 Insertion fitting</li> <li>– G 1" for use with T-fitting</li> <li>– Solvent union for use with T-fitting d32 x d32 up to d32 x d110</li> </ul> </li> <li>• Hygienic holder                         <ul style="list-style-type: none"> <li>– G 1¼" (28 or 46 mm O-ring position)</li> <li>– Clamp 1½" (Ø 50.5 mm)</li> <li>– 2" (DN 50/40) connection adapted for GEA Tuchenhagen VARINLINE process connections</li> </ul> </li> <li>• Analysis measurement chamber                         <ul style="list-style-type: none"> <li>– Straight ¼" screw-in connections for hose 6/8 (for inlet and outlet) with O-ring, mounting nut (to fasten the sensor) and hose sleeve (to sample)</li> </ul> </li> </ul> |
|--------------------|---|

#### Approvals and conformities

##### Directives

Pressure equipment directive	Complying with article 4, paragraph 1 of 2014/68/EU directive Further information on the pressure equipment directive can be found in chapter <a href="#">“3.4. Pressure Equipment Directive (PED)” on page 9</a> .
------------------------------	--

#### Environment and installation

Ambient temperature	Temperature limits may depend on the inserted probe. Further information can be found in the relevant operating instructions and data sheet of the probe.
---------------------	--

DTS 1000141421 EN Version: AB Status: RL (released | freigegeben | valide) printed: 20.05.2026

## 2. Product variants

### 2.1. General purpose holder

#### G 2" connection



This holder is always equipped with protection rods, and is available with or without boring for a Pt1000 temperature probe/liquid earthing pin. It is designed for use with Insertion fitting, Type S020. Further information can be found in the [data sheet Type S020](#) ►.

Product properties	
Material	<ul style="list-style-type: none"> <li>• Body in PVC or stainless steel (316L/1.4404)</li> <li>• Seal in FKM (EPDM optional)</li> </ul>
Dimensions	Further information can be found in chapter " <a href="#">G 2" connection</a> " on page 10.
Medium data	
Fluid temperature	With Type S020 fitting in: <ul style="list-style-type: none"> <li>• PVC: 0...+ 50 °C (+ 32...+ 122 °F)</li> <li>• Stainless steel: - 20...+ 130 °C (+ 5...+ 266 °F)</li> </ul>
Fluid pressure.	With Type S020 fitting in: <ul style="list-style-type: none"> <li>• PVC: max. PN 10 (145 PSI)</li> <li>• Stainless steel: max. PN 16 (232 PSI)</li> </ul>

#### G 1" or solvent union connection



This holder has no protection rod, but is available with or without boring for a Pt1000 temperature probe/liquid earthing pin.

Product properties	
Material	<ul style="list-style-type: none"> <li>• Body in PVC</li> <li>• Seal in FKM</li> </ul>
Dimensions	Further information can be found in chapter " <a href="#">G 1" connection</a> " on page 11 or " <a href="#">Solvent union connection</a> " on page 11.
Medium data	
Fluid temperature	0...+ 50 °C (+ 32...+ 176 °F)
Fluid pressure	Max. PN 10 (145 PSI)

## 2.2. Hygienic purpose holder

### G 1¼" connection (28 or 46 mm O-ring position)



This support, equipped with 3 rods ensuring a good protection of the sensor, allows an easy cleaning. Thanks to its sanitary design, steam sterilisation, autoclaving and CIP cleaning are possible.

Product properties	
Material	<ul style="list-style-type: none"> <li>• Body in stainless steel (316L/1.4435) (316Ti/1.4571 on request)</li> <li>• Seal in EPDM (FKM or PTFE on request)</li> </ul>
Surface quality	Ra < 0.4 µm (15 µin.) electro-polished
Dimensions	Further information can be found in chapter "G 1¼" connection (28 or 46 mm O-ring position)" on page 12.
Medium data	
Fluid temperature	- 10...+ 135 °C (+ 14...+ 275 °F)
Fluid pressure	Max. 6 bar (87 PSI)
Approvals and conformities	
Foods and beverages/ Hygiene	<ul style="list-style-type: none"> <li>• USP class VI declaration</li> <li>• FDA declaration of conformity</li> </ul>
Materials	<ul style="list-style-type: none"> <li>• Inspection certificate 3.1</li> <li>• On request: certification of conformity for the surface quality</li> </ul>

### 1½" clamp (Ø 50.5 mm) connection, short immersion depth



This support, equipped with 3 rods ensuring a good protection of the sensor, allows an easy cleaning. Thanks to its sanitary design, steam sterilisation, autoclaving and CIP cleaning are possible.

Product properties	
Material	<ul style="list-style-type: none"> <li>• Body in stainless steel (316L/1.4435)</li> <li>• Seal in EPDM</li> </ul>
Surface quality	Ra < 0.4 µm (15 µin.) electro-polished
Dimensions	Further information can be found in chapter "1½" clamp connection (Ø 50.5 mm), short immersion depth" on page 12.
Medium data	
Fluid temperature	- 10...+ 135 °C (+ 14...+ 275 °F)
Fluid pressure	Max. 6 bar (87 PSI)
Approvals and conformities	
Foods and beverages/ Hygiene	<ul style="list-style-type: none"> <li>• USP class VI declaration</li> <li>• FDA declaration of conformity</li> <li>• ECR1935/2004 declaration</li> </ul>
Materials	<ul style="list-style-type: none"> <li>• Inspection certificate 3.1</li> <li>• On request: certification of conformity for the surface quality</li> </ul>

### 1½" clamp (Ø 50.5 mm) connection, long immersion depth



This support, equipped with a tube ensuring a good protection of the sensor, allows an easy cleaning. Thanks to its sanitary design, steam sterilisation, autoclaving and CIP cleaning are possible.

Product properties	
Material	<ul style="list-style-type: none"> <li>• Body in stainless steel (316L/1.4404)</li> <li>• Seal in FKM</li> </ul>
Surface quality	Ra < 1.6 µm (63 µin.)
Dimensions	Further information can be found in chapter "1½" clamp connection (Ø 50.5 mm), long immersion depth" on page 13.
Medium data	
Fluid temperature	- 10...+ 135 °C (+ 14...+ 275 °F)
Fluid pressure	Max. 6 bar (87 PSI)

**2" (DN 50/40) connection adapted for GEA Tuchenhagen VARINLINE process connections**



This 15° variant support enables the probe to be positioned in relation to the flow direction or to be mounted in vertical pipes.

Product properties	
Material	<ul style="list-style-type: none"> <li>• Body in stainless steel (316L/1.4435)</li> <li>• Seal in EPDM</li> </ul>
Surface quality	Ra < 0.4 µm (15 µin.)
Dimensions	Further information can be found in chapter <b>"2" (DN 50/40) connection adapted for GEA Tuchenhagen VARINLINE process connections</b> on page 13.
Medium data	
Fluid temperature	-10...+135 °C (+14...+275 °F)
Fluid pressure	Max. 6 bar (87 PSI)
Approvals and conformities	
Foods and beverages/ Hygiene	<ul style="list-style-type: none"> <li>• USP class VI declaration</li> <li>• FDA declaration of conformity</li> <li>• ECR1935/2004 declaration</li> </ul>
Materials	<ul style="list-style-type: none"> <li>• Inspection certificate 3.1</li> <li>• On request: certification of conformity for the surface quality</li> </ul>

**2.3. Analysis measurement chamber**

**With one sensor slot for chlorine measurement**



This holder is designed for use with the chlorine sensor, Type 8232. Further information can be found in the **data sheet Type 8232** ►.

Product properties	
Material	<ul style="list-style-type: none"> <li>• Body in PMMA polished, bevelled edges</li> <li>• Mounting union nut in PVC grey</li> <li>• O-ring holder in PVC grey</li> <li>• Slide ring (30 × 25.5 × 4) in PETP black</li> <li>• Hose connection in PA grey</li> <li>• Inlet needle valve with knurling in PVC grey</li> <li>• Float in PEEK nature</li> <li>• M10 sealing plug in PVC grey</li> <li>• Sample needle valve with knurling in PVC grey</li> <li>• Seal:                             <ul style="list-style-type: none"> <li>– O-ring (30 × 2.6) in FPM</li> <li>– O-ring (25 × 2.5) in Silicone</li> <li>– O-ring (12.42 × 1.78) in NBR</li> </ul> </li> </ul>
Dimensions	PMMA block: D 50 x W 80 x H 175 mm Further information can be found in chapter <b>"With one sensor slot for chlorine measurement"</b> on page 14.
Medium data	
Fluid flow rate	> 15 l/h (sample)
Fluid temperature	Max. 45 °C (max. 113 °F) Permitted operating temperature of the sensor has to be respected.
Fluid pressure	Max. 4 bar (58 PSI) Permitted operating pressure of the sensor has to be respected.

DTS 1000141421 EN Version: AB Status: RL (released | freigegeben | valide) printed: 20.05.2026

### With three sensor slots for chlorine, temperature and one other analysis measurements



This holder is designed for the installation of a chlorine sensor Type 8232, a temperature sensor (see chapter [“8.5. Ordering chart accessories” on page 26](#)) and one electrochemical electrode with a PG13.5 threaded connection (pH or ORP from Type 8203, conductivity from Type 8221). Further information can be found in the [data sheets Type 8232](#) ▶, [Type 8203](#) ▶ and [Type 8221](#) ▶.

Product properties	
Material	<ul style="list-style-type: none"> <li>• Body in PMMA polished</li> <li>• Variant cold water: connection in PP, screw connection in PVC</li> <li>• Variant warm water: connection in PVDF, screw connection in PVDF</li> </ul>
Dimensions	PMMA block: D 50 x W 140 x H 130 mm Further information can be found in chapter <a href="#">“With three sensor slots for chlorine, temperature and one other analysis measurements” on page 15</a> .
Medium data	
Fluid flow rate	> 30 l/h (sample)
Fluid temperature	<ul style="list-style-type: none"> <li>• Cold water variant: max. 50 °C (max. 122 °F)</li> <li>• Warm water variant: max. 80 °C (max. 176 °F)</li> </ul> Permitted operating temperature of the sensor has to be respected.
Fluid pressure	<ul style="list-style-type: none"> <li>• Cold water variant: max. 6 bar (87 PSI)</li> <li>• Warm water variant: max. 8 bar (116 PSI)</li> </ul> Permitted operating pressure of the sensor has to be respected.

### With four sensor slots for chlorine, temperature and two other analysis measurements



This holder is designed for the installation of a chlorine sensor Type 8232, a temperature sensor (see chapter [“8.5. Ordering chart accessories” on page 26](#)) and two electrochemical electrodes with a PG13.5 threaded connection (pH or ORP from Type 8203, conductivity from Type 8221). Further information can be found in the [data sheets Type 8232](#) ▶, [Type 8203](#) ▶ and [Type 8221](#) ▶.

Product properties	
Material	<ul style="list-style-type: none"> <li>• Body in PMMA polished</li> <li>• Connection in PVDF, screw connection in PVDF</li> </ul>
Dimensions	PMMA block: D 60 x W 140 x H 135 mm Further information can be found in chapter <a href="#">“With four sensor slots for chlorine, temperature and two other analysis measurements” on page 8</a> .
Medium data	
Fluid flow rate	> 30 l/h (sample)
Fluid temperature	Max. 80 °C (max. 176 °F) Permitted operating temperature of the sensor has to be respected.
Fluid pressure	Max. 8 bar (116 PSI) Permitted operating pressure of the sensor has to be respected.

## 3. Approvals and conformities

### 3.1. General notes

- The approvals and conformities listed below must be stated when making enquiries. This is the only way to ensure that the product complies with all required specifications.
- Not all available variants of the device can be supplied with the below mentioned approvals or conformities.

### 3.2. Conformity

In accordance with the Declaration of Conformity, the product is compliant with the EU Directives.

### 3.3. Standards

The applied standards which are used to demonstrate compliance with the EU Directives are listed in the EU-Type Examination Certificate and/or the EU Declaration of Conformity.

### 3.4. Pressure Equipment Directive (PED)

The device conforms to Article 4, Paragraph 1 of the Pressure Equipment Directive 2014/68/EU under the following conditions:

#### Device used on a pipe

##### Note:

- The data in the table is independent of the chemical compatibility of the material and the fluid.
- PS = maximum admissible pressure, DN = nominal diameter of the pipe

Type of fluid	Conditions
Fluid group 1, Article 4, Paragraph 1.c.i	DN ≤ 25
Fluid group 2, Article 4, Paragraph 1.c.i	DN ≤ 32 or PS*DN ≤ 1000
Fluid group 1, Article 4, Paragraph 1.c.ii	DN ≤ 25 or PS*DN ≤ 2000
Fluid group 2, Article 4, Paragraph 1.c.ii	DN ≤ 200 or PS ≤ 10 or PS*DN ≤ 5000

#### Device used on a vessel

##### Note:

- The data in the table is independent of the chemical compatibility of the material and the fluid.
- PS = maximum admissible pressure, V = vessel volume

Type of fluid	Conditions
Fluid group 1, Article 4, Paragraph 1.a.i	V > 1 L and PS*V ≤ 25 bar.L or PS ≤ 200 bar
Fluid group 2, Article 4, Paragraph 1.a.i	V > 1 L and PS*V ≤ 50 bar.L or PS ≤ 1000 bar
Fluid group 1, Article 4, Paragraph 1.a.ii	V > 1 L and PS*V ≤ 200 bar.L or PS ≤ 500 bar
Fluid group 2, Article 4, Paragraph 1.a.ii	PS > 10 bar and PS*V ≤ 10000 bar.L or PS ≤ 1000 bar

### 3.5. Foods and beverages/Hygiene

Conformity	Description
FDA	<b>FDA – Code of Federal Regulations</b> The variants with the housing made of stainless steel (316L/1.4435) materials and the seal made of EPDM materials comply in their composition with the Code of Federal Regulations published by the FDA (Food and Drug Administration, USA) according to the manufacturer's declaration.
USP	<b>United States Pharmacopeial Convention (USP)</b> The variants with the housing made of stainless steel (316L/1.4435) materials and the seal made of EPDM materials are biocompatible according to USP or ISO according to the manufacturer's declaration.
	<b>EC Regulation 1935/2004 of the European Parliament and of the Council</b> All wetted materials are compliant with EC Regulation 1935/2004 according to the manufacturer's declaration.

## 4. Materials

### 4.1. Bürkert resistApp

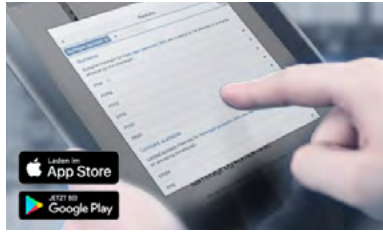

#### Bürkert resistApp – Chemical resistance chart

You want to ensure the reliability and durability of the materials in your individual application case? Verify your combination of media and materials on our website or in our resistApp.

[Start chemical resistance check](#)

## 5. Dimensions

### 5.1. General purpose holder

#### G 2" connection

**Note:**

- Dimensions in mm, unless otherwise stated
- With analysis probe and Pt1000 temperature probe/liquid earthing pin (must be ordered separately)
- For installation on Bürkert Type S020 fitting made of PVC or stainless steel

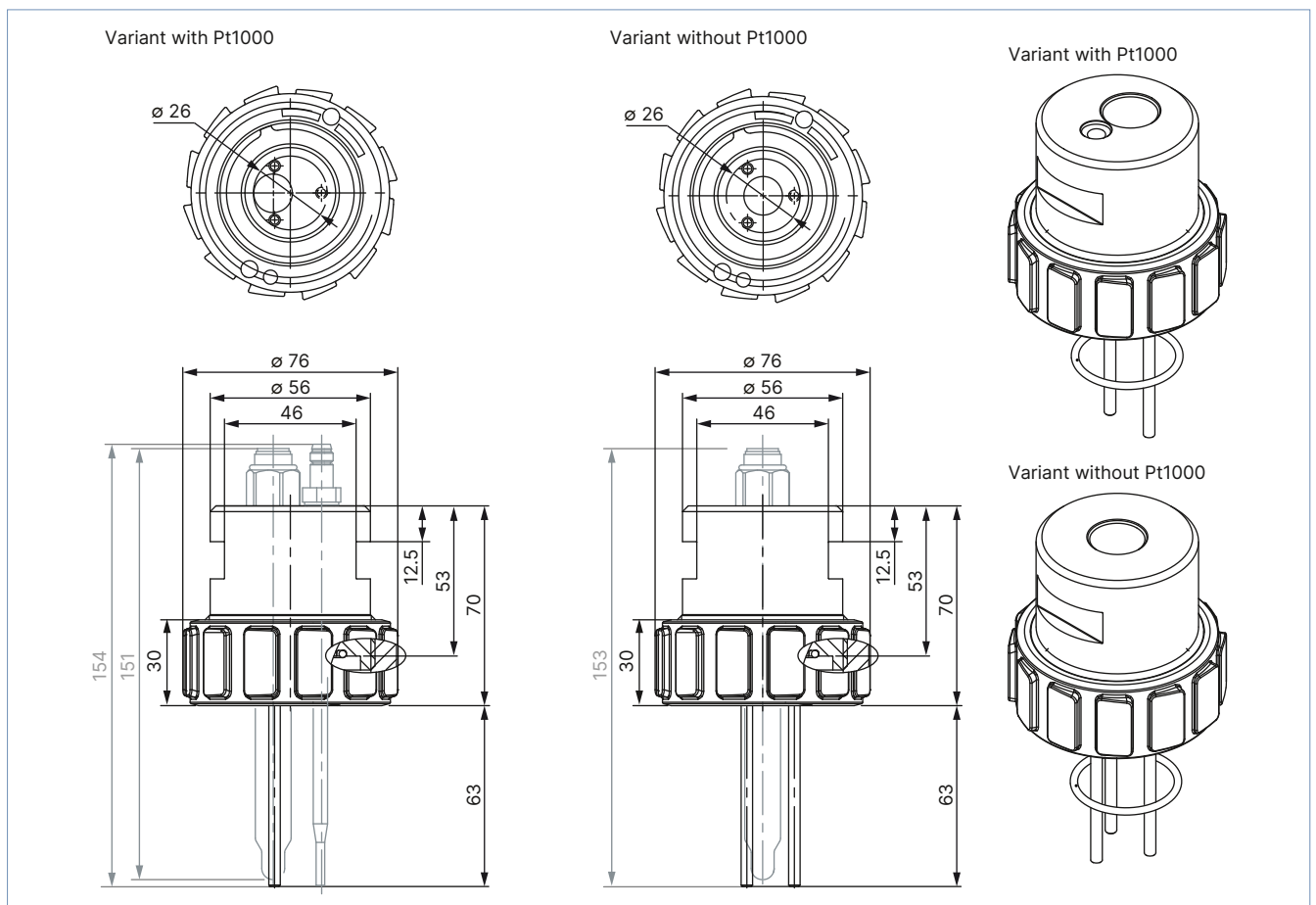

**G 1" connection**

**Note:**

- Dimensions in mm, unless otherwise stated
- With analysis probe and Pt1000 temperature probe/liquid earthing pin (must be ordered separately)
- For installation on T-fitting made of PVC

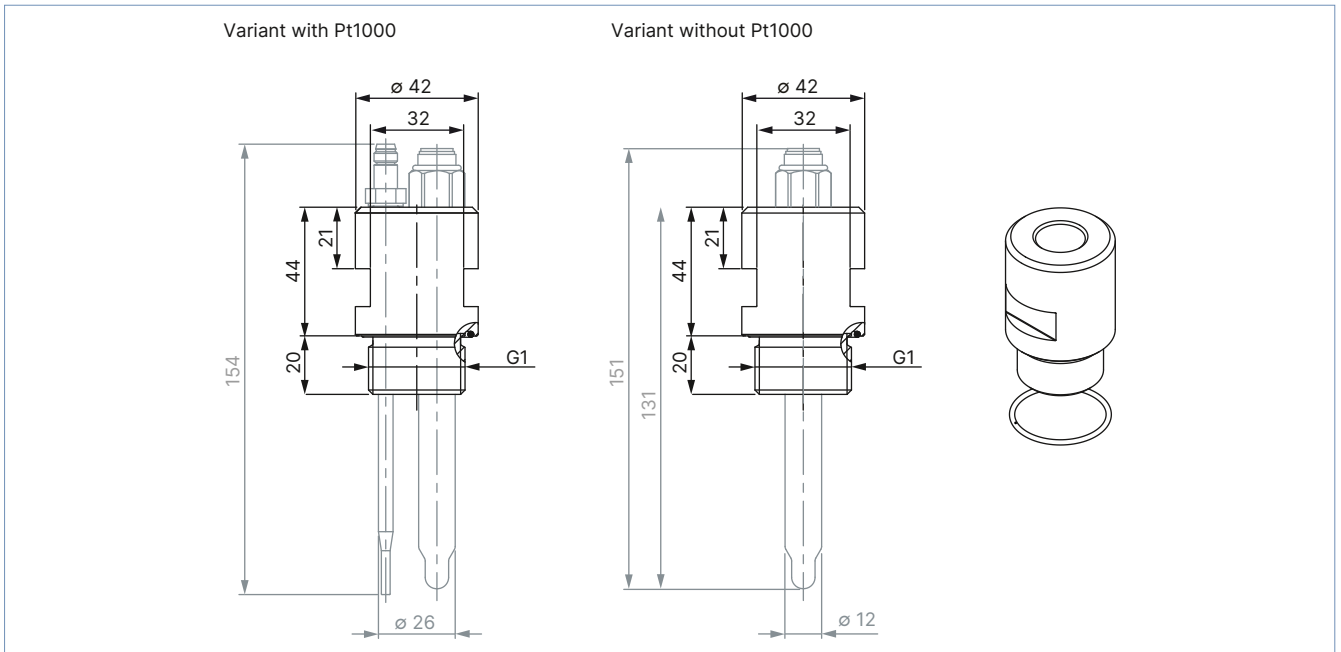

**Solvent union connection**

**Note:**

- Dimensions in mm, unless otherwise stated
- With analysis probe and Pt1000 temperature probe/liquid earthing pin (must be ordered separately)
- For installation on T-fitting made of PVC

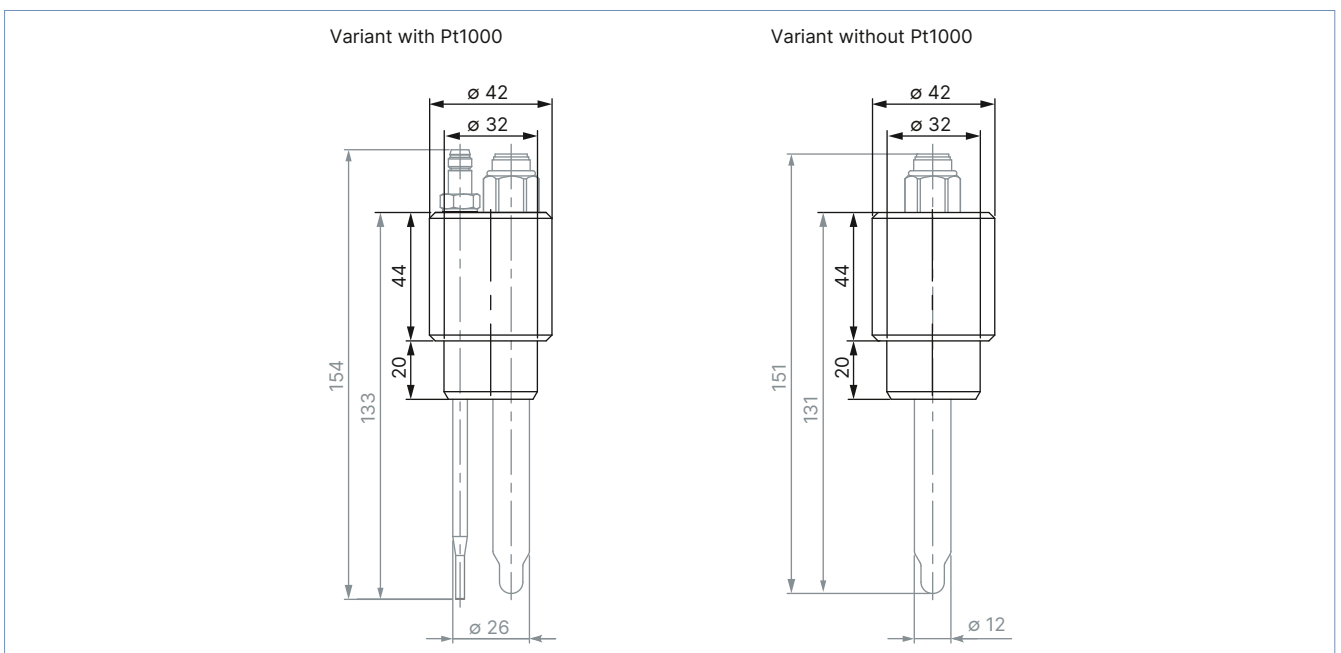

DTS 1000141421 EN Version: AB Status: RL (released | freigegeben | valide) printed: 20.05.2026

### 5.2. Hygienic holder

#### G 1¼" connection (28 or 46 mm O-ring position)

**Note:**

- Dimensions in mm, unless otherwise stated
- With analysis probe (must be ordered separately)
- To install in weld-in socket 15°, see chapter "8.5. Ordering chart accessories" on page 26 and data sheet Type BBS-11 ▶

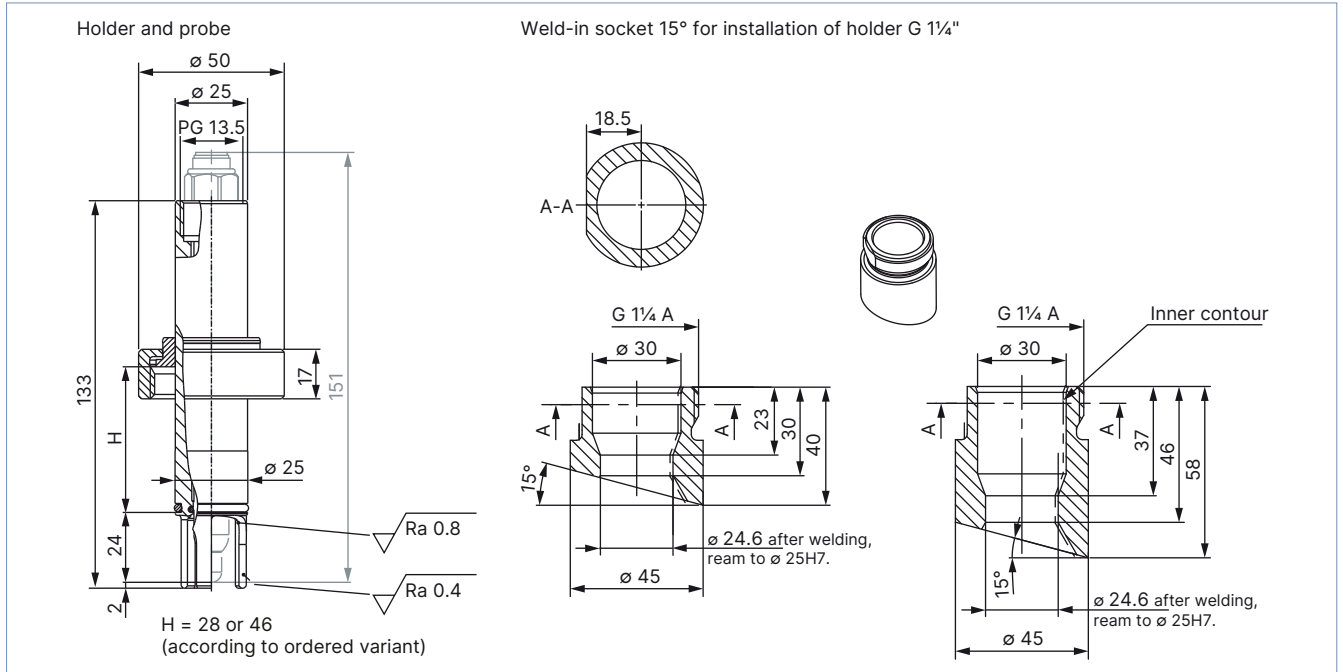

#### 1½" clamp connection (Ø 50.5 mm), short immersion depth

**Note:**

- Dimensions in mm, unless otherwise stated
- With analysis probe (must be ordered separately)

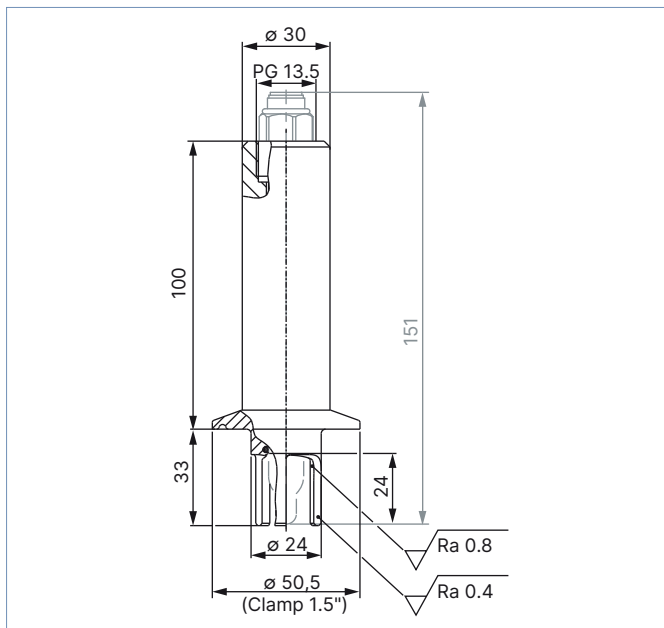

DTS 1000141421 EN Version: AB Status: RL (released | freigegeben | valide) printed: 20.05.2026

**1½" clamp connection (Ø 50.5 mm), long immersion depth**

**Note:**

- Dimensions in mm, unless otherwise stated
- With analysis probe and Pt1000 temperature probe/liquid earthing pin (must be ordered separately)

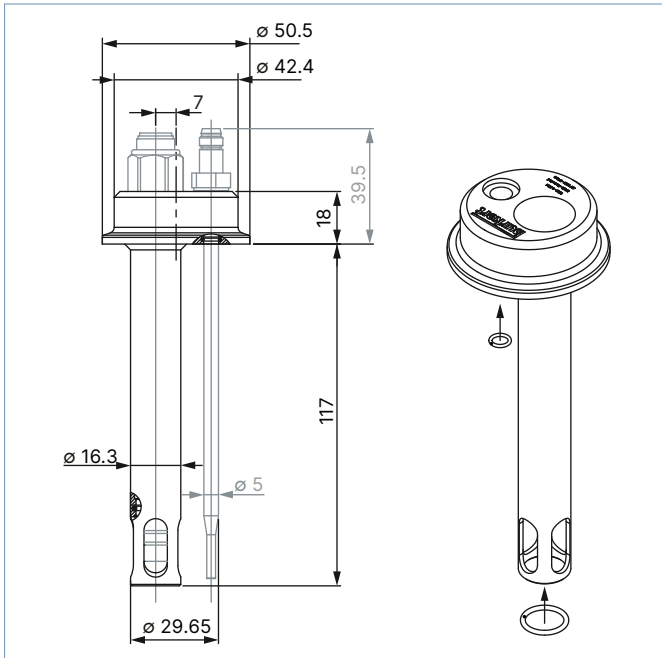

**2" (DN 50/40) connection adapted for GEA Tuchenhagen VARINLINE process connections**

**Note:**

- Dimensions in mm, unless otherwise stated
- With analysis probe (must be ordered separately)

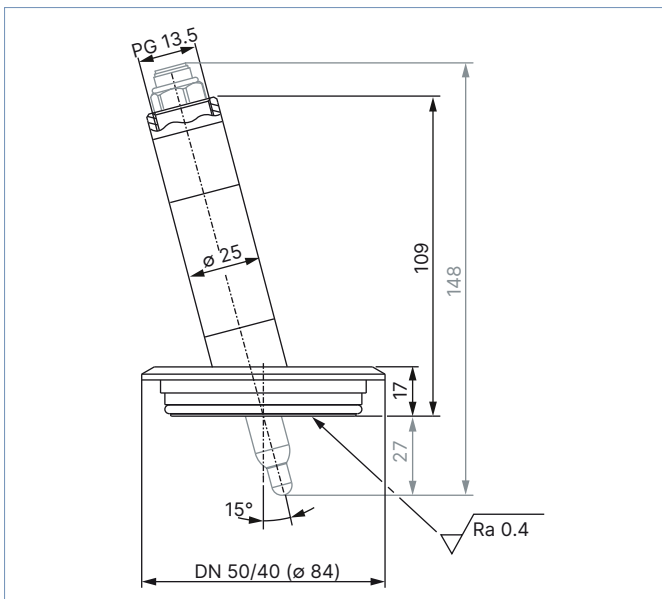

### 5.3. Analysis measurement chamber

#### With one sensor slot for chlorine measurement

**Note:**

Dimensions in mm, unless otherwise stated

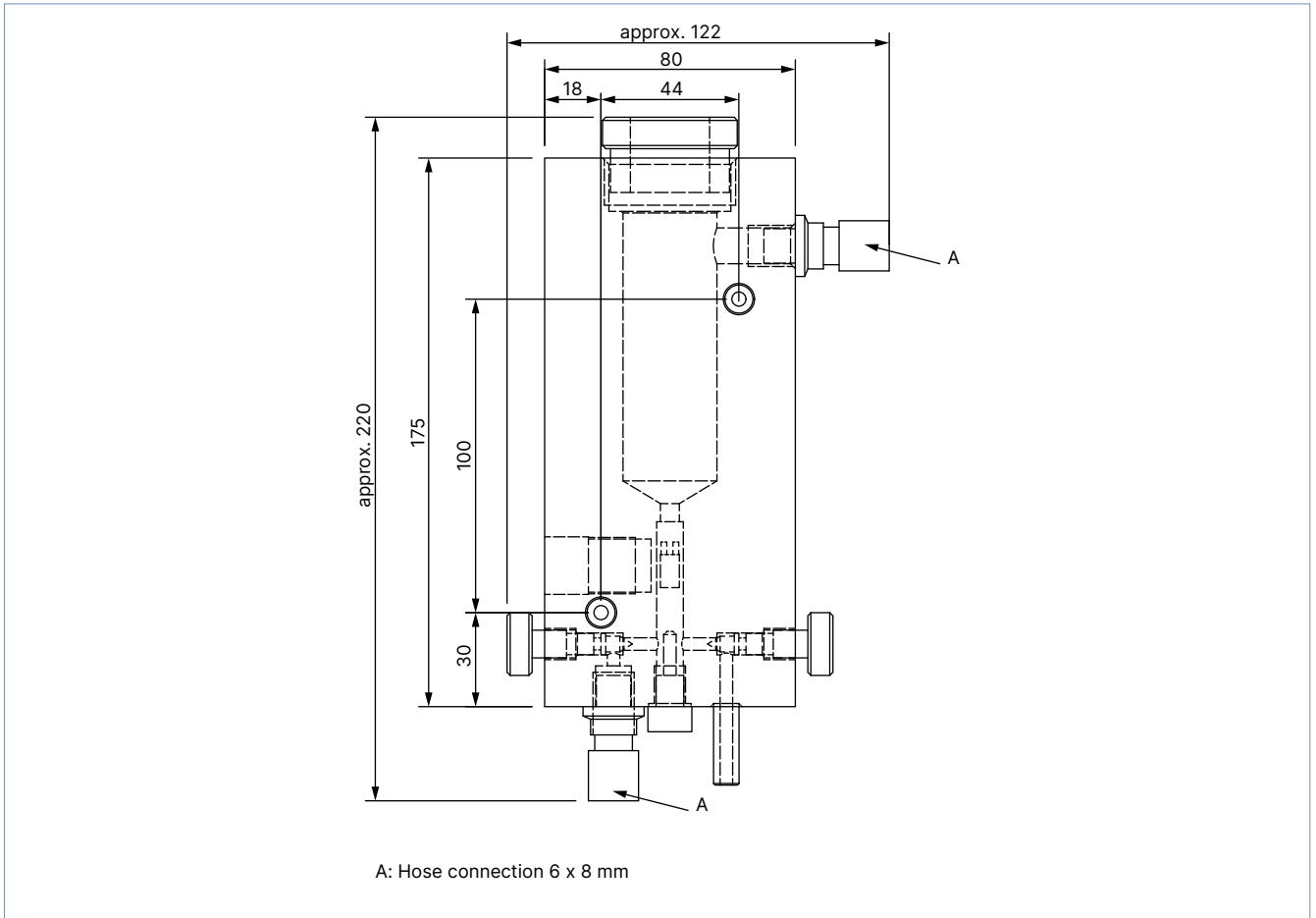

With three sensor slots for chlorine, temperature and one other analysis measurements

**Note:**

Dimensions in mm, unless otherwise stated

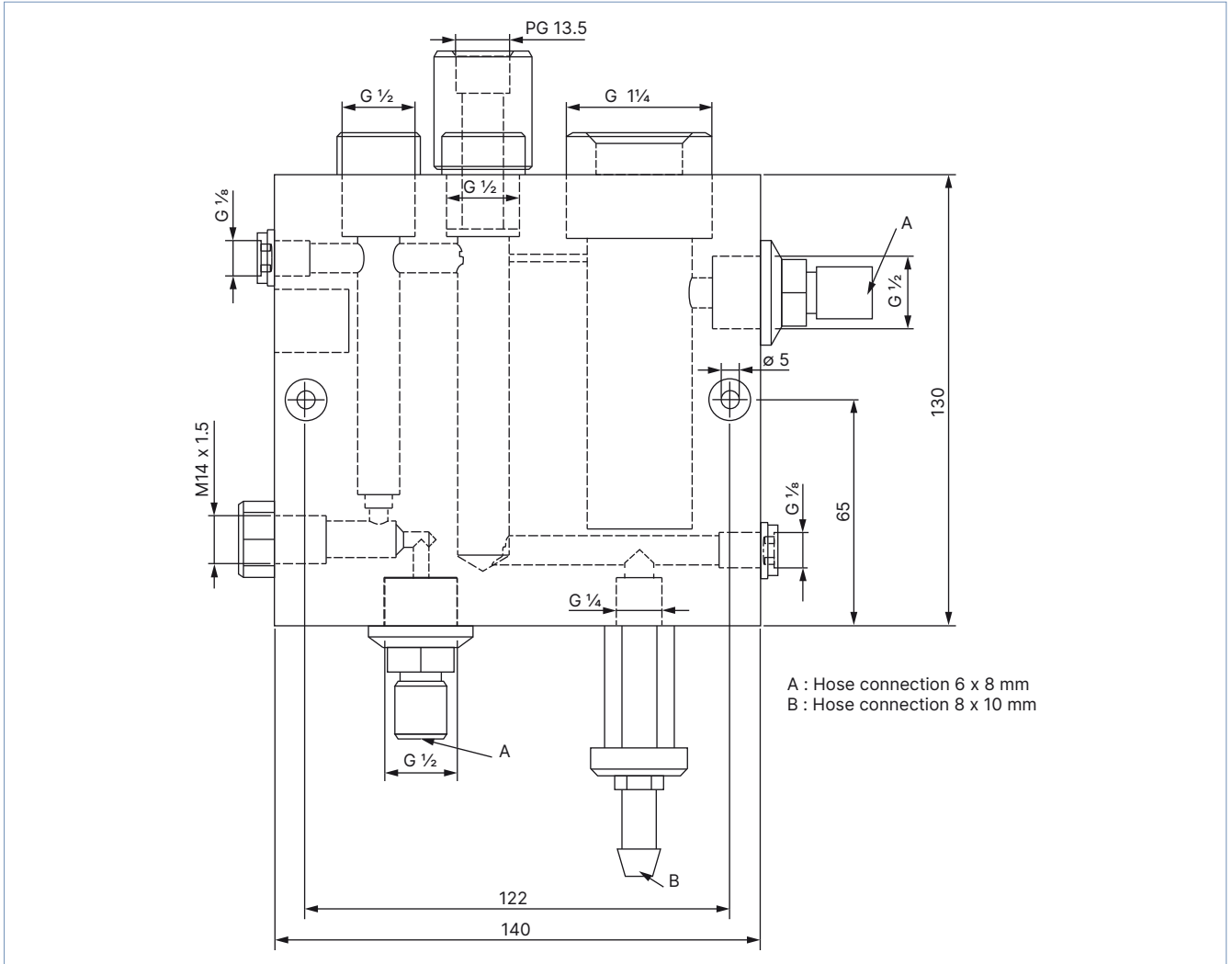

DTS 1000141421 EN Version: AB Status: RL (released | freigegeben | valide) printed: 20.05.2026

**With four sensor slots for chlorine, temperature and two other analysis measurements**

**Note:**

Dimensions in mm, unless otherwise stated

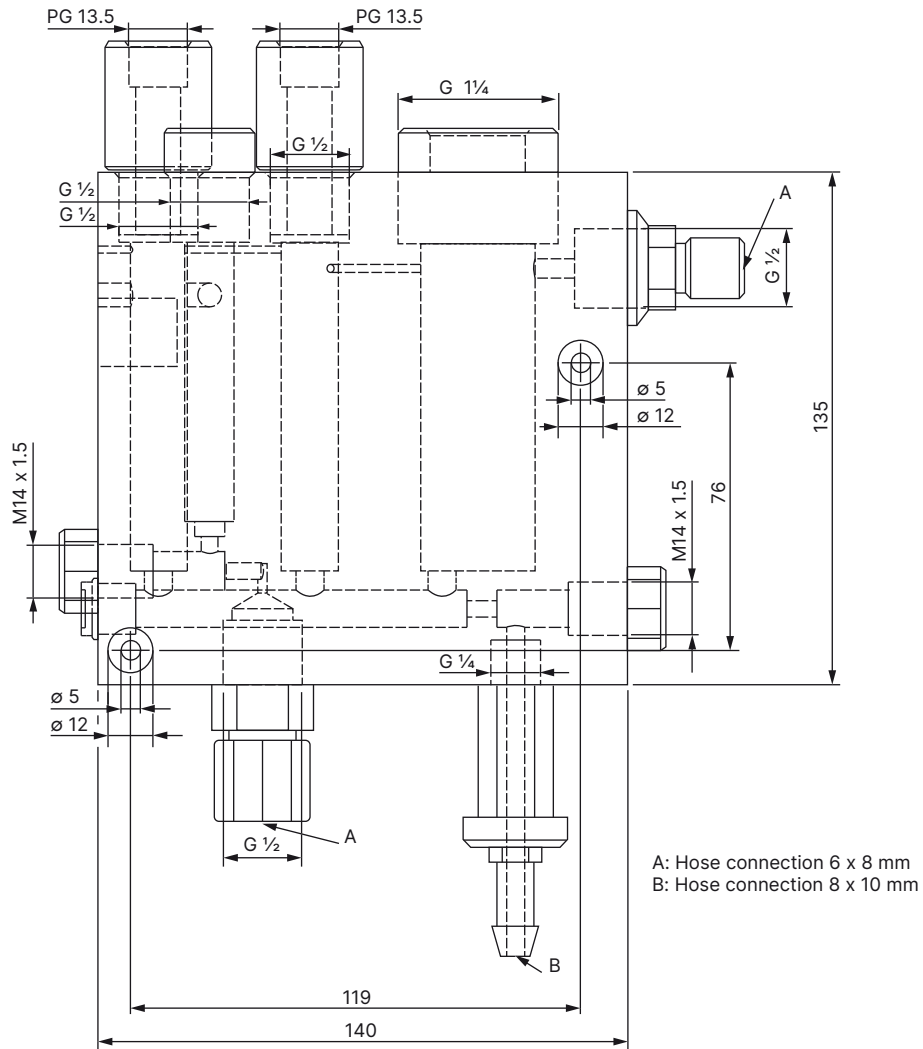

DTS 1000141421 EN Version: AB Status: RL (released | freigegeben | valide) printed: 20.05.2026

## 6. Product installation

### 6.1. Installation notes

#### General purpose holder with G 2" connection for installation on Type S020 Bürkert fitting

A complete pH/ORP/conductivity sensor consists of the following components:

Installation example	No.	Description
	1	A complete probe holder Type 8200 with nut and seals
	2	A pH/ORP probe Type 8203 or a conductivity probe Type 8221 of 120 mm with PG13.5 connection See <a href="#">data sheet Type 8203</a> ▶ or <a href="#">data sheet Type 8221</a> ▶
	3	A Pt1000 temperature probe/liquid earthing pin (optional, if needed) Further information can be found in chapter <a href="#">"8.5. Ordering chart accessories"</a> on page 26.
	4	An Type S020 Bürkert fitting (G 2" connection) See <a href="#">data sheet Type S020</a> ▶

#### General purpose holder with G 1" or solvent connection for installation on T-fitting

A complete pH/ORP/conductivity sensor consists of the following components:

Installation example	No.	Description
	1	A probe holder Type 8200 with external thread G 1" process connection or solvent union process connection
	2	A pH/ORP probe Type 8203 or conductivity probe Type 8221 of 120 mm with PG13.5 connection See <a href="#">data sheet Type 8203</a> ▶ or <a href="#">data sheet Type 8221</a> ▶
	3	A Pt1000 temperature probe/liquid earthing pin (optional, if needed) Further information can be found in chapter <a href="#">"8.5. Ordering chart accessories"</a> on page 26.
	4	A T-fitting (with internal thread G 1" connection or solvent union Ø 32 mm connection to the probe holder)

#### Hygienic holder with G 1¼" connection and O-ring position of 28 or 46 mm for installation on sockets

A complete pH/ORP/conductivity sensor consists of the following components:

Installation example	No.	Description
	1	A G 1¼" probes holder Type 8200 with O-ring position of 28 mm or 46 mm
	2	A pH/ORP probe Type 8203 or conductivity probe Type 8221 of 120 mm with PG13.5 connection See <a href="#">data sheet Type 8203</a> ▶ or <a href="#">data sheet Type 8221</a> ▶
	3	A Type BBS- 11 weld-in socket with 15° (sockets 15°) which are welded on pipes or tanks The sockets have a safety construction. The socket seals only if the O-ring of the holder is exactly in the right position. Otherwise the fluid leaks through the G 1¼" coupling nut. Further information on socket ordering can be found in chapter <a href="#">"8.5. Ordering chart accessories"</a> on page 26 or see <a href="#">data sheet Type BBS-11</a> ▶.

DTS 1000141421 EN Version: AB Status: RL (released | freigegeben | valide) printed: 20.05.2026

**Analysis measurement chamber**

**With one sensor slot for chlorine measurement**

**Note:**

- The special holder is intended for use with a Type 8232 chlorine sensor, see **data sheet Type 8232** ▶ for further information.
- Observe the maximum height of the chlorine sensor (approx. 220 mm without connected cable) when selecting the installation site for the Type 8200 analysis measurement chamber, so that the sensor can be set into the analysis measurement chamber.

A complete chlorine sensor consists of the following components:

Installation example	No.	Description
	<p><b>1</b></p> <p>A chlorine sensor Type 8232 (not included in the delivery), see <b>data sheet Type 8232</b> ▶</p> <ol style="list-style-type: none"> <li>1. Seal</li> <li>2. Slide ring</li> <li>3. Snap ring</li> </ol>	
	<p><b>2</b></p> <p>An analysis measurement chamber Type 8200 with nut and seals, which is made of:</p> <ol style="list-style-type: none"> <li>1. Water outlet, 6 × 8 mm hose connection</li> <li>2. Float (flow indicator)</li> <li>3. Knurling for sample</li> <li>4. Water sample</li> <li>5. M10 sealing plug</li> <li>6. Water inlet, 6 × 8 mm hose connection</li> <li>7. Knurling for flow regulation</li> <li>8. Drilling for flow switch (optional)</li> <li>9. Holes for fixing screws</li> <li>10. Union nut for holding the sensor (to be removed before installing the chlorine sensor, seal and rings, then screwed back in to tighten the sensor)</li> </ol>	

DTS 1000141421 EN Version: AB Status: RL (released | freigegeben | valide) printed: 20.05.2026

**With three slots for chlorine, temperature sensors and one other analysis probes**

**Note:**

- The special holder is intended for use with a Type 8232 chlorine sensor, a temperature sensor (see chapter “8.5. Ordering chart accessories” on page 26) and one other analysis probe (pH, ORP Type 8203 or conductivity Type 8221...) with a PG13.5 threaded connection, see **data sheets Type 8232 ▶, Type 8203 ▶ and Type 8221 ▶** for further information.
- Observe the maximum height of the chlorine sensor (approx. 220 mm without connected cable) when selecting the installation site for the Type 8200 analysis measurement chamber, so that the sensor can be set into the analysis measurement chamber.

A complete analysis system consists of the following components:

Installation example	No.	Description
	<p><b>1</b> A chlorine sensor Type 8232 (not included in the delivery), see <b>data sheet Type 8232 ▶</b></p> <ol style="list-style-type: none"> <li>1. Seal</li> <li>2. Slide ring</li> <li>3. Snap ring</li> </ol>	
	<p><b>2</b> An analysis measurement chamber Type 8200 with nut and seals, which is made of:</p> <ol style="list-style-type: none"> <li>1. Thread for sensor union nut (not shown)</li> <li>2. Water outlet, 6 × 8 mm hose connection</li> <li>3. Holes for fixing screws</li> <li>4. Sealing plug (drain)</li> <li>5. Sampling tap, 8 × 10 mm hose connection</li> <li>6. Water inlet, 6 × 8 mm hose connection</li> <li>7. Knurling for flow regulation</li> <li>8. Float (flow indicator)</li> <li>9. Drilling for flow switch (optional)</li> <li>10. Sealing plug (drain)</li> <li>11. For temperature sensor (not included in the delivery, see chapter “8.5. Ordering chart accessories” on page 26) or sealing plug</li> <li>12. Union nut</li> </ol>	
	<p><b>3</b> An analysis probe with a PG13.5 threaded connection (not included in the delivery) or if none a sealing plug</p>	

DTS 1000141421 EN Version: AB Status: RL (released | freigegeben | valide) printed: 20.05.2026

**With four slots for chlorine, temperature sensors and two other analysis probes**

**Note:**

- The special holder is intended for use with a Type 8232 chlorine sensor, a temperature sensor (see chapter “8.5. Ordering chart accessories” on page 26) and two other analysis probes (pH, ORP Type 8203 or conductivity Type 8221...) with a PG13.5 threaded connection, see **data sheets Type 8232 ▶, Type 8203 ▶ and Type 8221 ▶** for further information.
- Observe the maximum height of the chlorine sensor (approx. 220 mm without connected cable) when selecting the installation site for the Type 8200 analysis measurement chamber, so that the sensor can be set into the analysis measurement chamber.

A complete analysis system consists of the following components:

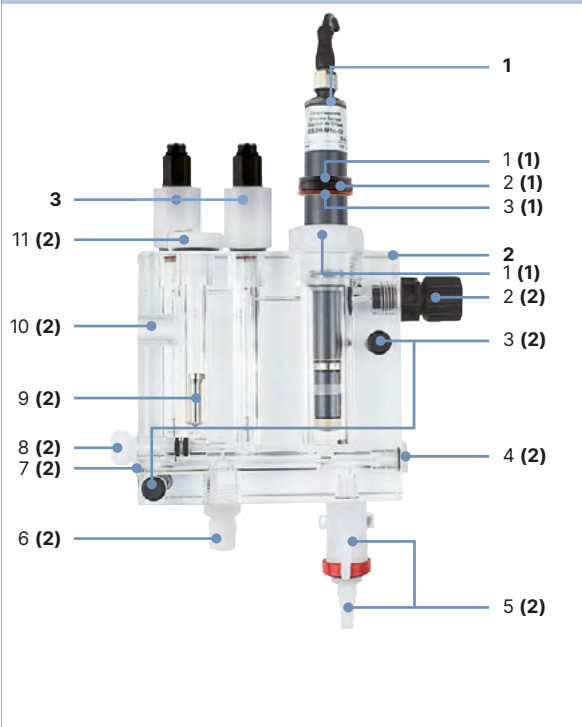
Installation example	No.	Description
	<p><b>1</b></p> <p>A chlorine sensor Type 8232 (not included in the delivery), see <b>data sheet Type 8232 ▶</b></p> <ol style="list-style-type: none"> <li>1. Seal</li> <li>2. Slide ring</li> <li>3. Snap ring</li> </ol>	
	<p><b>2</b></p> <p>An analysis measurement chamber Type 8200 with nut and seals, which is made of:</p> <ol style="list-style-type: none"> <li>1. Union nut for holding the sensor (to be removed before installing the chlorine sensor, seal and rings, then screwed back in to tighten the sensor)</li> <li>2. Water outlet, 6 × 8 mm hose connection</li> <li>3. Holes for fixing screws</li> <li>4. Sealing plug (drain)</li> <li>5. Sampling tap, 8 × 10 mm hose connection</li> <li>6. Water inlet, 6 × 8 mm hose connection</li> <li>7. Sealing plug (drain)</li> <li>8. Knurling for flow regulation</li> <li>9. Float (flow indicator)</li> <li>10. Drilling for flow switch (optional)</li> <li>11. For temperature sensor (not included in the delivery, see chapter “8.5. Ordering chart accessories” on page 26) or sealing plug</li> </ol>	
	<p><b>3</b></p> <p>Analysis probes with a PG13.5 threaded connection (not included in the delivery) or if none a sealing plug</p>	

DTS 1000141421 EN Version: AB Status: RL (released | freigegeben | valide) printed: 20.05.2026

## 7. Networking and combination with other Bürkert products

### 7.1. Combination of general purpose holder with G 2" connection for installation on S020 Bürkert fitting

Example:

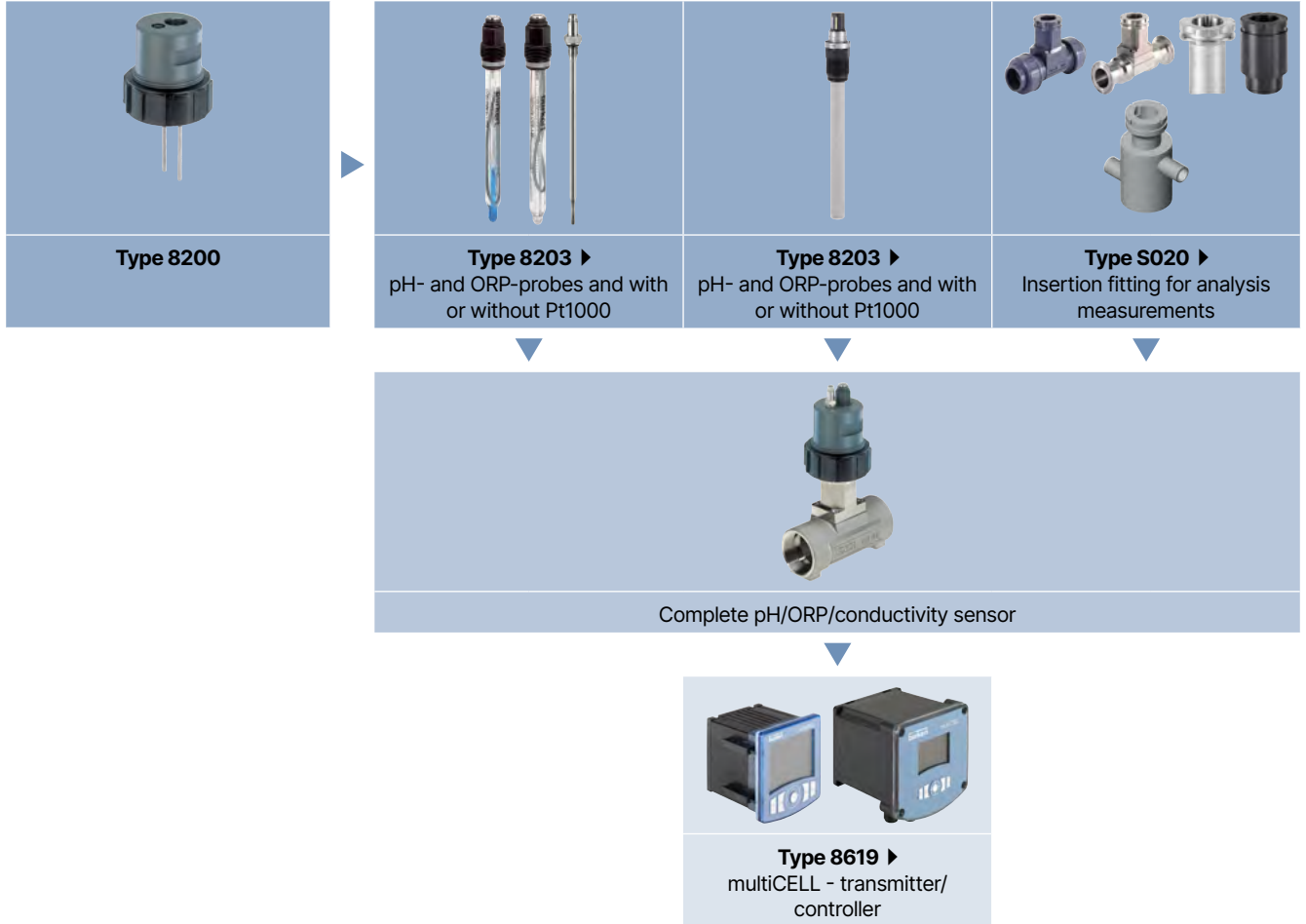

### 7.2. Combination with available Type S020 Insertion fittings DN

Available S020 fittings DN	DN15	DN32 <sup>1)</sup>	DN50	DN65	DN100	DN200	
T-Fitting	Available						
Welding socket			Available				
Fusion spigot				Available			
Analytical measurement using probe holder G 2" connection for S020	Available <sup>2)</sup>						

1.) Except fittings with external threads acc. to SMS 1145, weld ends acc. to SMS 3008, BS 4825-1/ASME BPE/DIN 11866 series C or DIN 11850 series 2/DIN 11866 series A/ DIN EN 10357 series A, Clamp acc. to SMS 3017, BS 4825-3/ASME BPE, DIN 32676 series A  
 2.) Only use plastic fittings with true union process connection in the analysis variant, with nut and solvent/fusion socket according to DIN 8063 (PVC), to DIN 16962 (PP) or to ISO 10931 (PVDF), other materials are available on request.

See **data sheet Type S020** ▶ for more information.

### 7.3. Combination of general purpose with G 1", solvent connection or hygienic holders

Example:

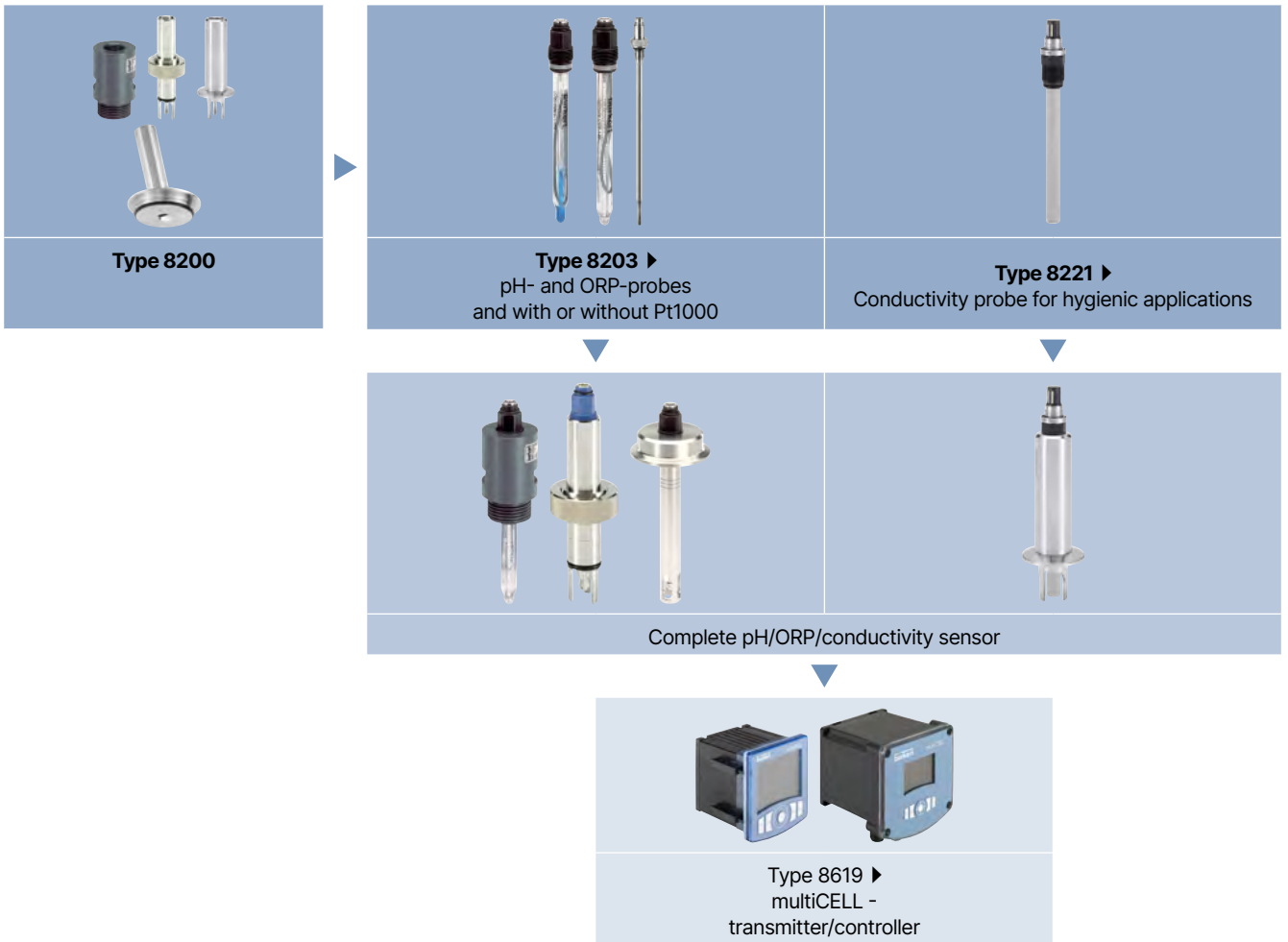

DTS 1000141421 EN Version: AB Status: RL (released | freigegeben | valide) printed: 20.05.2026

### 7.4. Combination of the analysis measurement chamber

Example:

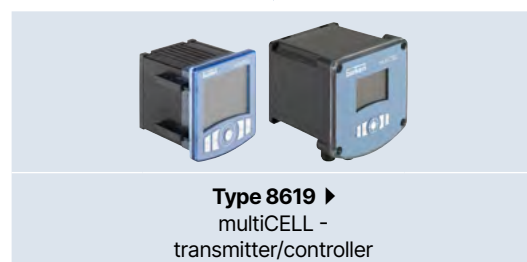
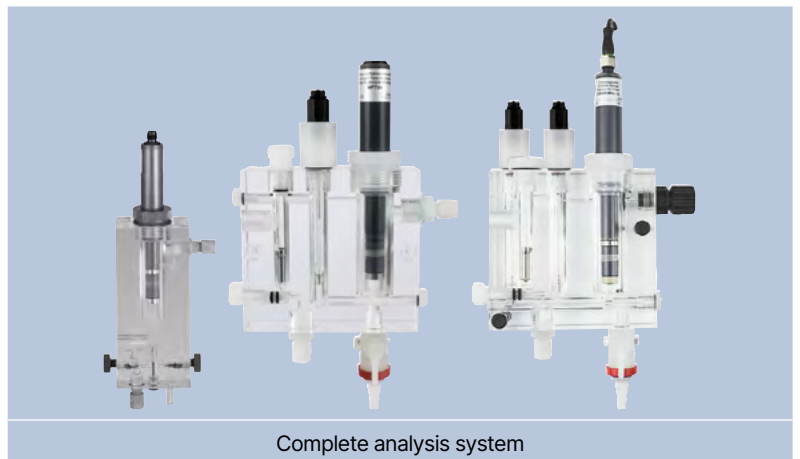
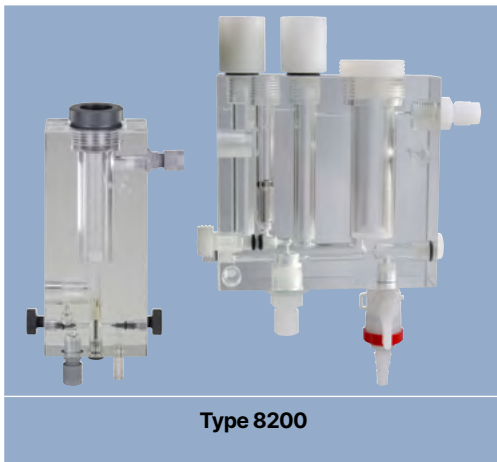

DTS 1000141421 EN Version: AB Status: RL (released | freigegeben | valide) printed: 20.05.2026

## 8. Ordering information

### 8.1. Bürkert eShop



#### Bürkert eShop – Easy ordering and quick delivery

You want to find your desired Bürkert product or spare part quickly and order directly? Our online shop is available for you 24/7. Sign up and enjoy all the benefits.

[Order online now](#)

### 8.2. Recommendation regarding product selection

#### General purpose or hygienic holders for pH/ORP/conductivity measurement for tank or pipe installation

Depending on the type of measurement to be performed, different components must be ordered to obtain a complete pH, ORP or conductivity measurement device for tank or pipe installation. The following information is required:

- For pH/ORP measurement
  - **Article no.** of the probe holder **Type 8200**
  - **Article no.** of the pH or ORP probe **Type 8203** (see **data sheet Type 8203** ▶)
  - **Article no.** of the Pt1000 temperature probe/liquid earthing pin if needed (see chapter **“8.5. Ordering chart accessories” on page 26**)
  - **Article no.**
    - of the selected Insertion fitting **Type S020** (DN 15...DN 200, see **data sheet Type S020** ▶) **only** if probe holder has a G 2" connection or
    - of the selected socket (see chapter **“8.5. Ordering chart accessories” on page 26**) **only** if the probes holder has a G 1¼" connection with O-ring position of 28 or 46 mm.
- For conductivity measurement
  - **Article no.** of the probe holder **Type 8200**
  - **Article no.** of the conductivity probe **Type 8221** (see **data sheet Type 8221** ▶)
  - **Article no.**
    - of the selected Insertion fitting **Type S020** (DN 15...DN 200, see **data sheet Type S020** ▶) **only** if probe holder has a G 2" connection or
    - of the selected socket (see chapter **“8.5. Ordering chart accessories” on page 26**) **only** if the probes holder has a G 1¼" connection with O-ring position of 28 or 46 mm.

#### Analysis measurement chamber

##### Note:

- A complete analysis measurement system consists of a analysis measurement chamber Type 8200, a chlorine sensor and, depending on the analysis measurement chamber variant, a temperature sensor and one or two analysis probes.
- If a slot is not used, it must be sealed with a sealing plug (see chapter **“8.5. Ordering chart accessories” on page 26**).

Different components must be ordered to obtain a complete device. The following information is required:

- **Article no.** of the analysis measurement chamber **Type 8200**
- **Article no.** of the chlorine sensor **Type 8232** (see **data sheet Type 8232** ▶)
- **Article no.** of the temperature sensor (see chapter **“8.5. Ordering chart accessories” on page 26**)
- **Article no.** of the pH or ORP probes Type 8203 (see **data sheet Type 8203** ▶) or of the conductivity probe Type 8221 (see **data sheet Type 8221** ▶) if needed
- **Article no.** of the flow switch for continuous monitoring of the flow according to the analysis measurement chamber variant (optional, see chapter **“8.5. Ordering chart accessories” on page 26**)

### 8.3. Bürkert product filter













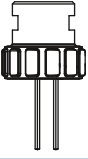





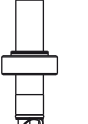

**Bürkert product filter – Get quickly to the right product**

You want to select products comfortably based on your technical requirements? Use the Bürkert product filter and find suitable articles for your application quickly and easily.

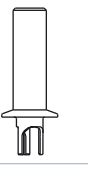
[Try out our product filter](#)





### 8.4. Ordering chart

General purpose or hygienic holders for pH/ORP/conductivity measurement for tank or pipe installation







Process connection	Variant	Material	Boring for Pt1000 temperature probe/ liquid earthing pin	Protection rods/tube	Article no.	
<b>General purpose holder</b>						
	G 2" connection for installation on Bürkert Insertion fitting S020	Standard	PVC	No	Yes	429224 
				Yes	Yes	429228 
			Stainless steel 316L/1.4404	No	Yes	429227 
				Yes	Yes	429231 
	G 1" connection	Short	PVC	No	No	429220 
				Yes	No	429221 
	Stick connection	Short	PVC	No	No	564236 
				Yes	No	563475 
<b>Hygienic purpose holder</b>						
	G 1 1/4" connection	High = 28	Stainless steel 316L/1.4435	No	Yes	562431 
		High = 46	Stainless steel 316L/1.4435	No	Yes	562432 
	1 1/2" clamp connection (Ø 50.5 mm)	Short immersion depth	Stainless steel 316L/1.4435	No	Yes	558885 
	1 1/2" clamp connection (Ø 50.5 mm)	Long immersion depth	Stainless steel 316L/1.4404	Yes	Yes	429235 
	2" (DN 50/40) connection adapted for GEA Tuchenha-gen VARINLINE process connections	15°	Stainless steel 316L/1.4435	No	Yes	562433 

DTS 1000141421 EN Version: AB Status: RL (released | freigegeben | valide) printed: 20.05.2026

### Analysis measurement chamber

Description	Article no.
Analysis measurement chamber with 1 slot (G 1¼" connection) for a chlorine sensor	569221 
Analysis measurement chamber with 1 slot (G 1¼" connection) for a chlorine sensor, 1 slot (G ½" connection) for a temperature sensor and 1 slot (PG13.5) for an analysis probe, cold water variant	571930 
Analysis measurement chamber with 1 slot (G 1¼" connection) for a chlorine sensor, 1 slot (G ½" connection) for a temperature sensor and 1 slot (PG13.5) for an analysis probe, warm water variant	571931 
Analysis measurement chamber with 1 slot (G 1¼" connection) for a chlorine sensor, 1 slot (G ½" connection) for a temperature sensor and 2 slots (PG13.5) for two analysis probes	571932 

### 8.5. Ordering chart accessories

Description	Article no.
<b>Temperature probe for general purpose holders G 2", G 1", stick connection and hygienic holders 1½" clamp or DN 50 thread process connection</b>	
Pt1000/earthing pin made of stainless steel 1.4571	427023 
Pt1000/earthing pin made of titanium	560317 
<b>For general purpose holders G 2" connection</b>	
Set with FKM seals	429264 
Set with a green FKM seal and a black EPDM seal	552111 
<b>For hygienic holder G 1¼" connection</b>	
Weld-in socket 15° <b>Type BBS- 11</b> ▶, length: 30 mm for holder G 1¼"	747772 
Weld-in socket 15° <b>Type BBS- 11</b> ▶, length: 46 mm for holder G 1¼"	737260 
<b>For analysis measurement chamber</b>	
Pt100 temperature sensor with 4 m cable for analysis measurement chambers with 3 or 4 sensor slots	571962 
Flow switch for analysis measurement chamber, PNP, 2 m cable (optional)	775261 