



## Ultrasonic level measuring device

- For level measurement up to 8 m
- 4...20 mA/HART - 2 wires
- Suitable for solids
- ATEX certification



Product variants described in the data sheet may differ from the product presentation and description.

### Can be combined with

	<b>Type 8611</b> eCONTROL - Universal controller	▶
	<b>Type 8644</b> Remote Process Actuation Control System AirLINE	▶
	<b>Type 8793</b> Digital electropneumatic Process Controller SideControl	▶
	<b>Type 8802</b> ELEMENT continuous control valve systems - overview	▶

### Type description

The type 8177 is a non-contact ultrasonic level measuring device, designed for continuous level measurement in open or closed vessels.

The unit is suitable for liquids, but also for solids, in virtually all industries, particularly in water and waste water management.

## Table of contents

<b>1. General technical data</b>	<b>3</b>
<b>2. Approvals</b>	<b>5</b>
2.1. ATEX-Certification.....	5
<b>3. Materials</b>	<b>5</b>
3.1. Chemical Resistance Chart – Bürkert resistApp.....	5
<b>4. Dimensions</b>	<b>6</b>
<b>5. Performance specifications</b>	<b>7</b>
5.1. Measurement deviation diagram .....	7
<b>6. Product operation</b>	<b>7</b>
6.1. Measuring principle .....	7
6.2. Product operation notes .....	7
Set up with display/configuration module .....	7
<b>7. Ordering information</b>	<b>8</b>
7.1. Bürkert eShop – Easy ordering and quick delivery.....	8
7.2. Bürkert product filter.....	8
7.3. Ordering chart.....	8
7.4. Ordering chart accessories.....	8

## 1. General technical data

### Product properties

#### Material

Please make sure the device materials are compatible with the fluid you are using. Detailed information can be found in chapter [“3.1. Chemical Resistance Chart – Bürkert resistApp”](#) on page 5.

#### Non wetted parts

Housing	PBT, stainless steel 316L (1.4404)
Cover	PC transparent
Seal between housing and cover	EPDM
Cable gland	PA
Blind plug	PA
Ground terminal	Stainless steel 316Ti/316L (1.4571/1.4435)

#### Wetted parts

Process connection	PVDF
Transducer	PVDF
Process seal	EPDM

Dimensions	Detailed information can be found in chapter <a href="#">“4. Dimensions”</a> on page 6.
Weights	1.8...4 kg (depending on process connection and housing)
Measuring variable	Distance between lower edge of the transducer and product surface. Detailed information can be found in chapters <a href="#">“5.1. Measurement deviation diagram”</a> on page 7.
Measuring range	<ul style="list-style-type: none"> <li>• 0.4...8 m (for liquids)</li> <li>• 0.4...3.5 m (for solids)</li> </ul>
Beam angle <sup>1)</sup>	11°
Damping (63 % of the input value)	0...999 s, adjustable
Adjustment time <sup>2)</sup>	>3 s (dependent on the parameter adjustment)

#### Product accessories

Display	LCD in full dot matrix. Detailed information can be found in chapter <a href="#">“7.4. Ordering chart accessories”</a> on page 8.
---------	-----------------------------------------------------------------------------------------------------------------------------------

### Performance data

Blocking distance	0.4 m
Measurement deviation	±4 mm (measuring distance >0.2 m) Detailed information can be found in chapter <a href="#">“5.1. Measurement deviation diagram”</a> on page 7.
Measuring range resolution	Max. 1 mm
Measuring frequency	55 kHz
Measuring cycle time	>2 s (dependent on the parameter adjustment)
Temperature coefficient	0.06 %/10K (average temperature coefficient of the zero signal - temperature error)
Vibration resistance	Mechanical vibrations with 4 g and 5...100 Hz (tested according to the guidelines of German Lloyd, GL directive 2)

### Electrical data

Operating voltage ( $U_n$ )	<ul style="list-style-type: none"> <li>• Without display/configuration module: <ul style="list-style-type: none"> <li>– 14...35 V DC</li> <li>– 14...30 V DC (Ex ia instrument)</li> </ul> </li> <li>• With display/configuration module: <ul style="list-style-type: none"> <li>– 20...35 V DC</li> <li>– 20...30 V DC (Ex ia instrument)</li> </ul> </li> </ul>
Power source (not supplied)	Limited power source according to UL/EN 60950-1 standards or limited energy circuit according to UL/EN 61010-1 §9.4
Output signal	4...20 mA/HART
Signal resolution	1.6 µA
Load resistor	$(U_n - U_{min})/0.022 A$
Fault signal	Current output: mA value unchanged, 20.5 mA, 22 mA or <3.6 mA (adjustable)
Max. output current	22 mA
Residual ripple (at DC)	<ul style="list-style-type: none"> <li>• &lt;100 Hz: <math>U_{ss} &lt; 1 V</math></li> <li>• 100 Hz...10 kHz: <math>U_{ss} &lt; 10 mV</math></li> </ul>

Voltage supply cable	<ul style="list-style-type: none"> <li>• Cable diameter: 5...9 mm</li> <li>• Wire cross-section (spring-loaded terminals): <ul style="list-style-type: none"> <li>– massive wire, stranded wire: 0.2...2.5 mm<sup>2</sup> (AWG 24...14)</li> <li>– stranded wire with end sleeve: 0.2...1.5 mm<sup>2</sup> (AWG 24...16)</li> </ul> </li> </ul>
----------------------	-------------------------------------------------------------------------------------------------------------------------------------------------------------------------------------------------------------------------------------------------------------------------------------------------------------------------------------------------

**Medium data**

Process temperature	-40 °C...+80 °C (-40 °F...176 °F)
Process pressure	Vessel pressure: -0.2...2 bar (-2.9...29.02 PSI/-20...200 kPa)

**Process/Port connection & communication**

Process connection	<ul style="list-style-type: none"> <li>• Thread G 2"</li> <li>• Thread NPT 2"</li> </ul>
Electrical connection	Cable glands M20 x 1.5

**Approvals and Certificates****Standards**

Degree of protection according to IEC/EN 60529	IP66/IP67 with M20 x 1.5 gland mounted and tightened
Overvoltage category according to IEC 61010-1	Category III
Protection class according to IEC 61010-1	Class II

**Directives**

CE directives	The applied standards, which verify conformity with the EU Directives, can be found on the EU Type Examination Certificate and/or the EU Declaration of conformity (if applicable)
NAMUR recommendations	<ul style="list-style-type: none"> <li>• NE21 – Electromagnetic compatibility of equipment</li> <li>• NE43 – Signal level for fault information from measuring transducers</li> <li>• NE53 - Compatibility of field devices and display/adjustment components</li> </ul>

**Approvals**

ATEX	EN 50014, EN 50020, EN 50284 Detailed information can be found in chapter <b>"2.1. ATEX-Certification"</b> on page 5.
------	--------------------------------------------------------------------------------------------------------------------------

**Environment and installation**

Ambient temperature	Operation and storage: <ul style="list-style-type: none"> <li>• -40 °C...+80 °C (-40 °F...+176 °F)</li> <li>• Restricted to -20 °C...+70 °C (-4 °F...+158 °F) if equipped with display/configuration module</li> </ul>
Relative air humidity	<ul style="list-style-type: none"> <li>• Operation: max. 75 %, without condensation</li> <li>• Storage: 20...85 %, without condensation</li> </ul>
Height above sea level	<ul style="list-style-type: none"> <li>• By default: max. 2000 m</li> <li>• With connected overvoltage protection: max. 5000 m</li> </ul>
Pollution degree	Degree 4 (when used with fulfilled housing protection)

1.) At -3 dB

2.) Time to output the correct level (with max. 10% deviation) after a sudden level change

## 2. Approvals

### 2.1. ATEX-Certification

**Note:**

Devices with Ex certification have different technical data, see **Supplement ATEX Type 8177** ▶ under user manual.

Certificate	Description
	<p><b>EU-Type Examination Certificate Number:</b> PTB 07 ATEX 2003X</p> <p><b>ATEX</b> II 1/2G resp. II 2G EEx ia IIC T6</p> <p>Measures to comply with ATEX requirements: refer to the <b>Supplement ATEX Type 8177</b> ▶ under user manual. The Ex. certification is only valid if the Bürkert device is used as described in the supplement ATEX. If unauthorized changes are made to the device, the Ex. certification becomes invalid.</p>

## 3. Materials

### 3.1. Chemical Resistance Chart – Bürkert resistApp

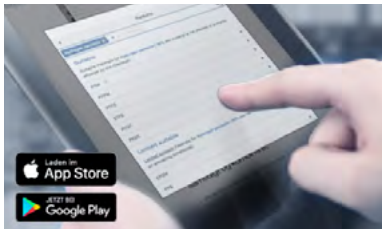

**Bürkert resistApp – Chemical Resistance Chart**

You want to ensure the reliability and durability of the materials in your individual application case? Verify your combination of media and materials on our website or in our resistApp.

[Start Chemical Resistance Check](#)

## 4. Dimensions

**Note:**

Dimensions in mm

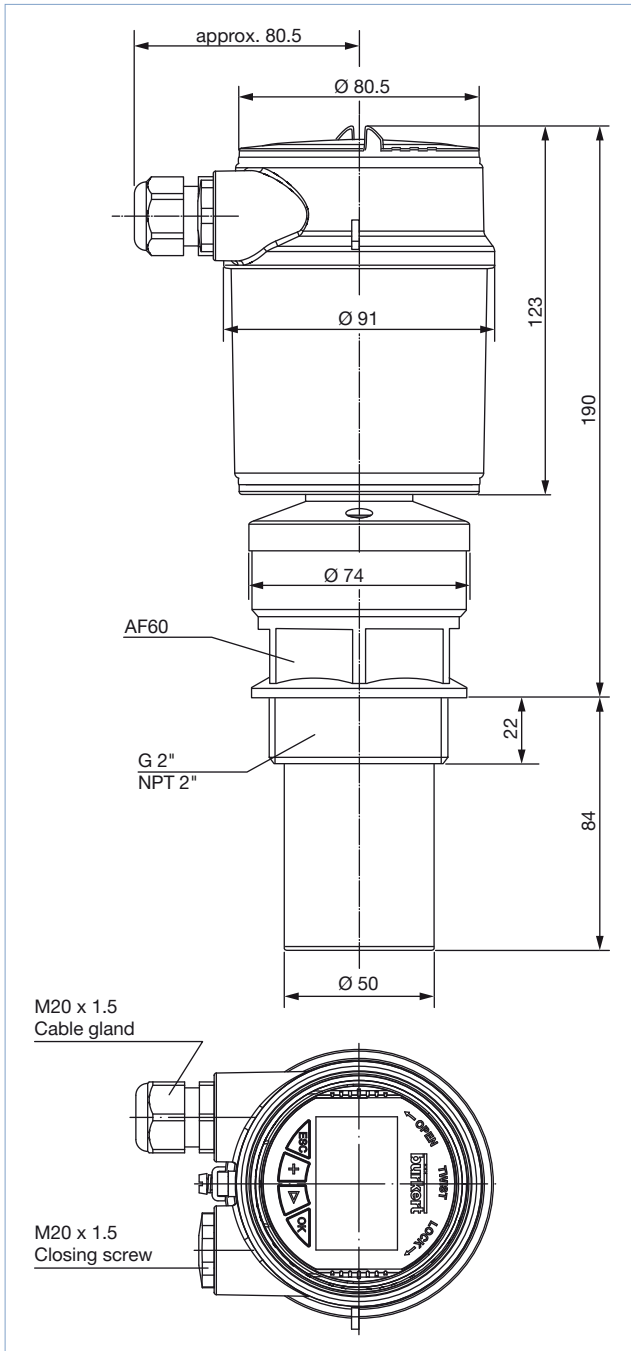

## 5. Performance specifications

### 5.1. Measurement deviation diagram

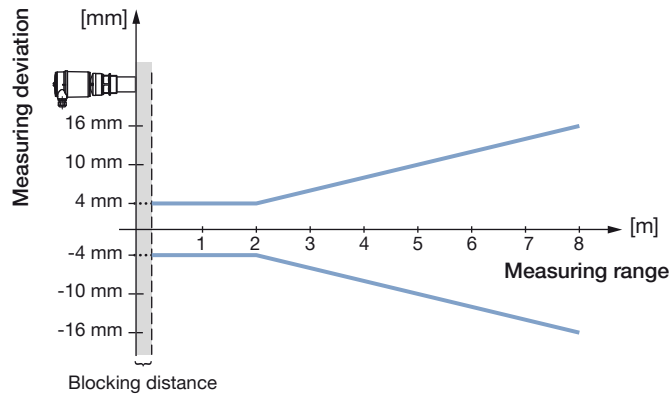

## 6. Product operation

### 6.1. Measuring principle

The transducer of the ultrasonic measuring device emits short ultrasonic pulses, at 55 kHz to the measured product. These pulses are reflected by the medium surface and received by the transducer as echoes. The running time of the ultrasonic pulses from emission to reception is proportional to the distance and hence to the level. An integrated temperature sensor detects the temperature in the vessel and compensates the influence of temperature on the signal running time. The determined level is converted into an output signal and transmitted as a measured value.

### 6.2. Product operation notes

#### Set up with display/configuration module

The measuring device is adjusted with the display/configuration module. The entered parameters are generally saved in the measuring device, Type 8177. Optionally, parameters may also be uploaded and downloaded with the display/configuration module.

Display/configuration module	Description
	<p>The display/configuration module can be inserted into the measuring device and removed again at any time. It is not necessary to interrupt the power supply. The measuring device is adjusted via the four keys of the display/configuration module.</p>

## 7. Ordering information

### 7.1. Bürkert eShop – Easy ordering and quick delivery



#### Bürkert eShop – Easy ordering and fast delivery

You want to find your desired Bürkert product or spare part quickly and order directly? Our online shop is available for you 24/7. Sign up and enjoy all the benefits.

[Order online now](#)

### 7.2. Bürkert product filter









#### Bürkert product filter – Get quickly to the right product



You want to select products comfortably based on your technical requirements? Use the Bürkert product filter and find suitable articles for your application quickly and easily.

[Try out our product filter](#)

### 7.3. Ordering chart

Description	Operating voltage	Output	Electrical connection	Article no.	Article no.
				with display/ configuration module	without display/ configuration module
G 2" mounting thread	14...35 V DC	4...20 mA/HART (2 wires)	Cable gland M20 x 1.5	558224 	559243 
NPT 2" mounting thread				558225 	559244 
Ex version – ATEX approval G 2" mounting thread	14...30 V DC			558226 	559245 

### 7.4. Ordering chart accessories

Description	Article no.
Set with 2 reductions M20 x 1.5/NPT $\frac{1}{2}$ + 2 neoprene flat seals for cable gland + 2 screw-plugs M20 x 1.5	551782 
Set with a display/configuration module, a transparent cover and a seal ring	559279 
Set with a transparent cover and a seal ring	561006 



# Bürkert – Close to You

For up-to-date addresses  
please visit us at  
[www.burkert.com](http://www.burkert.com)

DTS 1000086629 EN Version: S Status: RL (released | freigegeben | validé) printed: 18.12.2024

