



## Electromagnetic Insertion flowmeter

- Sensor without moving parts
- Indicates volume flow rate as well as volume
- Simulation of all output signals
- Clean in place (CIP) compatible, FDA-compliant materials
- Variant with electrodes made of alloy C22

Product variants described in the data sheet may differ from the product presentation and description.

### Can be combined with

	<b>Type 2030</b> 2/2-way diaphragm valve with pneumatic plastic actuator (Type CLASSIC)	▶
	<b>Type 2301</b> Pneumatically operated 2-way Globe Control Valve	▶
	<b>Type 8802</b> ELEMENT continuous control valve systems – overview	▶
	<b>Type 8644</b> AirLINE SP electropneumatic automation system	▶

### Type description

The electromagnetic flowmeter Type 8045 consists of an electronic module with a backlit display, operating buttons and a sensor made of PVDF or stainless steel. It is suitable for pipelines with nominal diameter of DN 06...DN 400 and neutral or aggressive liquids with conductivity greater than 20 µS/cm.

Type 8045 is fitted with a 4...20 mA current output and a digital output (preset as a pulse output). Some variants have 2 relay outputs and one digital input. Two independent totalisers allow the volume flow to be metered.

This flowmeter is available with either a G 2" connection for a PVDF sensor or a G 2" or clamp connection for a stainless steel sensor, both of which are designed for use with a Type S020 Insertion fitting.

The variant with stainless steel sensor is for applications with higher pressures (PN 16) and higher temperatures (110 °C). The variant with electrodes made of alloy C22 is suitable for applications with aggressive liquids (chemicals) and particularly for seawater applications.

## Table of contents

<b>1. General technical data</b>	<b>4</b>
<b>2. Approvals and conformities</b>	<b>7</b>
2.1. General notes .....	7
2.2. Conformity .....	7
2.3. Standards .....	7
2.4. Pressure Equipment Directive (PED) .....	7
Device used on a pipe.....	7
2.5. North America (USA/Canada) .....	7
2.6. Foods and beverages/Hygiene .....	7
<b>3. Materials</b>	<b>8</b>
3.1. Bürkert resistApp .....	8
3.2. Material specifications .....	8
<b>4. Dimensions</b>	<b>9</b>
4.1. Flowmeter .....	9
With G 2" process connection.....	9
With clamp process connection.....	10
4.2. Flowmeter installed in an Insertion fitting Type S020.....	10
With G 2" process connection.....	10
With clamp process connection.....	11
<b>5. Performance specifications</b>	<b>11</b>
5.1. Pressure temperature diagram .....	11
Flowmeter with a PVDF sensor.....	11
Flowmeter with a stainless steel sensor.....	12
<b>6. Product installation</b>	<b>12</b>
6.1. Installation notes .....	12
6.2. Mounting options.....	13
<b>7. Product operation</b>	<b>13</b>
7.1. Measuring principle .....	13
7.2. Functional overview .....	14
Display and operating keys.....	14
Operating levels .....	15
<b>8. Product design and assembly</b>	<b>16</b>
8.1. Product assembly .....	16
<b>9. Networking and combination with other Bürkert products</b>	<b>17</b>
9.1. Networking and combination of the device.....	17
9.2. Combination of the device with available Type S020 Insertion fittings DN.....	17
<b>10. Ordering information</b>	<b>18</b>
10.1. Bürkert eShop .....	18
10.2. Recommendation regarding product selection.....	18
Flowmeter with G 2" process connection .....	18
Flowmeter with clamp process connection.....	18
10.3. Bürkert product filter.....	18
10.4. Ordering chart .....	19
Flowmeter with G 2" process connection .....	19

Flowmeter with clamp process connection .....20

10.5. Ordering chart accessories.....20

DTS 1000011093 EN Version: AI Status: RL (released | freigegeben | validé) printed: 04.04.2025

## 1. General technical data

**Note:**

If the device is mounted in a humid environment or outside, then the maximum voltage allowed is **35 V DC** instead of 36 V DC.

**Product properties**

**Material**

Make sure the device materials are compatible with the fluid you are using.  
Further information can be found in chapter **“3.1. Bürkert resistApp” on page 8.**

Further information on the materials can be found in chapter **“3.2. Material specifications” on page 8.**

**Non-wetted parts**

Lid	<ul style="list-style-type: none"> <li>• Variant with flow sensor in PVDF: PC</li> <li>• Variant with flow sensor in stainless steel: PSU</li> </ul>
Front panel film	Polyester
Cover	<ul style="list-style-type: none"> <li>• Variant with flow sensor in PVDF: PC</li> <li>• Variant with flow sensor in stainless steel: back PPA (glass fibre reinforced)</li> </ul>
Housing	<ul style="list-style-type: none"> <li>• Variant with flow sensor in PVDF: PC (glass fibre reinforced)</li> <li>• Variant with flow sensor in stainless steel: back PPA (glass fibre reinforced)</li> </ul>
Screw	Stainless steel
Union nut	<ul style="list-style-type: none"> <li>• Variant with flow sensor in PVDF: PC</li> <li>• Variant with flow sensor in stainless steel: back PPA (glass fibre reinforced)</li> </ul>
Mounting ring	Polysulphone, glass fibre reinforced
Seal	NBR, silicone
Armature	Stainless steel 1.4404/316L (for flowmeter with clamp process connection, over the clamp)
Cable gland	PA with neoprene seal

**Wetted parts**

Clamp	Stainless steel 1.4404/316L
Sensor armature	<ul style="list-style-type: none"> <li>• PVDF</li> <li>• Stainless steel 1.4404/316L</li> </ul>
Electrode holder	Only with variant with flow sensor in stainless steel: PEEK (conform to FDA)
Electrode	<ul style="list-style-type: none"> <li>• Stainless steel 1.4404/316L</li> <li>• Alloy C22</li> </ul>
Earth ring	Only with variant with flow sensor in PVDF: <ul style="list-style-type: none"> <li>• Stainless steel 1.4404/316L</li> <li>• Alloy C22</li> </ul>
Seal	<ul style="list-style-type: none"> <li>• For flowmeter with G 2" process connection:                     <ul style="list-style-type: none"> <li>– FKM</li> <li>– EPDM (conform to FDA)</li> </ul> </li> <li>• For flowmeter with clamp process connection: (to be ordered separately, further information can be found in chapter <b>“10.5. Ordering chart accessories” on page 20.</b>)                     <ul style="list-style-type: none"> <li>– EPDM</li> <li>– FEP</li> </ul> </li> </ul>

Surface quality	For flowmeter with clamp process connection: Ra < 0.8 µm
Compatibility	<ul style="list-style-type: none"> <li>• For flowmeter with G 2" process connection: Any pipe from DN 06...DN 400 which is fitted with Bürkert Type S020 Insertion fitting with G 2" sensor connection.</li> <li>• For flowmeter with clamp process connection: Any pipe from DN 32...DN 100 which is fitted with Bürkert Type S020 Insertion fitting with clamp sensor connection.</li> </ul> For the selection of the nominal diameter of the Insertion fittings, see <b>data sheet Type S020</b> ▶.
Pipe diameter	<ul style="list-style-type: none"> <li>• For flowmeter with G 2" process connection: DN 06...DN 400</li> <li>• For flowmeter with clamp process connection: DN 32...DN 100</li> </ul>
Dimensions	Further information can be found in chapter <b>“4. Dimensions” on page 9.</b>
Measuring element	Electrodes
Measuring principle	Electromagnetic
Measuring range	<ul style="list-style-type: none"> <li>• Flow rate: 0.4...75000 l/min</li> <li>• Flow velocity: 0.2...10 m/s</li> </ul>

DTS 1000011093 EN Version: AI Status: RL (released | freigegeben | validé) printed: 04.04.2025

Performance data	
Measurement deviation	<ul style="list-style-type: none"> <li>Teach-in: <math>\pm 0.5\%</math> of the measured value<sup>1)</sup> at teach-in flow rate value</li> <li>Standard K-factor: <math>\pm 3.5\%</math> of the measured value<sup>1)</sup></li> </ul>
Linearity	$\pm 0.5\%$ of full scale <sup>1)</sup>
Repeatability	$\pm 0.25\%$ of the measured value <sup>1)</sup>
4...20 mA output uncertainty	$\pm 1\%$ of range
Electrical data	
Operating voltage	18...36 V DC $\pm 0.5\%$ , filtered and regulated (3 wires)
Power source (not supplied)	Limited power source according to UL/EN 62368-1 standards or limited energy circuit according to UL/EN 61010-1 paragraph 9.4
DC reverse polarity protection	Yes
Current consumption	$\leq 300$ mA (at 18 V DC)
Input	DI1 <ul style="list-style-type: none"> <li>Supply voltage: 18...36 V DC</li> <li>Input impedance: 15 k<math>\Omega</math></li> <li>min. pulse duration: 200 ms</li> <li>Galvanic insulation, protected against polarity reversals of DC and voltage spikes</li> </ul>
Output	<ul style="list-style-type: none"> <li>Transistor (digital output DO1):               <ul style="list-style-type: none"> <li>Type: NPN or PNP (wiring dependent), open collector</li> <li>Function: pulse output (by default), user configurable</li> <li>0...250 Hz, 5...36 V DC, 100 mA max.</li> <li>Duty cycle (pulse duration/period) if frequency &gt; 2 Hz: <math>\frac{1}{2}</math></li> <li>Min. pulse duration if frequency &lt; 2 Hz: 250 ms</li> <li>Galvanic insulation, protected against polarity reversals of DC and short-circuits</li> </ul> </li> <li>Relay (digital outputs DO2 and DO3):               <ul style="list-style-type: none"> <li>2 normally open, freely adjustable (hysteresis by default)</li> <li>Non UL recognized device: 250 V AC/3 A or 40 V DC/3 A (resistive load)</li> <li>UL recognized device: 30 V AC/42 V<sub>peak</sub>/3 A or 60 V DC/1 A</li> <li>Max. cutting power of 750 VA (resistive load)</li> <li>Life span of min. 100000 cycles</li> </ul> </li> <li>Current (analogue output AO1):               <ul style="list-style-type: none"> <li>4...20 mA</li> <li>Sink or source (by wiring)</li> <li>22 mA to indicate a fault</li> <li>Max. loop impedance: 1300 <math>\Omega</math> at 36 V DC; 1000 <math>\Omega</math> at 30 V DC; 700 <math>\Omega</math> at 24 V DC; 450 <math>\Omega</math> at 18 V DC</li> </ul> </li> </ul>
Voltage supply cable	<ul style="list-style-type: none"> <li>Shielded</li> <li>External diameter (cable): 6...12 mm (1 cable per cable gland) or 4...5 mm when using a multi-way seal (2 cables per cable gland)</li> <li>Cross section of wires: 0.5...1.5 mm<sup>2</sup></li> </ul>
Medium data	
Fluid temperature	<ul style="list-style-type: none"> <li>Variant with flow sensor in PVDF: 0...+ 80 °C (+ 32...+ 176 °F) (depends on Insertion fitting)</li> <li>Variant with flow sensor in stainless steel: - 15...+ 110 °C (+ 5...+ 232 °F) (depends on Insertion fitting)</li> </ul> Further information can be found in chapter <b>"5.1. Pressure temperature diagram"</b> on page 11 and in the data sheet of the fitting, see <b>data sheet Type S020</b> ►.
Fluid pressure	<ul style="list-style-type: none"> <li>Variant with flow sensor in PVDF: max. PN 10 (145.1 PSI)</li> <li>Variant with flow sensor in stainless steel:               <ul style="list-style-type: none"> <li>Max. PN 10 (145.1 PSI) (with plastic Insertion fitting)</li> <li>Max. PN 16 (232.16 PSI) (with metal Insertion fitting)</li> </ul> </li> </ul> Further information can be found in chapter <b>"5.1. Pressure temperature diagram"</b> on page 11 and in the data sheet of the Insertion fitting, see <b>data sheet Type S020</b> ►.
Viscosity	< 1000 mPa.s
Minimum conductivity	20 $\mu$ S/cm

### Process/Pipe connection and communication

Process connection	<ul style="list-style-type: none"> <li>• G 2" for use with Type S020 Insertion fitting</li> <li>• Clamp for use with Type S020 Insertion fitting or any pipe equipped with our clamp sensor connection.</li> </ul> See <b>data sheet Type S020</b> ▶ for more information.
Electrical connection	2 cable glands M20 × 1.5

### Approvals and conformities

#### Directives

CE directive	Further information on the CE Directive can be found in chapter <b>"2.3. Standards"</b> on page 7.
Pressure equipment directive	Complying with article 4, paragraph 1 of 2014/68/EU directive Further information on the pressure equipment directive can be found in chapter <b>"2.4. Pressure Equipment Directive (PED)"</b> on page 7.
North America (USA/Canada)	UL Recognized for the USA and Canada
Foods and beverages/Hygiene	<ul style="list-style-type: none"> <li>• FDA declaration of conformity (for stainless steel or PVDF sensor with FKM or EPDM seal)</li> <li>• ECR1935/2004 declaration (only for stainless steel sensor with EPDM seal)</li> </ul>

### Environment and installation

Ambient temperature	<ul style="list-style-type: none"> <li>• Operation: - 10...+ 60 °C (+ 14...+ 140 °F)</li> <li>• Storage: - 20...+ 60 °C (- 4...+ 140 °F)</li> </ul>
Relative air humidity	≤ 80 %, without condensation
Height above sea level	Max. 2000 m
Operating condition	Continuous
Equipment mobility	Fixed
Application range	Indoor and outdoor Protect the device against electromagnetic interference, ultraviolet rays and, when installed outdoors, against the effects of climatic conditions.
Degree of protection <sup>2.)</sup> according to IEC/EN 60529	IP65 with the following conditions met: <ul style="list-style-type: none"> <li>• device wired</li> <li>• cover and lid screwed tight</li> <li>• cable glands mounted and tightened</li> <li>• with blind plug on unused cable glands</li> </ul>
Installation category	Category I according to UL/EN 61010-1
Pollution degree	Degree 2 according to UL/EN 61010-1

1.) Under reference conditions i.e. measuring medium = water, ambient and water temperature = + 20 °C (+ 68 °F), observing the minimum the minimum inlet and outlet sections and the appropriate inner diameter of the pipe.

2.) Not evaluated by UL

## 2. Approvals and conformities

### 2.1. General notes

- The approvals and conformities listed below must be stated when making enquiries. This is the only way to ensure that the product complies with all required specifications.
- Not all available variants of the device can be supplied with the below mentioned approvals or conformities.

### 2.2. Conformity

In accordance with the Declaration of Conformity, the product is compliant with the EU Directives.

### 2.3. Standards

The applied standards which are used to demonstrate compliance with the EU Directives are listed in the EU-Type Examination Certificate and/or the EU Declaration of Conformity.

### 2.4. Pressure Equipment Directive (PED)

The device conforms to article 4, paragraph 1 of the Pressure Equipment Directive (PED) 2014/68/EU under the following conditions:

#### Device used on a pipe

##### Note:

- The data in the table is independent of the chemical compatibility of the material and the fluid.
- PS = maximum admissible pressure (in bar), DN = nominal diameter of the pipe

Type of fluid	Conditions
Fluid group 1, Article 4, Paragraph 1.c.i	DN ≤ 25
Fluid group 2, Article 4, Paragraph 1.c.i	DN ≤ 32 or PS*DN ≤ 1000
Fluid group 1, Article 4, Paragraph 1.c.ii	DN ≤ 25 or PS*DN ≤ 2000
Fluid group 2, Article 4, Paragraph 1.c.ii	DN ≤ 200 or PS ≤ 10 or PS*DN ≤ 5000

### 2.5. North America (USA/Canada)

Approval	Description
	<b>Optional: UL Recognized for the USA and Canada</b> The products are UL Recognized for the USA and Canada according to: <ul style="list-style-type: none"> <li>• UL 61010-1</li> <li>• CAN/CSA-C22.2 No. 61010-1</li> </ul>

### 2.6. Foods and beverages/Hygiene

Conformity	Description
FDA	<b>FDA – Code of Federal Regulations</b> Only devices with stainless steel or PVDF sensor and FKM or EPDM seals are compliant with the Code of Federal Regulations published by the FDA (Food and Drug Administration, USA) according to the manufacturer's declaration.
	<b>EC Regulation 1935/2004 of the European Parliament and of the Council</b> Only devices with stainless steel sensor and EPDM seals are compliant with EC Regulation 1935/2004/EC according to the manufacturer's declaration.

### 3. Materials

#### 3.1. Bürkert resistApp

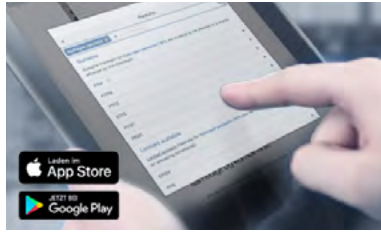

#### Bürkert resistApp – Chemical resistance chart

You want to ensure the reliability and durability of the materials in your individual application case? Verify your combination of media and materials on our website or in our resistApp.

[Start chemical resistance check](#)

#### 3.2. Material specifications

Flowmeter with

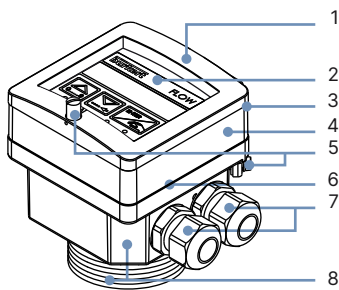

- G 2" process connection and sensor holder in PVDF or

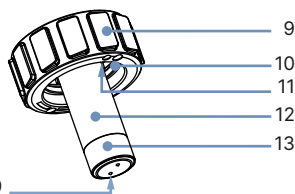

- G 2" process connection and sensor holder in stainless steel or

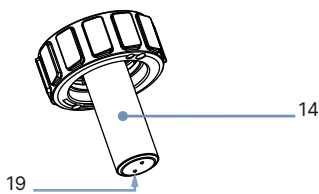

- Clamp process connection and with sensor holder in stainless steel

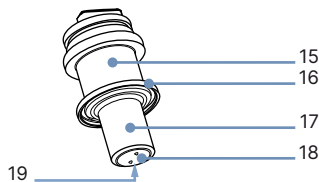

No.	Element	Material
1	Lid	<ul style="list-style-type: none"> <li>PC for variant with flow sensor in PVDF</li> <li>PSU for variant with flow sensor in stainless steel</li> </ul>
2	Front panel foil	Polyester
3	Seal	Silicone
4	Cover	<ul style="list-style-type: none"> <li>PC for variant with flow sensor in PVDF</li> <li>Black PPA, glass fibre reinforced for variant with flow sensor in stainless steel</li> </ul>
5	Screws	Stainless steel
6	Seal	NBR
7	Cable glands	PA with neoprene seal
8	Housing	<ul style="list-style-type: none"> <li>PC, glass fibre reinforced for variant with flow sensor in PVDF</li> <li>Black PPA, glass fibre reinforced for variant with flow sensor in stainless steel</li> </ul>
9	Nut	<ul style="list-style-type: none"> <li>PC for variant with flow sensor in PVDF</li> <li>PPA glass fibre reinforced for variant with flow sensor in stainless steel</li> </ul>
10	Mounting ring (open)	Polysulphone, glass fibre reinforced
11	Seal	<ul style="list-style-type: none"> <li>FKM (approved FDA)</li> <li>EPDM included, but not mounted (conform to FDA)</li> </ul>
12	Sensor holder	PVDF
13	Earth ring	<ul style="list-style-type: none"> <li>Stainless steel 1.4404/316L or</li> <li>Alloy C22</li> </ul>
14	Sensor holder	Stainless steel 1.4404/316L
15	Holder	Stainless steel 1.4404/316L
16	Clamp	Stainless steel 1.4404/316L
17	Sensor holder	Stainless steel 1.4404/316L
18	Electrode holder	PEEK (conform to FDA)
19	Electrodes	<ul style="list-style-type: none"> <li>Stainless steel 1.4404/316L or</li> <li>Alloy C22</li> </ul>



## 4. Dimensions

### 4.1. Flowmeter

With G 2" process connection

**Note:**

- Dimensions in mm, unless otherwise stated
- The length of the flow probe depends on the used Insertion fitting Type S020 and its nominal diameter.

See **data sheet Type S020** ▶ for more information or chapter **"9.2. Combination of the device with available Type S020 Insertion fittings DN"** on page 17.

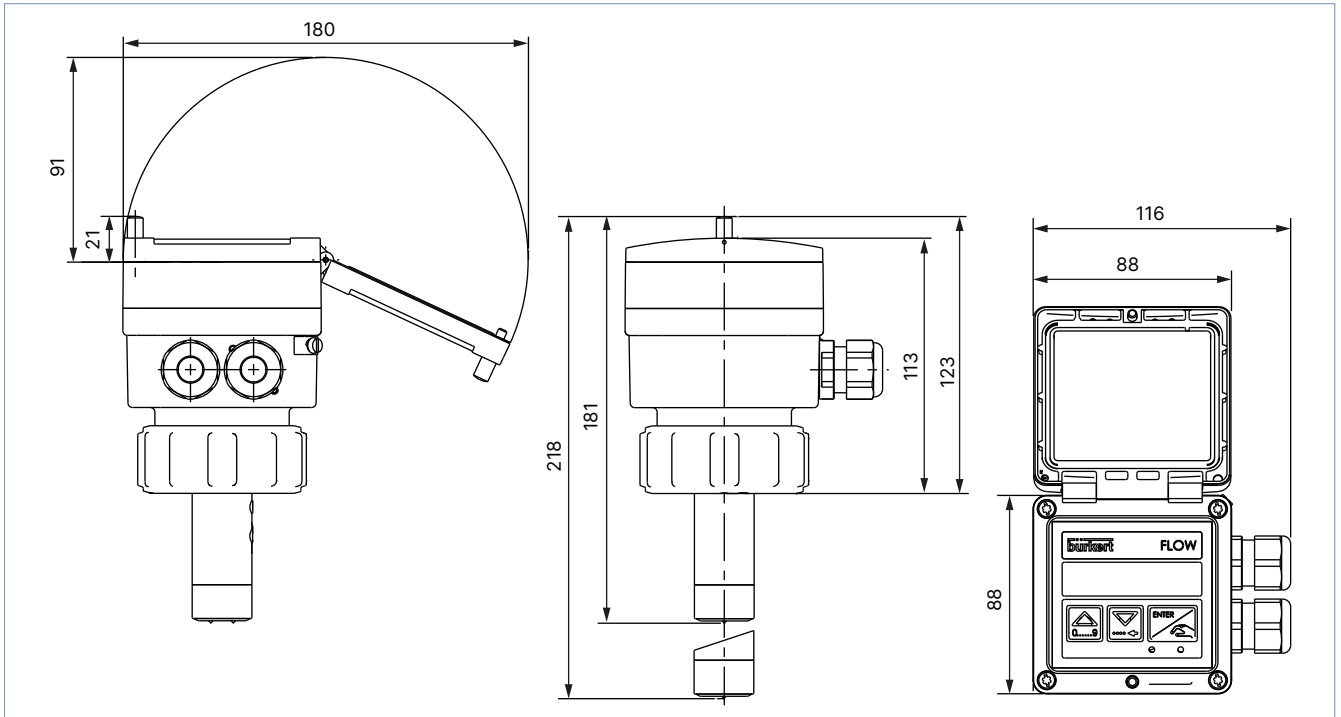

**With clamp process connection**

**Note:**

Dimensions in mm, unless otherwise stated

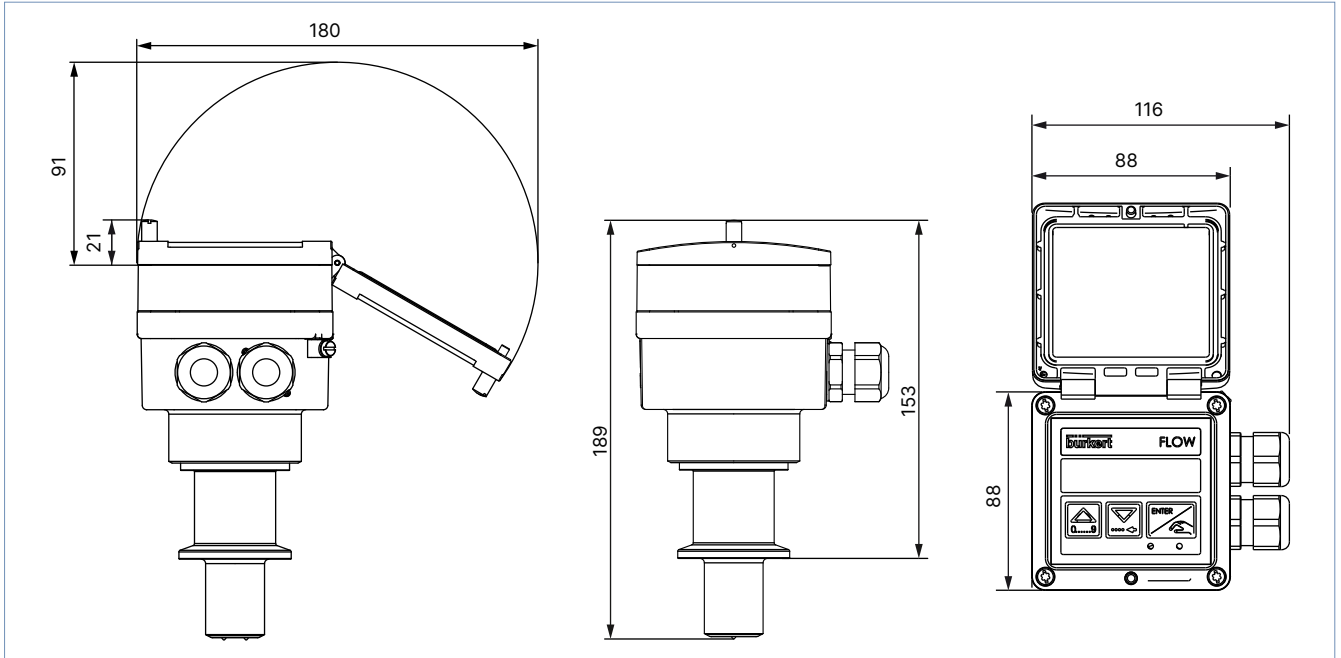

**4.2. Flowmeter installed in an Insertion fitting Type S020**

**With G 2" process connection**

**Note:**

Dimensions in mm, unless otherwise stated

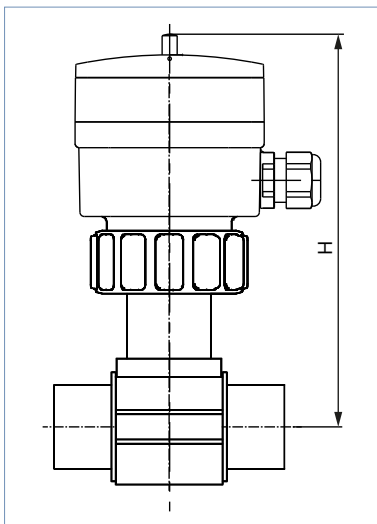

DN	H			
	T-Fitting	Saddle	Plastic spigot	Metal spigot
06	182	-	-	-
08	182	-	-	-
15	187	-	-	-
20	185	-	-	-
25	185	-	-	-
32	188	-	-	-
40	192	-	-	188
50	198	223	-	193
65	198	222	206	199
80	-	226	212	204
100	-	231	219	214
110	-	227	-	-
125	-	234	254	225
150	-	244	261	236
180	-	268	-	-
200	-	280	282	257
250	-	-	300	317
300	-	-	312	336
350	-	-	325	348
400	-	-	340	-

DTS 1000011093 EN Version: AI Status: RL (released | freigegeben | validé) printed: 04.04.2025

**With clamp process connection**

**Note:**

Dimensions in mm, unless otherwise stated

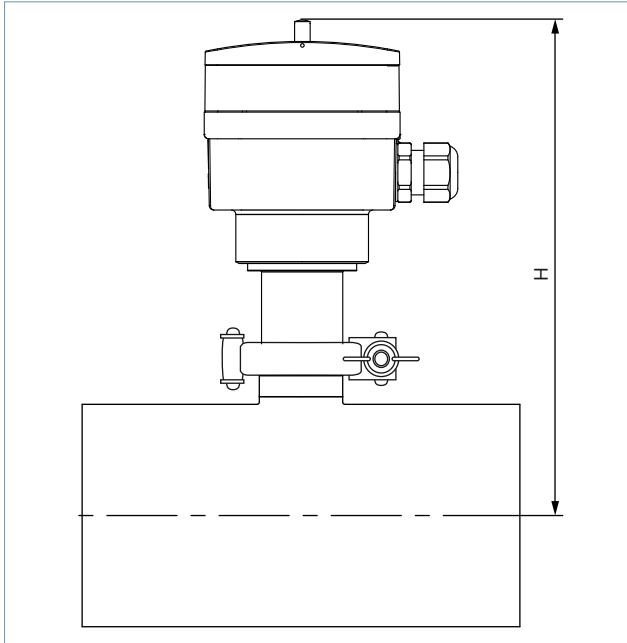

DN	H
	T-Fitting
32	200
40	205
50	210
65	218
80	224
100	230

DTS 1000011093 EN Version: AI Status: RL (released | freigegeben | validé) printed: 04.04.2025

## 5. Performance specifications

### 5.1. Pressure temperature diagram

**Flowmeter with a PVDF sensor**

**Note:**

Take into account the dependence between fluid pressure and temperature according to the fitting and flowmeter material shown in the following diagram.

See **data sheet Type S020** ▶ for more information.

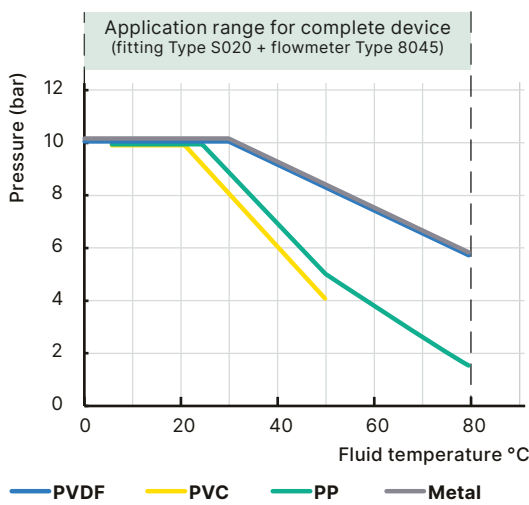

**Flowmeter with a stainless steel sensor**

**Note:**

Take into account the dependence between fluid pressure and temperature according to the fitting and flowmeter material shown in the following diagram.

See **data sheet Type S020** ▶ for more information.

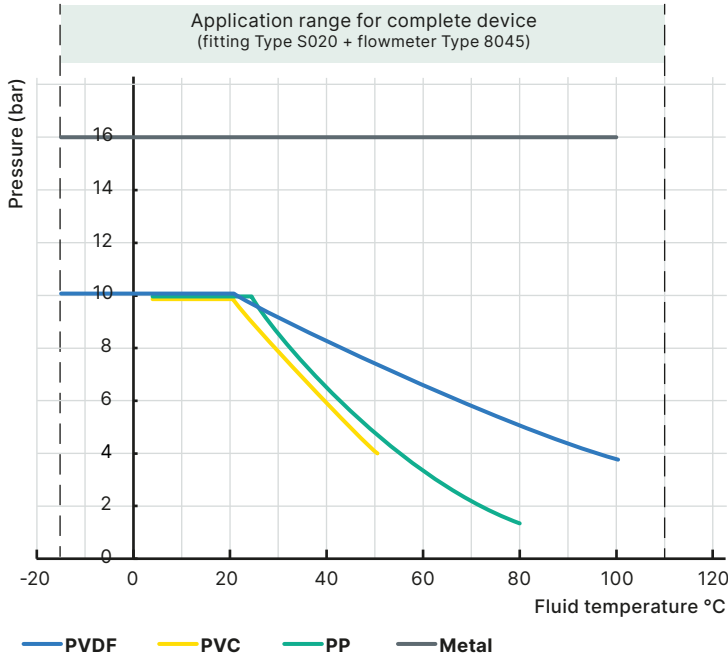

DTS 1000011093 EN Version: AI Status: RL (released | freigegeben | validé) printed: 04.04.2025

**6. Product installation**

**6.1. Installation notes**

**Note:**

The device is not suitable for use in gaseous media and steam.

Minimum straight distances upstream and downstream of the sensor must be observed. These stabilizing distances depend on the pipe's design. Increasing these distances or installing a flow conditioner may be necessary to obtain the best accuracy. For more information, refer to EN ISO 5167-1.

EN ISO 5167-1 specifies the straight inlet and outlet distances that must be complied with when installing fittings in pipe lines in order to achieve calm flow conditions. The most commonly used elements that could lead to turbulence in the flow are shown below. The related minimum inlet and outlet distances that ensure a calm flow are also specified.

Make sure that the measuring conditions at the point of measurement are calm and problem-free.

**DN = Orifice**

**Fluid direction →**

Regulating valve<sup>1)</sup>

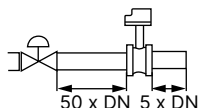

2 x 90° elbow joint

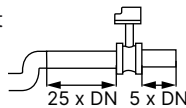

Expansion<sup>2)</sup>

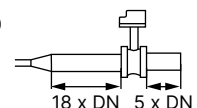

2 x 90° elbow joint  
3 dimensional

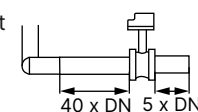

90° elbow joint  
or T-piece

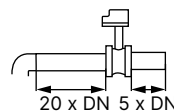

Reduction

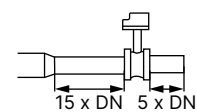

1.) If the valve cannot be mounted after the measuring device, the minimal distances have to be respected.  
2.) If an expansion cannot be avoided, the minimal distances have to be respected.  
Please note minimum flow velocity

The device can be installed in either horizontal or vertical pipes, but following additional conditions should be respected:

- The pipe always has to be filled with fluid at all times near the device.
- The pipe design must be such that no air bubbles or cavitation can form within the medium near the device at any time.

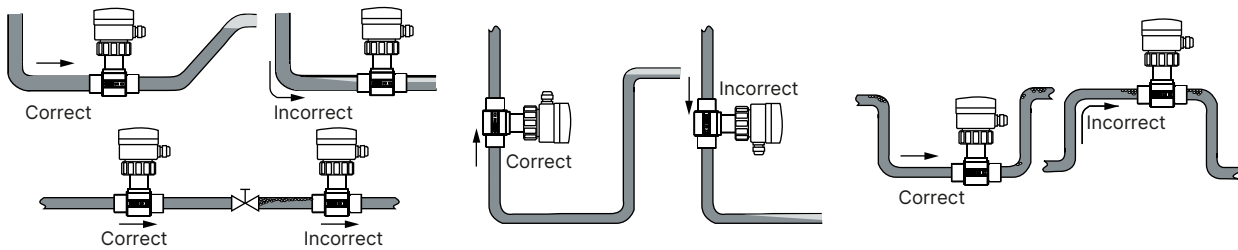

Pressure and temperature ratings must be respected according to the selected fitting material. The suitable pipe size is selected using the diagram in the chapter "Nominal size selection" of the **data sheet Type S020** ▶.

## 6.2. Mounting options

It is advisable to mount the flowmeter at a 45° angle to the horizontal centre of the pipe to avoid having deposits on the electrodes and false measurements due to air bubbles

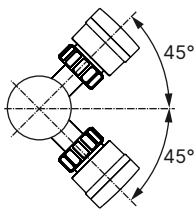

## 7. Product operation

### 7.1. Measuring principle

The E-shaped magnetic system inside the sensor induces a magnetic field into the fluid, which is perpendicular to the direction of flow. Two electrodes are in galvanic contact with the liquid.

Based on the Faraday law a voltage can be measured between these electrodes once a liquid (min. conductivity of 20 µS/cm) flows along the pipe. This voltage is proportional to the flow velocity.

Using the K-factor for the individual pipe diameter the speed of flow is converted into volume per time.



## 7.2. Functional overview

### Display and operating keys

The display is used to:

- Read the value of certain parameters e.g. the measured flow rate, the main totalizer
- Set parameters of the device by means of 3 keys
- Read the configuration of the device
- Get notification of some events.

Display and operating keys	No.	Description
	1	"Back" key: <ul style="list-style-type: none"> <li>• To change the value (0...9) of the selected digit</li> <li>• To go back to the previous function</li> </ul>
	2	"Next" key: <ul style="list-style-type: none"> <li>• To select the digit at the left</li> <li>• To go to the next function</li> <li>• To read messages</li> </ul>
	3	"Confirm" key: <ul style="list-style-type: none"> <li>• To confirm the function displayed</li> <li>• To confirm the parameters set</li> </ul>
	4	Status LED of relay DO3 (LED ON = contact closed)
	5	Status LED of relay DO2 (LED ON = contact closed)
	6	Status of device <ul style="list-style-type: none"> <li>• Green: the device operates correctly.</li> <li>• Orange: a warning messages is generated in the information menu.</li> <li>• Red: A fault message is generated and a 22 mA current is sent on the current output if activated.</li> <li>• Blinking, whatever the colour:                             <ul style="list-style-type: none"> <li>– The DI1 digital input is active or</li> <li>– A check for the correct behaviour of the outputs is running or</li> <li>– A flow zero point calibration procedure is running or</li> <li>– The daily totalizer is kept at zero.</li> </ul> </li> </ul>

The device can be calibrated by means of the K factor (proportionality factor) of the fitting, or via the teach-in function. User adjustments, such as engineering units, outputs and filter are carried out on site.

DTS 1000011093 EN Version: AI Status: RL (released | freigegeben | valide) printed: 04.04.2025

**Operating levels**

The device has 2 operating levels:

- The process level
- The configuration level, which comprises the parameters, the test and the information menus

Operating level	Functions
Process	This level allows: <ul style="list-style-type: none"> <li>• to read                             <ul style="list-style-type: none"> <li>– the value of the measured flow</li> <li>– the value of the 4...20 mA output</li> <li>– the value of the main totalizer</li> <li>– the value of the daily totalizer</li> </ul> </li> <li>• to reset the daily totalizer</li> <li>• to access to the parameters, test and information menus of the configuration level</li> </ul>
Configuration - parameters menu	This level allows to set the required operation parameters: <ul style="list-style-type: none"> <li>– language</li> <li>– engineering units (international measuring units)</li> <li>– K factor/Teach function</li> <li>– 4...20-mA-current output (AO1)</li> <li>– detection of flow direction possible</li> <li>– transistor output (DO1)</li> <li>– 2 relays (DO2 and DO3 - if equipped)</li> <li>– ON/OFF digital input (DI1 - if equipped)</li> <li>– filter (damping)</li> <li>– resetting both totalizers</li> <li>– electric network frequency</li> <li>– low flow “Cut Off“</li> <li>– brightness of the display (backlight)</li> </ul>
Configuration - test menu	This level allows <ul style="list-style-type: none"> <li>• to adjust the Offset and Span of the 4...20 mA current output</li> <li>• to calibrate the flow zero point of the device</li> <li>• to check the correct operating of the outputs</li> <li>• to set the coefficient Kw of the flow sensor to adjust the device accuracy</li> <li>• to set the flow rate range outside which a warning message is generated</li> </ul>
Configuration - Information menu	This level allows to read the fault and warning messages generated

DTS 1000011093 EN Version: AI Status: RL (released | freigegeben | validé) printed: 04.04.2025

## 8. Product design and assembly

### 8.1. Product assembly

**Note:**

- The device Type 8045 is installed into a Bürkert Insertion fitting Type S020 and fastened with a union nut.
- The Insertion fitting Type S020 ensures simple installation into pipes from DN 06...DN 400, see **data sheet Type S020** ▶ for more information.

The device is equipped with a PVDF or stainless steel measurement sensor which comprises two electrodes and a magnetic system and is available in long or short variant (dependent on the size of the used fitting). The sensor holder is plugged-in to the housing, which contains containing the electronic module.

The connection of the device to the process is made depending on the variant, either by a G 2" nut or a clamp.

The electrical connection is provided via two cable glands on a 6-pin terminal block.

Compact flowmeter with a G 2" process connection



Insertion fitting with a G 2" sensor connection Type S020



Complete device with a G 2" process connection for flow measurement Type 8045

Fitting in stainless steel with a G 2" sensor connection Type S020 (only example)

Compact flowmeter with a clamp process connection

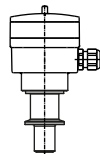

Clamp collar and seal (accessories, to be ordered separately)



Insertion fitting with a clamp sensor connection Type S020

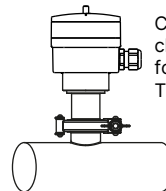
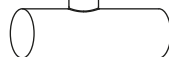

Complete device with a clamp process connection for flow measurement Type 8045



## 9. Networking and combination with other Bürkert products

### 9.1. Networking and combination of the device

Example:

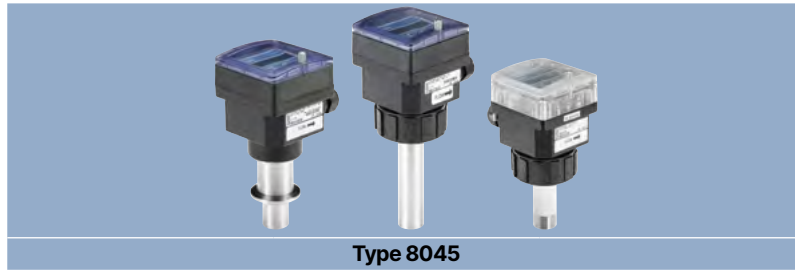

Type 8045

4...20 mA output		Relay output			
<b>Type 8802 ▶</b> (2301 & 8693) ELEMENT Continuous control valve systems	<b>Type 6281 ▶</b> Servo-assisted 2/2-way diaphragm valve	<b>Type 6213 ▶</b> Servo-assisted 2/2-way diaphragm valve	<b>Type 6027 ▶</b> Direct acting 2/2-way plunger valve	<b>Type S020 ▶</b> Insertion fitting	

### 9.2. Combination of the device with available Type S020 Insertion fittings DN

Fitting with G 2" process connection		DN06	DN08	DN32	DN50	DN65	DN100	DN200	DN350	DN400
Available S020 fittings DN	T-fitting	1.)		short sensor						
	Welding socket				short sensor			long sensor		
	Fusion spigot					short sensor		long sensor		
	Screw-on spigot							long sensor		
	Saddle				long sensor					
Fitting with clamp process connection										
	T-fitting or welding socket									

1.) DN06 and DN08: S020 in stainless steel only and 8045 with stainless steel sensor recommended

DTS 1000011093 EN Version: AI Status: RL (released | freigegeben | valide) printed: 04.04.2025

## 10. Ordering information

### 10.1. Bürkert eShop



#### Bürkert eShop – Easy ordering and quick delivery

You want to find your desired Bürkert product or spare part quickly and order directly? Our online shop is available for you 24/7. Sign up and enjoy all the benefits.

[Order online now](#)

### 10.2. Recommendation regarding product selection

#### Flowmeter with G 2" process connection

A complete 8045 flowmeter consists of a 8045 flowmeter with G 2" process connection and a Bürkert Type S020 Insertion fitting with G 2" sensor connection .

See [data sheet Type S020](#) ▶ for more information.

Two different components must be ordered in order to select a complete device. The following information is required:

- **Article no.** of the desired compact flowmeter with G 2" process connection Type 8045 (see chapter "[Flowmeter with G 2" process connection](#)" on page 19)
- **Article no.** of the selected Type S020 Insertion fitting with G 2" sensor connection (see [data sheet Type S020](#) ▶)

#### Flowmeter with clamp process connection

A complete 8045 flowmeter consists of a 8045 flowmeter with clamp process connection and a Bürkert Type S020 Insertion fitting with clamp sensor connection .

See [data sheet Type S020](#) ▶ for more information.

Four different components must be ordered in order to select a complete device. The following information is required:

- **Article no.** of the desired flowmeter with clamp process connection Type 8045 (see chapter "[Flowmeter with clamp process connection](#)" on page 20)
- **Article no.** of the selected Type S020 Insertion fitting with clamp sensor connection (see [data sheet Type S020](#) ▶)
- **Article no.** of the selected fitting/flowmeter seal, in EPDM or FEP (see chapter "[10.5. Ordering chart accessories](#)" on page 20)
- **Article no.** of the clamp collar (see chapter "[10.5. Ordering chart accessories](#)" on page 20)

### 10.3. Bürkert product filter



#### Bürkert product filter – Get quickly to the right product

You want to select products comfortably based on your technical requirements? Use the Bürkert product filter and find suitable articles for your application quickly and easily.

[Try out our product filter](#)

### 10.4. Ordering chart

#### Flowmeter with G 2" process connection

**Note:**

The following variants

- have at least
  - a FKM process seal
  - an 18...36 V DC operating voltage
  - a 4...20 mA current output (AO1) and
  - a digital output (DO1)
- are supplied with an accessories set (Article no. 551775) including an EPDM seal.

Further information regarding the sets can be found in chapter "10.5. Ordering chart accessories" on page 20.

Sensor variant	Input	Output	Material		Approval and conformity			Electrical connection	Article no.
			Housing	Sensor / Earth ring / Electrode	UL	FDA	ECR1935/2004 <sup>1)</sup>		
Short	–	–	PC	PVDF / Stainless steel / Stainless steel	–	Yes	–	2 cable glands M20 × 1.5	426498
Long					UL Recognized				570470
					–				426499
Short					UL Recognized				570471
				–	558675				
Long				PVDf / Alloy C22 / Alloy C22	–	–			570484
					UL Recognized				558676
					–				570485
	UL Recognized	570485							
Short	1 digital input (DI1)	2 relay outputs (DO2, DO3)	PC	PVDF / Stainless steel / Stainless steel	–	Yes		426506	
Long					UL Recognized			570472	
					–			426507	
Short					UL Recognized			570473	
				–	449670				
Long				Stainless steel / – / Stainless steel	–	Yes		570478	
					UL Recognized			449672	
					–			570480	
	UL Recognized	449671							
Short	1 digital input (DI1)	2 relay outputs (DO2, DO3)	PPA	–	–	Yes		570479	
Long					UL Recognized			449673	
					–			570481	
Short					UL Recognized			570479	
				–	449673				
Long				Stainless steel / – / Stainless steel	–	Yes		570481	
					UL Recognized			570479	
					–			449673	
	UL Recognized	570481							

1.) Only if the FKM seal mounted as standard at factory is replaced with the EPDM seal included in the delivery.

DTS 1000011093 EN Version: AI Status: RL (released | freigegeben | validé) printed: 04.04.2025



### Flowmeter with clamp process connection

**Note:**

All these following variants

- have at least
  - a 18...36 V DC operating voltage
  - a 4...20 mA current output (AO1) and
  - a digital output (DO1)
- are supplied with an accessories set (Article no. 565384).













Further information regarding the sets can be found in chapter **"10.5. Ordering chart accessories"** on page 20.

Input	Output	Material			Approval and conformity		Electrical connection	Article no.
		Housing	Sensor / Electrode	Fitting/flowmeter seals <sup>1)</sup>	FDA	ECR1935/2004 <sup>2)</sup>		
–	–	PPA	Stainless steel / Stainless steel	EPDM or FEP	Yes	Yes	2 cable glands M20 × 1.5	564797 
1 digital input (DI1)	2 relay outputs (DO2, DO3)							564798 

1.) Must be ordered separately.

2.) Only for mounting with EPDM seal

### 10.5. Ordering chart accessories

Description	Article no.
<b>For flowmeter with G 2" or clamp process connection</b>	
Set with two cable glands M20 × 1.5, two neoprene flat seals for cable gland or plug, two screw plugs M20 × 1.5 and two multi-way seals 2 × 6 mm	449755 
Set with two adaptors M20 × 1.5 /NPT 1/2", two neoprene flat seals for cable gland or plug and two screw plugs M20 × 1.5	551782 
3-point flow calibration certificate <sup>1)</sup>	550676 
FDA declaration of conformity <sup>2)</sup>	803724 
<b>For flowmeter with G 2" process connection</b>	
Set with a stopper for unused cable gland M20 × 1.5, a multiway seal 2 × 6 mm for cable gland, a green FKM seal for the sensor and a mounting instruction sheet	558102 
Set with a green FKM seal and a black EPDM seal	552111 
Fastening ring (open) for Type S020 Insertion fitting	619205 
PC union nut for Type S020 Insertion fitting	619204 
PPA union nut for Type S020 Insertion fitting	440229 
<b>For flowmeter with clamp process connection</b>	
Set with a stopper for unused cable gland M20 × 1.5 and a multiway seal 2 × 6 mm for cable gland	565384 
1 EPDM fitting/measuring device seal	730837 
1 FEP fitting/measuring device seal	730839 
Clamp collar	731164 

1.) Measuring device combined with a Type S020 Insertion fitting, only for DN ≤ 200

2.) For stainless steel or PVDF sensor with FKM or EPDM seal