





### Inline flowmeter or inline batch controller, with paddle wheel

- Up to PN 16, measurement tube size DN 06 to DN 65
- Display for indication of flow rate and volume with two totalizers or dosing
- Automatic calibration using teach-in
- Inputs (with batch controller) and all outputs can be checked without the need for actual flow
- Total and day counters for batch quantity and number of dosing, volume or mass counter indicator (with batch controller)

Product variants described in the data sheet may differ from the product presentation and description.

#### Can be combined with

|   |   |   |
|---|---|---|
|   | <b>Type 8611</b><br>eCONTROL – Universal controller                                 | ▶ |
|  | <b>Type 8619</b><br>multiCELL – multi-channel/multi-function transmitter/controller | ▶ |
|  | <b>Type 8802</b><br>ELEMENT continuous control valve systems – overview             | ▶ |
|  | <b>Type 8644</b><br>AirLINE SP electropneumatic automation system                   | ▶ |

#### Type description

Device Type 8035 with paddle wheel is specially designed for use in neutral or mildly aggressive, particle-free liquids. The device is available as a flowmeter or batch controller.

The device consists of a compact inline sensor-fitting with paddle wheel (Type S030) and a transmitter with display (Type SE35). Assembly is quick and simple thanks to a mounting/bayonet catch system. Bürkert’s “Inline Quarter-Turn” technology guarantees leak-free operation.

Bürkert’s proprietary sensor fitting system ensures simple installation of the devices into all pipelines from DN 06 to DN 65.

The flowmeter is available as a variant with either a standard signal output or as battery-operated display/totaliser with no output.

DTS 1000011089 EN Version: U Status: RL (released | freigegeben | valide) printed: 27.01.2025

## Table of contents

|   |           |
|---|-----------|
| <b>1. General technical data</b>  | <b>4</b>  |
| 1.1. About the device.....  | 4         |
| 1.2. All variants.....  | 4         |
| 1.3. Flowmeter .....  | 6         |
| 1.4. Batch controller.....  | 7         |
| <b>2. Product variants</b>  | <b>8</b>  |
| 2.1. Flowmeter .....  | 8         |
| 2.2. Batch controller.....  | 9         |
| <b>3. Approvals and conformities</b>  | <b>9</b>  |
| 3.1. General notes .....  | 9         |
| 3.2. Conformity .....   | 9         |
| 3.3. Standards.....   | 9         |
| 3.4. Pressure Equipment Directive (PED) .....                                 | 10        |
| Device used on a pipe.....  | 10        |
| 3.5. North America (USA/Canada) .....   | 10        |
| <b>4. Materials</b>   | <b>10</b> |
| 4.1. Bürkert resistApp.....   | 10        |
| 4.2. Material specifications .....  | 11        |
| Flowmeter .....   | 11        |
| Batch controller.....   | 12        |
| <b>5. Dimensions</b>  | <b>13</b> |
| 5.1. Transmitter Type SE35 .....  | 13        |
| With cable plug (DIN EN 175301-803).....                                      | 13        |
| With M20 × 1.5 cable glands .....   | 13        |
| Battery powered indicator/totalizer.....                                      | 14        |
| 5.2. Transmitter Type SE35 mounted in an Inline sensor-fitting Type S030..... | 14        |
| <b>6. Performance specifications</b>  | <b>15</b> |
| 6.1. Pressure temperature diagram .....                                       | 15        |
| <b>7. Product installation</b>  | <b>15</b> |
| 7.1. Installation notes .....   | 15        |
| Flow measurement.....   | 15        |
| <b>8. Product operation</b>   | <b>16</b> |
| 8.1. Measuring principle .....  | 16        |
| <b>Flowmeter:</b> .....   | <b>16</b> |
| <b>Batch controller:</b> .....  | <b>16</b> |
| 8.2. Functional overview .....  | 17        |
| Display and operating keys.....   | 17        |
| Flowmeter with a standard output signal.....                                  | 18        |
| Flowmeter as battery powered indicator/totalizer.....                         | 18        |
| Batch controller.....   | 19        |
| 8.3. Function modes .....   | 20        |
| Flowmeter with standard output signal.....                                    | 20        |
| Batch controller.....   | 20        |
| <b>9. Product design and assembly</b>   | <b>21</b> |
| 9.1. Product assembly .....   | 21        |

|   |           |
|---|-----------|
| <b>10. Networking and combination with other Bürkert products</b> | <b>21</b> |
| 10.1. Flowmeter with a standard output signal.....                | 21        |
| 10.2. Batch controller.....                                       | 22        |
| <b>11. Ordering information</b>                                   | <b>22</b> |
| 11.1. Bürkert eShop .....   | 22        |
| 11.2. Recommendation regarding product selection.....             | 22        |
| 11.3. Bürkert Produktfilter .....                                 | 22        |
| 11.4. Ordering chart .....  | 23        |
| Flowmeter .....   | 23        |
| Batch controller.....   | 23        |
| 11.5. Ordering chart accessories.....                             | 23        |

DTS 1000011089 EN Version: U Status: RL (released | freigegeben | validé) printed: 27.01.2025

## 1. General technical data

### 1.1. About the device

The Inline device Type 8035 is available as a flowmeter or a batch controller in a compact variant. Furthermore, the flowmeter is available either as a measuring device with a standard output signal or as a battery powered indicator/totalizer without output.

### 1.2. All variants

The following data are valid for both the flowmeter and the batch controller.

#### Product properties

##### Material

Make sure the device materials are compatible with the fluid you are using.

Further information can be found in chapter [“4.1. Bürkert resistApp” on page 10.](#)

Further information on the materials can be found in chapter [“4.2. Material specifications” on page 11.](#)

##### Non-wetted parts

|                  |                 |
|------------------|-----------------|
| Lid              | PC              |
| Front panel film | Polyester       |
| Cover            | PC              |
| Housing          | PC              |
| Screw            | Stainless steel |
| Bayonet system   | PC              |
| Cable gland      | PA              |

##### Wetted parts

|                     |  |
|---------------------|--|
| Sensor armature     | Brass, stainless steel, PVC, PP or PVDF (depending on the Inline sensor-fitting variant Type S030)   |
| Axis and bearing    | Ceramics (Al <sub>2</sub> O <sub>3</sub> )   |
| Paddle wheel        | PVDF   |
| Sensor-fitting body | Brass, stainless steel, PVC, PP or PVDF (depending on the Inline sensor-fitting variant Type S030)   |
| Seal                | FKM or EPDM (depending on the Inline sensor-fitting variant Type S030)   |
| Display             | 15 × 60 mm, 8-digit LCD, alphanumeric, 15 segments, 9 mm high  |
| Compatibility       | Any pipe from DN 06...DN 65 which are fitted with Bürkert Type S030 Inline sensor-fitting.<br>For the selection of the nominal diameter of the Inline sensor-fittings, see <a href="#">data sheet Type S030</a> ►. |
| Pipe diameter       | DN 06...DN 65  |
| Dimensions          | Further information can be found in chapter <a href="#">“5. Dimensions” on page 13.</a>  |
| Measuring principle | Paddle wheel   |
| Measuring range     | <ul style="list-style-type: none"> <li>Flow rate: 0.5...1000 l/min (0.13...265 gpm)</li> <li>Flow velocity: 0.3...10 m/s</li> </ul>  |

#### Performance data

|                       |   |
|-----------------------|---|
| Measurement deviation | <ul style="list-style-type: none"> <li>Teach-in: ± 1 % of the measured value<sup>1)</sup> at teach-in flow rate value</li> <li>Standard K-factor: ± 2.5 % of the measured value<sup>1)</sup></li> </ul> |
| Linearity             | ± 0.5 % of full scale <sup>1)</sup>   |
| Repeatability         | ± 0.4 % of the measured value <sup>1)</sup>   |

#### Electrical data

|                                |   |
|--------------------------------|---|
| Power source (not supplied)    | Limited power source according to UL/EN 62368-1 standards or limited energy circuit according to UL/EN 61010-1 paragraph 9.4  |
| DC reverse polarity protection | Yes   |
| Overvoltage protection         | Yes   |
| Voltage supply cable           | <ul style="list-style-type: none"> <li>Cable with maximum operating temperature greater than 80 °C (176 °F) (90 °C (194 °F) for UL-Recognized variant)</li> <li>Max. 50 m length, shielded</li> </ul> |

### Medium data

|                   |  |
|-------------------|--|
| Fluid temperature | With Inline sensor-fitting Type S030 in: <ul style="list-style-type: none"> <li>• PVC: 0...+ 50 °C (+ 32...+ 122 °F)</li> <li>• PP: 0...+ 80 °C (+ 32...+ 176 °F)</li> <li>• PVDF, stainless steel or brass: - 15...+ 100 °C (+ 5...+ 212 °F)</li> </ul> See <b>data sheet Type S030</b> ▶ for more information. |
|-------------------|--|

|                |  |
|----------------|--|
| Fluid pressure | With Inline sensor-fitting Type S030 in: <ul style="list-style-type: none"> <li>• plastic: max. PN 10</li> <li>• metal: max. PN 16 (PN 40 on request)</li> </ul> See <b>data sheet Type S030</b> ▶ for more information. |
|----------------|--|

|           |              |
|-----------|--------------|
| Viscosity | Max. 300 cSt |
|-----------|--------------|

|                         |         |
|-------------------------|---------|
| Rate of solid particles | Max. 1% |
|-------------------------|---------|

|                       |        |
|-----------------------|--------|
| Maximum particle size | 0.5 mm |
|-----------------------|--------|

### Process/Pipe connection & communication

|                 |  |
|-----------------|--|
| Pipe connection | With Inline sensor-fitting Type S030 in: <ul style="list-style-type: none"> <li>• Plastic: true union with nut and solvent/fusion socket, spigot or external thread</li> <li>• Metal: internal or external thread, weld ends, clamp or flange</li> </ul> See <b>data sheet Type S030</b> ▶ for more information. |
|-----------------|--|

### Approvals and conformities

#### Directives

|                              |   |
|------------------------------|---|
| CE directive                 | Further information on the CE Directive can be found in chapter <b>"3.3. Standards"</b> on page 9.  |
| Pressure equipment directive | Complying with article 4, paragraph 1 of 2014/68/EU directive<br>Further information on the pressure equipment directive can be found in chapter <b>"3.4. Pressure Equipment Directive (PED)"</b> on page 10. |
| North America (USA/Canada)   | UL Recognized for the USA and Canada  |

### Environment and installation

|  |  |
|--|--|
| Relative air humidity  | ≤ 80 %, without condensation   |
| Height above sea level                                       | Max. 2000 m  |
| Operating condition  | Continuous   |
| Equipment mobility   | Fixed  |
| Application range  | Indoor and outdoor<br>Protect the device against electromagnetic interference, ultraviolet rays and, when installed outdoors, against the effects of climatic conditions.  |
| Degree of protection <sup>2)</sup> according to IEC/EN 60529 | IP65 with the following conditions met: <ul style="list-style-type: none"> <li>• device wired</li> <li>• cover and lid screwed tight</li> <li>• female cable plug or glands mounted and tightened</li> <li>• with blind plug on unused cable glands</li> </ul> |
| Installation category  | Category I according to UL/EN 61010-1  |
| Pollution degree   | Degree 2 according to UL/EN 61010-1  |

1.) Under reference conditions i.e. measuring medium = water, ambient and water temperature = + 20 °C (+ 68 °F), observing the minimum the minimum inlet and outlet sections and the appropriate inner diameter of the pipe.

2.) Not evaluated by UL

### 1.3. Flowmeter

#### Note:

If the device is mounted in a humid environment or outside, then the maximum voltage allowed is **35 V DC** instead of 36 V DC.

| Product properties                |  |
|-----------------------------------|--|
| <b>Material</b>                   |  |
| Female cable plug/male fixed plug | <ul style="list-style-type: none"> <li>• Body, contact holder and cable gland in PA</li> <li>• Cable gland seal and flat seal in NBR</li> </ul>  |
| <b>Performance data</b>           |  |
| 4...20 mA output uncertainty      | ± 1% of current range  |
| <b>Electrical data</b>            |  |
| Operating voltage (V+)            | <p>Measuring device with standard output signal</p> <ul style="list-style-type: none"> <li>• 12...36 V DC ± 10%, filtered and regulated<br/>Connection to main supply: permanent, through external SELV (Safety Extra Low Voltage) and LPS (Limited Power Source) power supply</li> <li>• 115/230 V AC, 50/60 Hz<br/>Voltage supply available inside the device:               <ul style="list-style-type: none"> <li>– supplied voltage: 27 V DC regulated</li> <li>– maximum current: 125 mA</li> <li>– integrated protection: 125 mA time delay fuse</li> </ul> </li> </ul> <p>Battery powered indicator/totalizer</p> <ul style="list-style-type: none"> <li>• 4 × 1.5 V DC non-rechargeable alkaline AA batteries, lifetime 4 years at 20 °C (68 °F)</li> </ul>   |
| Current consumption               | <p>12...36 V DC powered measuring device with standard output signal, with sensor and without pulse output consumption</p> <ul style="list-style-type: none"> <li>• With relays: ≤ 70 mA</li> <li>• Without relay: ≤ 25 mA</li> </ul>  |
| Power consumption                 | 115/230 V AC powered measuring device: 3 VA  |
| Output                            | <p>Measuring device with standard output signal</p> <ul style="list-style-type: none"> <li>• Transistor (pulse):               <ul style="list-style-type: none"> <li>– potential free</li> <li>– NPN or PNP (wiring dependant)</li> <li>– function: pulse output, adjustable pulse value</li> <li>– 0...400 Hz</li> <li>– 5...36 V DC, 100 mA, voltage drop at 100 mA: 2.5 V DC</li> <li>– duty cycle (pulse duration/period): 0.5</li> <li>– galvanic insulation and protected against overvoltage, polarity reversals and short circuit</li> </ul> </li> <li>• Relay:               <ul style="list-style-type: none"> <li>– 2 relays, normally open, hysteresis, adjustable thresholds</li> <li>– non UL recognized device: 230 V AC/3 A or 40 V DC/3 A (resistive load)</li> <li>– UL recognized device: 30 V AC/42 V<sub>peak</sub>/3 A or 60 V DC/1 A</li> </ul> </li> <li>• Current:               <ul style="list-style-type: none"> <li>– 4...20 mA (3-wire with relays, 2-wire without relay)</li> <li>– sourcing or sinking (wiring dependant)</li> <li>– max. loop impedance: 900 Ω at 30 V DC, 600 Ω at 24 V DC, 50 Ω at 12 V DC, 800 Ω with a 115/230 V AC voltage supply</li> <li>– response time (10...90 %) for the measured value: 6 s (default)</li> </ul> </li> </ul> <p>Battery powered indicator/totalizer</p> <ul style="list-style-type: none"> <li>• Without output</li> </ul> |

|                      |   |
|----------------------|---|
| Voltage supply cable | Measuring device with standard output signal <ul style="list-style-type: none"> <li>External diameter (cable):             <ul style="list-style-type: none"> <li>5...8 mm (with cable plug)</li> <li>6...12 mm (1 cable per cable gland) or 3...5 mm when using a multi-way seal (2 cables per cable gland)</li> </ul> </li> <li>Cross section of wires:             <ul style="list-style-type: none"> <li>0.25...1.5 mm<sup>2</sup> (with cable plug)</li> <li>0.75 mm<sup>2</sup> (with cable gland)</li> </ul> </li> <li>Cross section of the local ground wire: max. 0.75 mm<sup>2</sup></li> </ul> |
|                      | Battery powered indicator/totalizer <ul style="list-style-type: none"> <li>None</li> </ul>  |

#### Process/Pipe connection & communication

|                       |   |
|-----------------------|---|
| Electrical connection | <ul style="list-style-type: none"> <li>Variant 12...36 V DC: cable plug according to DIN EN 175301-803 or cable glands M20 × 1.5</li> <li>Variant with batteries: None</li> </ul> |
|-----------------------|---|

#### Environment and installation

|                     |  |
|---------------------|--|
| Ambient temperature | Operation and storage: <ul style="list-style-type: none"> <li>variant 12...36 V DC: -10...+60 °C (+5...+140 °F)</li> <li>variant 115/230 V AC: -10...+50 °C (+5...+122 °F)</li> <li>variant with batteries: -10...+55 °C (+5...+131 °F)</li> </ul> |
|---------------------|--|

## 1.4. Batch controller

### Note:

If the device is mounted in a humid environment or outside, then the maximum voltage allowed is **35 V DC** instead of 36 V DC.

#### Electrical data

|                        |   |
|------------------------|---|
| Operating voltage (V+) | <ul style="list-style-type: none"> <li>12...36 V DC, max tolerance: -5 % or +10 % at 12 V DC, ±10 % at 36 V DC, filtered and regulated<br/>Connection to main supply: permanent, through external SELV (Safety Extra Low Voltage) and LPS (Limited Power Source) power supply</li> <li>115/230 V AC, 50/60 Hz<br/>Voltage supply available inside the device:             <ul style="list-style-type: none"> <li>supplied voltage: 27 V DC regulated</li> <li>maximum current: 125 mA</li> <li>integrated protection: 125 mA time delay fuse</li> </ul> </li> </ul> |
| Current consumption    | With sensor, without consumption of digital input and pulse output <ul style="list-style-type: none"> <li>With relays:             <ul style="list-style-type: none"> <li>≤ 100 mA (at 12 V DC)</li> <li>≤ 50 mA (at 36 V DC)</li> <li>≤ 55 mA (115/230 V AC)</li> </ul> </li> <li>Without relay:             <ul style="list-style-type: none"> <li>≤ 70 mA (at 12 V DC)</li> <li>≤ 35 mA (at 36 V DC)</li> <li>≤ 40 mA (115/230 V AC)</li> </ul> </li> </ul>  |
| Power consumption      | 115/230 V AC powered measuring device: 3 VA   |
| Input                  | <ul style="list-style-type: none"> <li>DI (1 to 4)</li> <li>Switching threshold <math>V_{on}</math>: 5...36 V DC</li> <li>Switching threshold <math>V_{off}</math> max.: 2 V DC</li> <li>Min. pulse duration: 100 ms</li> <li>Input impedance: 9.4 kΩ</li> <li>Galvanic insulation, protected against polarity reversals and voltage spike</li> </ul>   |

|                      |  |
|----------------------|--|
| Output               | <ul style="list-style-type: none"> <li>• Transistors (digital outputs DO1 and DO4):                             <ul style="list-style-type: none"> <li>– potential-free</li> <li>– NPN or PNP (wiring dependant)</li> <li>– function: pulse output (by default for DO1), batch state (by default for DO4), configurable and parametrisable</li> <li>– 0...300 Hz</li> <li>– 5...36 V DC, 100 mA max., voltage drop at 100 mA: 2.7 V DC</li> <li>– duty cycle (pulse duration/period): &gt; 0.45</li> <li>– galvanic insulation, protected against overvoltage, polarity reversals and short-circuits</li> </ul> </li> <li>• Relays (digital outputs DO2 and DO3):                             <ul style="list-style-type: none"> <li>– 2 relays, normally open, parametrisable (by default: DO2 always configured to control the valve, parametrized of 100 % of the batch quantity and DO3 configured as alarm)</li> <li>– non UL recognized device: 230 V AC/3 A or 40 V DC/3 A (resistive load)</li> <li>– UL recognized device: 30 V AC/42 V<sub>peak</sub>/3 A or 60 V DC/1 A</li> <li>– max. cutting power of 750 VA (resistive load)</li> </ul> </li> </ul> |
| Voltage supply cable | <ul style="list-style-type: none"> <li>• External diameter (cable):                             <ul style="list-style-type: none"> <li>– 6...12 mm (1 cable per cable gland) or</li> <li>– 4 mm when using a multi-way seal (2 cables per cable gland)</li> </ul> </li> <li>• Cross section of wires: 0.75 mm<sup>2</sup></li> </ul>   |

**Process/Pipe connection & communication**

Electrical connection      Cable glands M20 × 1.5

**Environment and installation**

|                     |   |
|---------------------|---|
| Ambient temperature | Operation and storage: <ul style="list-style-type: none"> <li>• variant 12...36 V DC: -10...+60 °C (+5...+140 °F)</li> <li>• variant 115/230 V AC: -10...+50 °C (+5...+122 °F)</li> </ul> |
|---------------------|---|

## 2. Product variants

### 2.1. Flowmeter

The flowmeter is available in two variants:

- Inline flowmeter with standard output signal (4...20 mA, frequency)
- Inline flowmeter as battery powered indicator/totalizer



**Flowmeter with standard output signal**

The device operates on a 2- or 3-wire system and needs a 12...36 V DC or a 115/230 V AC power supply.

The device is equipped with:

- an analogue output (4...20 mA current output)
- a digital output (pulse output) and
- two totalizers.

Some variants are also fitted with two fully configurable relay outputs.

The device allows:

- through the digital or relay outputs
  - to switch a solenoid valve
  - to activate an alarm
  - to generate a flow rate proportional frequency
- through the analogue output to establish a control loop

DTS 1000011089 EN Version: U Status: RL (released | freigegeben | validé) printed: 27.01.2025





### Flowmeter as battery powered indicator/totalizer

The device has no output and displays the instantaneous value as well as the amount of liquid that has flowed through.

## 2.2. Batch controller



The device needs a voltage supply of 12...36 V DC or 115/230 V AC.

The device is equipped with:

- four digital inputs (DI1 to DI4),
- two transistor outputs (DO1 configured as a pulse output and DO4 configured as state output, by default),
- two relay outputs (DO2 always configured to control the valve and by default parametrised of 100 % of the batch quantity and DO3 configured as alarm output by default),
- two volume or mass totalizers and two totalizers for the number of batches performed.

The second relay output can be used to activate another valve, to initiate alarms or to generate warnings.

When mounted in a pipe in series with one or two valves, the batch controller makes it possible to carry out a dosing of one or several quantities of liquids. The unit controls the opening of the valves and measures the quantity of the fluid which flows. The unit also closes the valves when the pre-set quantity has been delivered.

## 3. Approvals and conformities

### 3.1. General notes

- The approvals and conformities listed below must be stated when making enquiries. This is the only way to ensure that the product complies with all required specifications.
- Not all available variants of the device can be supplied with the below mentioned approvals or conformities.

### 3.2. Conformity

In accordance with the Declaration of Conformity, the product is compliant with the EU Directives.

### 3.3. Standards

The applied standards which are used to demonstrate compliance with the EU Directives are listed in the EU-Type Examination Certificate and/or the EU Declaration of Conformity.

### 3.4. Pressure Equipment Directive (PED)

The device conforms to article 4, paragraph 1 of the Pressure Equipment Directive (PED) 2014/68/EU under the following conditions:

#### Device used on a pipe

**Note:**

- The data in the table is independent of the chemical compatibility of the material and the fluid.
- PS = maximum admissible pressure (in bar), DN = nominal diameter of the pipe

| Type of fluid                              | Conditions                          |
|--|-------------------------------------|
| Fluid group 1, Article 4, Paragraph 1.c.i  | DN ≤ 25                             |
| Fluid group 2, Article 4, Paragraph 1.c.i  | DN ≤ 32 or PS*DN ≤ 1000             |
| Fluid group 1, Article 4, Paragraph 1.c.ii | DN ≤ 25 or PS*DN ≤ 2000             |
| Fluid group 2, Article 4, Paragraph 1.c.ii | DN ≤ 200 or PS ≤ 10 or PS*DN ≤ 5000 |

### 3.5. North America (USA/Canada)

| Approval | Description  |
|----------|--|
|          | <p><b>Optional: UL Recognized for the USA and Canada</b><br/>                     The products are UL Recognized for the USA and Canada according to:</p> <ul style="list-style-type: none"> <li>• UL 61010-1 (ELECTRICAL EQUIPMENT FOR MEASUREMENT, CONTROL, AND LABORATORY USE – Part 1: General Requirements)</li> <li>• CAN/CSA-C22.2 No. 61010-1</li> </ul> |

## 4. Materials

### 4.1. Bürkert resistApp

**Bürkert resistApp – Chemical resistance chart**

You want to ensure the reliability and durability of the materials in your individual application case? Verify your combination of media and materials on our website or in our resistApp.

[Start chemical resistance check](#)

DTS 1000011089 EN Version: U Status: RL (released | freigegeben | valide) printed: 27.01.2025

## 4.2. Material specifications

### Flowmeter

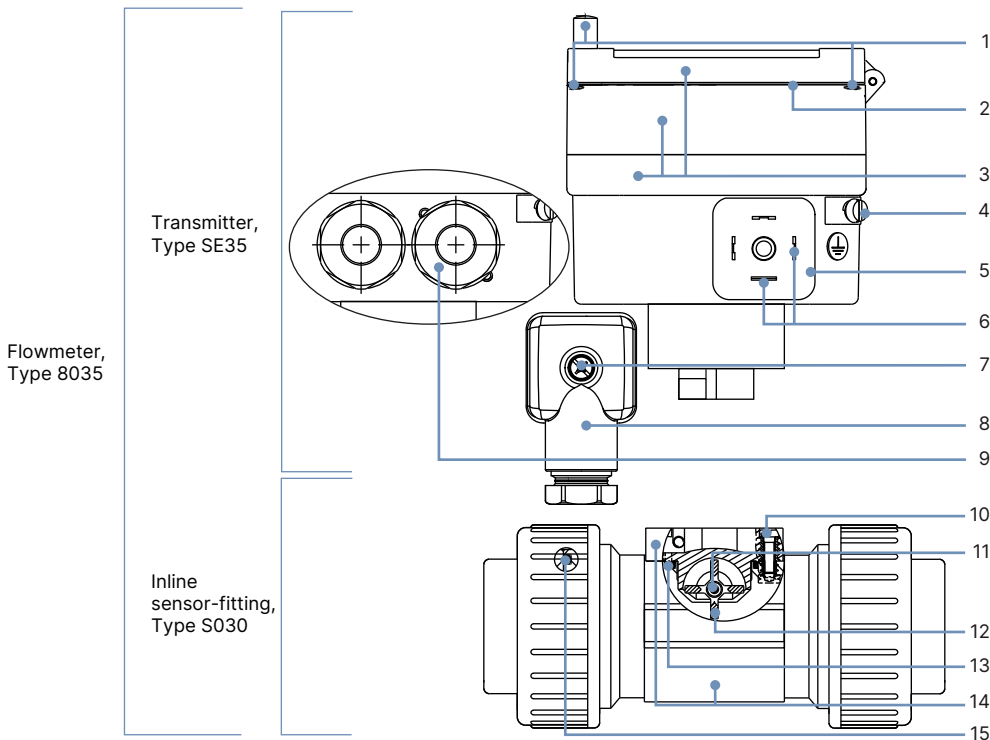

| No. | Element                               | Material   |
|-----|---------------------------------------|--|
| 1   | Screws                                | Stainless steel  |
| 2   | Front panel folio                     | Polyester  |
| 3   | Housing, cover, lid                   | PC   |
| 4   | Screws                                | Stainless steel  |
| 5   | Male fixed plug (DIN EN 175301-803)   | PA   |
| 6   | Electrical contact                    | Sn   |
| 7   | Screw                                 | Stainless steel  |
| 8   | Female cable plug (DIN EN 175301-803) | <ul style="list-style-type: none"> <li>Body, contact holder and cable gland in PA</li> <li>Cable gland seal and flat seal in NBR</li> </ul>            |
| 9   | M20 x 1.5 cable gland                 | PA   |
| 10  | Screws                                | Stainless steel  |
| 11  | Axis and bearings                     | Ceramics (Al <sub>2</sub> O <sub>3</sub> )   |
| 12  | Paddle wheel                          | PVDF   |
| 13  | Seal                                  | FKM or EPDM (depending on the Inline sensor-fitting variant Type S030)   |
| 14  | Sensor-fitting body, sensor armature  | Stainless steel (316L - 1.4404), brass (CuZn <sub>39</sub> Pb <sub>2</sub> ), PVC, PP, PVDF (depending on the Inline sensor-fitting variant Type S030) |
| 15  | Seals                                 | FKM or EPDM (depending on the Inline sensor-fitting variant Type S030 and only for true union connection with nut and solvent/fusion socket)           |

DTS 1000011089 EN Version: U Status: RL (released | freigegeben | valide) printed: 27.01.2025

**Batch controller**

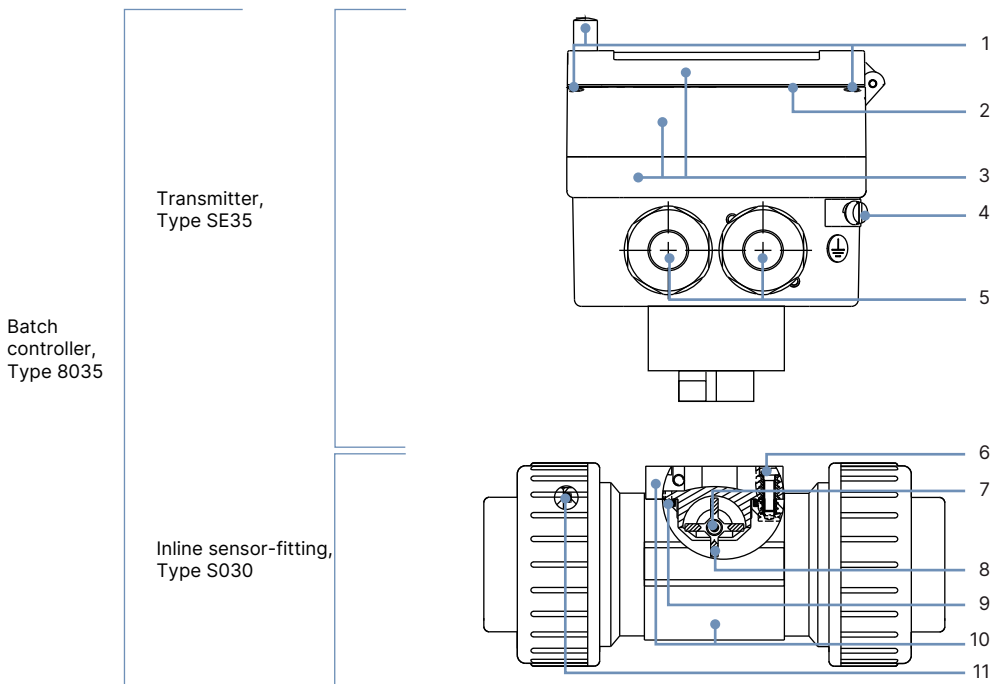

| No. | Element                              | Material   |
|-----|--------------------------------------|--|
| 1   | Screws                               | Stainless steel  |
| 2   | Front panel folio                    | Polyester  |
| 3   | Housing, cover, lid                  | PC   |
| 4   | Screws                               | Stainless steel  |
| 5   | M20 × 1.5 cable gland                | PA   |
| 6   | Screws                               | Stainless steel  |
| 7   | Axis and bearings                    | Ceramics (Al <sub>2</sub> O <sub>3</sub> )   |
| 8   | Paddle wheel                         | PVDF   |
| 9   | Seal                                 | FKM or EPDM (depending on the Inline sensor-fitting variant Type S030)   |
| 10  | Sensor-fitting body, sensor armature | Stainless steel (316L - 1.4404), brass (CuZn <sub>39</sub> Pb <sub>2</sub> ), PVC, PP, PVDF (depending on the Inline sensor-fitting variant Type S030) |
| 11  | Seals                                | FKM or EPDM (depending on the Inline sensor-fitting variant Type S030 and only for true union connection with nut and solvent/fusion socket)           |

DTS 1000011089 EN Version: U Status: RL (released | freigegeben | validé) printed: 27.01.2025

## 5. Dimensions

### 5.1. Transmitter Type SE35

With cable plug (DIN EN 175301-803)

**Note:**

- Dimensions in mm, unless otherwise stated
- Flowmeter with standard output signal

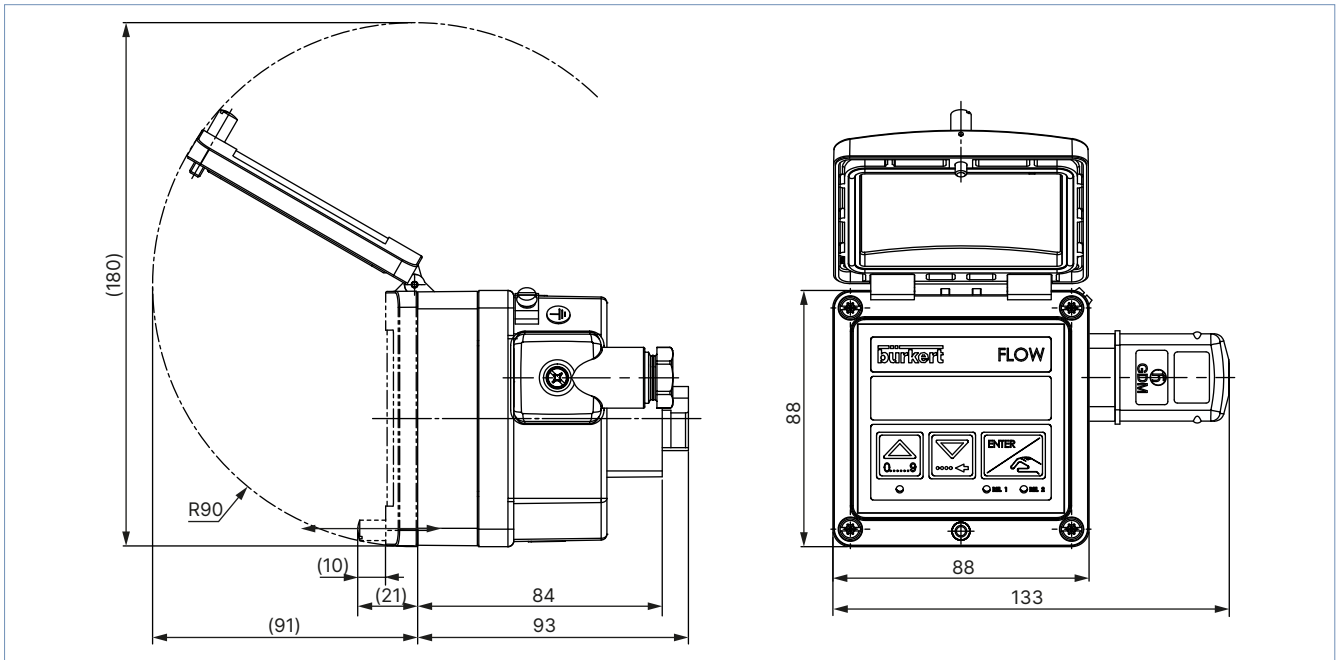

With M20 × 1.5 cable glands

**Note:**

- Dimensions in mm, unless otherwise stated
- Flowmeter with standard output signal or batch controller

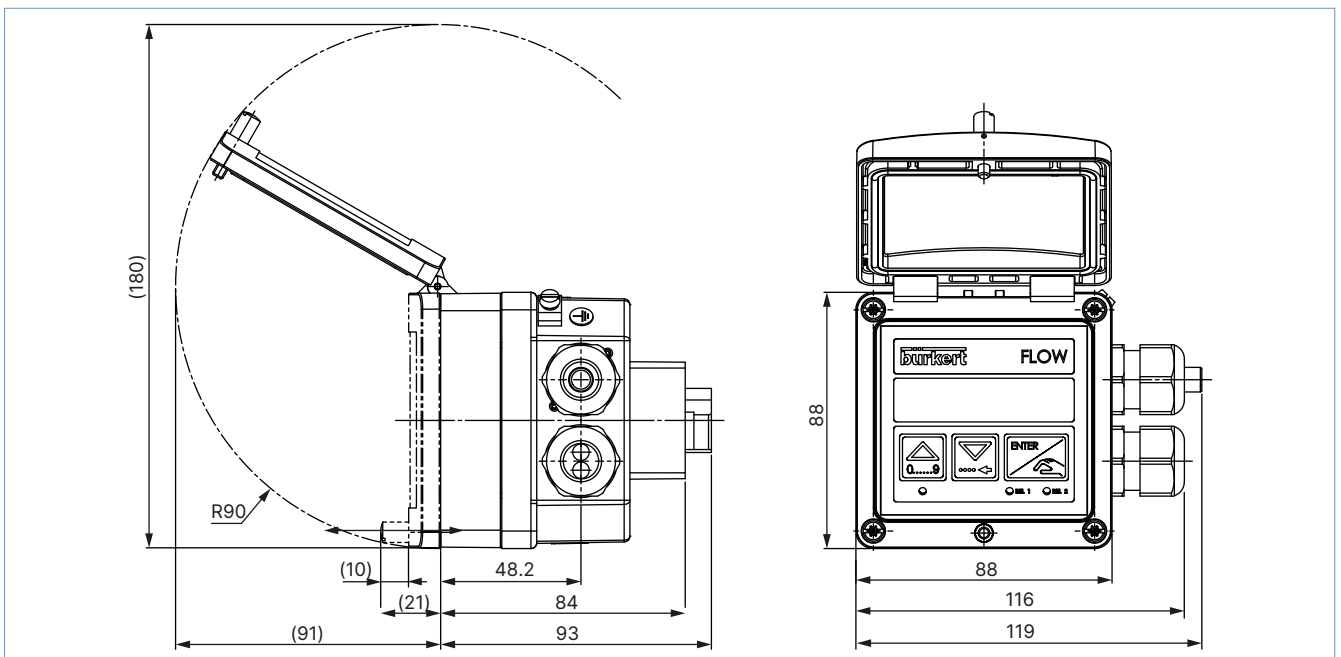

**Battery powered indicator/totalizer**

**Note:**

Dimensions in mm, unless otherwise stated

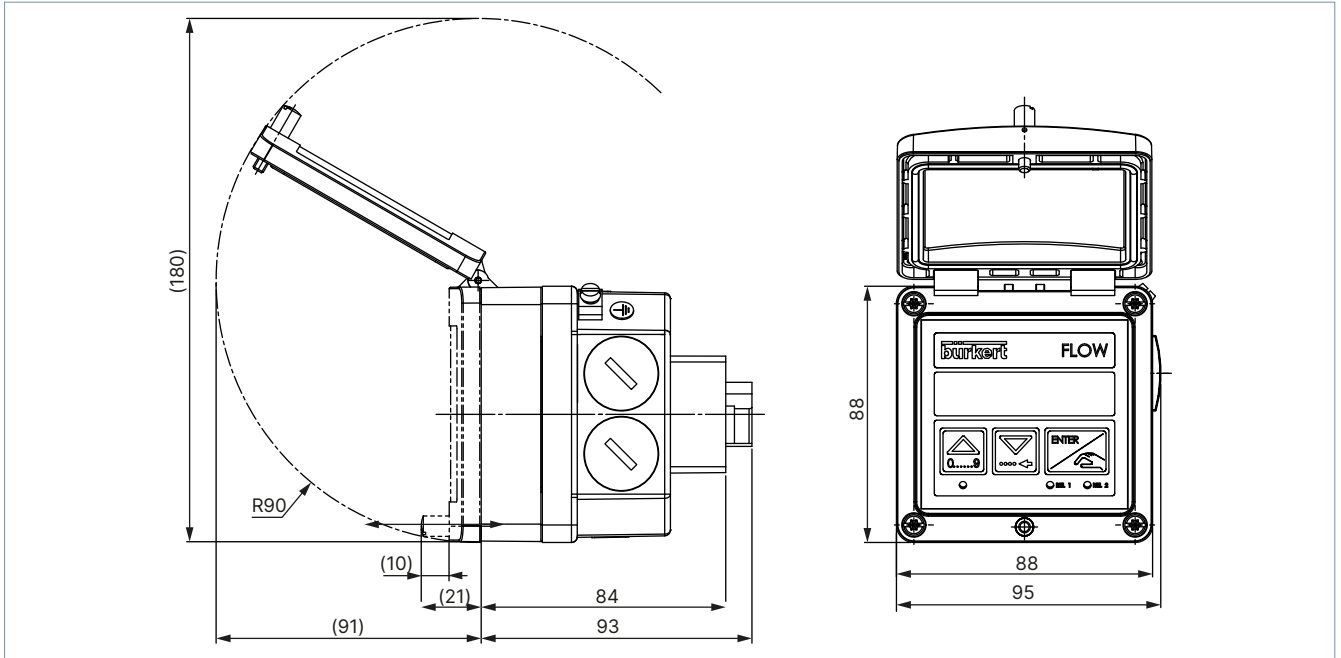

**5.2. Transmitter Type SE35 mounted in an Inline sensor-fitting Type S030**

**Note:**

Dimensions in mm, unless otherwise stated

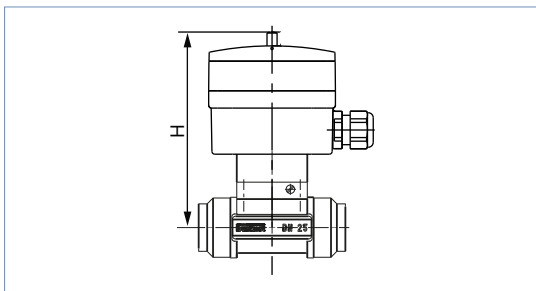

| DN | H   |
|----|-----|
| 06 | 134 |
| 08 | 134 |
| 15 | 139 |
| 20 | 137 |
| 25 | 137 |
| 32 | 140 |
| 40 | 144 |
| 50 | 151 |
| 65 | 151 |

## 6. Performance specifications

### 6.1. Pressure temperature diagram

**Note:**

The following diagram applies to the flowmeter or batch controller.

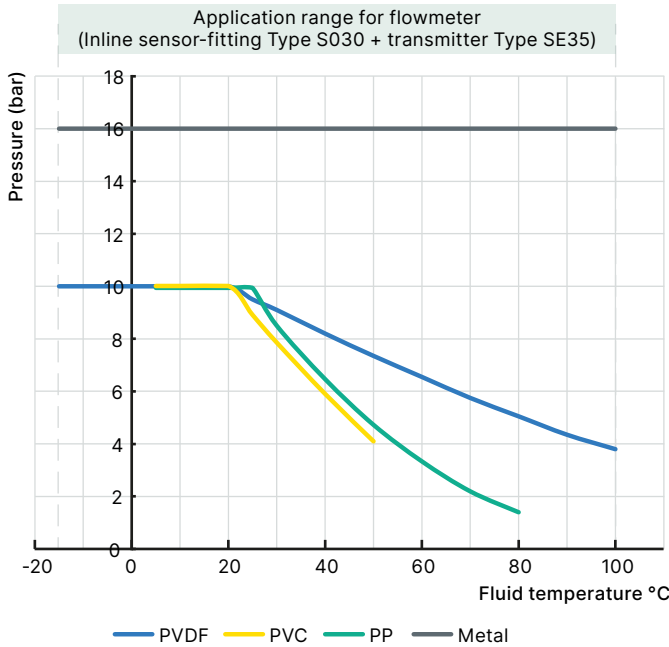

DTS 1000011089 EN Version: U Status: RL (released | freigegeben | validé) printed: 27.01.2025

## 7. Product installation

### 7.1. Installation notes

**Flow measurement**

**Note:**

The device is not suitable for use in gaseous media and steam.

Minimum straight distances upstream and downstream of the sensor must be observed. These stabilizing distances depend on the pipe's design. Increasing these distances or installing a flow conditioner may be necessary to obtain the best accuracy. For more information, refer to EN ISO 5167-1.

EN ISO 5167-1 specifies the straight inlet and outlet distances that must be complied with when installing fittings in pipe lines in order to achieve calm flow conditions. The most commonly used elements that could lead to turbulence in the flow are shown below. The related minimum inlet and outlet distances that ensure a calm flow are also specified.

Make sure that the measuring conditions at the point of measurement are calm and problem-free.

**DN = Orifice**

**Fluid direction →**

Regulating valve<sup>1)</sup>

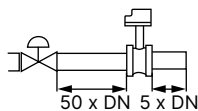

2 x 90° elbow joint

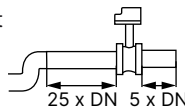

Expansion<sup>2)</sup>

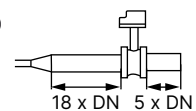

2 x 90° elbow joint  
3 dimensional

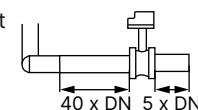

90° elbow joint  
or T-piece

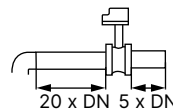

Reduction

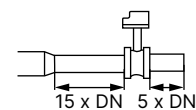

1.) If the valve cannot be mounted after the measuring device, the minimal distances have to be respected.

2.) If an expansion cannot be avoided, the minimal distances have to be respected.

Please note minimum flow velocity

The device can be installed in either horizontal or vertical pipes, but following additional conditions should be respected:

- The pipe always has to be filled with fluid at all times near the device.
- The pipe design must be such that no air bubbles or cavitation can form within the medium near the device at any time.

The flowmeter can be installed into either horizontal or vertical pipes.

Important criteria for this are; ensure that the measurement pipe is fully filled and that the measurement pipe is air bubble free.

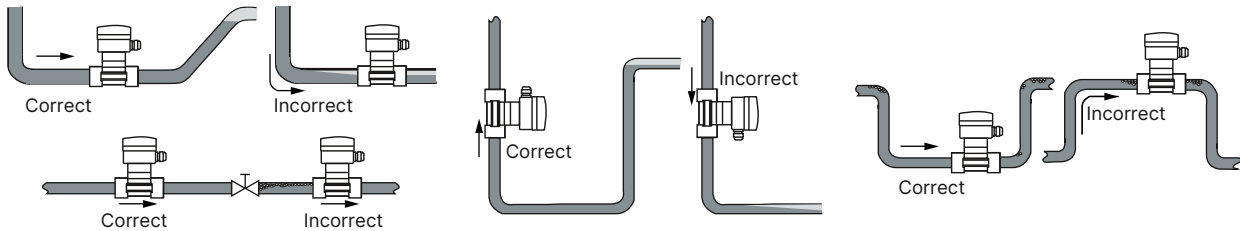

Pressure and temperature ratings must be respected according to the selected fitting material. The suitable pipe size is selected using the diagram in the chapter "Nominal size selection" of the **data sheet Type S030** ▶.

## 8. Product operation

### 8.1. Measuring principle

When liquid flows through the pipe, the paddle wheel with 4 inserted magnets is set in rotation, producing a measuring signal in the sensor (coil or Hall sensor depending on variant). The frequency modulated induced voltage is proportional to the flow velocity of the fluid.

A K factor, specific to each pipe, enables the conversion of this frequency into a flow rate/volume.

This K factor is available in the fittings' operating instructions, see **Type S030** ▶.

#### Flowmeter:

The electronic component converts the measured signal into several outputs (according to the device variant) and displays the actual value. Totalizers are used to obtain the volume of fluid passed through the pipe.

The electrical connection for the flowmeter with standard output signal is provided via a cable plug according to DIN EN 175301-803 or two cable glands (according to the flowmeter variant).

#### Batch controller:

The electronic component converts the measured signal and displays the actual value of the volume or mass. The electrical connection is provided via two cable glands.



## 8.2. Functional overview

### Display and operating keys

The display is used to:

- read the value of certain parameters e.g. for the flowmeter, the measured flow rate, the main totalizer
- set parameters of the device by means of 3 keys
- read the configuration of the device
- be warned of certain events.

| Display and operating keys | No. | Description   |
|----------------------------|-----|---|
|                            | 1   | "Back" key: <ul style="list-style-type: none"> <li>• to change the value (0...9) of the selected digit</li> <li>• to go back to the previous function</li> <li>• Read the batches history (only for batch controller)</li> </ul>  |
|                            | 2   | "Next" key: <ul style="list-style-type: none"> <li>• to select the digit at the left</li> <li>• to go to the next function</li> <li>• read messages (only with Inline flowmeter as battery powered indicator/totalizer and with batch controller)</li> </ul>  |
|                            | 3   | "Confirm" key: <ul style="list-style-type: none"> <li>• to confirm the function displayed</li> <li>• to confirm the parameters set</li> </ul>   |
|                            | 4   | <ul style="list-style-type: none"> <li>• For Inline flowmeter with a standard output signal                             <ul style="list-style-type: none"> <li>- status LED of relay 2</li> </ul> </li> <li>• For batch controller                             <ul style="list-style-type: none"> <li>- status LED of relay DO3 (LED ON = contact closed)</li> </ul> </li> </ul>  |
|                            | 5   | <ul style="list-style-type: none"> <li>• For Inline flowmeter with a standard output signal                             <ul style="list-style-type: none"> <li>- status LED of relay 1</li> </ul> </li> <li>• For batch controller                             <ul style="list-style-type: none"> <li>- status LED of relay DO2 (LED ON = contact closed)</li> </ul> </li> </ul>  |
|                            | 6   | Status of device <ul style="list-style-type: none"> <li>• No status for Inline flowmeter with a standard output signal</li> <li>• For Inline flowmeter as a battery powered indicator/totalizer                             <ul style="list-style-type: none"> <li>- off: the device operates correctly.</li> <li>- blinking orange: a warning message is generated in the information menu.</li> <li>- blinking red: a fault message is generated</li> </ul> </li> <li>• For batch controller                             <ul style="list-style-type: none"> <li>- green: the device operates correctly.</li> <li>- orange: a dosing related alarm and/or a warning messages is generated in the information menu.</li> <li>- red: a fault message is generated in the information menu..</li> <li>- blinking, whatever the colour:                                     <ul style="list-style-type: none"> <li>- slow blinking: the dosing is interrupted.</li> <li>- Fast blinking during a dosing: a dosing related alarm is generated.</li> <li>- Fast blinking when no dosing is being done: the information menu has been remote-consulted or a check for the correct behaviour of the inputs/outputs is running</li> </ul> </li> </ul> </li> </ul> |

The device can be calibrated by means of the K factor of the fitting or via the teach-in function. User adjustments, such as engineering units, output, filter or bargraph are carried out on site.

DTS 1000011089 EN Version: U Status: RL (released | freigegeben | validé) printed: 27.01.2025

**Flowmeter with a standard output signal**

The device has 2 operating levels:

- the process level
- the configuration level, which comprises the parameters and the test menus

| Operating level                 | Functions  |
|---------------------------------|--|
| Process                         | <ul style="list-style-type: none"> <li>• Indication of                             <ul style="list-style-type: none"> <li>– the value of the measured flow</li> <li>– the value of the 4...20 mA output</li> <li>– the value of the main totalizer</li> <li>– the value of the daily totalizer</li> </ul> </li> <li>• Reset the daily totalizer</li> <li>• Access to the Parameters and Test menus of the Configuration level</li> </ul>                       |
| Configuration - parameters menu | <ul style="list-style-type: none"> <li>• To make the settings needed for operation:                             <ul style="list-style-type: none"> <li>– language</li> <li>– engineering units (International measuring units)</li> <li>– K-factor/Teach-in function</li> <li>– 4...20-mA-current output</li> <li>– pulse output</li> <li>– relay (on devices with relays)</li> <li>– filter (damping)</li> <li>– reset both totalizers</li> </ul> </li> </ul> |
| Configuration - test menu       | <ul style="list-style-type: none"> <li>• To adjust the Offset and Span of the 4...20 mA current output</li> <li>• To read the rotational frequency of the paddle wheel</li> <li>• To check the correct operating of the outputs with simulating a flow rate</li> </ul>   |

**Flowmeter as battery powered indicator/totalizer**

The device has 2 operating levels:

- the process level
- the configuration level, which comprises the parameters, the test and the information menus

| Operating level                  | Functions  |
|----------------------------------|--|
| Process                          | <ul style="list-style-type: none"> <li>• Indication of                             <ul style="list-style-type: none"> <li>– the value of the measured flow</li> <li>– the value of the main totalizer</li> <li>– the value of the daily totalizer</li> </ul> </li> <li>• Reset the daily totalizer</li> <li>• Access to the Parameters, Test and Information menus of the Configuration level</li> </ul> |
| Configuration - parameters menu  | <ul style="list-style-type: none"> <li>• To make the settings needed for operation:                             <ul style="list-style-type: none"> <li>– language</li> <li>– engineering units (International measuring units)</li> <li>– K-factor/Teach-in function</li> <li>– filter (damping)</li> <li>– reset both totalizers</li> </ul> </li> </ul>   |
| Configuration - test menu        | <ul style="list-style-type: none"> <li>• To read the rotational frequency of the paddle wheel</li> <li>• To generate warning and error messages</li> </ul>   |
| Configuration - information menu | <ul style="list-style-type: none"> <li>• To read                             <ul style="list-style-type: none"> <li>– the charge of the batteries</li> <li>– the error or warning messages generated by the device</li> </ul> </li> </ul>  |

DTS 1000011089 EN Version: U Status: RL (released | freigegeben | validé) printed: 27.01.2025

**Batch controller**

The device has 2 operating levels:

- The process level
- The configuration level, which includes the parameters, the test, the information and the history menus

| Operating level                  | Functions   |
|----------------------------------|---|
| Process                          | <ul style="list-style-type: none"> <li>• Starting a dosing</li> <li>• Indication of                             <ul style="list-style-type: none"> <li>– The value of the main totalizers of the quantity of fluid counted</li> <li>– The value of the daily totalizers of the quantity of fluid counted</li> <li>– The value of the main totalizers of the performed dosings</li> <li>– The value of the daily totalizers of the performed dosings</li> </ul> </li> <li>• Reset                             <ul style="list-style-type: none"> <li>– The daily volume or mass totalizer</li> <li>– The daily totalizer of the performed dosings</li> </ul> </li> <li>• Access to the parameters, test, information and history menus of the configuration level</li> </ul> |
| Configuration - parameters menu  | <ul style="list-style-type: none"> <li>• To make the settings needed for operation:                             <ul style="list-style-type: none"> <li>– language</li> <li>– engineering units (International measuring units)</li> <li>– K-factor/Teach-in function</li> <li>– Optional/dosing mode</li> <li>– Overfill</li> <li>– Alarm</li> <li>– Outputs</li> <li>– Resetting the 2 volume or mass totalizers</li> <li>– Resetting the 2 totalizers of the performed dosings</li> <li>– Resetting the history menu</li> <li>– Backlight</li> </ul> </li> </ul>  |
| Configuration - test menu        | <ul style="list-style-type: none"> <li>• Checking:                             <ul style="list-style-type: none"> <li>– The inputs functions</li> <li>– The outputs functions</li> <li>– The paddle-wheel operation</li> </ul> </li> <li>• Monitoring:                             <ul style="list-style-type: none"> <li>– The flow rate in the pipe</li> <li>– The value of the daily volume or mass totalizer</li> <li>– The number of performed dosings</li> </ul> </li> <li>• Saving/ Restoring:                             <ul style="list-style-type: none"> <li>– The current user configuration</li> <li>– The saved configuration</li> <li>– The default configuration of the device</li> </ul> </li> </ul>  |
| Configuration - history menu     | To consult the quantities dosed in the last 10 dosings performed  |
| Configuration - information menu | To read the fault and warning messages generated  |

DTS 1000011089 EN Version: U Status: RL (released | freigegeben | validé) printed: 27.01.2025

### 8.3. Function modes

#### Flowmeter with standard output signal

- 4...20 mA output + Pulse
- 4...20 mA output + Pulse + relay output  
Hysteresis switching mode (both relays) for the output, inverted or not

#### Hysteresis mode

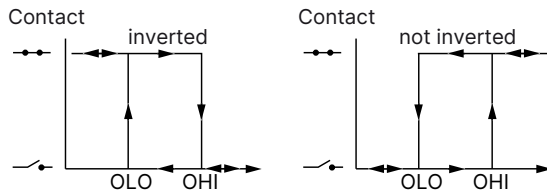

#### Batch controller

The following dosing modes are possible:

- **Locally started dosing of**
  - **free quantity:** the user enters the quantity to be filled and starts the dosing from the keypad.
  - **pre-set quantity:** the user selects a quantity which has been pre-set and starts the dosing from the keypad.
- **Dosing controlled by a PLC unit:** the user selects a quantity which has been pre-set and starts the dosing using binary inputs.
- **Locally/remote selection of pre-set quantity and dosing controlled by a PLC unit:** the user selects a quantity which has been pre-set from the keypad or using binary inputs and starts the dosing using binary inputs.
- **Automatic dosing controlled by variation of pulse duration:** the volume to be dosed is directly proportional to the duration of a pulse.
- **Locally/remote dosing determined by teach-in:**
  - teach-in of the dosing quantity from the keypads
  - teach-in of the dosing quantity using binary inputs.

## 9. Product design and assembly

### 9.1. Product assembly

**Note:**

- The device Type 8035 is made up of a Bürkert Inline sensor-fitting Type S030 equipped with a paddle wheel sensor and a transmitter Type SE35.
- The electronic housing of the Type 8035 integrates the electronic board with display, setting parameter keys as well as a transducer (coil for battery indicator/totalizer variant or Hall for the other variants).
- The Inline sensor-fitting Type S030 ensures simple installation into pipes from DN 06...DN 65. The transmitter Type SE35 can be mounted on any Inline sensor-fitting Type S030 and fastened with a bayonet catch, see **data sheet Type S030** ▶ for more information.

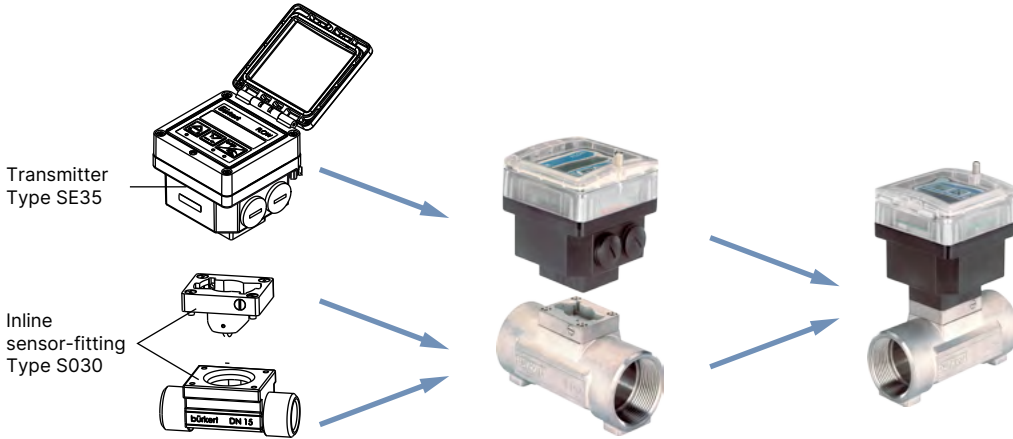

## 10. Networking and combination with other Bürkert products

### 10.1. Flowmeter with a standard output signal

**Example:**



| 4...20 mA output   | Pulse output   | Relay output   |
|--|--|--|
|  |  |  |
| <b>Type 8802 ▶</b><br><b>(2301 &amp; 8693)</b><br>ELEMENT Continuous control valve systems | <b>Type 6212 ▶</b><br>Servo-assisted 2/2-way diaphragm valve | <b>Type 6281 ▶</b><br>Servo-assisted 2/2-way diaphragm valve |

DTS 1000011089 EN Version: U Status: RL (released | freigegeben | validé) printed: 27.01.2025

## 10.2. Batch controller

Example:



## 11. Ordering information

### 11.1. Bürkert eShop



**Bürkert eShop – Bequem bestellt und schnell geliefert**

Sie möchten Ihr gewünschtes Bürkert-Produkt oder -Ersatzteil schnell finden und direkt bestellen? Unser Onlineshop ist rund um die Uhr für Sie erreichbar. Melden Sie sich gleich an und nutzen Sie die Vorteile.

[Jetzt online einkaufen](#)

### 11.2. Recommendation regarding product selection

A complete Type 8035 Inline flowmeter or batch controller consists of a compact Type SE35 flow transmitter and a Bürkert Inline sensor-fitting Type S030.

See **data sheet Type S030 ▶** for more information.

Two different components must be ordered in order to select a complete device. The following information is required:

- **Article no.** of the desired compact Type SE35 flow transmitter (see chapter **"11.4. Ordering chart" on page 23**)
- **Article no.** of the selected Type S030 Inline sensor-fitting (see **data sheet Type S030 ▶**)

### 11.3. Bürkert Produktfilter



**Bürkert Produktfilter – Schnell zum passenden Produkt**

Sie möchten anhand Ihrer technischen Anforderungen einfach und bequem selektieren? Nutzen Sie den Bürkert Produktfilter und finden Sie unseren passenden Artikel für Ihre Anwendung.









[Jetzt Produkte filtern](#)

## 11.4. Ordering chart

### Flowmeter

#### Note:



The following variants have at least 2 volume totalizers.

| Operating voltage   | Sensor variant | Output                                 | UL approval   | Electrical connection                  | Article no.  |
|---|----------------|--|---------------|--|--|
| <b>Flow transmitter Type SE35 with standard output signal</b> |                |  |               |  |  |
| 12...36 V DC  | Hall           | 4...20 mA (2 wires) + Pulse            | —             | Female cable plug<br>DIN EN 175301-803 | 444005  |
|   |                |  | UL Recognized |  | 570477  |
|   |                |  | —             | 2 cable glands                         | 444006  |
|   |                |  | UL Recognized |  | 553432  |
|   | Hall           | 4...20 mA (3 wires) + Pulse + 2 relays | —             | 2 cable glands                         | 444007  |
|   |                |  | UL Recognized | 2 cable glands                         | 553433  |
| 115/230 V AC  | Hall           | 4...20 mA (2 wires) + Pulse            | —             | 2 cable glands                         | 423922  |
|   | Hall           | 4...20 mA (3 wires) + Pulse + 2 relays | —             | 2 cable glands                         | 423924  |
| <b>Flow transmitter Type SE35 as indicator</b>                |                |  |               |  |  |
| 4 × 1.5 V DC<br>AA batteries                                  | Coil           | Keine                                  | —             | None                                   | 423921  |







### Batch controller

#### Note:

The following variants have at least 2 volume or mass totalizers and 2 totalizers of the number of dosing performed.

| Operating voltage | Sensor variant | Input                           | Output   | UL approval  | Electrical connection | Article no.  |
|-------------------|----------------|---------------------------------|--|--|-----------------------|--|
| 12...36 V DC      | Hall           | 4 digital inputs<br>(DI1...DI4) | 2 transistor outputs (DO1<br>and DO4) + 2 relay<br>outputs (DO2 and DO3) | —  | 2 cable glands        | 443360  |
|                   |                |                                 |  | UL Recognized  |                       | 564398  |
| —                 |                |                                 |  | 423926  |                       |  |
| 115/230 V AC      |                |                                 |  |  |                       |  |

## 11.5. Ordering chart accessories

| Description  | Article no.  |
|--|--|
| <b>For flowmeter or batch controller</b>   |  |
| Set with two cable glands M20 × 1.5, two neoprene flat seals for cable gland or plug, two screw plugs M20 × 1.5 and two multi-way seals 2 × 6 mm                             | 449755  |
| Set with two adaptors M20 × 1.5 /NPT ½", two neoprene flat seals for cable gland or plug and two screw plugs M20 × 1.5   | 551782  |
| Set with a stopper for unused cable gland M20 × 1.5, a multi-way seal 2 × 6 mm for cable gland, a black EPDM seal for the sensor and a mounting instruction sheet            | 551775  |
| <b>For flowmeter</b>   |  |
| Female cable plug, 4-pin (3 conductors + protective conductor), form A according to DIN EN 175301-803 with cable gland ( <b>Type 2518</b> ▶)                                 | 572264  |
| Female cable plug 32 mm, 4-pin (3 conductors + protective conductor), form A according to DIN EN 175301-803, with NPT ½" reduction without cable gland ( <b>Type 2509</b> ▶) | 162673  |
| <b>For batch controller</b>  |  |
| Set with 8 FLOW front panel films  | 553191  |