

### Paddle wheel sensor for low-flow rates

- Cost attractive solution for low-flow rates and solid-free liquids
- Wetted parts made of ECTFE, sapphire, coated stainless steel, FKM or EPDM for use in aggressive liquids
- 3-wire system with paddle wheel and Hall sensor up to 80 °C, 10 bar
- Frequency output proportional to the flow rate, PLC-compatible

Product variants described in the data sheet may differ from the product presentation and description.

#### Can be combined with

- 

**Type 8025** ▶

Insertion flowmeter or batch controller with paddle wheel and flow transmitter or remote batch controller
- 

**Type 8611** ▶

eCONTROL – Universal controller
- 

**Type 8619** ▶

multiCELL – multi-channel/multi-function transmitter/controller
- 

**Type 8802** ▶

ELEMENT continuous control valve systems – overview

#### Type description

The compact low-flow sensor Type 8031 with paddle wheel and Hall sensor is specially designed for use in aggressive and solid-free liquids.

The particular cost attractive measuring principle is based on a local flow velocity measurement. The sensor produces a flow proportional frequency signal which can easily be transmitted and processed.

We recommend here particularly the connection to the Bürkert Universal transmitter Type 8025 (see separate data sheet).

## Table of contents

<b>1. General technical data</b>	<b>3</b>
<hr/>	
<b>2. Approvals and conformities</b>	<b>4</b>
2.1. Conformity .....	4
2.2. Standards .....	4
2.3. Pressure Equipment Directive (PED) .....	4
Device used on a pipe.....	4
<hr/>	
<b>3. Materials</b>	<b>4</b>
3.1. Bürkert resistApp .....	4
<hr/>	
<b>4. Dimensions</b>	<b>5</b>
4.1. Paddle wheel sensor with G ¼" pipe connection .....	5
4.2. Paddle wheel sensor with 8/6 mm tube spigot pipe connection.....	5
4.3. Paddle wheel sensor with 9 mm tube spigot pipe connection .....	6
<hr/>	
<b>5. Performance specifications</b>	<b>6</b>
5.1. Pressure loss diagram.....	6
5.2. Flow characteristic .....	7
Determination of the K-factor.....	7
<hr/>	
<b>6. Ordering information</b>	<b>7</b>
6.1. Bürkert eShop .....	7
6.2. Bürkert product filter .....	7
6.3. Ordering chart .....	8

DTS 1000011083 EN Version: T Status: RL (released | freigegeben | validé) printed: 24.01.2025

## 1. General technical data

### Product properties

#### Material

Make sure the device materials are compatible with the fluid you are using.  
 Further information can be found in chapter [“3.1. Bürkert resistApp” on page 4.](#)

#### Wetted parts

Axis	Coated stainless steel or sapphire
Bearing	POM or Rubin
Paddle wheel	POM or ECTFE
Magnet	ECTFE encapsuled or blank
Sensor housing	POM or ECTFE
Seal	FKM, EPDM or FFKM

Dimensions Further information can be found in chapter [“4. Dimensions” on page 5.](#)

Measuring principle Paddle wheel

Measuring range

- 10...100 l/h (2.6...27 gph)
- 20...250 l/h (5.3...66 gph)

Standard K factor

- 10200 pulse/litre (range 10...100 l/h)
- 3400 pulse/litre (range 20...250 l/h)

Further information can be found in chapter [“5.2. Flow characteristic” on page 7.](#)

### Performance data

Measurement deviation  $\pm 2\%$  of full scale

Repeatability  $\pm 0.8\%$  of full scale

Pressure loss Further information can be found in chapter [“5.1. Pressure loss diagram” on page 6.](#)

### Electrical data

Operating voltage 5...24 V DC

Current consumption Max. 11 mA at 24 V DC

Output

- Push-pull (complementary output) between V+ (white wire) and signal (green wire) or between GND (brown wire) and signal (green wire)
- Frequency: 0...300 Hz

### Medium data

Fluid temperature 0...80 °C (+ 32...+ 176 °F)

Fluid pressure Max. 10 bar (145 PSI) at 20 °C (68 °F)

Viscosity 1...10 cSt.

### Process/Pipe connection & communication

Pipe connection

- G ¼"
- Tube spigot 8/6 mm
- Tube spigot 9 mm

Electrical connection Cable, 1 m length (3 × 0.14 LiYY)

### Approvals and conformities

#### Directives

CE directive Further information on the CE Directive can be found in chapter [“2.2. Standards” on page 4.](#)

Pressure equipment directive Complying with article 4, paragraph 1 of 2014/68/EU directive  
 Further information on the pressure equipment directive can be found in chapter [“2.3. Pressure Equipment Directive \(PED\)” on page 4.](#)

### Environment and installation

Ambient temperature

- Operation: 0...+ 80 °C (+ 32...+ 176 °F)
- Storage: - 10...+ 80 °C (+ 14...+ 176 °F)

Degree of protection according to IEC/EN 60529 IP65

## 2. Approvals and conformities

### 2.1. Conformity

In accordance with the Declaration of Conformity, the product is compliant with the EU Directives.

### 2.2. Standards

The applied standards which are used to demonstrate compliance with the EU Directives are listed in the EU-Type Examination Certificate and/or the EU Declaration of Conformity.

### 2.3. Pressure Equipment Directive (PED)

The device conforms to article 4, paragraph 1 of the Pressure Equipment Directive (PED) 2014/68/EU under the following conditions:

#### Device used on a pipe

##### Note:

- The data in the table is independent of the chemical compatibility of the material and the fluid.
- PS = maximum admissible pressure (in bar), DN = nominal diameter of the pipe

Type of fluid	Conditions
Fluid group 1, Article 4, Paragraph 1.c.i	$DN \leq 25$
Fluid group 2, Article 4, Paragraph 1.c.i	$DN \leq 32$ or $PS \cdot DN \leq 1000$
Fluid group 1, Article 4, Paragraph 1.c.ii	$DN \leq 25$ or $PS \cdot DN \leq 2000$
Fluid group 2, Article 4, Paragraph 1.c.ii	$DN \leq 200$ or $PS \leq 10$ or $PS \cdot DN \leq 5000$

## 3. Materials

### 3.1. Bürkert resistApp

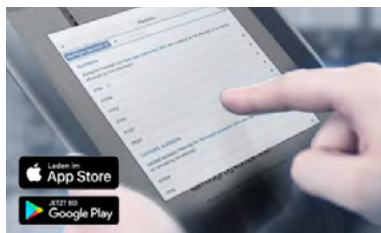

#### Bürkert resistApp – Chemical resistance chart

You want to ensure the reliability and durability of the materials in your individual application case? Verify your combination of media and materials on our website or in our resistApp.

[Start chemical resistance check](#)

## 4. Dimensions

### 4.1. Paddle wheel sensor with G 1/4" pipe connection

**Note:**

Dimensions in mm, unless otherwise stated

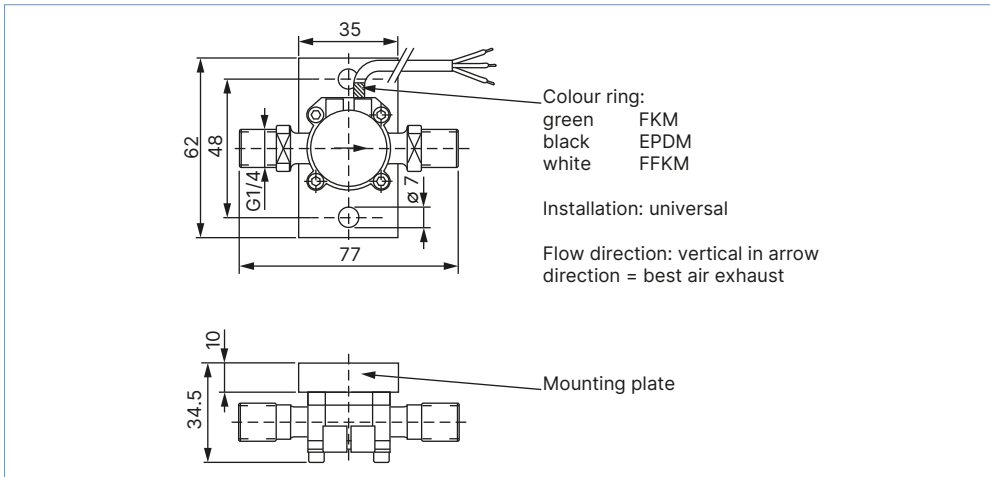

### 4.2. Paddle wheel sensor with 8/6 mm tube spigot pipe connection

**Note:**

Dimensions in mm, unless otherwise stated

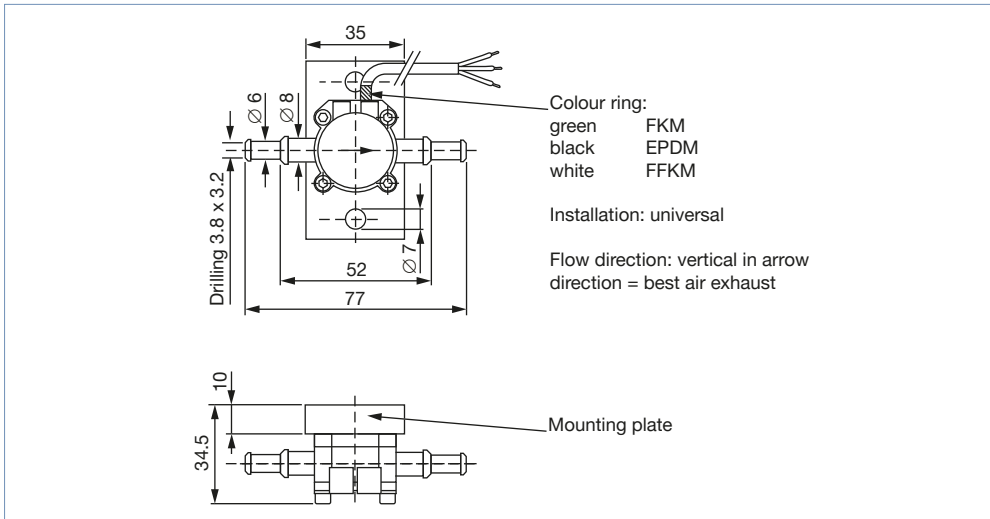

### 4.3. Paddle wheel sensor with 9 mm tube spigot pipe connection

**Note:**

Dimensions in mm, unless otherwise stated

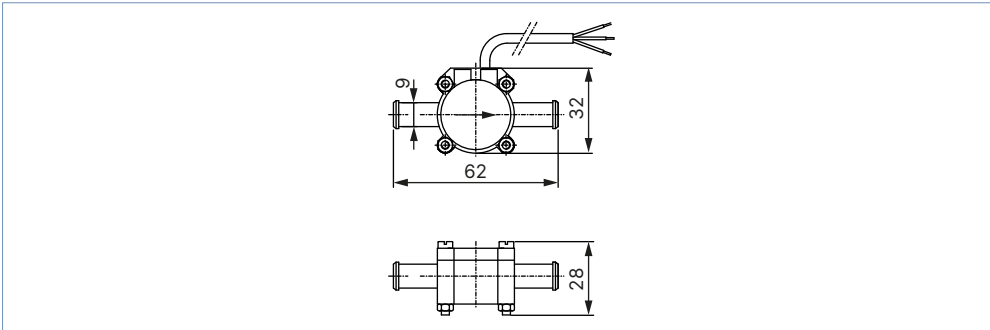

## 5. Performance specifications

### 5.1. Pressure loss diagram

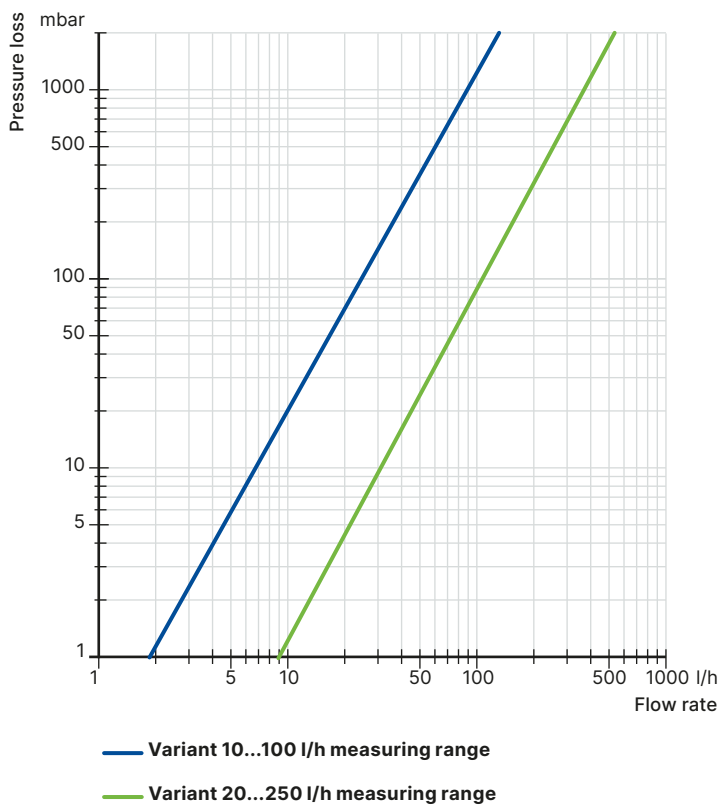

DTS 1000011083 EN Version: T Status: RL (released | freigegeben | validé) printed: 24.01.2025

## 5.2. Flow characteristic

### Determination of the K-factor

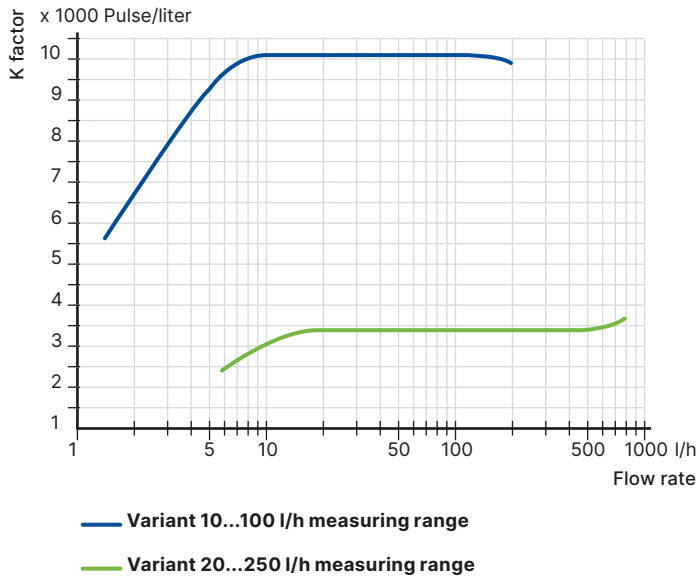

## 6. Ordering information

### 6.1. Bürkert eShop



#### Bürkert eShop – Easy ordering and quick delivery

You want to find your desired Bürkert product or spare part quickly and order directly? Our online shop is available for you 24/7. Sign up and enjoy all the benefits.

[Order online now](#)

### 6.2. Bürkert product filter















#### Bürkert product filter – Get quickly to the right product

You want to select products comfortably based on your technical requirements? Use the Bürkert product filter and find suitable articles for your application quickly and easily.

[Try out our product filter](#)

## 6.3. Ordering chart

Measuring range	Pipe connection	Output	Material			Article no.
			Housing, paddle wheel	Axis	Seal	
<b>Without mounting plate</b>						
10...100 l/h	Tube spigot 8/6 mm	Frequency push-pull	POM	Coated stainless steel	FKM	783717 
	G 1/4"					783719 
20...250 l/h	Tube spigot 9 mm					783718 
	G 1/4"					783720 
<b>With mounting plate</b>						
10...100 l/h	G 1/4"	Frequency push-pull	ECTFE	Sapphire	FKM	783721 
					EPDM	783722 
					FFKM	783723 
				Coated stainless steel	FKM	437982 
					EPDM	438531 
					FFKM	438532 
20...250 l/h	G 1/4"	Frequency push-pull	ECTFE	Sapphire	FKM	783724 
					EPDM	783725 
				Coated stainless steel	FFKM	783726 
					EPDM	437524 