



Insertion flowmeter or batch controller with paddle wheel and flow transmitter or remote batch controller

- Up to PN 10, measurement tube size DN 06 to DN 400
- Display for showing the flow rate and volume with two totalisers, or dosing
- Automatic calibration via teach-in
- Inputs (with batch controller) and all outputs can be checked without the need for actual flow
- Overall total and daily total for batch quantity and number of batches, volume or mass totalisers displayed (with batch controller)

Product variants described in the data sheet may differ from the product presentation and description.

Can be combined with

	Type 8611 eCONTROL – Universal controller	▶
	Type 8619 multiCELL – multi-channel/multi-function transmitter/controller	▶
	Type 8802 Continuous control valve systems ELEMENT – overview	▶
	Type 8644 AirLINE SP electropneumatic automation system	▶

Type description

Device Type 8025 is specially designed for use in neutral or mildly aggressive, particle-free liquids. The device is supplied as a flowmeter or batch controller, in a compact variant with paddle wheel sensor or in a remote variant.

Bürkert's proprietary fitting system permits simple installation of the compact device into pipelines from DN 20 to DN 400. The compact flowmeter is available with a standard signal output or without output (battery-operated display/totaliser).

Remote devices (flow transmitters or batch controllers) are intended for wall mounting or for panel mounting (for example, a control cabinet door). They must either be connected to a Bürkert flowmeter Type 8020, Type 8031, Type 8041 or Type SE30+S077, or to a flowmeter with open collector output, reed relay output, TTL, CMOS or solenoid.

DTS 1000011079 EN Version: AH Status: RL (released | freigegeben | valide) printed: 24.03.2026

Table of contents

1. General technical data	4
1.1. About the device.....	4
1.2. Flowmeter or compact batch controller	4
General data	4
Flowmeter	6
Compact batch controller	7
1.3. Flow transmitter or remote batch controller	9
General data	9
Universal flow transmitter	10
Flow transmitter for “Low Power” flowmeters.....	12
Remote batch controller	13
2. Product variants	14
2.1. Flowmeter	14
2.2. Compact batch controller	15
2.3. Universal flow transmitter	15
2.4. Flow transmitter for “Low Power” flowmeters.....	15
2.5. Remote batch controller	16
3. Approvals and conformities	17
3.1. General notes	17
3.2. Conformity	17
3.3. Standards.....	17
3.4. Pressure Equipment Directive (PED)	17
Device used in a pipe	17
3.5. North America (USA/Canada)	17
4. Materials	18
4.1. Bürkert resistApp	18
4.2. Material specifications	18
Flowmeter or compact batch controller	18
Flow transmitter or remote batch controller, panel variant	19
Flow transmitter or remote batch controller, wall-mounted variant	19
5. Dimensions	20
5.1. Flowmeter or compact batch controller	20
5.2. Flowmeter or compact batch controller installed in an Insertion fitting Type S020.....	21
5.3. Flow transmitter or remote batch controller	21
Universal flow transmitter, panel variant	21
Universal flow transmitter, wall-mounted variant	22
Flow transmitter for “Low Power” flowmeters, panel variant.....	22
Flow transmitter for “Low Power” flowmeters, wall-mounted variant.....	23
Remote batch controller, panel variant	23
Remote batch controller, wall-mounted variant.....	24
6. Performance specifications	24
6.1. Pressure temperature diagram	24
7. Product installation	25
7.1. Installation notes.....	25
Flow measurement.....	25
8. Product operation	26

8.1.	Measurement principle	26
	Flowmeter:	26
	Batch controller:	26
8.2.	Functional overview	26
	Display and operating keys	26
	Operating levels	28
8.3.	Function modes	31
	Flowmeter with standardized output signal	31
	Batch controller, compact or remote variants	31
9. Product design and assembly		32
9.1.	Product assembly	32
	Flowmeter or compact batch controller	32
	Flow transmitter or remote batch controller	32
10. Networking and combination with other Bürkert products		33
10.1.	Networking and combination of the compact device	33
	Flowmeter with standardized output signal	33
	Compact batch controller	33
10.2.	Combination of the compact device with available nominal diameter (DN) of Type S020 fittings	33
10.3.	Combination of the remote device	34
11. Ordering information		35
11.1.	Bürkert eShop	35
11.2.	Recommendation regarding product selection	35
	Compact flowmeter or compact batch controller	35
	Universal flow transmitter	35
	Flow transmitter for "Low Power" flowmeters	35
	Remote batch controller	36
11.3.	Bürkert product filter	36
11.4.	Ordering chart	36
	Flowmeter	36
	Compact batch controller	37
	Universal transmitter	37
	Flow transmitter for "Low Power" flowmeters	37
	Remote batch controller	38
11.5.	Ordering chart accessories	38
	Accessories for compact device	38
	Accessories for remote device	38

DTS 1000011079 EN Version: AH Status: RL (released | freigegeben | valide) printed: 24.03.2026

1. General technical data

1.1. About the device

The device Type 8025 is available in a compact variant as a flowmeter or as a batch controller or in a remote variant (wall-mounted or panel-mounted) as a flow transmitter or as a batch controller.



Furthermore, the compact flowmeter is available either as a measuring device with standard output signal or as a battery powered indicator/totalizer.

In addition, the flow transmitter is available in two variants: a Universal variant and a variant for Bürkert "Low Power" flowmeters.

1.2. Flowmeter or compact batch controller

General data

The following data are valid for both the flowmeter and the batch controller.

Product properties

Material

Make sure the device materials are compatible with the fluid you are using.
Further information can be found in chapter ["4.1. Bürkert resistApp" on page 18.](#)

Further information on the materials can be found in chapter ["4.2. Material specifications" on page 18.](#)

Non-wetted parts

Lid	PC
Front panel film	Polyester
Cover	PC
Housing	PC
Screw	Stainless steel
Union nut	PC
Seal	NBR
Female cable plug/male fixed plug	<ul style="list-style-type: none"> Body, contact holder and cable gland in PA Cable gland seal and flat seal in NBR
Cable gland	PA

Wetted parts

Sensor armature	PVDF
Axis and bearing	Ceramics (Al ₂ O ₃)
Paddle wheel	PVDF
Seal	FKM standard (EPDM included, but not mounted)

Display	15 × 60 mm, 8-digit LCD, alphanumeric, 15 segments, 9 mm high
Compatibility	Any pipe from DN 20 ¹⁾ ...DN 400 which is fitted with Bürkert Type S020 Insertion fitting. For the selection of the nominal diameter of the fittings, see data sheet Type S020 ►.
Pipe diameter	DN 20 ¹⁾ ...DN 400
Dimensions	Further information can be found in chapter "5. Dimensions" on page 20.
Measurement principle	Paddle wheel
Measuring range	<ul style="list-style-type: none"> Flow rate: 0.5...75000 l/min Flow velocity: 0.3...10 m/s

Performance data

Measurement deviation	<ul style="list-style-type: none"> Teach-in: $\pm 1\%$ of the measured value^{2.)} at teach-in flow rate value Standard K factor: $\pm 2.5\%$ of the measured value^{1.)}
Linearity	$\pm 0.5\%$ of full scale ^{2.)}
Repeatability	$\pm 0.4\%$ of the measured value ^{2.)}

Electrical data

Power source (not supplied)	Limited power source according to UL/EN 62368-1 standards or limited energy circuit according to UL/EN 61010-1 paragraph 9.4
DC reverse polarity protection	Yes
Overvoltage protection	Yes
Voltage supply cable	<ul style="list-style-type: none"> Cable with maximum operating temperature greater than 80 °C (176 °F) (90 °C (194 °F) for UL-Recognized variant) Max. 50 m length, shielded

Medium data

Fluid temperature	With fitting Type S020 in: <ul style="list-style-type: none"> PVC: 0...+ 50 °C (+ 32...+ 122 °F) PP: 0...+ 80 °C (+ 32...+ 176 °F) PVDF, stainless steel or brass: - 15...+ 80 °C (+ 5...+ 176 °F) (up to + 100 °C (212 °F) for flowmeter with batteries) See data sheet Type S020 ► for more information.
Fluid pressure	Max. PN 10 See data sheet Type S020 ► for more information.
Viscosity	Max. 300 cSt
Rate of solid particles	Max. 1%
Maximum particle size	0.5 mm

Product connections

Process connection	G 2 for use with Type S020 Insertion fitting See data sheet Type S020 ► for more information.
--------------------	---------------------------------------------------------------------------------------------------------

Approvals and conformities

Directives

CE directive	Further information on the CE directive can be found in chapter "3.3. Standards" on page 17.
Pressure equipment directive	Complying with article 4, paragraph 1 of 2014/68/EU directive Further information on the pressure equipment directive can be found in chapter "3.4. Pressure Equipment Directive (PED)" on page 17.
North America (USA/Canada)	UL Recognized for the USA and Canada

Environment and installation

Relative air humidity	$\leq 80\%$, without condensation
Height above sea level	Max. 2000 m
Operating condition	Continuous
Equipment mobility	Fixed
Application range	Indoor and outdoor Protect the device against electromagnetic interference, ultraviolet rays and, when installed outdoors, against the effects of climatic conditions.
Degree of protection ^{3.)} according to IEC/EN 60529	IP65 with the following conditions met: <ul style="list-style-type: none"> device wired cover and lid screwed tight female cable plug or glands mounted and tightened with blind plug on unused cable glands
Installation category	Category I according to UL/EN 61010-1
Pollution degree	Degree 2 according to UL/EN 61010-1

1.) Restricted to some Insertion fitting process connections

2.) Under reference conditions i.e. measurement medium = water, ambient and water temperature = + 20 °C (+ 68 °F), observing the minimum inlet and outlet sections and the appropriate inner diameter of the pipe.

3.) Not evaluated by UL

Flowmeter

Note:

If the device is mounted in a humid environment or outside, then the maximum voltage allowed is **35 V DC** instead of 36 V DC.

Performance data

4...20 mA output uncertainty ± 1% of current range

Electrical data

Operating voltage (V+)	Measuring device with standard output signal <ul style="list-style-type: none"> • 12...36 V DC ± 10%, filtered and regulated Connection to main supply: permanent, through external SELV (Safety Extra Low Voltage) and LPS (Limited Power Source) power supply • 115/230 V AC, 50/60 Hz Voltage supply available inside the device: <ul style="list-style-type: none"> – supplied voltage: 27 V DC regulated – maximum current: 125 mA – integrated protection: 125 mA time delay fuse
Current consumption	Battery powered indicator/totalizer <ul style="list-style-type: none"> • 4 × 1.5 V DC non-rechargeable alkaline AA batteries, lifetime 4 years at 20 °C (68 °F) 12...36 V DC powered measuring device with standard output signal, with sensor and without pulse output consumption <ul style="list-style-type: none"> • With relays: ≤ 70 mA • Without relay: ≤ 25 mA
Power consumption	115/230 V AC powered measuring device: 3 VA
Output	Measuring device with standard output signal <ul style="list-style-type: none"> • Transistor (pulse): <ul style="list-style-type: none"> – potential free – NPN or PNP (wiring dependant) – function: pulse output, adjustable pulse value – 0...400 Hz – 5...36 V DC, 100 mA, voltage drop at 100 mA: 2.5 V DC – duty cycle (pulse duration/period): 0.5 – galvanic insulation and protected against overvoltage, polarity reversals and short circuit • Relay: <ul style="list-style-type: none"> – 2 relays, normally open, hysteresis, adjustable thresholds – non UL Recognized device: 230 V AC/3 A or 40 V DC/3 A (resistive load) – UL Recognized device: 30 V AC/42 V_{peak}/3 A or 60 V DC/1 A • Current: <ul style="list-style-type: none"> – 4...20 mA (3-wire with relays, 2-wire without relay) – sourcing or sinking (wiring dependant) – max. loop impedance: 900 Ω at 30 V DC, 600 Ω at 24 V DC, 50 Ω at 12 V DC, 800 Ω with a 115/230 V AC voltage supply – response time (10...90 %) for the measured value: 6 s (default) Battery powered indicator/totalizer <ul style="list-style-type: none"> • Without output

Voltage supply cable	Measuring device with standard output signal <ul style="list-style-type: none"> External diameter (cable): <ul style="list-style-type: none"> 5...8 mm (with cable plug) 6...12 mm (1 cable per cable gland) or 3...5 mm when using a multi-way seal (2 cables per cable gland) Cross section of wires: <ul style="list-style-type: none"> 0.25...1.5 mm² (with cable plug) 0.75 mm² (with cable gland) Cross section of the local ground wire: max. 0.75 mm²
	Battery powered indicator/totalizer <ul style="list-style-type: none"> None

Product connections

Electrical connection	<ul style="list-style-type: none"> Variant 12...36 V DC: cable plug or cable glands M20 × 1.5 Variant with batteries: None
-----------------------	----------------------------------------------------------------------------------------------------------------------------------------------------

Environment and installation

Ambient temperature	Operation and storage: <ul style="list-style-type: none"> variant 12...36 V DC: -10...+60 °C (+5...+140 °F) variant 115/230 V AC: -10...+50 °C (+5...+122 °F) variant with batteries: -10...+55 °C (+5...+131 °F)
---------------------	----------------------------------------------------------------------------------------------------------------------------------------------------------------------------------------------------------------------------------------------------

Compact batch controller

Note:

If the device is mounted in a humid environment or outside, then the maximum voltage allowed is **35 V DC** instead of 36 V DC.

Electrical data

Operating voltage (V+)	<ul style="list-style-type: none"> 12...36 V DC, max tolerance: -5 % or +10 % at 12 V DC, ±10 % at 36 V DC, filtered and regulated Connection to main supply: permanent, through external SELV (Safety Extra Low Voltage) and LPS (Limited Power Source) power supply 115/230 V AC, 50/60 Hz Voltage supply available inside the device: <ul style="list-style-type: none"> supplied voltage: 27 V DC regulated maximum current: 125 mA integrated protection: 125 mA time delay fuse
Current consumption	With sensor, without consumption of digital input and pulse output <ul style="list-style-type: none"> With relays: <ul style="list-style-type: none"> ≤ 100 mA (at 12 V DC) ≤ 50 mA (at 36 V DC) ≤ 55 mA (115/230 V AC) Without relay: <ul style="list-style-type: none"> ≤ 70 mA (at 12 V DC) ≤ 35 mA (at 36 V DC) ≤ 40 mA (115/230 V AC)
Power consumption	115/230 V AC powered measuring device: 3 VA
Input	<ul style="list-style-type: none"> DI (1 to 4) Switching threshold V_{on}: 5...36 V DC Switching threshold V_{off} max.: 2 V DC Min. pulse duration: 100 ms Input impedance: 9.4 kΩ Galvanic insulation, protected against polarity reversals and voltage spike

Output	<ul style="list-style-type: none"> • Transistors (digital outputs DO1 and DO4): <ul style="list-style-type: none"> – potential-free – NPN or PNP (wiring dependant) – function: pulse output (by default for DO1), batch state (by default for DO4), configurable and parametrizable – 0...300 Hz – 5...36 V DC, 100 mA max., voltage drop at 100 mA: 2.7 V DC – duty cycle (pulse duration/period): > 0.45 – galvanic insulation, protected against overvoltage, polarity reversals and short-circuits • Relays (digital outputs DO2 and DO3): <ul style="list-style-type: none"> – 2 relays, normally open, parametrizable (by default: DO2 always configured to control the valve, parametrized of 100 % of the batch quantity and DO3 configured as alarm) – non UL Recognized device: 230 V AC/3 A or 40 V DC/3 A (resistive load) – UL Recognized device: 30 V AC/42 V_{peak}/3 A or 60 V DC/1 A – max. cutting power of 750 VA (resistive load)
--------	------------------------------------------------------------------------------------------------------------------------------------------------------------------------------------------------------------------------------------------------------------------------------------------------------------------------------------------------------------------------------------------------------------------------------------------------------------------------------------------------------------------------------------------------------------------------------------------------------------------------------------------------------------------------------------------------------------------------------------------------------------------------------------------------------------------------------------------------------------------------------------------------------------------------------------------------------------------------------------------------------------------------------------------------------------------------------------------------------------------------------------

Voltage supply cable	<ul style="list-style-type: none"> • External diameter (cable): <ul style="list-style-type: none"> – 6...12 mm (1 cable per cable gland) or – 4 mm when using a multi-way seal (2 cables per cable gland) • Cross section of wires: 0.75 mm²
----------------------	----------------------------------------------------------------------------------------------------------------------------------------------------------------------------------------------------------------------------------------------------------------------------------------------------------------------

Product connections

Electrical connection	Cable glands M20 × 1.5
-----------------------	------------------------

Environment and installation

Ambient temperature	<p>Operation and storage:</p> <ul style="list-style-type: none"> • variant 12...36 V DC: -10...+ 60 °C (+ 5...+ 140 °F) • variant 115/230 V AC: -10...+ 50 °C (+ 5...+ 122 °F)
---------------------	--------------------------------------------------------------------------------------------------------------------------------------------------------------------------------------------------------

DTS 1000011079 EN Version: AH Status: RL (released | freigegeben | valide) printed: 24.03.2026

1.3. Flow transmitter or remote batch controller

General data

The following data are valid for the universal flow transmitter, for the flow transmitter for "Low Power" flowmeters as well as for the remote batch controller.

Product properties

Material

Make sure the device materials are compatible with the fluid you are using.

Further information can be found in chapter "4.1. Bürkert resistApp" on page 18.

Further information on the materials can be found in chapter "4.2. Material specifications" on page 18.

Non-wetted parts

Front panel film	Polyester
Cover	ABS (wall-mounted variant)
Housing	<ul style="list-style-type: none"> • PC (panel-mounted variant) • ABS (wall-mounted variant)
Screw	Stainless steel
Seal	NBR
Cable gland	PA (wall-mounted variant)
Cable clamp	PA (panel-mounted variant)
Display	15 × 60 mm, 8-digit LCD, alphanumeric, 15 segments, 9 mm high
Dimensions	Further information can be found in chapter "5. Dimensions" on page 20.

Electrical data

Power source (not supplied)	Limited power source according to UL/EN 62368-1 standards or limited energy circuit according to UL/EN 61010-1 paragraph 9.4
DC reverse polarity protection	Yes
Overvoltage protection	Yes
Voltage supply cable	<ul style="list-style-type: none"> • Cable with maximum operating temperature greater than 80 °C (90 °C for UL Recognized variant) • Max. 50 m length, shielded • Cross section of wires: 0.2...1.5 mm²

Product connections

Electrical connection	<ul style="list-style-type: none"> • Panel-mounted variant: terminals • Wall-mounted variant: terminals via gland M16 × 1.5
-----------------------	-----------------------------------------------------------------------------------------------------------------------------------------------------

Approvals and conformities

Directives

CE directive	Further information on the CE directive can be found in chapter "3.3. Standards" on page 17.
North America (USA/Canada)	UL Recognized for US and Canada

Environment and installation

Ambient temperature	Operation and storage: - 10...+ 60 °C (+ 14...+ 140 °F)
Relative air humidity	≤ 80 %, without condensation
Height above sea level	Max. 2000 m
Operating condition	Continuous
Equipment mobility	Fixed
Application range	Indoor and outdoor Protect the device against electromagnetic interference, ultraviolet rays and, when installed outdoors, against the effects of climatic conditions.
Degree of protection ¹⁾ according to EN 60529	<ul style="list-style-type: none"> • Panel-mounted variant: <ul style="list-style-type: none"> – front side: IP65 installation completed and closed cabinet – rear side: IP20 inside the closed cabinet • Wall-mounted variant: <ul style="list-style-type: none"> – IP65 with the following conditions met: <ul style="list-style-type: none"> – device wired – cover screwed tight – female cable plug or glands mounted and tightened – with blind plug on unused cable glands

1.) Not evaluated by UL

Universal flow transmitter

Note:

If the device is mounted in a humid environment or outside, then the maximum voltage allowed is **35 V DC** instead of 36 V DC.

Product properties	
Compatibility	Bürkert flowmeter with frequency output (Types 8020, 8030, 8030HT, 8041, 8031, SE30+S077, 8071, 8077) or other sensors with compatible electrical data
Performance data	
4...20 mA output uncertainty	± 1 % of current range
Electrical data	
Operating voltage (V+)	<ul style="list-style-type: none"> • Panel-mounted variant: <ul style="list-style-type: none"> – 12...36 V DC, max tolerance: - 5 % or + 10 % at 12 V DC, ± 10 % at 36 V DC, filtered and regulated Connection to main supply: permanent, through external SELV (Safety Extra Low Voltage) and LPS (Limited Power Source) power supply • Wall-mounted variant: <ul style="list-style-type: none"> – 12...36 V DC, max tolerance: - 5 % or + 10 % at 12 V DC, ± 10 % at 36 V DC, filtered and regulated Connection to main supply: permanent, through external SELV (Safety Extra Low Voltage) and LPS (Limited Power Source) power supply – 115/230 V AC, 50/60 Hz Voltage supply available inside the device: <ul style="list-style-type: none"> – supplied voltage: 27 V DC regulated – maximum current: 250 mA – integrated protection: 250 mA time delay fuse
Current consumption	Without sensor and without consumption of 4...20 mA output of the flowmeter <ul style="list-style-type: none"> • With relays: <ul style="list-style-type: none"> – ≤ 70 mA (at 12 V DC) – ≤ 45 mA (at 36 V DC) – ≤ 50 mA (115/230 V AC, wall-mounted variant) • Without relay: <ul style="list-style-type: none"> – ≤ 50 mA (at 12 V DC) – ≤ 30 mA (at 36 V DC) – ≤ 35 mA (115/230 V AC, wall-mounted variant)
Power consumption	115/230 V AC powered measuring device: 6 VA
Device input (from sensor)	<ul style="list-style-type: none"> • Frequency range: 0.6 Hz...2.2 kHz, can be adjusted • Voltage: max. 36 V DC • Type of the signal: <ul style="list-style-type: none"> – pulse: open collector NPN (with 470 Ω or 2.2 kΩ resistance) or PNP, TTL, CMOS (with 39 kΩ resistance) – sine-wave, coil (with 39 kΩ resistance and with minimum sensitivity of 50 mV peak to peak)
Device output (to sensor)	<ul style="list-style-type: none"> • Voltage supply with a powered 12...36 V DC transmitter: <ul style="list-style-type: none"> – 10.5...34.5 V DC [= (V+) - 1.5 V DC], 140 mA max. – 0...23.5 V DC [= (V+) - 12.5 V DC], 80 mA max. – 5 V DC, 30 mA max. • Voltage supply with a powered 115/230 V AC transmitter: <ul style="list-style-type: none"> – + 27 V DC, 80 mA max. – + 14.5 V DC [= (V+) - 12.5 V DC] 80 mA max. – 5 V DC, 30 mA max.

Output	<ul style="list-style-type: none"> • Transistor (digital output DO1): <ul style="list-style-type: none"> – potential free – NPN or PNP (wiring dependant) – function: pulse output, adjustable pulse value – 0...2200 Hz – 5...36 V DC, 100 mA max., voltage drop at 100 mA: 2.7 V DC – duty cycle (pulse duration/period): <ul style="list-style-type: none"> – > 0.45 if 0.6 < frequency < 300 Hz – > 0.4 if 300 < frequency < 1500 Hz – < 0.4 if 1500 < frequency < 2200 Hz – galvanic insulation, protected against overvoltage, polarity reversals and short-circuit • Relays (digital outputs DO2 and DO3): <ul style="list-style-type: none"> – 2 relays, normally open, hysteresis, adjustable thresholds – non UL Recognized device: 230 V AC/3 A or 40 V DC/3 A (resistive load) – UL Recognized device: 30 V AC/42 V_{peak}/3 A or 60 V DC/1 A – max. cutting power of 750 VA (resistive load) – life span of min. 100 000 cycles • Current (analogue output AO1): <ul style="list-style-type: none"> – 4...20 mA (3-wire) – sourcing or sinking (wiring dependant) – 22 mA to indicate an error (can be activated) – max. loop impedance: 1300 Ω at 36 V DC, 1000 Ω at 30 V DC, 750 Ω at 24 V DC, 300 Ω at 15 V DC, 200 Ω at 12 V DC, 900 Ω with a 115/230 V AC voltage supply
Voltage supply cable	<ul style="list-style-type: none"> • Wall-mounted variant: <ul style="list-style-type: none"> – external diameter (cable): 4...8 mm (for the cable glands)

Flow transmitter for "Low Power" flowmeters
Note:

If the device is mounted in a humid environment or outside, then the maximum voltage allowed is **35 V DC** instead of 36 V DC.

Product properties	
Compatibility	Bürkert flowmeter with frequency output (Types 8020, 8030, SE30+S077) in "Low Power" pulse signal variant
Performance data	
4...20 mA output uncertainty	± 1 % of current range
Electrical data	
Operating voltage (V+)	<ul style="list-style-type: none"> • Panel-mounted variant: <ul style="list-style-type: none"> – 12...36 V DC ± 10 %, filtered and regulated Connection to main supply: permanent, through external SELV (Safety Extra Low Voltage) and LPS (Limited Power Source) power supply • Wall-mounted variant: <ul style="list-style-type: none"> – 12...36 V DC ± 10 %, filtered and regulated Connection to main supply: permanent, through external SELV (Safety Extra Low Voltage) and LPS (Limited Power Source) power supply – 115/230 V AC, 50/60 Hz Voltage supply available inside the device: <ul style="list-style-type: none"> – supplied voltage: 27 V DC regulated – maximum current: 250 mA – integrated protection: 250 mA time delay fuse
Current consumption	With sensor and without pulse output consumption <ul style="list-style-type: none"> • With relays: ≤ 70 mA • Without relay: ≤ 25 mA
Power consumption	115/230 V AC powered measuring device: 6 VA
Device input (from sensor)	<ul style="list-style-type: none"> • Frequency range: 2.5...400 Hz • Pulse signal (Hall): "Low Power", NPN Open Collector
Device output (to sensor)	Voltage supply 10...34 V DC [= (V+) - 2 V DC], 1 mA max.
Output	<ul style="list-style-type: none"> • Transistor (pulse): <ul style="list-style-type: none"> – potential free – NPN or PNP (wiring dependant) – function: pulse output, adjustable pulse value – 0...400 Hz – 5...36 V DC, 100 mA, voltage drop at 100 mA: 2.5 V DC – duty cycle (pulse duration/period): 0.5 – galvanic insulation and protected against overvoltage, polarity reversals and short circuit • Relay: <ul style="list-style-type: none"> – 2 relays, normally open, hysteresis, adjustable thresholds – non UL Recognized device: 230 V AC/3 A or 40 V DC/3 A (resistive load) – UL Recognized device: 30 V AC/42 V_{peak}/3 A or 60 V DC/1 A • Current: <ul style="list-style-type: none"> – 4...20 mA (3-wire with relays, 2-wire without relay) – sourcing or sinking (wiring dependant) – max. loop impedance: 900 Ω at 30 V DC, 600 Ω at 24 V DC, 50 Ω at 12 V DC, 800 Ω with a 115/230 V AC voltage supply – response time (10...90 % for the measured value: 6 s (default)
Voltage supply cable	<ul style="list-style-type: none"> • Wall-mounted variant: <ul style="list-style-type: none"> – external diameter (cable): 4...8 mm (for the cable glands)

Remote batch controller

Note:

If the device is mounted in a humid environment or outside, then the maximum voltage allowed is **35 V DC** instead of 36 V DC.

Product properties	
Compatibility	Bürkert flow sensor with frequency output (Types 8020, 8030, 8030HT, 8041, 8031, 8070, 8071, 8077) or other sensors with compatible electrical data
Electrical data	
Operating voltage (V+)	<ul style="list-style-type: none"> 12...36 V DC, max tolerance: - 5 % or + 10 % at 12 V DC, ± 10 % at 36 V DC, filtered and regulated Connection to main supply: permanent, through external SELV (Safety Extra Low Voltage) and LPS (Limited Power Source) power supply 115/230 V AC, 50/60 Hz Voltage supply available inside the device: <ul style="list-style-type: none"> – supplied voltage: 27 V DC regulated – maximum current: 250 mA – integrated protection: 250 mA time delay fuse
Current consumption	With sensor and without consumption of 4...20 mA output of the flowmeter <ul style="list-style-type: none"> • With relays: <ul style="list-style-type: none"> – ≤ 70 mA (at 12 V DC) – ≤ 45 mA (at 36 V DC) – ≤ 50 mA (115/230 V AC, wall-mounted variant) • Without relay: <ul style="list-style-type: none"> – ≤ 50 mA (at 12 V DC) – ≤ 30 mA (at 36 V DC) – ≤ 35 mA (115/230 V AC, wall-mounted variant)
Power consumption	115/230 V AC powered measuring device: 6 VA
Device input (from sensor)	<ul style="list-style-type: none"> • Frequency range: 0.6 Hz...2.2 kHz • Voltage: Max. 36 V DC • Type of the signal: <ul style="list-style-type: none"> – pulse: open collector NPN (with 470 Ω or 2.2 kΩ resistance) or PNP, TTL, CMOS (with 39 kΩ resistance) – sine-wave: coil (with 39 kΩ resistance)
Device output (to sensor)	<ul style="list-style-type: none"> • Voltage supply with a powered 12...36 V DC transmitter: <ul style="list-style-type: none"> – 10.5...34.5 V DC [= (V+) - 1.5 V DC], 140 mA max. – 0...23.5 V DC [= (V+) - 12.5 V DC], 80 mA max. – 5 V DC, 30 mA max. • Voltage supply with a powered 115/230 V AC transmitter: <ul style="list-style-type: none"> – + 27 V DC, 80 mA max. – + 14.5 V DC [= (V+) - 12.5 V DC] 80 mA max. – 5 V DC, 30 mA max.
Input	<ul style="list-style-type: none"> • DI (1 to 4) • Switching threshold V_{on}: 5...36 V DC • Switching threshold V_{off} max.: 2 V DC • Min. pulse duration: 100 ms • Input impedance: 9.4 kΩ • Galvanic insulation, protected against polarity reversals and voltage spike

Output	<ul style="list-style-type: none"> • Transistors (digital outputs DO1 and DO4): <ul style="list-style-type: none"> – potential free – NPN or PNP (wiring dependent) – function: pulse output (by default for DO1), state (by default for DO4), configurable and parametrizable – 0...2200 Hz, – 5...36 V DC, 100 mA max., voltage drop at 100 mA: 2.7 V DC – duty cycle (pulse duration/period): <ul style="list-style-type: none"> – > 0.45 if 0.6 < frequency < 300 Hz – > 0.4 if 300 < frequency < 1500 Hz – < 0.4 if 1500 < frequency < 2200 Hz – galvanic insulation, protected against overvoltage, polarity reversals and short-circuits • Relays (digital outputs DO2 and DO3): <ul style="list-style-type: none"> – 2 relays, normally open, parametrizable (by default: DO2 always configured to control the valve, parametrised of 100 % of the batch quantity and DO3 configured as alarm) – non UL Recognized device: 230 V AC/3 A or 40 V DC/3 A (resistive load) – UL Recognized device: 30 V AC/42 V_{peak}/3 A or 60 V DC/1 A – max. cutting power of 750 VA (resistive load)
Voltage supply cable	<ul style="list-style-type: none"> • Wall-mounted variant: <ul style="list-style-type: none"> – external diameter (cable): 5...8 mm (for the cable glands)

2. Product variants

2.1. Flowmeter

The compact variant is available in two variants:

- Insertion flowmeter with standard output signal (4...20 mA, frequency)
- Insertion flowmeter as battery powered indicator/totalizer



Flowmeter with standard output signal

The device operates on a 2- or 3-wire system and needs a 12...36 V DC or a 115/230 V AC power supply.

The device is equipped with:

- an analogue output (4...20 mA current output)
- a digital output (pulse output) and
- two totalizers.

Some variants are also fitted with two fully configurable relay outputs.

The device allows:

- through the digital or relay outputs
 - to switch a solenoid valve
 - to activate an alarm
 - to generate a flow rate proportional frequency
- through the analogue output to establish a control loop.



Flowmeter as battery powered indicator/totalizer

The device has no output and displays the instantaneous value as well as the amount of liquid that has flowed through.

2.2. Compact batch controller



The device needs a voltage supply of 12...36 V DC or 115/230 V AC.

The device is equipped with:

- four digital inputs (DI1 to DI4),
- two transistor outputs (DO1 configured as a pulse output and DO4 configured as state output, by default),
- two relay outputs (DO2 always configured to control the valve and by default parametrise of 100% of the batch quantity and DO3 configured as alarm output by default),
- two volume or mass totalizers and two totalizers for the number of batches performed.

The second relay output can be used to activate another valve, to initiate alarms or to generate warnings.

When mounted in a pipe in series with one or two valves, the batch controller makes it possible to carry out a dosing of one or several quantities of liquids. The unit controls the opening of the valves and measures the quantity of the fluid which flows. The unit also closes the valves when the pre-set quantity has been delivered.

2.3. Universal flow transmitter



The transmitter is available in wall-mounted and panel variants.

The transmitter can be associated with Bürkert flowmeter (e.g. Type 8020, 8030, SE30+S077). See chapter ["10.3. Combination of the remote device"](#) on page 34 for more information. Another flow sensor emitting a frequency signal (pulse signal) can also be connected.

The transmitter operates on a 3-wire system and needs a 12...36 V DC or a 115/230 V AC power supply.

The transmitter is equipped with:

- an analogue output (4...20 mA current output, called AO1)
- a digital output (configured as a pulse output by default, called DO1)
- two totalizers.

Some variants are also fitted with two fully configurable relay outputs (called DO2 and DO3).

When connected to a flowmeter, the transmitter allows:

- through the digital or relay outputs
 - to switch a solenoid valve
 - to activate an alarm
 - to generate a flow rate proportional frequency
- through the analogue output to establish a control loop.

2.4. Flow transmitter for "Low Power" flowmeters



The transmitter is available in wall-mounted and panel variants.

The transmitter variant can only be associated with Bürkert flowmeter (e.g. Type 8020, 8030, SE30+S077) with sinus or pulse output signal **in a "Low Power" variant**. See chapter ["10.3. Combination of the remote device"](#) on page 34 for more information.

The transmitter operates on a 2- or 3-wire system and needs a 12...36 V DC or a 115/230 V AC power supply.

The device is equipped with:

- an analogue output (4...20 mA current output)
- a digital output (pulse output)
- two totalizers.

Some variants are also fitted with two fully configurable relay outputs.

When connected to a flowmeter, the transmitter allows:

- through the digital or relay outputs
 - to switch a solenoid valve
 - to activate an alarm
 - to generate a flow rate proportional frequency
- through the analogue output to establish a control loop.

2.5. Remote batch controller



The device is available in wall-mounted and panel variants.

The device can be associated with Bürkert flowmeters (e.g. Type 8020, 8030, SE30+S077). See chapter **“10.3. Combination of the remote device” on page 34** for more information. Another flow sensor emitting a frequency signal (pulse signal) can also be connected.



The device needs a voltage supply of 12...36 V DC or 115/230 V AC.

The device is equipped with:

- four digital inputs (DI1 to DI4),
- two transistor outputs (DO1 configured as a pulse output and DO4 configured as state output, by default),
- two relay outputs (DO2 always configured to control the valve and by default parametrise of 100% of the batch quantity and DO3 configured as alarm output by default),
- two volume or mass totalizers and two totalizers for the number of batches performed.

The second relay output can be used to activate another valve, to initiate alarms or to generate warnings.

When the batch controller is connected to a flowmeter in series with one or two valves, dosing of one or several quantities of liquids can be carried out. The device controls the opening of the valves and measures the quantity of the fluid which flows. The device also closes the valves when the pre-set quantity has been delivered.

3. Approvals and conformities

3.1. General notes

- The approvals and conformities listed below must be stated when making enquiries. This is the only way to ensure that the product complies with all required specifications.
- Not all available variants can be supplied with the below mentioned approvals or conformities.

3.2. Conformity

In accordance with the Declaration of Conformity, the product is compliant with the EU Directives.

3.3. Standards

The applied standards which are used to demonstrate compliance with the EU Directives are listed in the EU-Type Examination Certificate and/or the EU Declaration of Conformity.

3.4. Pressure Equipment Directive (PED)

The device conforms to Article 4, Paragraph 1 of the Pressure Equipment Directive 2014/68/EU under the following conditions:

Device used in a pipe

Note:

- The data in the table is independent of the chemical compatibility of the material and the fluid.
- PS = maximum admissible pressure (in bar), DN = nominal diameter of the pipe

Type of fluid	Conditions
Fluid group 1, Article 4, Paragraph 1.c.i	DN ≤ 25
Fluid group 2, Article 4, Paragraph 1.c.i	DN ≤ 32 or PS*DN ≤ 1000
Fluid group 1, Article 4, Paragraph 1.c.ii	DN ≤ 25 or PS*DN ≤ 2000
Fluid group 2, Article 4, Paragraph 1.c.ii	DN ≤ 200 or PS ≤ 10 or PS*DN ≤ 5000

3.5. North America (USA/Canada)

Approval	Description
	Optional: UL Recognized for the USA and Canada The products are UL Recognized for the USA and Canada according to: <ul style="list-style-type: none"> • UL 61010-1 (ELECTRICAL EQUIPMENT FOR MEASUREMENT, CONTROL, AND LABORATORY USE – Part 1: General Requirements) • CAN/CSA-C22.2 No. 61010-1

4. Materials

4.1. Bürkert resistApp

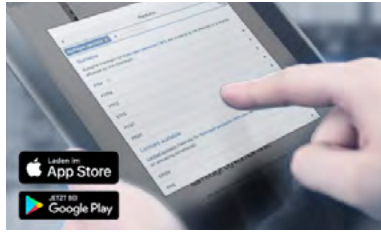

Bürkert resistApp – Chemical resistance chart

You want to ensure the reliability and durability of the materials in your individual application case? Verify your combination of media and materials on our website or in our resistApp.

[Start chemical resistance check](#)

4.2. Material specifications

Flowmeter or compact batch controller

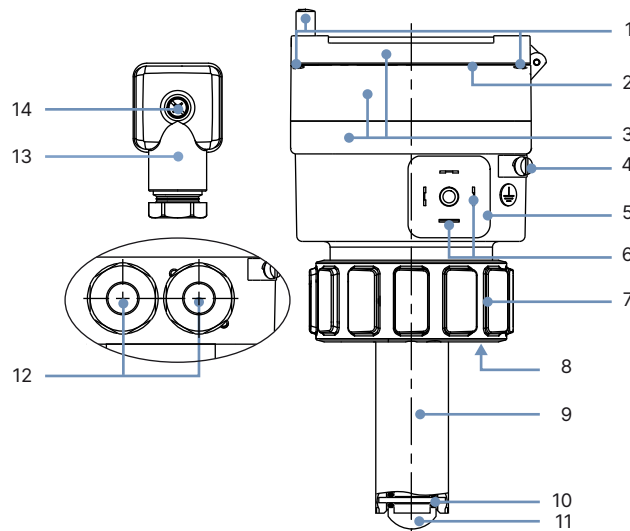

No.	Element	Material
1	Screws	Stainless steel
2	Front panel foil	Polyester
3	Housing, cover, lid	PC
4	Screw	Stainless steel
5	Male fixed plug (DIN EN 175301-803)	PA
6	Electrical contact	Sn
7	Nut	PC
8	Seal	FKM (EPDM included, but not mounted)
9	Sensor armature	PVDF
10	Axis and bearing	Ceramics (Al ₂ O ₃)
11	Paddle wheel	PVDF
12	M20 × 1.5 cable gland	PA
13	Female cable plug (DIN EN 175301-803)	<ul style="list-style-type: none"> • Body, contact holder and cable gland in PA • Cable gland seal and flat seal in NBR
14	Screw	Stainless steel

Flow transmitter or remote batch controller, panel variant

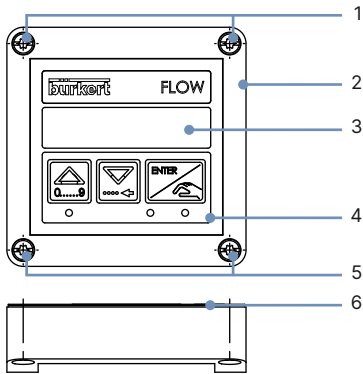

No.	Element	Material
1	Screws	Stainless steel
2	Housing	PC
3	Window	PPMA
4	Front panel foil	Polyester
5	Screws	Stainless steel
6	Seal	NBR
-	Cable clip (at the back of the housing)	PA

Flow transmitter or remote batch controller, wall-mounted variant

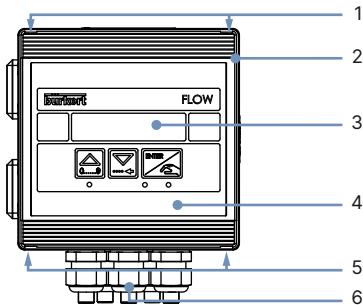

No.	Element	Material
1	Screws (under the cover plate)	Stainless steel
2	Housing and cover	ABS
3	Window	PPMA
4	Front panel foil	Polyester
5	Screws (under the cover plate)	Stainless steel
6	Cable glands	PA
-	Seal (between housing and cover)	NBR

5. Dimensions

5.1. Flowmeter or compact batch controller

Note:

- Dimensions in mm, unless otherwise stated
- The length of the flow probe depends on the used Insertion fitting Type S020 and its nominal diameter, see **data sheet Type S020** ▶ for more information.

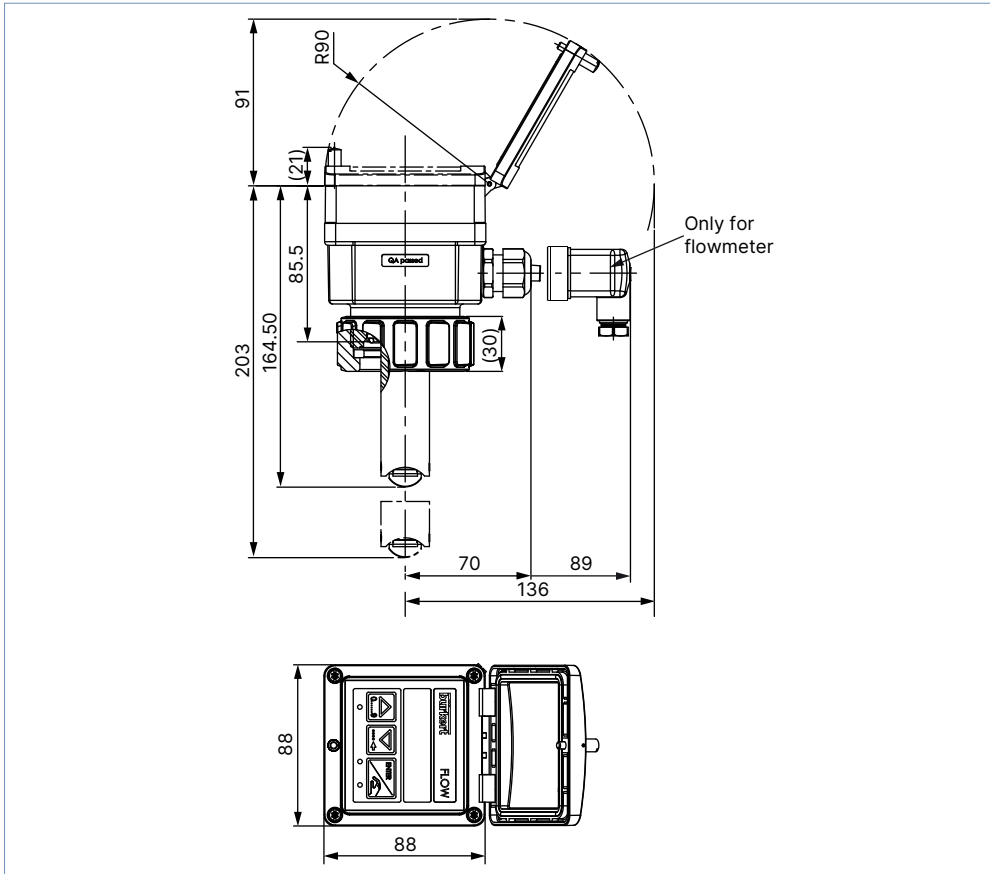

5.2. Flowmeter or compact batch controller installed in an Insertion fitting Type S020

Note:

Dimensions in mm, unless otherwise stated

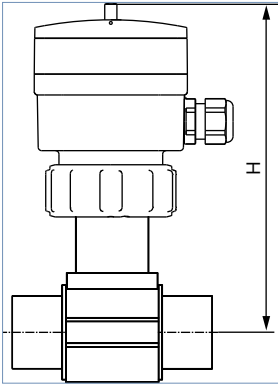

DN	H			
	T-Fitting	Saddle	Plastic spigot	Metal spigot
20	185	-	-	-
25	185	-	-	-
32	188	-	-	-
40	192	-	-	-
50	198	223	-	193
65	198	221	206	199
80	-	226	212	204
100	-	231	219	214
110	-	227	-	-
125	-	234	254	225
150	-	244	261	236
180	-	268	-	-
200	-	280	282	257
250	-	-	300	317
300	-	-	312	336
350	-	-	325	348
400	-	-	340	-

5.3. Flow transmitter or remote batch controller

Universal flow transmitter, panel variant

Note:

Dimensions in mm, unless otherwise stated

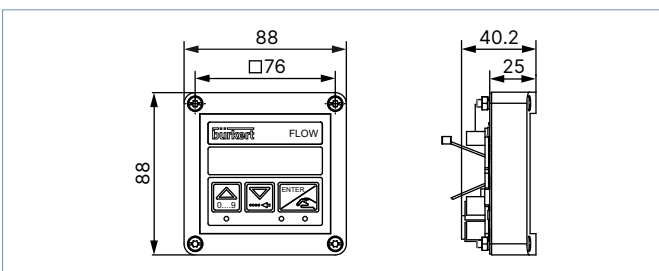

DTS 1000011079 EN Version: AH Status: RL (released | freigegeben | valide) printed: 24.03.2026

Universal flow transmitter, wall-mounted variant

Note:

Dimensions in mm, unless otherwise stated

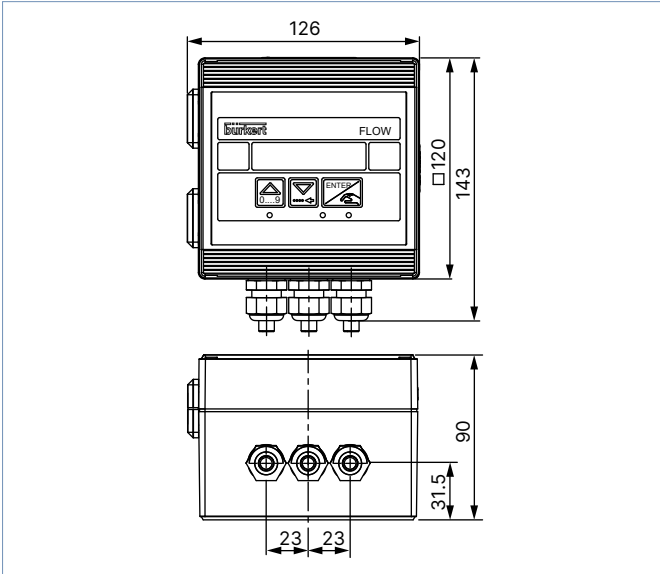

Flow transmitter for "Low Power" flowmeters, panel variant

Note:

Dimensions in mm, unless otherwise stated

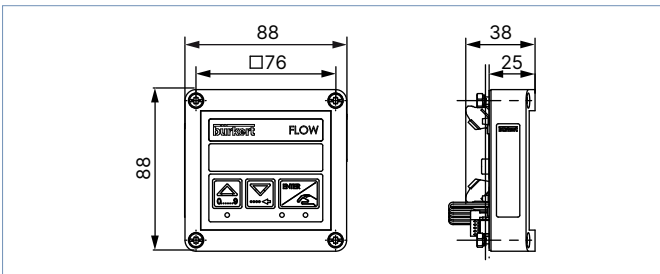

Flow transmitter for "Low Power" flowmeters, wall-mounted variant

Note:

Dimensions in mm, unless otherwise stated

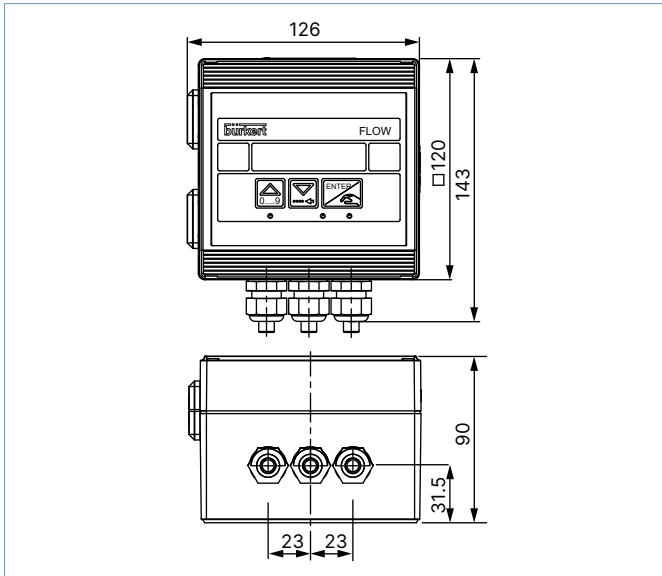

Remote batch controller, panel variant

Note:

Dimensions in mm, unless otherwise stated

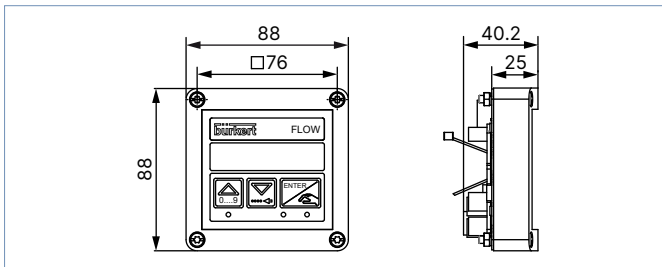

Remote batch controller, wall-mounted variant

Note:

Dimensions in mm, unless otherwise stated

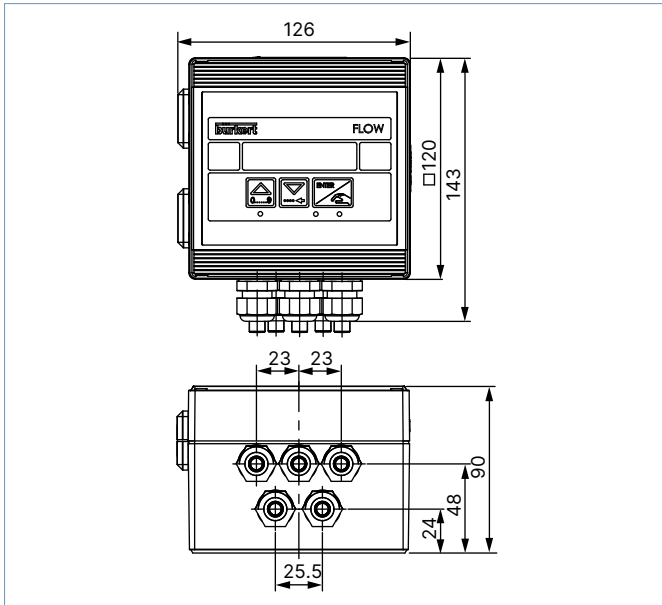

6. Performance specifications

6.1. Pressure temperature diagram

Note:

The following diagram applies only to the flowmeter or compact batch controller, with paddle-wheel.

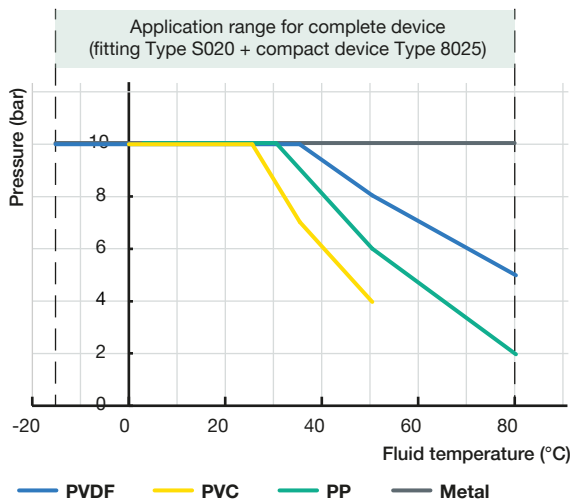

7. Product installation

7.1. Installation notes

Flow measurement

Note:

- The following installation instructions only apply to the flowmeter or compact batch controller, with paddle-wheel.
- The device is not suitable for use in gaseous media and steam.

Minimum straight distances upstream and downstream of the sensor must be observed. These stabilizing distances depend on the pipe's design. Increasing these distances or installing a flow conditioner may be necessary to obtain the best accuracy. For more information, refer to EN ISO 5167-1.

EN ISO 5167-1 specifies the straight inlet and outlet distances that must be complied with when installing fittings in pipe lines in order to achieve calm flow conditions. The most commonly used elements that could lead to turbulence in the flow are shown below. The related minimum inlet and outlet distances that ensure a calm flow are also specified.

Make sure that the measurement conditions at the point of measurement are calm and problem-free.

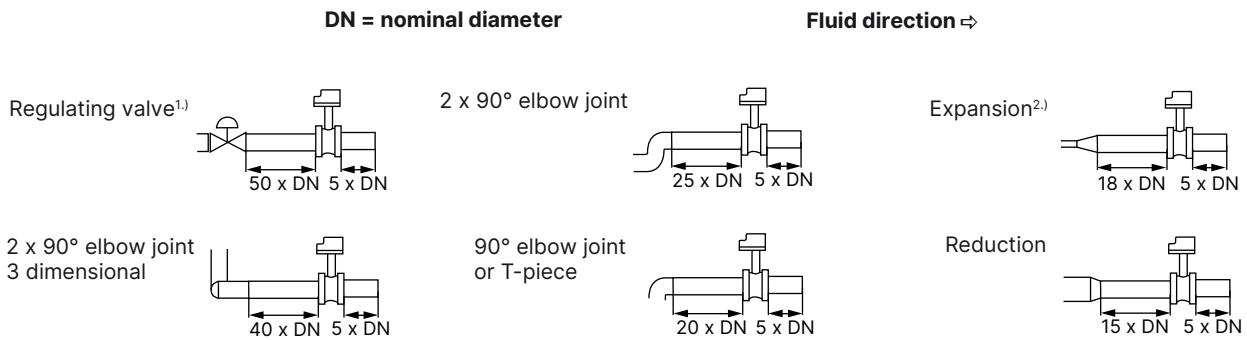

1.) If the valve cannot be mounted after the measuring device, the minimal distances have to be respected.
 2.) If an expansion cannot be avoided, the minimal distances have to be respected.
 Take the minimum flow velocity into account.

The device can be installed in either horizontal or vertical pipes, but following additional conditions should be respected:

- The pipe always has to be filled with fluid at all times near the device.
- The pipe design must be such that no air bubbles or cavitation can form within the medium near the device at any time.

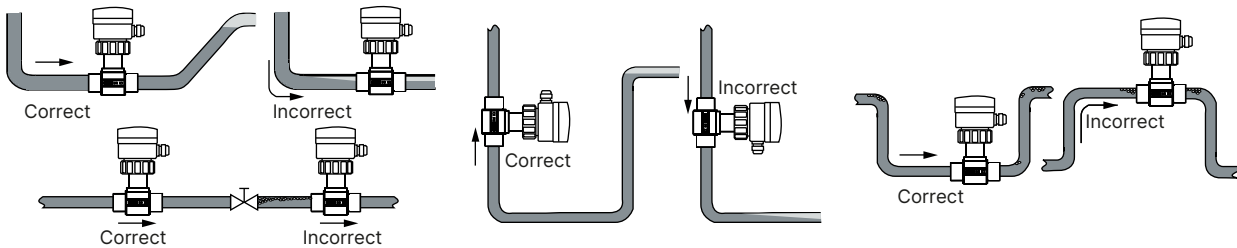

Pressure and temperature ratings must be respected according to the selected fitting material. The suitable pipe size is selected using the diagram in the chapter "Selection of the nominal diameter" of the **data sheet Type S020**.

DTS 1000011079 EN Version: AH Status: RL (released | freigegeben | valide) printed: 24.03.2026

8. Product operation

8.1. Measurement principle

Note:

The following measurement principles only apply to the flowmeter or compact batch controller, with paddle-wheel.

When liquid flows through the pipe, the paddle wheel with 4 inserted magnets is set in rotation, producing a measuring signal in the transducer (coil or Hall sensor depending on variant). The frequency of this signal is proportional to the flow velocity of the fluid.

A K factor, specific to each pipe, enables the conversion of this frequency into a flow rate/volume.

This K factor is available in the Insertion fittings' user manual, see **Type S020** ►.

Flowmeter:

The electronics converts the measured signal into several outputs (according to the device variant) and displays the actual value. The totalizers are used to obtain the volume of fluid that passed through the pipe.

The electrical connection for the flowmeter with standard output signal is provided via a cable plug according to DIN EN 175301-803 or on a terminal block via two cable glands (according to the flowmeter variant).

Batch controller:

The electronics component converts the measured signal and displays the actual value of the volume or mass. The electrical connection is provided on a terminal block via two cable glands.

8.2. Functional overview

Display and operating keys

Note:

The following functional overview uses a picture of a panel-mounted variant of the unit, but applies to all variants of Type 8025.

The display allows to:

- read the value of certain parameters e.g. for the flowmeter, the measured flow rate and the main totalizer
- set parameters of the device by means of 3 keys
- read the configuration of the device
- be warned of certain events.

Display and operating keys	No.	Description
	1	"Back" key: <ul style="list-style-type: none"> to increment the selected digit to go back to the previous function read the dosing history (only for batch controller)
	2	"Next" key: <ul style="list-style-type: none"> to select the character at the left to go to the next function to read messages (only with Insertion flowmeter as battery-powered indicator/totalizer and with batch controller)
	3	"Confirm" key: <ul style="list-style-type: none"> to confirm the displayed function to confirm the set parameters
	4	<ul style="list-style-type: none"> For Insertion flowmeter with standard output signal and for transmitter for "Low Power" flowmeters <ul style="list-style-type: none"> status LED of relay 2 For Universal transmitter and batch controller <ul style="list-style-type: none"> status LED of relay output DO3 (LED ON = contact closed)
	5	<ul style="list-style-type: none"> For Insertion flowmeter with standard output signal and for transmitter for "Low Power" flowmeters <ul style="list-style-type: none"> status LED of relay 1 For Universal transmitter and batch controller <ul style="list-style-type: none"> status LED of relay output DO2 (LED ON = contact closed)
	6	Device status: <ul style="list-style-type: none"> No status for Insertion flowmeter with standard output signal and for transmitter for "Low Power" flowmeters For Insertion flowmeter as a battery powered indicator/totalizer <ul style="list-style-type: none"> off: the device operates correctly. blinking orange: a warning message has been generated in the information menu. blinking red: an error message has been generated in the information menu. For Universal transmitter <ul style="list-style-type: none"> green: the device operates correctly. orange: a warning message has been generated in the information menu. red: an error message has been generated in the information menu and a 22 mA current is sent to the current output if activated. blinking, whatever the colour: a check for the correct behaviour of the output is running. The standard measurement function is inactive. For batch controller <ul style="list-style-type: none"> green: the device operates correctly. orange: an alarm related to the dosing and/or a warning message has been generated in the information menu. red: an error message has been generated in the information menu. blinking, whatever the colour: <ul style="list-style-type: none"> slowly blinking: the dosing has been interrupted. fast blinking during dosing: a dosing-related alarm has been generated. fast blinking when no dosing is being done: A remote query of the Information menu is currently in progress or the inputs/outputs are being checked for proper operation.

DTS 1000011079 EN Version: AH Status: RL (released | freigegeben | valide) printed: 24.03.2026

The device can be calibrated by means of the K factor (proportionality factor) of the fitting, or via the teach function. User adjustments, such as engineering units, output, filter settings and bar graph can be carried out directly on the device.

Operating levels

Flowmeter with standardized output signal or flow transmitter

The device has 2 operating levels:

- the process level
- the configuration level, which comprises the parameters and the test menus

Operating level	Functions
Process	This level allows: <ul style="list-style-type: none"> • to read: <ul style="list-style-type: none"> – the value of the measured flow – the value of the 4...20 mA output – the main totalizer value – the daily totalizer value • to reset the daily totalizer • to access the parameters and test menus of the configuration level
Configuration - parameters menu	This level allows: <ul style="list-style-type: none"> • to set the required operation parameters: <ul style="list-style-type: none"> – language – engineering units (international measurement units) – K factor/Teach function – 4...20 mA current output – pulse output – relay (on devices with relays) – filter (damping) – resetting both totalizers – Low Flow Cut Off (only for Universal transmitter) – brightness of the display (backlight, only for Universal transmitter)
Configuration - test menu	This level allows: <ul style="list-style-type: none"> • to adjust the Offset and Span of the 4...20 mA current output • to read the rotational frequency of the paddle wheel • to check the proper operation of the outputs with a simulated flow rate • to generate warning and fault messages (only for Universal transmitter)

DTS 1000011079 EN Version: AH Status: RL (released | freigegeben | valide) printed: 24.03.2026

Flowmeter as battery powered indicator/totalizer

The device has 2 operating levels:

- the process level
- the configuration level, which comprises the parameters, the test and the information menus

Operating level	Functions
Process	This level allows: <ul style="list-style-type: none"> • to read: <ul style="list-style-type: none"> – the value of the measured flow – the main totalizer value – the daily totalizer value • to reset the daily totalizer • to access the parameters, test and information menus of the configuration level
Configuration - parameters menu	This level allows: <ul style="list-style-type: none"> • to set the required operation parameters <ul style="list-style-type: none"> – language – engineering units (international measurement units) – K factor/Teach function – filter (damping) – resetting both totalizers
Configuration - test menu	This level allows: <ul style="list-style-type: none"> • to read the rotational frequency of the paddle wheel • to generate warning or error messages
Configuration - information menu	This level allows: <ul style="list-style-type: none"> • to read: <ul style="list-style-type: none"> – the battery charge status – the warning or error messages

DTS 1000011079 EN Version: AH Status: RL (released | freigegeben | valide) printed: 24.03.2026

Batch controller, compact or remote variants

The device has 2 operating levels:

- the process level
- the configuration level, which includes the parameters, the test, the information and the history menus

Operating level	Functions
Process	This level allows: <ul style="list-style-type: none"> • to start a dosing • to read: <ul style="list-style-type: none"> – the main totalizer value for the measured liquid quantity – the daily totalizer value for the measured liquid quantity – the main totalizer value of the performed dosings – the daily totalizer value of the performed dosings • to reset: <ul style="list-style-type: none"> – the daily volume or mass totalizer – the daily totalizer of the performed dosings • to access the parameters, test, information and history menus of the configuration level
Configuration - parameters menu	This level allows: <ul style="list-style-type: none"> • to set the required operation parameters <ul style="list-style-type: none"> – language – engineering units (international measurement units) – K factor/Teach function – dosing mode (optional) – overflow – alarm – outputs – resetting the 2 volume or mass totalizers – resetting the 2 totalizers of the performed dosings – resetting the history menu – backlight
Configuration - test menu	This level allows: <ul style="list-style-type: none"> • to check: <ul style="list-style-type: none"> – the inputs functions – the outputs functions – the paddle-wheel operation • to monitor: <ul style="list-style-type: none"> – the flow rate in the pipe – the value of the daily volume or mass totalizer – the number of performed dosings • to save/ restore: <ul style="list-style-type: none"> – the current user configuration – the saved configuration – the default configuration of the device
Configuration - history menu	This level allows the last 10 dosing quantities to be read.
Configuration - information menu	This level allows to read the fault or warning messages generated

DTS 1000011079 EN Version: AH Status: RL (released | freigegeben | valide) printed: 24.03.2026

8.3. Function modes

Flowmeter with standardized output signal

- 4...20 mA output + pulse
- 4...20 mA output + pulse + relay output
Hysteresis switching mode (both relays) for the output, inverted or not

Hysteresis mode

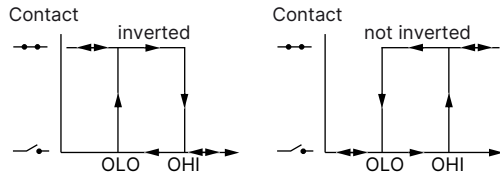

Batch controller, compact or remote variants

The following dosing modes are possible:

- **Locally started dosing of**
 - a **free quantity**: the user enters the quantity to be dosed and starts the dosing via the keypad.
 - a preset **quantity**: the user selects a preset quantity and starts the dosing via the keypad.
- **Dosing controlled by a PLC unit**: the user selects a preset quantity and starts the dosing using binary inputs.
- **Locally/remote selection of preset quantity and dosing controlled by a PLC unit**: the user selects a preset quantity and via the keypad or using binary inputs and starts the dosing using binary inputs.
- **Automatic dosing controlled by variation of pulse duration modulation**: the volume to be dosed is directly proportional to the pulse duration.
- **Locally/remote dosing determined by teach-in**:
 - teach-in of the dosing quantity via the keypad
 - teach-in of the dosing quantity using binary inputs.

9. Product design and assembly

9.1. Product assembly

Flowmeter or compact batch controller

Note:

- The device Type 8025 is installed into a Bürkert Insertion fitting Type S020 and fastened with a union nut.
- The Insertion fitting Type S020 ensures simple installation into pipes from DN 20...DN 400, see **data sheet Type S020** ▶ for more information.

The device with a paddle wheel sensor is available in long or short variant (depending on the DN of the used Insertion fitting). The sensor armature is mounted on the housing, which contains the electronic board with display and parameter keys.

The electrical connection is provided via a cable plug or two cable glands (variant with standard output signal) for the flowmeter and via two cable glands for the batch controller.

Compact flowmeter or compact batch controller with a G 2 process connection



Insertion fitting Type S020



Complete device for flow measurement or dosing Type 8025

Fitting in stainless steel (only example)

Flow transmitter or remote batch controller

Note:

The remote device Type 8025 is available in a wall-mounted or panel variant.

The panel-mounted variant is made up of an electronic module integrated in an open housing with display. The electrical connection is carried out on the terminal blocks of the electronic board.



The wall-mounted variant is made up of an electronic module integrated in a housing with cover and display. The electrical connection is carried out on the terminal blocks of the electronic board via three cable glands (for flow transmitter) or five cable glands (for batch controller).



10. Networking and combination with other Bürkert products

10.1. Networking and combination of the compact device

Flowmeter with standardized output signal

Example:



4...20 mA output	Pulse output	Relay output	
Type 8802 ▶ (2301 and 8693) ELEMENT Continuous control valve systems	Type 6212 ▶ Servo-assisted 2/2-way diaphragm valve	Type 6281 ▶ Servo-assisted 2/2-way diaphragm valve	Type S020 ▶ Insertion fitting for flow or analytical measurement

Compact batch controller

Example:

Type 8025	Type S020 ▶ Insertion fitting for flow or analytical measurement	Type 6212 ▶ Servo-assisted 2/2-way diaphragm valve	Type 6281 ▶ Servo-assisted 2/2-way diaphragm valve









10.2. Combination of the compact device with available nominal diameter (DN) of Type S020 fittings

		DN20	DN50	DN65	DN100	DN200	DN350	DN400
Available S020 fittings DN	T-Fitting	short sensor						
	Welding socket		short sensor			long sensor		
	Fusion spigot			short sensor		long sensor		
	Screw-on spigot					long sensor		
	Saddle		long sensor					

10.3. Combination of the remote device

Note:

Connection possibilities according to the flow meter variant

							
		Universal transmitter		Transmitter for "Low Power" flowmeters		Remote batch controller	
		Panel-mounted	Wall-mounted	Panel-mounted	Wall-mounted	Panel-mounted	Wall-mounted
	Hall variant (short or long) Frequency output with pulse signal (NPN, PNP, open collector)	Yes	Yes	No	No	Yes	Yes
	Hall „Low Power“ variant (short or long) Frequency output with pulse signal (NPN, open collector)	Yes	Yes	Yes	Yes	Yes	Yes
Type 8020 ▶ Insertion flowmeter							
	Hall variant Frequency output with pulse signal (NPN, PNP, open collector)	Yes	Yes	No	No	Yes	Yes
	Hall „Low Power“ variant Frequency output with pulse signal (NPN, open collector)	Yes	Yes	Yes	Yes	Yes	Yes
Type 8030 (SE30 + S030) ▶ or Type SE30+S077 ▶ Inline flowmeter							
	Frequency output with pulse signal (NPN, PNP, open collector)	Yes	Yes	No	No	Yes	Yes
Type 8030 HT ▶ Inline flowmeter for high temperatures							
	–	Yes	Yes	No	No	Yes	Yes
Type SE30 Ex + (S030 or S077) ▶ Inline flowmeter for hazardous areas							
	Frequency output with pulse signal (NPN)	Yes	Yes	No	No	Yes	Yes
Type 8031 ▶ Flow sensor for low-flow measurement							
	Frequency output with pulse signal (NPN)	Yes	Yes ¹⁾	No	No	Yes	Yes ¹⁾
Type 8041 ▶ Insertion electromagnetic flowmeter							
	Frequency output with pulse signal (NPN)	Yes	Yes	No	No	Yes	Yes
Type 8071 ▶ or Type 8077 ▶ Flow sensor with oval gears							

1.) Except device with Article no. 419543

DTS 1000011079 EN Version: AH Status: RL (released | freigegeben | valide) printed: 24.03.2026

11. Ordering information

11.1. Bürkert eShop



Bürkert eShop – Easy ordering and quick delivery

You want to find your desired Bürkert product or spare part quickly and order directly? Our online shop is available for you 24/7. Sign up and enjoy all the benefits.

[Order online now](#)

11.2. Recommendation regarding product selection

Compact flowmeter or compact batch controller

A compact and complete flow measurement or batch control equipment consists of a compact flowmeter or batch controller Type 8025 and a Bürkert Insertion fitting Type S020.

See [data sheet Type S020](#) ▶ for more information.

Two different components must be ordered to obtain a complete device. The following information is required:

- **Article no.** of the compact flowmeter or batch controller Type 8025 (see chapter [“Flowmeter” on page 36](#) or [“Compact batch controller” on page 37](#))
- **Article no.** of the Type S020 Insertion fitting (see [data sheet Type S020](#) ▶)

Universal flow transmitter

This transmitter Type 8025 (wall-mounted or panel-mounted variant) has to be connected to Bürkert flowmeters or to any other compatible flowmeter of a third-party provider.

Two different components must be ordered to obtain a complete device. The following information is required:

- **Article no.** of the Type 8025 Universal transmitter (see chapter [“Universal transmitter” on page 37](#))
- **Article no.** of the Bürkert flowmeter (see chapter [“10.3. Combination of the remote device” on page 34](#) and also the corresponding data sheet)

Flow transmitter for “Low Power” flowmeters

This transmitter Type 8025 (wall-mounted or panel-mounted variant) has to be connected **only** to Bürkert “Low Power” flowmeters, i.e:

- a Bürkert Type 8020 flowmeter “Low Power” variant associated to an Insertion fitting Type S020 or
- a Type SE30 flow transmitter “Low Power” variant associated to an Inline sensor-fitting. The Inline sensor-fitting can be either Type S030 (SE30+S030 = Type 8030) or Type S077.

Three different components must be ordered to obtain a complete device. The following information is required:

- **Article no.** of the Type 8025 transmitter for “Low Power” flowmeters (see chapter [“Flow transmitter for “Low Power” flowmeters” on page 37](#))
- **Article no.** of the Bürkert Type 8020 flowmeter or Type SE30 flow transmitter (pulse “Low Power” variant) (see chapter [“10.3. Combination of the remote device” on page 34](#) and also [data sheet Type 8020](#) ▶ or [data sheet Type 8030](#) ▶)
- **Article no.** of the Bürkert Insertion fitting Type S020 (DN 20...DN 400) or Bürkert Inline sensor-fitting Type S030 (DN 06...DN 65) or Inline sensor-fitting Type S077 (DN 15...DN 100) (see [data sheet Type S020](#) ▶, [data sheet Type S030](#) ▶ or [data sheet Type S077](#) ▶).

Remote batch controller

This batch controller Type 8025 (wall-mounted or panel-mounted variant) has to be connected to Bürkert flowmeters or to any other compatible flowmeter of a third-party provider.

Two different components must be ordered to obtain a complete device. The following information is required:

- **Article no.** of the remote Type 8025 batch controller (see chapter **“Remote batch controller” on page 38**)
- **Article no.** of the Bürkert flowmeter (see chapter **“10.3. Combination of the remote device” on page 34** and also the corresponding data sheet) or others

11.3. Bürkert product filter

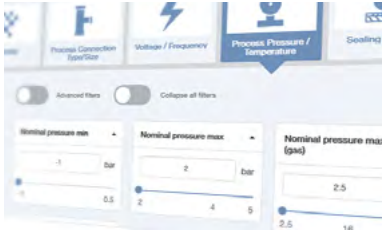

Bürkert product filter – Get quickly to the right product

You want to select products comfortably based on your technical requirements? Use the Bürkert product filter and find suitable articles for your application quickly and easily.

[Try out our product filter](#)

11.4. Ordering chart

Flowmeter

Note:

- The following is supplied with every device: FKM seal as standard (already mounted), 1 set with a black EPDM seal for the sensor, a stopper for unused M20 × 1.5 cable gland, a 2 × 6 mm multi-way seal for cable gland and a mounting instruction sheet.
- The following variants have at least 2 volume totalizers.

Operating voltage	Sensor variant	Output	UL approval	Electrical connection	Article no.
Flowmeter with standard output signal					
12...36 V DC	Hall, short	4...20 mA (2-wire) + pulse	–	Female cable plug	418762
			UL Recognized	DIN EN 175301-803	570457
			–	2 cable glands	418802
			UL Recognized		570465
	Hall, long	4...20 mA (2-wire) + pulse	–	Female cable plug	418763
			UL Recognized	DIN EN 175301-803	570458
			–	2 cable glands	418803
			UL Recognized		570466
Hall, short	4...20 mA (3-wire) + pulse + 2 relays	–		418778	
		UL Recognized		570461	
		–		418779	
		UL Recognized		570462	
115/230 V AC	Hall, short	4...20 mA (2-wire) + pulse	–		418423
	Hall, long				418424
	Hall, short	4...20 mA (3-wire) + pulse + 2 relays			418431
	Hall, long				418432
Flowmeter as battery powered indicator/totalizer					
4 × 1.5 V DC AA Batteries	Coil, short	None	–	None	418403
	Coil, long				418405

Further variants on request









Approval
 FDA, UL Recognized for USA and Canada (UL 61010-1 + CAN/CSA-C22.2 No. 61010-1)

DTS 1000011079 EN Version: AH Status: RL (released | freigegeben | valide) printed: 24.03.2026

Compact batch controller

Note:









- The following is supplied with every device: FKM seal as standard (already mounted), 1 set with a black EPDM seal for the sensor, a stopper for unused M20 × 1.5 cable gland, a 2 × 6 mm multi-way seal for cable gland and a mounting instruction sheet.
- The following variants have at least 2 volume or mass totalizers and 2 totalizers of the number of dosing performed.

Operating voltage	Sensor variant	Input	Output	UL approval	Electrical connection	Article no.
12...36 V DC	Hall, short	4 digital inputs (DI1...DI4)	2 transistor outputs (DO1 and DO4) + 2 relay outputs (DO2 and DO3)	-	2 cable glands	419520 
				UL Recognized		564414 
	-			419522 		
	UL Recognized			570469 		
115/230 V AC	Hall, short			-		419521 
	Hall, long					419529 

Universal transmitter

Note:







- Sensor variant: Types 8020, 8030 (SE30+S030), SE30+S077, 8041, 8071, 8077... (see chapter "10.3. Combination of the remote device" on page 34).
- The following variants have at least 2 volume totalizers.

Operating voltage	Output	UL approval	Electrical connection	Article no.
Panel mounted variant				
12...36 V DC	1current output 4...20 mA (AO1, 3-wire) + 1 pulse output (DO1)	-	Terminal strip	419538 
		UL Recognized		564416 
	1current output 4...20 mA (AO1, 3-wire) + 1 pulse output (DO1) + 2 relay outputs (DO2 and DO3)	-		419537 
		UL Recognized		564417 
Wall-mounted variant				
12...36 V DC	1current output 4...20 mA (AO1, 3-wire) + 1 pulse output (DO1)	-	3 cable glands	419541 
	1current output 4...20 mA (AO1, 3-wire) + 1 pulse output (DO1) + 2 relay outputs (DO2 and DO3)			419540 
115/230 V AC	1current output 4...20 mA (AO1, 3-wire) + 1 pulse output (DO1)			419544 
	1current output 4...20 mA (AO1, 3-wire) + 1 pulse output (DO1) + 2 relay outputs (DO2 and DO3)			419543 

Flow transmitter for "Low Power" flowmeters

Note:





- Sensor variant: only Types 8020, 8030 and SE30+S077 in "Low Power" variant (see chapter "10.3. Combination of the remote device" on page 34).
- The following variants have at least 2 volume totalizers.

Operating voltage	Output	UL approval	Electrical connection	Article no.
Panel mounted variant				
12...36 V DC	4...20 mA (2-wire) + pulse	-	Terminal strip	418992 
		UL Recognized		552725 
	4...20 mA (3-wire) + pulse + 2 relays	-		418994 
		UL Recognized		552726 
Wall-mounted variant				
12...36 V DC	4...20 mA (2-wire) + pulse	-	3 cable glands	418397 
	4...20 mA (3-wires) + pulse + 2 relays			418396 
115/230 V AC	4...20 mA (2-wire) + pulse			418400 
	4...20 mA (3-wire) + pulse + 2 relays			418399 

Remote batch controller









Note:

- Sensor variant: Types 8020, 8030 (SE30+S030), SE30+S077, 8041, 8071, 8077... (see chapter "10.3. Combination of the remote device" on page 34.
- The following variants have at least 2 volume or mass totalizers and 2 totalizers of the number of dosing performed.



Operating voltage	Input	Output	UL approval	Electrical connection	Article no.
Panel mounted variant					
12...36 V DC	4 digital inputs (DI1...DI4)	2 transistor outputs (DO1 and DO4) + 2 relay outputs (DO2 and DO3)	–	Terminal strip	419536 
			UL Recognized		564415 
Wall-mounted variant					
12...36 V DC	4 digital inputs (DI1...DI4)	2 transistor outputs (DO1 et DO4) + 2 relay outputs (DO2 et DO3)	–	5 cable glands	433740 
115/230 V AC					433741 

11.5. Ordering chart accessories

Accessories for compact device

Description	Article no.
For flowmeter or compact batch controller	
Set with two cable glands M20 × 1.5, two neoprene flat seals for cable gland or plug, two screw plugs M20 × 1.5 and two multi-way seals 2 × 6 mm	449755 
Set with two adapters M20 × 1.5 /NPT ½, two neoprene flat seals for cable gland or plug and two screw plugs M20 × 1.5	551782 
Set with a stopper for unused cable gland M20 × 1.5, a multi-way seal 2 × 6 mm for cable gland, a black EPDM seal for the sensor and a mounting instruction sheet	551775 
Set with a green FKM seal and a black EPDM seal	552111 
Fastening ring (open) for Type S020 Insertion fitting	619205 
PC union nut for Type S020 Insertion fitting	619204 
For flowmeter	
Female cable plug, 4-pin (3 conductors + protective conductor), form A according to DIN EN 175301-803 with cable gland (Type 2518 ▶)	572264 
Female cable plug 32 mm, 4-pin (3 conductors + protective conductor), form A according to DIN EN 175301-803, with NPT ½ reduction without cable gland (Type 2509 ▶)	162673 
For batch controller	
Set with 8 FLOW front panel films	553191 

Accessories for remote device

Description	Article no.
For flowmeter or remote batch controller, panel variant	
Mounting set (screws, spring lock washers, hexagon nuts, cable clips)	554807 
Flat seal	419350 
Set with 8 FLOW front panel films	553191 
For flowmeter or remote batch controller, wall-mounted variant	
Power supply board 115/230 V AC + mounting instruction sheet	555722 