



Insertion flowmeter or batch controller with paddle wheel and flow transmitter or remote batch controller

- Up to PN 10, measurement tube size DN 06 to DN 400
- Display for showing the flow rate and volume with two totalisers, or dosing
- Automatic calibration via teach-in
- Inputs (with batch controller) and all outputs can be checked without the need for actual flow
- Overall total and daily total for batch quantity and number of batches, volume or mass totalisers displayed (with batch controller)

Product variants described in the data sheet may differ from the product presentation and description.

Can be combined with

- 
Type 8611
eCONTROL – Universal controller
▶
- 
Type 8619
multiCELL – multi-channel/
multi-function transmitter/
controller
▶
- 
Type 8802
ELEMENT continuous control
valve systems – overview
▶
- 
Type 8644
AirLINE SP electropneumatic
automation system
▶

Type description

Device Type 8025 is specially designed for use in neutral or mildly aggressive, particle-free liquids. The device is supplied as a flowmeter or batch controller, in a compact variant with paddle wheel sensor or in a remote variant.

Bürkert's proprietary fitting system permits simple installation of the compact device into pipelines from DN 20 to DN 400. The compact flowmeter is available with a standard signal output or without output (battery-operated display/totaliser).

Remote devices (flow transmitters or batch controllers) intended for wall mounting or fitting inside a control cabinet must either be connected to a Bürkert flowmeter Type 8020, Type 8031, Type 8041 or Type SE30+S077, or to a flowmeter with open collector output, reed relay output, TTL, CMOS or solenoid.

DTS 1000011079 EN Version: AF Status: RL (released | freigegeben | validé) printed: 13.01.2025

Table of contents

1. General technical data	4
1.1. About the device.....	4
1.2. Flowmeter or compact batch controller	4
General data	4
Flowmeter	6
Compact batch controller	7
1.3. Flow transmitter or remote batch controller	9
General data	9
Universal flow transmitter	10
Flow transmitter for "Low Power" flowmeters.....	12
Remote batch controller	13
2. Product versions	14
2.1. Flowmeter	14
2.2. Compact batch controller	15
2.3. Universal flow transmitter	15
2.4. Flow transmitter for "Low Power" flowmeters.....	15
2.5. Remote batch controller	16
3. Approvals and conformities	17
3.1. General notes	17
3.2. Conformity	17
3.3. Standards.....	17
3.4. Pressure Equipment Directive (PED)	17
Device used on a pipe.....	17
3.5. North America (USA/Canada)	17
4. Materials	18
4.1. Bürkert resistApp	18
4.2. Material specifications	18
Flowmeter or compact batch controller	18
Flow transmitter or remote batch controller, panel variant	19
Flow transmitter or remote batch controller, wall-mounted variant	19
5. Dimensions	20
5.1. Flowmeter or compact batch controller	20
5.2. Flowmeter or compact batch controller installed in an Insertion fitting Type S020.....	21
5.3. Flow transmitter or remote batch controller	21
Universal flow transmitter, panel variant	21
Universal flow transmitter, wall-mounted variant	22
Flow transmitter for "Low Power" flowmeters, panel variant.....	22
Flow transmitter for "Low Power" flowmeters, wall-mounted variant.....	23
Remote batch controller, panel variant	23
Remote batch controller, wall-mounted variant.....	24
6. Performance specifications	24
6.1. Pressure temperature diagram	24
7. Product installation	25
7.1. Installation notes.....	25
Flow measurement.....	25
8. Product operation	26

8.1.	Measuring principle	26
	Flowmeter:	26
	Batch controller:.....	26
8.2.	Functional overview	26
	Display and operating keys.....	26
	Flowmeter with standard output signal or flow transmitter.....	28
	Flowmeter as battery powered indicator/totalizer.....	29
	Batch controller, compact or remote variants	30
8.3.	Function modes	31
	Flowmeter with standard output signal.....	31
	Batch controller, compact or remote variants	31
9.	Product design and assembly	32
9.1.	Product assembly	32
	Flowmeter or compact batch controller	32
	Flow transmitter or remote batch controller	32
10.	Networking and combination with other Bürkert products	33
10.1.	Networking and combination of the compact device.....	33
	Flowmeter with standard output signal.....	33
	Compact batch controller	33
10.2.	Combination of the compact device with available Type S020 Insertion fittings DN.....	33
10.3.	Combination of the remote device.....	34
11.	Ordering information	35
11.1.	Bürkert eShop	35
11.2.	Recommendation regarding product selection.....	35
	Compact flowmeter or compact batch controller	35
	Universal flow transmitter	35
	Flow transmitter for "Low Power" flowmeters.....	35
	Remote batch controller	36
11.3.	Bürkert product filter.....	36
11.4.	Ordering chart	36
	Flowmeter	36
	Compact batch controller	37
	Universal transmitter.....	37
	Flow transmitter for "Low Power" flowmeters.....	37
	Remote batch controller.....	38
11.5.	Ordering chart accessories.....	38
	Accessories for compact device.....	38
	Accessories for remote device.....	38e

DTS 1000011079 EN Version: AF Status: RL (released | freigegeben | valide) printed: 13.01.2025

1. General technical data

1.1. About the device

The device Type 8025 is available in a compact variant as a flowmeter or as a batch controller or in a remote variant (wall-mounted or panel-mounted) as a flow transmitter or as a batch controller.



Furthermore, the compact flowmeter is available either as a measuring device with standard output signal or as a battery powered indicator/totalizer.

In addition, the flow transmitter is available in two variants: a Universal variant and a variant for Bürkert "Low Power" flowmeters.

1.2. Flowmeter or compact batch controller

General data

The following data are valid for both the flowmeter and the batch controller.

Product properties

Material

Make sure the device materials are compatible with the fluid you are using.
Further information can be found in chapter ["4.1. Bürkert resistApp" on page 18.](#)

Further information on the materials can be found in chapter ["4.2. Material specifications" on page 18.](#)

Non wetted parts

Lid	PC
Front panel film	Polyester
Cover	PC
Housing	PC
Screw	Stainless steel
Union nut	PC
Seal	NBR
Female cable plug/male fixed plug	<ul style="list-style-type: none"> Body, contact holder and cable gland in PA Cable gland seal and flat seal in NBR
Cable gland	PA

Wetted parts

Sensor armature	PVDF
Axis and bearing	Ceramics (Al ₂ O ₃)
Paddle wheel	PVDF
Seal	FKM standard (EPDM included, but not mounted)

Display	15 × 60 mm, 8-digit LCD, alphanumeric, 15 segments, 9 mm high
Compatibility	Any pipe from DN 20 ¹⁾ ...DN 400 which is fitted with Bürkert Type S020 Insertion fitting. For the selection of the nominal diameter of the fittings, see data sheet Type S020 ►.
Pipe diameter	DN 20 ¹⁾ ...DN 400
Dimensions	Further information can be found in chapter "5. Dimensions" on page 20.
Measuring principle	Paddle wheel
Measuring range	<ul style="list-style-type: none"> Flow rate: 0.5...75000 l/min Flow velocity: 0.3...10 m/s

Performance data	
Measurement deviation	<ul style="list-style-type: none"> Teach-in: $\pm 1\%$ of the measured value^{2,1)} at teach flow rate value Standard K factor: $\pm 2.5\%$ of the measured value¹⁾
Linearity	$\pm 0.5\%$ of full scale ²⁾
Repeatability	$\pm 0.4\%$ of the measured value ²⁾
Electrical data	
Power source (not supplied)	Limited power source according to UL/EN 62368-1 standards or limited energy circuit according to UL/EN 61010-1 paragraph 9.4
DC reverse polarity protection	Yes
Overvoltage protection	Yes
Voltage supply cable	<ul style="list-style-type: none"> Cable with maximum operating temperature greater than 80 °C (176 °F) (90 °C (194 °F) for UL-Recognized variant) Max. 50 m length, shielded
Medium data	
Fluid temperature	With fitting Type S020 in: <ul style="list-style-type: none"> PVC: 0...+ 50 °C (+ 32...+ 122 °F) PP: 0...+ 80 °C (+ 32...+ 176 °F) PVDF, stainless steel or brass: - 15...+ 80 °C (+ 5...+ 176 °F) (up to + 100 °C (212 °F) for flowmeter with batteries) See data sheet Type S020 ► for more information.
Fluid pressure	Max. PN 10 See data sheet Type S020 ► for more information.
Viscosity	Max. 300 cSt
Rate of solid particles	Max. 1%
Maximum particle size	0.5 mm
Process/Pipe connection & communication	
Process connection	G 2" for use with Type S020 Insertion fitting See data sheet Type S020 ► for more information.
Approvals and conformities	
Directives	
CE directive	Further information on the CE directive can be found in chapter " 3.3. Standards " on page 17.
Pressure equipment directive	Complying with article 4, paragraph 1 of 2014/68/EU directive Further information on the pressure equipment directive can be found in chapter " 3.4. Pressure Equipment Directive (PED) " on page 17.
North America (USA/Canada)	UL Recognized for the USA and Canada
Environment and installation	
Relative air humidity	$\leq 80\%$, without condensation
Height above sea level	Max. 2000 m
Operating condition	Continuous
Equipment mobility	Fixed
Application range	Indoor and outdoor Protect the device against electromagnetic interference, ultraviolet rays and, when installed outdoors, against the effects of climatic conditions.
Degree of protection ^{3,1)} according to IEC/EN 60529	IP65 with the following conditions met: <ul style="list-style-type: none"> device wired cover and lid screwed tight female cable plug or glands mounted and tightened with blind plug on unused cable glands
Installation category	Category I according to UL/EN 61010-1
Pollution degree	Degree 2 according to UL/EN 61010-1

1.) Restricted to some Insertion fitting process connections

2.) Under reference conditions i.e. measuring medium = water, ambient and water temperature = + 20 °C (+ 68 °F), observing the minimum the minimum inlet and outlet sections and the appropriate inner diameter of the pipe.

3.) Not evaluated by UL

Flowmeter

Note:

If the device is mounted in a humid environment or outside, then the maximum voltage allowed is **35 V DC** instead of 36 V DC.

Performance data

4...20 mA output uncertainty ± 1% of current range

Electrical data

Operating voltage (V+)	<p>Measuring device with standard output signal</p> <ul style="list-style-type: none"> 12...36 V DC ± 10%, filtered and regulated Connection to main supply: permanent, through external SELV (Safety Extra Low Voltage) and LPS (Limited Power Source) power supply 115/230 V AC, 50/60 Hz Voltage supply available inside the device: <ul style="list-style-type: none"> supplied voltage: 27 V DC regulated maximum current: 125 mA integrated protection: 125 mA time delay fuse <p>Battery powered indicator/totalizer</p> <ul style="list-style-type: none"> 4 × 1.5 V DC non-rechargeable alkaline AA batteries, lifetime 4 years at 20 °C (68 °F)
Current consumption	<p>12...36 V DC powered measuring device with standard output signal, with sensor and without pulse output consumption</p> <ul style="list-style-type: none"> With relays: ≤ 70 mA Without relay: ≤ 25 mA
Power consumption	115/230 V AC powered measuring device: 3 VA
Output	<p>Measuring device with standard output signal</p> <ul style="list-style-type: none"> Transistor (pulse): <ul style="list-style-type: none"> potential free NPN or PNP (wiring dependant) function: pulse output, adjustable pulse value 0...400 Hz 5...36 V DC, 100 mA, voltage drop at 100 mA: 2.5 V DC duty cycle (pulse duration/period): 0.5 galvanic insulation and protected against overvoltage, polarity reversals and short circuit Relay: <ul style="list-style-type: none"> 2 relays, normally open, hysteresis, adjustable thresholds non UL recognized device: 230 V AC/3 A or 40 V DC/3 A (resistive load) UL recognized device: 30 V AC/42 V_{peak}/3 A or 60 V DC/1 A Current: <ul style="list-style-type: none"> 4...20 mA (3-wire with relays, 2-wire without relay) sourcing or sinking (wiring dependant) max. loop impedance: 900 Ω at 30 V DC, 600 Ω at 24 V DC, 50 Ω at 12 V DC, 800 Ω with a 115/230 V AC voltage supply response time (10...90 %) for the measured value: 6 s (default) <p>Battery powered indicator/totalizer</p> <ul style="list-style-type: none"> Without output

Voltage supply cable	Measuring device with standard output signal <ul style="list-style-type: none"> External diameter (cable): <ul style="list-style-type: none"> 5...8 mm (with cable plug) 6...12 mm (1 cable per cable gland) or 3...5 mm when using a multi-way seal (2 cables per cable gland) Cross section of wires: <ul style="list-style-type: none"> 0.25...1.5 mm² (with cable plug) 0.75 mm² (with cable gland) Cross section of the local ground wire: max. 0.75 mm²
	Battery powered indicator/totalizer <ul style="list-style-type: none"> None

Process/Pipe connection & communication

Electrical connection	<ul style="list-style-type: none"> Variant 12...36 V DC: cable plug or cable glands M20 × 1.5 Variant with batteries: None
-----------------------	--

Environment and installation

Ambient temperature	Operation and storage: <ul style="list-style-type: none"> variant 12...36 V DC: -10...+60 °C (+5...+140 °F) variant 115/230 V AC: -10...+50 °C (+5...+122 °F) variant with batteries: -10...+55 °C (+5...+131 °F)
---------------------	--

Compact batch controller

Note:

If the device is mounted in a humid environment or outside, then the maximum voltage allowed is **35 V DC** instead of 36 V DC.

Electrical data

Operating voltage (V+)	<ul style="list-style-type: none"> 12...36 V DC, max tolerance: -5 % or +10 % at 12 V DC, ±10 % at 36 V DC, filtered and regulated Connection to main supply: permanent, through external SELV (Safety Extra Low Voltage) and LPS (Limited Power Source) power supply 115/230 V AC, 50/60 Hz Voltage supply available inside the device: <ul style="list-style-type: none"> supplied voltage: 27 V DC regulated maximum current: 125 mA integrated protection: 125 mA time delay fuse
Current consumption	With sensor, without consumption of digital input and pulse output <ul style="list-style-type: none"> With relays: <ul style="list-style-type: none"> ≤ 100 mA (at 12 V DC) ≤ 50 mA (at 36 V DC) ≤ 55 mA (115/230 V AC) Without relay: <ul style="list-style-type: none"> ≤ 70 mA (at 12 V DC) ≤ 35 mA (at 36 V DC) ≤ 40 mA (115/230 V AC)
Power consumption	115/230 V AC powered measuring device: 3 VA
Input	<ul style="list-style-type: none"> DI (1 to 4) Switching threshold V_{on}: 5...36 V DC Switching threshold V_{off} max.: 2 V DC Min. pulse duration: 100 ms Input impedance: 9.4 kΩ Galvanic insulation, protected against polarity reversals and voltage spike

Output	<ul style="list-style-type: none"> • Transistors (digital outputs DO1 and DO4): <ul style="list-style-type: none"> – potential-free – NPN or PNP (wiring dependant) – function: pulse output (by default for DO1), batch state (by default for DO4), configurable and parametrizable – 0...300 Hz – 5...36 V DC, 100 mA max., voltage drop at 100 mA: 2.7 V DC – duty cycle (pulse duration/period): > 0.45 – galvanic insulation, protected against overvoltage, polarity reversals and short-circuits • Relays (digital outputs DO2 and DO3): <ul style="list-style-type: none"> – 2 relays, normally open, parametrizable (by default: DO2 always configured to control the valve, parametrized of 100 % of the batch quantity and DO3 configured as alarm) – non UL recognized device: 230 V AC/3 A or 40 V DC/3 A (resistive load) – UL recognized device: 30 V AC/42 V_{peak}/3 A or 60 V DC/1 A – max. cutting power of 750 VA (resistive load)
--------	--

Voltage supply cable	<ul style="list-style-type: none"> • External diameter (cable): <ul style="list-style-type: none"> – 6...12 mm (1 cable per cable gland) or – 4 mm when using a multi-way seal (2 cables per cable gland) • Cross section of wires: 0.75 mm²
----------------------	--

Process/Pipe connection & communication

Electrical connection	Cable glands M20 × 1.5
-----------------------	------------------------

Environment and installation

Ambient temperature	<p>Operation and storage:</p> <ul style="list-style-type: none"> • variant 12...36 V DC: -10...+ 60 °C (+ 5...+ 140 °F) • variant 115/230 V AC: -10...+ 50 °C (+ 5...+ 122 °F)
---------------------	--

DTS 1000011079 EN Version: AF Status: RL (released | freigegeben | validé) printed: 13.01.2025

1.3. Flow transmitter or remote batch controller

General data

The following data are valid for the universal flow transmitter, for the flow transmitter for "Low Power" flowmeters as well as for the remote batch controller.

Product properties

Material

Make sure the device materials are compatible with the fluid you are using.

Further information can be found in chapter "4.1. Bürkert resistApp" on page 18.

Further information on the materials can be found in chapter "4.2. Material specifications" on page 18.

Non wetted parts

Front panel film	Polyester
Cover	ABS (wall-mounted variant)
Housing	<ul style="list-style-type: none"> • PC (panel-mounted variant) • ABS (wall-mounted variant)
Screw	Stainless steel
Seal	NBR
Cable gland	PA (wall-mounted variant)
Cable clamp	PA (panel-mounted variant)
Display	15 × 60 mm, 8-digit LCD, alphanumeric, 15 segments, 9 mm high
Dimensions	Further information can be found in chapter "5. Dimensions" on page 20.

Electrical data

Power source (not supplied)	Limited power source according to UL/EN 62368-1 standards or limited energy circuit according to UL/EN 61010-1 paragraph 9.4
DC reverse polarity protection	Yes
Overvoltage protection	Yes
Voltage supply cable	<ul style="list-style-type: none"> • Cable with maximum operating temperature greater than 80 °C (90 °C for UL Recognized variant) • Max. 50 m length • Cross section of wires: 0.2...1.5 mm²

Process/Pipe connection & communication

Electrical connection	<ul style="list-style-type: none"> • Panel-mounted variant: terminals • Wall-mounted variant: terminals via gland M16 × 1.5
-----------------------	---

Approvals and conformities

Directives

CE directive	Further information on the CE directive can be found in chapter "3.3. Standards" on page 17.
North America (USA/Canada)	UL Recognized for US and Canada

Environment and installation

Ambient temperature	Operation and storage: - 10...+ 60 °C (+ 14...+ 140 °F)
Relative air humidity	≤ 80 %, without condensation
Height above sea level	Max. 2000 m
Operating condition	Continuous
Equipment mobility	Fixed
Application range	Indoor and outdoor Protect the device against electromagnetic interference, ultraviolet rays and, when installed outdoors, against the effects of climatic conditions.
Degree of protection ¹⁾ according to EN 60529	<ul style="list-style-type: none"> • Panel-mounted variant: <ul style="list-style-type: none"> – front side: IP65 installation completed and closed cabinet – rear side: IP20 inside the closed cabinet • Wall-mounted variant: <ul style="list-style-type: none"> – IP65 with the following conditions met: <ul style="list-style-type: none"> – device wired – cover screwed tight – female cable plug or glands mounted and tightened – with blind plug on unused cable glands

1.) Not evaluated by UL

Universal flow transmitter

Note:

If the device is mounted in a humid environment or outside, then the maximum voltage allowed is **35 V DC** instead of 36 V DC.

Product properties	
Compatibility	Bürkert flowmeter with frequency output (Types 8020, 8030, 8030HT, 8041, 8031, SE30+S077, 8071, 8077) or other sensors with compatible electrical data
Performance data	
4...20 mA output uncertainty	± 1 % of current range
Electrical data	
Operating voltage (V+)	<ul style="list-style-type: none"> • Panel-mounted variant: <ul style="list-style-type: none"> – 12...36 V DC, max tolerance: - 5 % or + 10 % at 12 V DC, ± 10 % at 36 V DC, filtered and regulated Connection to main supply: permanent, through external SELV (Safety Extra Low Voltage) and LPS (Limited Power Source) power supply • Wall-mounted variant: <ul style="list-style-type: none"> – 12...36 V DC, max tolerance: - 5 % or + 10 % at 12 V DC, ± 10 % at 36 V DC, filtered and regulated Connection to main supply: permanent, through external SELV (Safety Extra Low Voltage) and LPS (Limited Power Source) power supply – 115/230 V AC, 50/60 Hz Voltage supply available inside the device: <ul style="list-style-type: none"> – supplied voltage: 27 V DC regulated – maximum current: 250 mA – integrated protection: 250 mA time delay fuse
Current consumption	Without sensor and without consumption of 4...20 mA output of the flowmeter <ul style="list-style-type: none"> • With relays: <ul style="list-style-type: none"> – ≤ 70 mA (at 12 V DC) – ≤ 45 mA (at 36 V DC) – ≤ 50 mA (115/230 V AC, wall-mounted variant) • Without relay: <ul style="list-style-type: none"> – ≤ 50 mA (at 12 V DC) – ≤ 30 mA (at 36 V DC) – ≤ 35 mA (115/230 V AC, wall-mounted variant)
Power consumption	115/230 V AC powered measuring device: 6 VA
Device input (from sensor)	<ul style="list-style-type: none"> • Frequency range: 0.6 Hz...2.2 kHz, can be adjusted • Voltage: max. 36 V DC • Type of the signal: <ul style="list-style-type: none"> – pulse: open collector NPN (with 470 Ω or 2.2 kΩ resistance) or PNP, TTL, CMOS (with 39 kΩ resistance) – sine-wave, coil (with 39 kΩ resistance and with minimum sensitivity of 50 mV peak to peak)
Device output (to sensor)	<ul style="list-style-type: none"> • Voltage supply with a powered 12...36 V DC transmitter: <ul style="list-style-type: none"> – 10.5...34.5 V DC [= (V+) - 1.5 V DC], 140 mA max. – 0...23.5 V DC [= (V+) - 12.5 V DC], 80 mA max. – 5 V DC, 30 mA max. • Voltage supply with a powered 115/230 V AC transmitter: <ul style="list-style-type: none"> – + 27 V DC, 80 mA max. – + 14.5 V DC [= (V+) - 12.5 V DC] 80 mA max. – 5 V DC, 30 mA max.

Output	<ul style="list-style-type: none"> • Transistor (digital output DO1): <ul style="list-style-type: none"> – potential free – NPN or PNP (wiring dependant) – function: pulse output, adjustable pulse value – 0...2200 Hz – 5...36 V DC, 100 mA max., voltage drop at 100 mA: 2.7 V DC – duty cycle (pulse duration/period): <ul style="list-style-type: none"> – > 0.45 if 0.6 < frequency < 300 Hz – > 0.4 if 300 < frequency < 1500 Hz – < 0.4 if 1500 < frequency < 2200 Hz – galvanic insulation, protected against overvoltage, polarity reversals and short-circuit • Relays (digital outputs DO2 and DO3): <ul style="list-style-type: none"> – 2 relays, normally open, hysteresis, adjustable thresholds – non UL recognized device: 230 V AC/3 A or 40 V DC/3 A (resistive load) – UL recognized device: 30 V AC/42 V_{peak}/3 A or 60 V DC/1 A – max. cutting power of 750 VA (resistive load) – life span of min. 100 000 cycles • Current (analogue output AO1): <ul style="list-style-type: none"> – 4...20 mA (3-wire) – sourcing or sinking (wiring dependant) – 22 mA to indicate a fault (can be activated) – max. loop impedance: 1300 Ω at 36 V DC, 1000 Ω at 30 V DC, 750 Ω at 24 V DC, 300 Ω at 15 V DC, 200 Ω at 12 V DC, 900 Ω with a 115/230 V AC voltage supply
Voltage supply cable	<ul style="list-style-type: none"> • Wall-mounted variant: <ul style="list-style-type: none"> – external diameter (cable): 4...8 mm (for the cable glands)

Flow transmitter for "Low Power" flowmeters
Note:

If the device is mounted in a humid environment or outside, then the maximum voltage allowed is **35 V DC** instead of 36 V DC.

Product properties	
Compatibility	Bürkert flowmeter with frequency output (Types 8020, 8030, SE30+S077) in "Low Power" pulse signal variant
Performance data	
4...20 mA output uncertainty	± 1 % of current range
Electrical data	
Operating voltage (V+)	<ul style="list-style-type: none"> • Panel-mounted variant: <ul style="list-style-type: none"> – 12...36 V DC ± 10 %, filtered and regulated Connection to main supply: permanent, through external SELV (Safety Extra Low Voltage) and LPS (Limited Power Source) power supply • Wall-mounted variant: <ul style="list-style-type: none"> – 12...36 V DC ± 10 %, filtered and regulated Connection to main supply: permanent, through external SELV (Safety Extra Low Voltage) and LPS (Limited Power Source) power supply – 115/230 V AC, 50/60 Hz Voltage supply available inside the device: <ul style="list-style-type: none"> – supplied voltage: 27 V DC regulated – maximum current: 250 mA – integrated protection: 250 mA time delay fuse
Current consumption	With sensor and without pulse output consumption <ul style="list-style-type: none"> • With relays: ≤ 70 mA • Without relay: ≤ 25 mA
Power consumption	115/230 V AC powered measuring device: 6 VA
Device input (from sensor)	<ul style="list-style-type: none"> • Frequency range: 2.5...400 Hz • Pulse signal (Hall): "Low Power", NPN Open Collector
Device output (to sensor)	Voltage supply 10...34 V DC [= (V+) - 2 V DC], 1 mA max.
Output	<ul style="list-style-type: none"> • Transistor (pulse): <ul style="list-style-type: none"> – potential free – NPN or PNP (wiring dependant) – function: pulse output, adjustable pulse value – 0...400 Hz – 5...36 V DC, 100 mA, voltage drop at 100 mA: 2.5 V DC – duty cycle (pulse duration/period): 0.5 – galvanic insulation and protected against overvoltage, polarity reversals and short circuit • Relay: <ul style="list-style-type: none"> – 2 relays, normally open, hysteresis, adjustable thresholds – non UL recognized device: 230 V AC/3 A or 40 V DC/3 A (resistive load) – UL recognized device: 30 V AC/42 V_{peak}/3 A or 60 V DC/1 A • Current: <ul style="list-style-type: none"> – 4...20 mA (3-wire with relays, 2-wire without relay) – sourcing or sinking (wiring dependant) – max. loop impedance: 900 Ω at 30 V DC, 600 Ω at 24 V DC, 50 Ω at 12 V DC, 800 Ω with a 115/230 V AC voltage supply – response time (10...90 % for the measured value: 6 s (default)
Voltage supply cable	<ul style="list-style-type: none"> • Wall-mounted variant: <ul style="list-style-type: none"> – external diameter (cable): 4...8 mm (for the cable glands)

Remote batch controller

Note:

If the device is mounted in a humid environment or outside, then the maximum voltage allowed is **35 V DC** instead of 36 V DC.

Product properties	
Compatibility	Bürkert flow sensor with frequency output (Types 8020, 8030, 8030HT, 8041, 8031, 8070, 8071, 8077) or other sensors with compatible electrical data
Electrical data	
Operating voltage (V+)	<ul style="list-style-type: none"> 12...36 V DC, max tolerance: - 5 % or + 10 % at 12 V DC, ± 10 % at 36 V DC, filtered and regulated Connection to main supply: permanent, through external SELV (Safety Extra Low Voltage) and LPS (Limited Power Source) power supply 115/230 V AC, 50/60 Hz Voltage supply available inside the device: <ul style="list-style-type: none"> – supplied voltage: 27 V DC regulated – maximum current: 250 mA – integrated protection: 250 mA time delay fuse
Current consumption	With sensor and without consumption of 4...20 mA output of the flowmeter <ul style="list-style-type: none"> • With relays: <ul style="list-style-type: none"> – ≤ 70 mA (at 12 V DC) – ≤ 45 mA (at 36 V DC) – ≤ 50 mA (115/230 V AC, wall-mounted variant) • Without relay: <ul style="list-style-type: none"> – ≤ 50 mA (at 12 V DC) – ≤ 30 mA (at 36 V DC) – ≤ 35 mA (115/230 V AC, wall-mounted variant)
Power consumption	115/230 V AC powered measuring device: 6 VA
Device input (from sensor)	<ul style="list-style-type: none"> • Frequency range: 0.6 Hz...2.2 kHz • Voltage: Max. 36 V DC • Type of the signal: <ul style="list-style-type: none"> – pulse: open collector NPN (with 470 Ω or 2.2 kΩ resistance) or PNP, TTL, CMOS (with 39 kΩ resistance) – sine-wave: coil (with 39 kΩ resistance)
Device output (to sensor)	<ul style="list-style-type: none"> • Voltage supply with a powered 12...36 V DC transmitter: <ul style="list-style-type: none"> – 10.5...34.5 V DC [= (V+) - 1.5 V DC], 140 mA max. – 0...23.5 V DC [= (V+) - 12.5 V DC], 80 mA max. – 5 V DC, 30 mA max. • Voltage supply with a powered 115/230 V AC transmitter: <ul style="list-style-type: none"> – + 27 V DC, 80 mA max. – + 14.5 V DC [= (V+) - 12.5 V DC] 80 mA max. – 5 V DC, 30 mA max.
Input	<ul style="list-style-type: none"> • DI (1 to 4) • Switching threshold V_{on}: 5...36 V DC • Switching threshold V_{off} max.: 2 V DC • Min. pulse duration: 100 ms • Input impedance: 9.4 kΩ • Galvanic insulation, protected against polarity reversals and voltage spike

Output	<ul style="list-style-type: none"> • Transistors (digital outputs DO1 and DO4): <ul style="list-style-type: none"> – potential free – NPN or PNP (wiring dependent) – function: pulse output (by default for DO1), state (by default for DO4), configurable and parametrizable – 0...2200 Hz, – 5...36 V DC, 100 mA max., voltage drop at 100 mA: 2.7 V DC – duty cycle (pulse duration/period): <ul style="list-style-type: none"> – > 0.45 if 0.6 < frequency < 300 Hz – > 0.4 if 300 < frequency < 1500 Hz – < 0.4 if 1500 < frequency < 2200 Hz – galvanic insulation, protected against overvoltage, polarity reversals and short-circuits • Relays (digital outputs DO2 and DO3): <ul style="list-style-type: none"> – 2 relays, normally open, parametrizable (by default: DO2 always configured to control the valve, parametrised of 100 % of the batch quantity and DO3 configured as alarm) – non UL recognized device: 230 V AC/3 A or 40 V DC/3 A (resistive load) – UL recognized device: 30 V AC/42 V_{peak}/3 A or 60 V DC/1 A – max. cutting power of 750 VA (resistive load)
Voltage supply cable	<ul style="list-style-type: none"> • Wall-mounted variant: <ul style="list-style-type: none"> – external diameter (cable): 5...8 mm (for the cable glands)

2. Product versions

2.1. Flowmeter

The compact variant is available in two variants:

- Insertion flowmeter with standard output signal (4...20 mA, frequency)
- Insertion flowmeter as battery powered indicator/totalizer



Flowmeter with standard output signal

The device operates on a 2- or 3-wire system and needs a 12...36 V DC or a 115/230 V AC power supply.

The device is equipped with:

- an analogue output (4...20 mA current output)
- a digital output (pulse output) and
- two totalizers.

Some variants are also fitted with two fully configurable relay outputs.

The device allows:

- through the digital or relay outputs
 - to switch a solenoid valve
 - to activate an alarm
 - to generate a flow rate proportional frequency
- through the analogue output to establish a control loop.



Flowmeter as battery powered indicator/totalizer

The device has no output and displays the instantaneous value as well as the amount of liquid that has flowed through.

2.2. Compact batch controller



The device needs a voltage supply of 12...36 V DC or 115/230 V AC.

The device is equipped with:

- four digital inputs (DI1 to DI4),
- two transistor outputs (DO1 configured as a pulse output and DO4 configured as state output, by default),
- two relay outputs (DO2 always configured to control the valve and by default parametrise of 100% of the batch quantity and DO3 configured as alarm output by default),
- two volume or mass totalizers and two totalizers for the number of batches performed.

The second relay output can be used to activate another valve, to initiate alarms or to generate warnings.

When mounted in a pipe in series with one or two valves, the batch controller makes it possible to carry out a dosing of one or several quantities of liquids. The unit controls the opening of the valves and measures the quantity of the fluid which flows. The unit also closes the valves when the pre-set quantity has been delivered.

2.3. Universal flow transmitter



The transmitter is available in wall-mounted and panel variants.

The transmitter can be associated with Bürkert flowmeter (e.g. Type 8020, 8030, SE30+S077). See chapter ["10.3. Combination of the remote device"](#) on page 34 for more information. Another flow sensor emitting a frequency signal (pulse signal) can also be connected.

The transmitter operates on a 3-wire system and needs a 12...36 V DC or a 115/230 V AC power supply.

The transmitter is equipped with:

- an analogue output (4...20 mA current output, called AO1)
- a digital output (configured as a pulse output by default, called DO1)
- two totalizers.

Some variants are also fitted with two fully configurable relay outputs (called DO2 and DO3).

When connected to a flowmeter, the transmitter allows:

- through the digital or relay outputs
 - to switch a solenoid valve
 - to activate an alarm
 - to generate a flow rate proportional frequency
- through the analogue output to establish a control loop.

2.4. Flow transmitter for "Low Power" flowmeters



The transmitter is available in wall-mounted and panel variants.

The transmitter variant can only be associated with Bürkert flowmeter (e.g. Type 8020, 8030, SE30+S077) with sinus or pulse output signal **in a "Low Power" variant**. See chapter ["10.3. Combination of the remote device"](#) on page 34 for more information.

The transmitter operates on a 2- or 3-wire system and needs a 12...36 V DC or a 115/230 V AC power supply.

The device is equipped with:

- an analogue output (4...20 mA current output)
- a digital output (pulse output)
- two totalizers.

Some variants are also fitted with two fully configurable relay outputs.

When connected to a flowmeter, the transmitter allows:

- through the digital or relay outputs
 - to switch a solenoid valve
 - to activate an alarm
 - to generate a flow rate proportional frequency
- through the analogue output to establish a control loop.

2.5. Remote batch controller



The device is available in wall-mounted and panel variants.

The device can be associated with Bürkert flowmeters (e.g. Type 8020, 8030, SE30+S077). See chapter **“10.3. Combination of the remote device” on page 34** for more information. Another flow sensor emitting a frequency signal (pulse signal) can also be connected.



The device needs a voltage supply of 12...36 V DC or 115/230 V AC.

The device is equipped with:

- four digital inputs (DI1 to DI4),
- two transistor outputs (DO1 configured as a pulse output and DO4 configured as state output, by default),
- two relay outputs (DO2 always configured to control the valve and by default parametrise of 100% of the batch quantity and DO3 configured as alarm output by default),
- two volume or mass totalizers and two totalizers for the number of batches performed.

The second relay output can be used to activate another valve, to initiate alarms or to generate warnings.

When the batch controller is connected to a flowmeter in series with one or two valves, dosing of one or several quantities of liquids can be carried out. The device controls the opening of the valves and measures the quantity of the fluid which flows. The device also closes the valves when the pre-set quantity has been delivered.

3. Approvals and conformities

3.1. General notes

- The approvals and conformities listed below must be stated when making enquiries. This is the only way to ensure that the product complies with all required specifications.
- Not all available variants can be supplied with the below mentioned approvals or conformities.

3.2. Conformity

In accordance with the Declaration of Conformity, the product is compliant with the EU Directives.

3.3. Standards

The applied standards which are used to demonstrate compliance with the EU Directives are listed in the EU-Type Examination Certificate and/or the EU Declaration of Conformity.

3.4. Pressure Equipment Directive (PED)

The device conforms to Article 4, Paragraph 1 of the Pressure Equipment Directive 2014/68/EU under the following conditions:

Device used on a pipe

Note:

- The data in the table is independent of the chemical compatibility of the material and the fluid.
- PS = maximum admissible pressure, DN = nominal diameter of the pipe

Type of fluid	Conditions
Fluid group 1, Article 4, Paragraph 1.c.i	DN ≤ 25
Fluid group 2, Article 4, Paragraph 1.c.i	DN ≤ 32 or PS*DN ≤ 1000
Fluid group 1, Article 4, Paragraph 1.c.ii	DN ≤ 25 or PS*DN ≤ 2000
Fluid group 2, Article 4, Paragraph 1.c.ii	DN ≤ 200 or PS ≤ 10 or PS*DN ≤ 5000

3.5. North America (USA/Canada)

Approval	Description
	Optional: UL Recognized for the USA and Canada The products are UL Recognized for the USA and Canada according to: <ul style="list-style-type: none"> • UL 61010-1 (ELECTRICAL EQUIPMENT FOR MEASUREMENT, CONTROL, AND LABORATORY USE – Part 1: General Requirements) • CAN/CSA-C22.2 No. 61010-1

4. Materials

4.1. Bürkert resistApp



Bürkert resistApp – Chemical resistance chart

You want to ensure the reliability and durability of the materials in your individual application case? Verify your combination of media and materials on our website or in our resistApp.

[Start chemical resistance check](#)

4.2. Material specifications

Flowmeter or compact batch controller

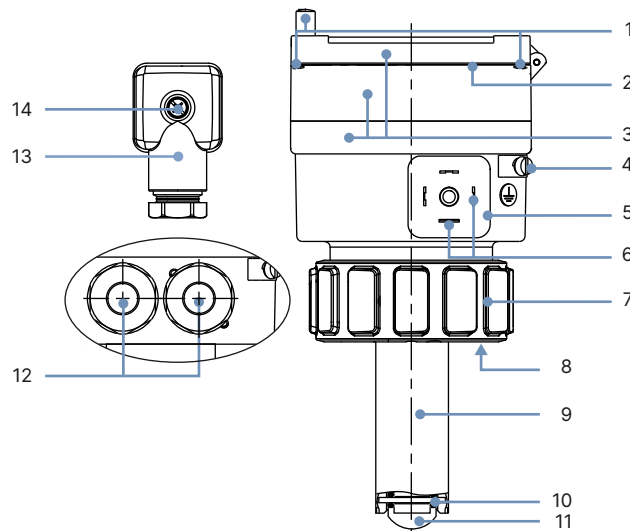

No.	Element	Material
1	Screws	Stainless steel
2	Front panel foil	Polyester
3	Housing, cover, lid	PC
4	Screw	Stainless steel
5	Male fixed plug (DIN EN 175301-803)	PA
6	Electrical contact	Sn
7	Nut	PC
8	Seal	FKM (EPDM included, but not mounted)
9	Sensor armature	PVDF
10	Axis and bearing	Ceramics (Al ₂ O ₃)
11	Paddle wheel	PVDF
12	M20 × 1.5 cable gland	PA
13	Female cable plug (DIN EN 175301-803)	<ul style="list-style-type: none"> Body, contact holder and cable gland in PA Cable gland seal and flat seal in NBR
14	Screw	Stainless steel

DTS 1000011079 EN Version: AF Status: RL (released | freigegeben | valide) printed: 13.01.2025

Flow transmitter or remote batch controller, panel variant

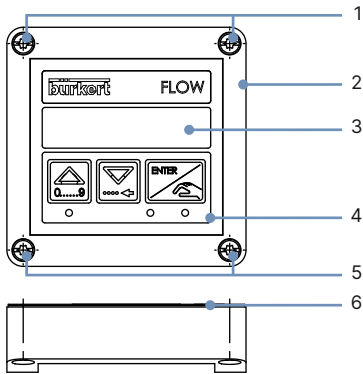

No.	Element	Material
1	Screws	Stainless steel
2	Housing	PC
3	Window	PPMA
4	Front panel foil	Polyester
5	Screws	Stainless steel
6	Seal	NBR
-	Cable clip (at the back of the housing)	PA

Flow transmitter or remote batch controller, wall-mounted variant

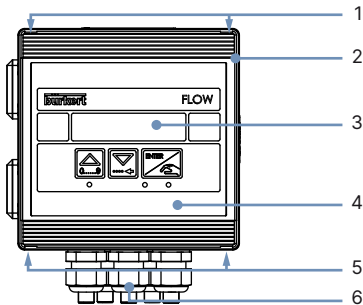

No.	Element	Material
1	Screws (under the cover plate)	Stainless steel
2	Housing and cover	ABS
3	Window	PPMA
4	Front panel foil	Polyester
5	Screws (under the cover plate)	Stainless steel
6	Cable glands	PA
-	Seal (between housing and cover)	NBR

5. Dimensions

5.1. Flowmeter or compact batch controller

Note:

- Dimensions in mm, unless otherwise stated
- The length of the flow probe depends on the used Insertion fitting Type S020 and its nominal diameter, see **data sheet Type S020** ▶ for more information.

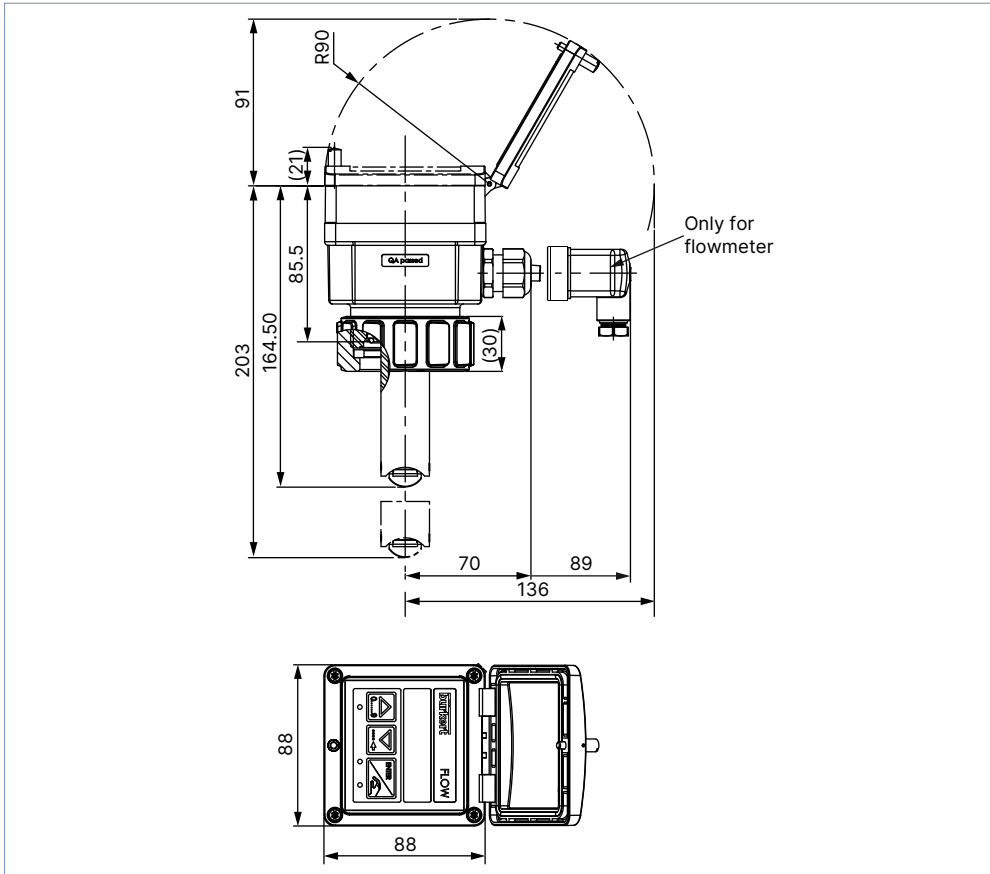

5.2. Flowmeter or compact batch controller installed in an Insertion fitting Type S020

Note:

Dimensions in mm, unless otherwise stated

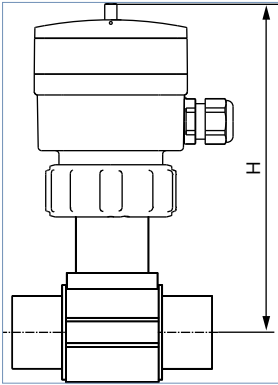

DN	H			
	T-Fitting	Saddle	Plastic spigot	Metal spigot
20	185	-	-	-
25	185	-	-	-
32	188	-	-	-
40	192	-	-	-
50	198	223	-	193
65	198	221	206	199
80	-	226	212	204
100	-	231	219	214
110	-	227	-	-
125	-	234	254	225
150	-	244	261	236
180	-	268	-	-
200	-	280	282	257
250	-	-	300	317
300	-	-	312	336
350	-	-	325	348
400	-	-	340	-

5.3. Flow transmitter or remote batch controller

Universal flow transmitter, panel variant

Note:

Dimensions in mm, unless otherwise stated

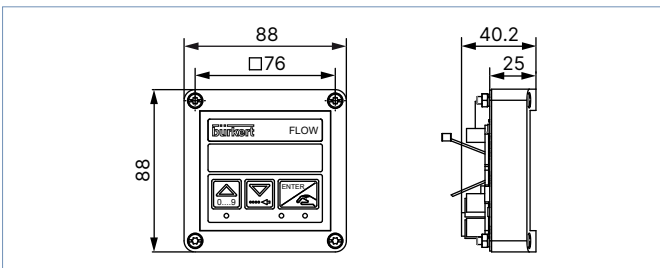

DTS 1000011079 EN Version: AF Status: RL (released | freigegeben | valide) printed: 13.01.2025

Universal flow transmitter, wall-mounted variant

Note:

Dimensions in mm, unless otherwise stated

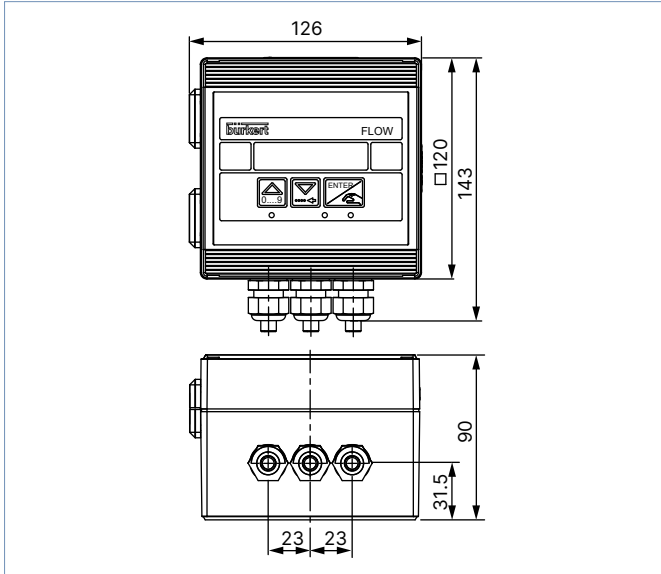

Flow transmitter for "Low Power" flowmeters, panel variant

Note:

Dimensions in mm, unless otherwise stated

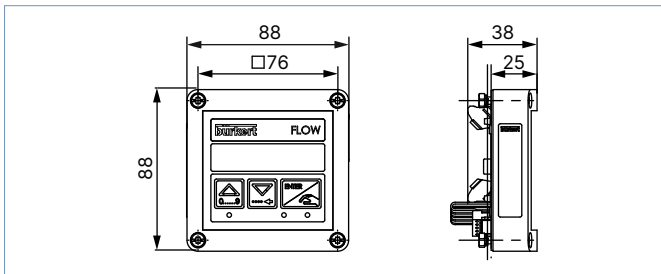

Flow transmitter for "Low Power" flowmeters, wall-mounted variant

Note:

Dimensions in mm, unless otherwise stated

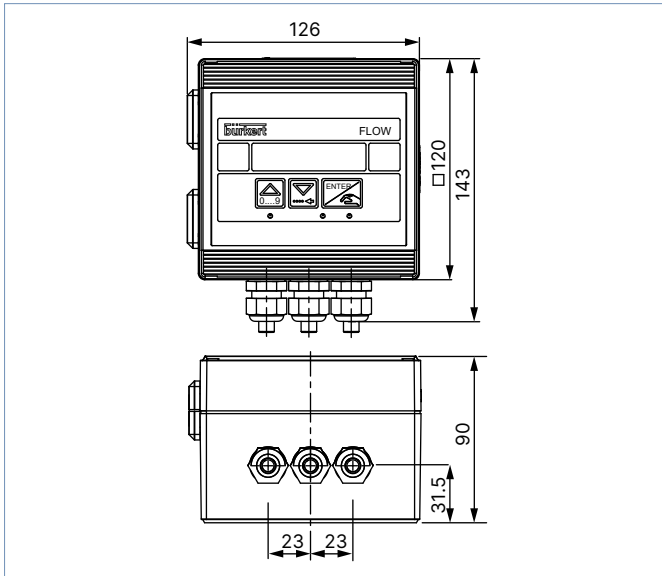

Remote batch controller, panel variant

Note:

Dimensions in mm, unless otherwise stated

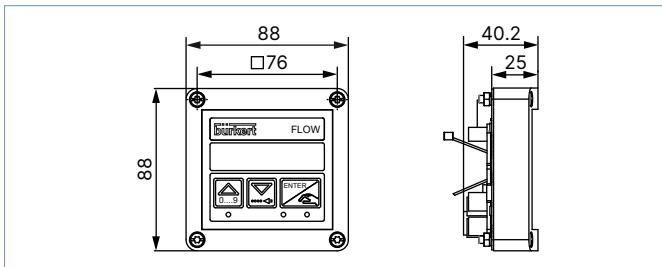

Remote batch controller, wall-mounted variant

Note:

Dimensions in mm, unless otherwise stated

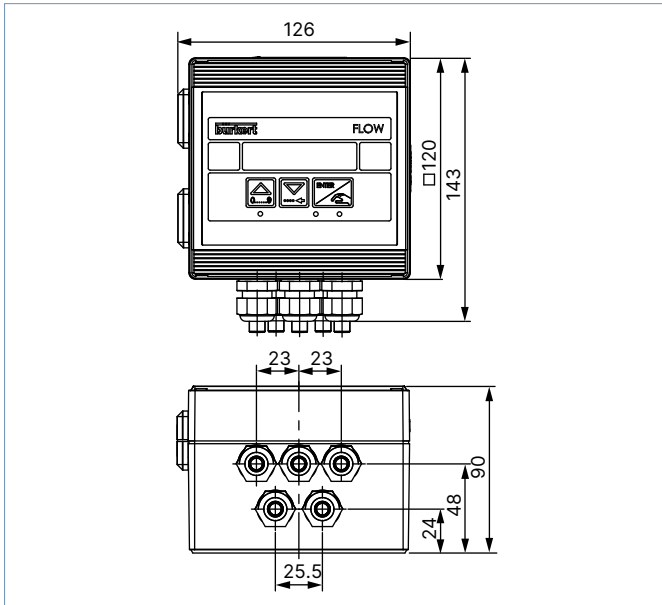

6. Performance specifications

6.1. Pressure temperature diagram

Note:

The following diagram applies only to the flowmeter or compact batch controller, with paddle-wheel.

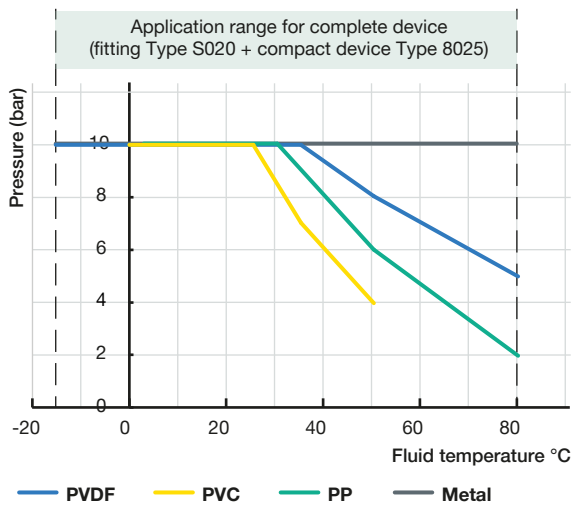

7. Product installation

7.1. Installation notes

Flow measurement

Note:

- The following installation instructions only apply to the flowmeter or compact batch controller, with paddle-wheel.
- The device is not suitable for use in gaseous media and steam.

Minimum straight distances upstream and downstream of the sensor must be observed. These stabilizing distances depend on the pipe's design. Increasing these distances or installing a flow conditioner may be necessary to obtain the best accuracy. For more information, refer to EN ISO 5167-1.

EN ISO 5167-1 specifies the straight inlet and outlet distances that must be complied with when installing fittings in pipe lines in order to achieve calm flow conditions. The most commonly used elements that could lead to turbulence in the flow are shown below. The related minimum inlet and outlet distances that ensure a calm flow are also specified.

Make sure that the measuring conditions at the point of measurement are calm and problem-free.

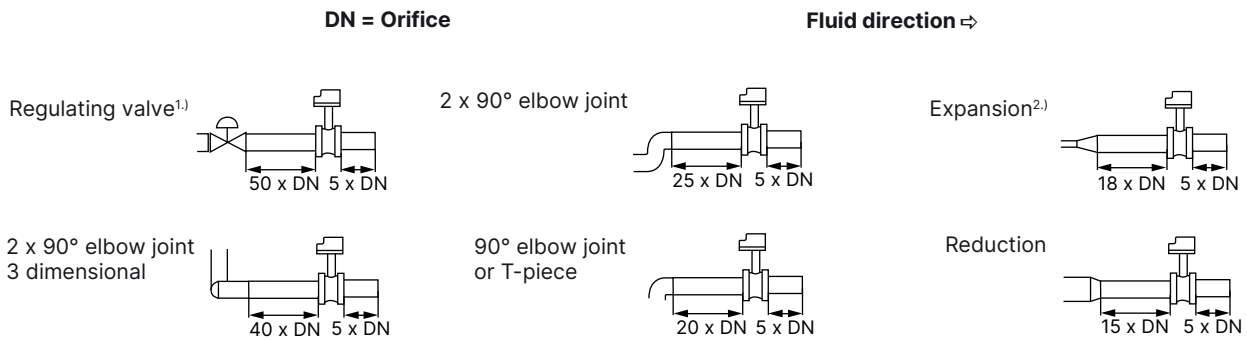

1.) If the valve cannot be mounted after the measuring device, the minimal distances have to be respected.
 2.) If an expansion cannot be avoided, the minimal distances have to be respected.
 Please note minimum flow velocity

The device can be installed in either horizontal or vertical pipes, but following additional conditions should be respected:

- The pipe always has to be filled with fluid at all times near the device.
- The pipe design must be such that no air bubbles or cavitation can form within the medium near the device at any time.

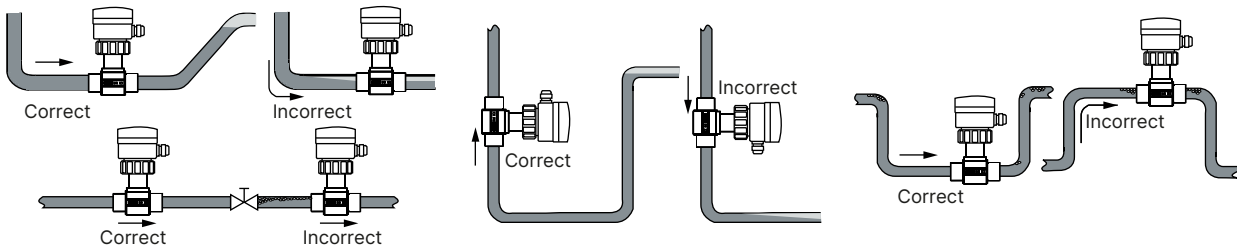

Pressure and temperature ratings must be respected according to the selected fitting material. The suitable pipe size is selected using the diagram in the chapter "Nominal size selection" of the **data sheet Type S020** ▶.

DTS 1000011079 EN Version: AF Status: RL (released | freigegeben | validé) printed: 13.01.2025

8. Product operation

8.1. Measuring principle

Note:

The following measuring principles only apply to the flowmeter or compact batch controller, with paddle-wheel.

When liquid flows through the pipe, the paddle wheel with 4 inserted magnets is set in rotation, producing a measuring signal in the sensor (coil or Hall sensor depending on variant). The frequency modulated induced voltage is proportional to the flow velocity of the fluid.

A K factor, specific to each pipe, enables the conversion of this frequency into a flow rate/volume.

This K factor is available in the fittings' operating instructions, see **Type S020** ▶.

Flowmeter:

The electronic component converts the measured signal into several outputs (according to the device variant) and displays the actual value. Totalizers are used to obtain the volume of fluid passed through the pipe.

The electrical connection for the flowmeter with standard output signal is provided via a cable plug according to DIN EN 175301-803 or two cable glands (according to the flowmeter variant).

Batch controller:

The electronic component converts the measured signal and displays the actual value of the volume or mass. The electrical connection is provided via two cable glands.

8.2. Functional overview

Display and operating keys**Note:**

The following functional overview uses a picture of a panel-mounted variant of the unit, but applies to all variants of Type 8025.

The display is used to:

- read the value of certain parameters e.g. for the flowmeter, the measured flow rate, the main totalizer
- set parameters of the device by means of 3 keys
- read the configuration of the device
- be warned of certain events.

Display and operating keys	No.	Description
	1	<p>“Back” key:</p> <ul style="list-style-type: none"> to change the value (0...9) of the selected digit to go back to the previous function read the batches history (only for batch controller)
	2	<p>“Next” key:</p> <ul style="list-style-type: none"> to select the digit at the left to go to the next function read messages (only with Insertion flowmeter as battery powered indicator/totalizer and with batch controller)
	3	<p>“Confirm” key:</p> <ul style="list-style-type: none"> to confirm the function displayed to confirm the parameters set
	4	<ul style="list-style-type: none"> For Insertion flowmeter with standard output signal and for transmitter for “Low Power” flowmeters <ul style="list-style-type: none"> status LED of relay 2 For Universal transmitter and batch controller <ul style="list-style-type: none"> status LED of relay DO3 (LED ON = contact closed)
	5	<ul style="list-style-type: none"> For Insertion flowmeter with standard output signal and for transmitter for “Low Power” flowmeters <ul style="list-style-type: none"> status LED of relay 1 For Universal transmitter and batch controller <ul style="list-style-type: none"> status LED of relay DO2 (LED ON = contact closed)
	6	<p>Status of device:</p> <ul style="list-style-type: none"> No status for Insertion flowmeter with standard output signal and for transmitter for “Low Power” flowmeters For Insertion flowmeter as a battery powered indicator/totalizer <ul style="list-style-type: none"> off: the device operates correctly. blinking orange: a warning message is generated in the information menu. blinking red: a fault message is generated in the information menu. For Universal transmitter <ul style="list-style-type: none"> green: the device operates correctly. orange: a warning message is generated in the information menu. red: a fault message is generated in the information menu and a 22 mA current is sent on the current output if activated. blinking, whatever the colour: a check for the correct behaviour of the output is running. The standard measurement function is inactive. For batch controller <ul style="list-style-type: none"> green: the device operates correctly. orange: an alarm related to the dosing and/or a warning message is generated in the information menu. red: a fault message is generated in the information menu. blinking, whatever the colour: <ul style="list-style-type: none"> slow blinking: the dosing is interrupted. fast blinking during a dosing: a dosing related alarm is generated. fast blinking when no dosing is being done: the information menu has been remote-consulted or a check for the correct behaviour of the inputs/outputs is running.

DTS 1000011079 EN Version: AF Status: RL (released | freigegeben | valide) printed: 13.01.2025

The device can be calibrated by means of the K factor of the fitting or via the teach function. User adjustments, such as engineering units, output, filter and bargraph are carried out on site.

Flowmeter with standard output signal or flow transmitter

The device has 2 operating levels:

- the process level
- the configuration level, which comprises the parameters and the test menus

Operating level	Functions
Process	This level allows: <ul style="list-style-type: none"> • to read <ul style="list-style-type: none"> – the value of the measured flow – the value of the 4...20 mA output – the value of the main totalizer – the value of the daily totalizer • to reset the daily totalizer • to access to the parameters and test menus of the configuration level
Configuration - parameters menu	This level allows: <ul style="list-style-type: none"> • to set the required operation parameters: <ul style="list-style-type: none"> – language – engineering units (international measuring units) – K factor/Teach function – 4...20-mA-current output – pulse output – relay (on devices with relays) – filter (damping) – resetting both totalizers – low flow “Cut Off” (only for Universal transmitter) – brightness of the display (backlight, only for Universal transmitter)
Configuration - test menu	This level allows: <ul style="list-style-type: none"> • to adjust the Offset and Span of the 4...20 mA current output • to read the rotational frequency of the paddle wheel • to check the correct operating of the outputs with simulating a flow rate • to generate warning and fault messages (only for Universal transmitter)

DTS 1000011079 EN Version: AF Status: RL (released | freigegeben | validé) printed: 13.01.2025

Flowmeter as battery powered indicator/totalizer

The device has 2 operating levels:

- the process level
- the configuration level, which comprises the parameters, the test and the information menus

Operating level	Functions
Process	This level allows: <ul style="list-style-type: none"> • to read <ul style="list-style-type: none"> – the value of the measured flow – the value of the main totalizer – the value of the daily totalizer • to reset the daily totalizer • to access to the parameters, test and information menus of the configuration level
Configuration - parameters menu	This level allows: <ul style="list-style-type: none"> • to set the required operation parameters <ul style="list-style-type: none"> – language – engineering units (international measuring units) – K factor/Teach function – filter (damping) – resetting both totalizers
Configuration - test menu	This level allows: <ul style="list-style-type: none"> • to read the rotational frequency of the paddle wheel • to generate warning and error messages
Configuration - information menu	This level allows: <ul style="list-style-type: none"> • to read <ul style="list-style-type: none"> – the charge of the batteries – the error or warning messages

DTS 1000011079 EN Version: AF Status: RL (released | freigegeben | validé) printed: 13.01.2025

Batch controller, compact or remote variants

The device has 2 operating levels:

- the process level
- the configuration level, which includes the parameters, the test, the information and the history menus

Operating level	Functions
Process	<p>This level allows:</p> <ul style="list-style-type: none"> • to start a dosing • to read <ul style="list-style-type: none"> – the value of the main totalizer of the quantity of fluid counted – the value of the daily totalizer of the quantity of fluid counted – the value of the main totalizer of the performed dosings – the value of the daily totalizer of the performed dosings • to reset <ul style="list-style-type: none"> – the daily volume or mass totalizer – the daily totalizer of the performed dosings • to access to the parameters, test, information and history menus of the configuration level
Configuration - parameters menu	<p>This level allows:</p> <ul style="list-style-type: none"> • to set the required operation parameters <ul style="list-style-type: none"> – language – engineering units (international measuring units) – K factor/Teach function – optional/dosing mode – overflow – alarm – outputs – resetting the 2 volume or mass totalizers – resetting the 2 totalizers of the performed dosings – resetting the history menu – backlight
Configuration - test menu	<p>This level allows:</p> <ul style="list-style-type: none"> • to check <ul style="list-style-type: none"> – the inputs functions – the outputs functions – the paddle-wheel operation • to monitor <ul style="list-style-type: none"> – the flow rate in the pipe – the value of the daily volume or mass totalizer – the number of performed dosings • to save/ restore <ul style="list-style-type: none"> – the current user configuration – the saved configuration – the default configuration of the device
Configuration - history menu	<p>This level allows to consult the quantities dosed in the last 10 dosings</p>
Configuration - information menu	<p>This level allows to read the fault and warning messages generated</p>

DTS 1000011079 EN Version: AF Status: RL (released | freigegeben | validé) printed: 13.01.2025

8.3. Function modes

Flowmeter with standard output signal

- 4...20 mA output + Pulse
- 4...20 mA output + Pulse + relay output
Hysteresis switching mode (both relays) for the output, inverted or not

Hysteresis mode

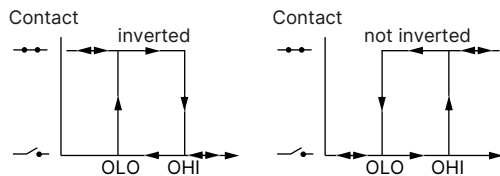

Batch controller, compact or remote variants

The following dosing modes are possible:

- **Locally started dosing of**
 - **free quantity:** the user enters the quantity to be filled and starts the dosing from the keypad.
 - **pre-set quantity:** the user selects a quantity which has been pre-set and starts the dosing from the keypad.
- **Dosing controlled by a PLC unit:** the user selects a quantity which has been pre-set and starts the dosing using binary inputs.
- **Locally/remote selection of pre-set quantity and dosing controlled by a PLC unit:** the user selects a quantity which has been pre-set from the keypad or using binary inputs and starts the dosing using binary inputs.
- **Automatic dosing controlled by variation of pulse duration:** the volume to be dosed is directly proportional to the duration of a pulse.
- **Locally/remote dosing determined by teach-in:**
 - teach-in of the dosing quantity from the keypads
 - teach-in of the dosing quantity using binary inputs.

9. Product design and assembly

9.1. Product assembly

Flowmeter or compact batch controller

Note:

- The device Type 8025 is installed into a Bürkert Insertion fitting Type S020 and fastened with a union nut.
- The Insertion fitting Type S020 ensures simple installation into pipes from DN 20...DN 400, see **data sheet Type S020** ▶ for more information.

The device is equipped with a sensor with a paddle wheel, available in long or short variant (depending on the size of the used Insertion fitting). The sensor armature is plugged-in to the housing, which contains the electronic board with display and parameter keys.

The electrical connection is provided for the flowmeter via a cable plug or two cable glands (variant with standard output signal) and for the batch controller via two cable glands.

Compact flowmeter or compact batch controller with a G 2" process connection



Insertion fitting Type S020



Complete device for flow measurement or dosing Type 8025

Fitting in stainless steel (only example)

Flow transmitter or remote batch controller

Note:

The remote device Type 8025 is available in a wall-mounted or panel variant.

The panel variant is made up of an electronics integrated in an open housing with display. The electrical connection is carried out on the terminal blocks of the electronic board.



The wall-mounted variant is made up of an electronics integrated in a housing with cover and display. The electrical connection is carried out on the terminal blocks of the electronic board via three cable glands (for flow transmitter) or five cable glands (for batch controller).



DTS 1000011079 EN Version: AF Status: RL (released | freigegeben | validé) printed: 13.01.2025

10. Networking and combination with other Bürkert products

10.1. Networking and combination of the compact device

Flowmeter with standard output signal

Example:



Type 8025

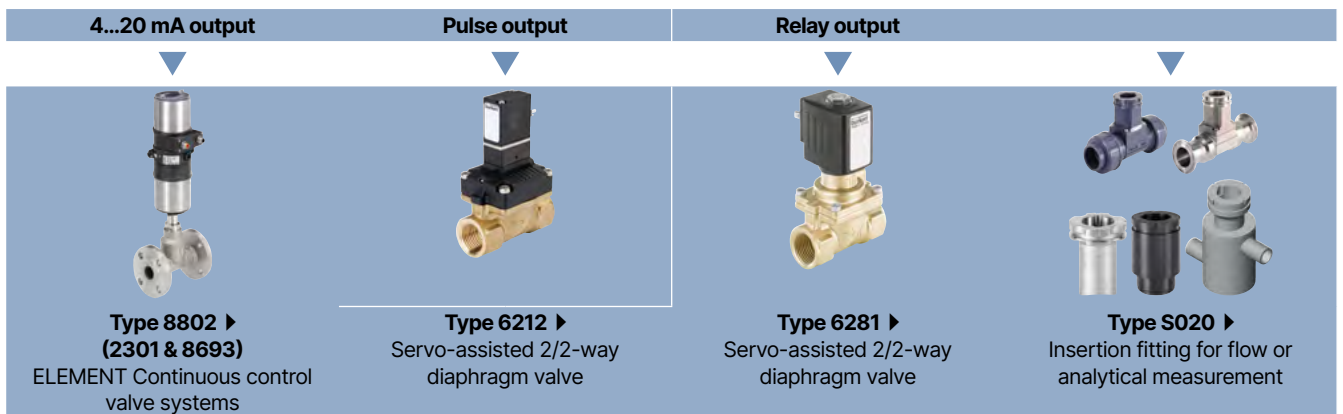

Compact batch controller

Example:

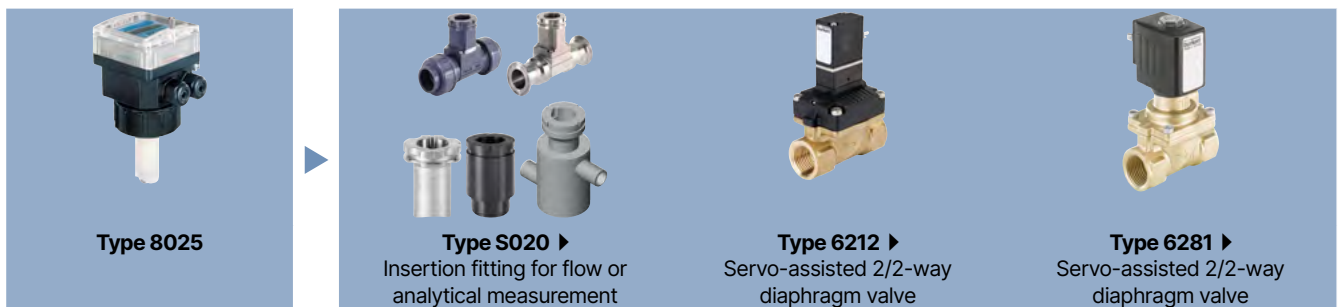









10.2. Combination of the compact device with available Type S020 Insertion fittings DN

Available S020 fittings DN	DN20	DN50	DN65	DN100	DN200	DN350	DN400
T-Fitting	short sensor						
Welding socket		short sensor			long sensor		
Fusion spigot			short sensor		long sensor		
Screw-on spigot					long sensor		
Saddle		long sensor					

10.3. Combination of the remote device

Note:

Connection possibilities according to the flow meter variant

							
		Universal transmitter		Transmitter for "Low Power" flowmeters		Remote batch controller	
		Panel	Wall-mounted	Panel	Wall-mounted	Panel	Wall-mounted
	Hall variant (short or long) Frequency output with pulse signal (NPN, PNP, open collector)	Yes	Yes	No	No	Yes	Yes
	Hall „Low Power“ variant (short or long) Frequency output with pulse signal (NPN, open collector)	Yes	Yes	Yes	Yes	Yes	Yes
Type 8020 ▶ Insertion flowmeter							
	Hall variant Frequency output with pulse signal (NPN, PNP, open collector)	Yes	Yes	No	No	Yes	Yes
	Hall „Low Power“ variant Frequency output with pulse signal (NPN, open collector)	Yes	Yes	Yes	Yes	Yes	Yes
Type 8030 (SE30 + S030) ▶ or Type SE30+S077 ▶ Inline flowmeter							
	Frequency output with pulse signal (NPN, PNP, open collector)	Yes	Yes	No	No	Yes	Yes
Type 8030 HT ▶ Inline flowmeter for high temperature							
	–	Yes	Yes	No	No	Yes	Yes
Type SE30 Ex + (S030 or S077) ▶ Inline flowmeter for hazardous areas							
	Frequency output with pulse signal (NPN)	Yes	Yes	No	No	Yes	Yes
Type 8031 ▶ Flow sensor for low-flow measurement							
	Frequency output with pulse signal (NPN)	Yes	Yes ¹⁾	No	No	Yes	Yes ¹⁾
Type 8041 ▶ Insertion magnetic inductive flowmeter							
	Frequency output with pulse signal (NPN)	Yes	Yes	No	No	Yes	Yes
Type 8071 ▶ or Type 8077 ▶ Flowmeter with oval rotors							

1.) Except device with Article no. 419543

DTS 1000011079 EN Version: AF Status: RL (released | freigegeben | validé) printed: 13.01.2025

11. Ordering information

11.1. Bürkert eShop



Bürkert eShop – Easy ordering and quick delivery

You want to find your desired Bürkert product or spare part quickly and order directly? Our online shop is available for you 24/7. Sign up and enjoy all the benefits.

[Order online now](#)

11.2. Recommendation regarding product selection

Compact flowmeter or compact batch controller

A compact and complete flow measurement or batch control equipment consists of a compact flowmeter or batch controller Type 8025 and a Bürkert Insertion fitting Type S020.

See [data sheet Type S020](#) ▶ for more information.

Two different components must be ordered in order to select a complete device. The following information is required:

- **Article no.** of the desired compact flowmeter or batch controller Type 8025 (see chapter [“Flowmeter” on page 36](#) or [“Compact batch controller” on page 37](#))
- **Article no.** of the selected Type S020 Insertion fitting (see [data sheet Type S020](#) ▶)

Universal flow transmitter

This transmitter Type 8025 (wall-mounted or panel-mounted variant) has to be connected to Bürkert flowmeters or to any other compatible flowmeter of a third-party provider.

Two different components must be ordered in order to select a complete device. The following information is required:

- **Article no.** of the desired Type 8025 Universal transmitter (see chapter [“Universal transmitter” on page 37](#))
- **Article no.** of the selected Bürkert flowmeter (see chapter [“10.3. Combination of the remote device” on page 34](#) and also the corresponding data sheet)

Flow transmitter for “Low Power” flowmeters

This transmitter Type 8025 (wall-mounted or panel-mounted variant) has to be connected **only** to Bürkert “Low Power” flowmeters, i.e:

- a Bürkert Type 8020 flowmeter “Low Power” variant associated to an Insertion fitting Type S020 or
- a Type SE30 flow transmitter “Low Power” variant associated to an Inline sensor-fitting. The Inline sensor-fitting can be either Type S030 (SE30+S030 = Type 8030) or Type S077.

Three different components must be ordered in order to select a complete device. The following information is required:

- **Article no.** of the desired Type 8025 transmitter for “Low Power” flowmeters (see chapter [“Flow transmitter for “Low Power” flowmeters” on page 37](#))
- **Article no.** of the selected Bürkert Type 8020 flowmeter or Type SE30 flow transmitter (pulse “Low Power” variant) (see chapter [“10.3. Combination of the remote device” on page 34](#) and also [data sheet Type 8020](#) ▶ or [data sheet Type 8030](#) ▶)
- **Article no.** of the selected Bürkert Insertion fitting Type S020 (DN 20...DN 400) or Bürkert Inline sensor-fitting Type S030 (DN 06...DN 65) or Inline sensor-fitting Type S077 (DN 15...DN 100) (see [data sheet Type S020](#) ▶, [data sheet Type S030](#) ▶ or [data sheet Type S077](#) ▶).

Remote batch controller

This batch controller Type 8025 (wall-mounted or panel-mounted variant) has to be connected to Bürkert flowmeters or to any other compatible flowmeter of a third-party provider.

Two different components must be ordered in order to select a complete device. The following information is required:

- **Article no.** of the desired remote Type 8025 batch controller (see chapter **“Remote batch controller”** on page 38)
- **Article no.** of the selected Bürkert flowmeter (see chapter **“10.3. Combination of the remote device”** on page 34 and also the corresponding data sheet) or others

11.3. Bürkert product filter

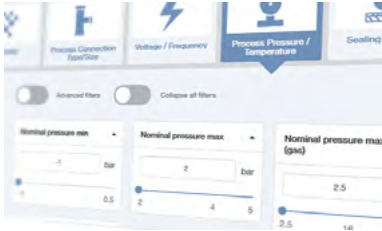

Bürkert product filter – Get quickly to the right product

You want to select products comfortably based on your technical requirements? Use the Bürkert product filter and find suitable articles for your application quickly and easily.

Try out our product filter

11.4. Ordering chart

Flowmeter

Note:

- The following is supplied with every device: FKM seal as standard (already mounted), 1 set with a black EPDM seal for the sensor, a stopper for unused M20 × 1.5 cable gland, a 2 × 6 mm multi-way seal for cable gland and a mounting instruction sheet.
- The following variants have at least 2 volume totalizers.

Operating voltage	Sensor variant	Output	UL approval	Electrical connection	Article no.	
Flowmeter with standard output signal						
12...36 V DC	Hall, short	4...20 mA (2-wire) + pulse	–	Female cable plug DIN EN 175301-803	418762	
			UL Recognized		570457	
			–	2 cable glands	418802	
			UL Recognized		570465	
			Hall, long	–	Female cable plug DIN EN 175301-803	418763
				UL Recognized		570458
	Hall, short	4...20 mA (3-wire) + pulse + 2 relays	–	2 cable glands	418803	
			UL Recognized		570466	
			–	2 cable glands	418778	
			UL Recognized		570461	
			–		418779	
			UL Recognized		570462	
115/230 V AC	Hall, short	4...20 mA (2-wire) + pulse	–		418423	
	Hall, long				418424	
	Hall, short	4...20 mA (3-wire) + pulse + 2 relays			418431	
	Hall, long				418432	
Flowmeter as battery powered indicator/totalizer						
4 × 1.5 V DC AA Batteries	Coil, short	None	–	None	418403	
	Coil, long				418405	

Further variants on request









Approval
FDA, UL Recognized for USA and Canada (UL 61010-1 + CAN/CSA-C22.2 No. 61010-1)

DTS 1000011079 EN Version: AF Status: RL (released | freigegeben | valide) printed: 13.01.2025

Compact batch controller

Note:







- The following is supplied with every device: FKM seal as standard (already mounted), 1 set with a black EPDM seal for the sensor, a stopper for unused M20 × 1.5 cable gland, a 2 × 6 mm multi-way seal for cable gland and a mounting instruction sheet.
- The following variants have at least 2 volume or mass totalizers and 2 totalizers of the number of dosing performed.

Operating voltage	Sensor variant	Input	Output	UL approval	Electrical connection	Article no.
12...36 V DC	Hall, short	4 digital inputs (DI1...DI4)	2 transistor outputs (DO1 and DO4) + 2 relay outputs (DO2 and DO3)	-	2 cable glands	419520 
				UL Recognized		564414 
	-			419522 		
	UL Recognized			570469 		
115/230 V AC	Hall, short			-		419521 
	Hall, long					419529 

Universal transmitter

Note:









- Sensor variant: Types 8020, 8030 (SE30+S030), SE30+S077, 8041, 8071, 8077... (see chapter "10.3. Combination of the remote device" on page 34).
- The following variants have at least 2 volume totalizers.

Operating voltage	Output	UL approval	Electrical connection	Article no.
Panel mounted variant				
12...36 V DC	1current output 4...20 mA (AO1, 3-wire) + 1 pulse output (DO1)	-	Terminal strip	419538 
		UL Recognized		564416 
	1current output 4...20 mA (AO1, 3-wire) + 1 pulse output (DO1) + 2 relay outputs (DO2 and DO3)	-		419537 
		UL Recognized		564417 
Wall-mounted variant				
12...36 V DC	1current output 4...20 mA (AO1, 3-wire) + 1 pulse output (DO1)	-	3 cable glands	419541 
	1current output 4...20 mA (AO1, 3-wire) + 1 pulse output (DO1) + 2 relay outputs (DO2 and DO3)			419540 
	115/230 V AC			1current output 4...20 mA (AO1, 3-wire) + 1 pulse output (DO1)
	1current output 4...20 mA (AO1, 3-wire) + 1 pulse output (DO1) + 2 relay outputs (DO2 and DO3)			419543 

Flow transmitter for "Low Power" flowmeters

Note:





- Sensor variant: only Types 8020, 8030 and SE30+S077 in "Low Power" variant (see chapter "10.3. Combination of the remote device" on page 34).
- The following variants have at least 2 volume totalizers.

Operating voltage	Output	UL approval	Electrical connection	Article no.
Panel mounted variant				
12...36 V DC	4...20 mA (2-wire) + pulse	-	Terminal strip	418992 
		UL Recognized		552725 
	4...20 mA (3-wire) + pulse + 2 relays	-		418994 
		UL Recognized		552726 
Wall-mounted variant				
12...36 V DC	4...20 mA (2-wire) + pulse	-	3 cable glands	418397 
	4...20 mA (3-wires) + pulse + 2 relays			418396 
115/230 V AC	4...20 mA (2-wire) + pulse			418400 
	4...20 mA (3-wire) + pulse + 2 relays			418399 

Remote batch controller









Note:

- Sensor variant: Types 8020, 8030 (SE30+S030), SE30+S077, 8041, 8071, 8077... (see chapter "10.3. Combination of the remote device" on page 34.
- The following variants have at least 2 volume or mass totalizers and 2 totalizers of the number of dosing performed.



Operating voltage	Input	Output	UL approval	Electrical connection	Article no.
Panel mounted variant					
12...36 V DC	4 digital inputs (DI1...DI4)	2 transistor outputs (DO1 and DO4) + 2 relay outputs (DO2 and DO3)	–	Terminal strip	419536 
			UL Recognized		564415 
Wall-mounted variant					
12...36 V DC	4 digital inputs (DI1...DI4)	2 transistor outputs (DO1 et DO4) + 2 relay outputs (DO2 et DO3)	–	5 cable glands	433740 
115/230 V AC					433741 

11.5. Ordering chart accessories

Accessories for compact device

Description	Article no.
For flowmeter or compact batch controller	
Set with two cable glands M20 × 1.5, two neoprene flat seals for cable gland or plug, two screw plugs M20 × 1.5 and two multi-way seals 2 × 6 mm	449755 
Set with two adaptors M20 × 1.5 /NPT ½", two neoprene flat seals for cable gland or plug and two screw plugs M20 × 1.5	551782 
Set with a stopper for unused cable gland M20 × 1.5, a multi-way seal 2 × 6 mm for cable gland, a black EPDM seal for the sensor and a mounting instruction sheet	551775 
Set with a green FKM seal and a black EPDM seal	552111 
Fastening ring (open) for Type S020 Insertion fitting	619205 
PC union nut for Type S020 Insertion fitting	619204 
For flowmeter	
Female cable plug, 4-pin (3 conductors + protective conductor), form A according to DIN EN 175301-803 with cable gland (Type 2518 ▶)	572264 
Female cable plug 32 mm, 4-pin (3 conductors + protective conductor), form A according to DIN EN 175301-803, with NPT ½" reduction without cable gland (Type 2509 ▶)	162673 
For batch controller	
Set with 8 FLOW front panel films	553191 

Accessories for remote device

Description	Article no.
For flowmeter or remote batch controller, panel variant	
Mounting set (screws, spring lock washers, hexagon nuts, cable clips)	554807 
Flat seal	419350 
Set with 8 FLOW front panel films	553191 
For flowmeter or remote batch controller, wall-mounted variant	
Power supply board 115/230 V AC + mounting instruction sheet	555722 