





### Servo-assisted 2-way high-flow solenoid control valve

- Control valve for continuous control of liquids
- Low hysteresis and high repeatability
- Control with PWM signal
- Servo-assisted, tight closing valve



Product variants described in the data sheet may differ from the product presentation and description.

#### Can be combined with

	<b>Type 2518</b> Cable plug, form A according to DIN EN 175301-803	▶
	<b>Type 8605</b> PWM control electronics for electromagnetic proportional valves	▶

#### Type description

The valve Type 6223 can be used for the control of larger flow quantities. Low hysteresis, high reproducibility and good response sensitivity guarantee good positioning behaviour. The valve closes tight. The push-over coil is easy to replace.

## Table of contents

<b>1. General technical data</b>	<b>3</b>
<b>2. Circuit functions</b>	<b>3</b>
<b>3. Approvals and conformities</b>	<b>4</b>
3.1. General notes .....	4
3.2. Conformity .....	4
3.3. Standards .....	4
<b>4. Materials</b>	<b>4</b>
4.1. Bürkert resistApp .....	4
<b>5. Dimensions</b>	<b>5</b>
5.1. DN 10 variant with coil size 5 .....	5
5.2. DN 13 variant with coil size 6 .....	6
5.3. DN 20 variant with coil size K .....	6
<b>6. Performance specifications</b>	<b>7</b>
6.1. Flow characteristic .....	7
Determination of the $K_v$ value .....	7
6.2. Exemplary characteristic curve of a proportional valve .....	7
<b>7. Ordering information</b>	<b>8</b>
7.1. Bürkert eShop .....	8
7.2. Recommendation regarding product selection .....	8
7.3. Bürkert product filter .....	8
7.4. Bürkert Product Enquiry Form .....	8
7.5. Ordering chart .....	9
7.6. Ordering chart accessories .....	9
Cable plug Type 2518, form A according to DIN EN 175301 - 803 .....	9
Control electronics Type 8605 for proportional valves .....	10

## 1. General technical data

Product properties	
Dimensions	Further information can be found in chapter "5. Dimensions" on page 5.
Material	
Seal	FKM, others on request
Body	Brass, stainless steel on request
Circuit function	A Further information can be found in chapter "2. Circuit functions" on page 3.
Performance data	
Typical values of positioning behaviour <sup>1.)</sup>	
Hysteresis	< 5 %
Repeat accuracy	< 1 % FS <sup>2.)</sup>
Response sensitivity	< 1 % FS <sup>2.)</sup>
Setting range	1:10
Actuating time (10...90 %)	< 200 ms
Pressure range <sup>3.)</sup>	0.5...10 bar
Duty cycle	100 % continuous operation
Electrical data	
Operating voltage	24 V DC (12 V on request)
Power consumption	Further information can be found in chapter "7.5. Ordering chart" on page 9.
Maximum coil current <sup>4.)</sup>	Further information can be found in chapter "7.5. Ordering chart" on page 9.
PWM frequency <sup>5.)</sup>	280 Hz
Medium data	
Medium	Neutral liquids
Medium temperature	- 10 °C... + 90 °C
Viscosity	Max. 21 mm <sup>2</sup> /s (21 cSt)
Product connections	
Electrical connection	Plug contacts according to DIN EN 175301 - 803 form A for cable plug <b>Type 2518</b> ▶. Further information can be found in chapter "Cable plug Type 2518, form A according to DIN EN 175301 - 803" on page 9.
Port connection	G 3/8, G 1/2, G 3/4, G 1
Approvals and conformities	
Degree of protection	IP65
Environment and installation	
Installation position	As required, preferably with actuator upright
Ambient temperature	Max. + 55 °C

1.) Characteristic data of control behaviour depends on process conditions.

2.) With flow measurement

3.) Pressure data: Overpressure with respect to atmospheric pressure, depending on nominal diameter, tightness seal or nominal pressure

4.) Maximum value: value depends on operating pressure

5.) PWM: pulse-width modulation

## 2. Circuit functions

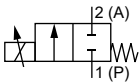
Symbol	Description
	<b>Circuit function A (CF A)</b> 2/2-way solenoid proportional control valve Direct-acting Normally closed

### 3. Approvals and conformities

#### 3.1. General notes

- The approvals and conformities listed below must be stated when making enquiries. This is the only way to ensure that the product complies with all required specifications.
- Not all available variants can be supplied with the below mentioned approvals or conformities.

#### 3.2. Conformity

In accordance with the Declaration of Conformity, the product is compliant with the EU Directives.

#### 3.3. Standards

The applied standards which are used to demonstrate compliance with the EU Directives are listed in the EU-Type Examination Certificate and/or the EU Declaration of Conformity.

### 4. Materials

#### 4.1. Bürkert resistApp

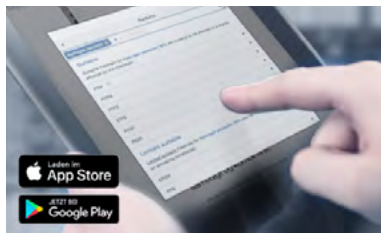

##### Bürkert resistApp – Chemical resistance chart

You want to ensure the reliability and durability of the materials in your individual application case? Verify your combination of media and materials on our website or in our resistApp.

[Start chemical resistance check](#)

## 5. Dimensions

### 5.1. DN 10 variant with coil size 5

**Note:**

Dimensions in mm

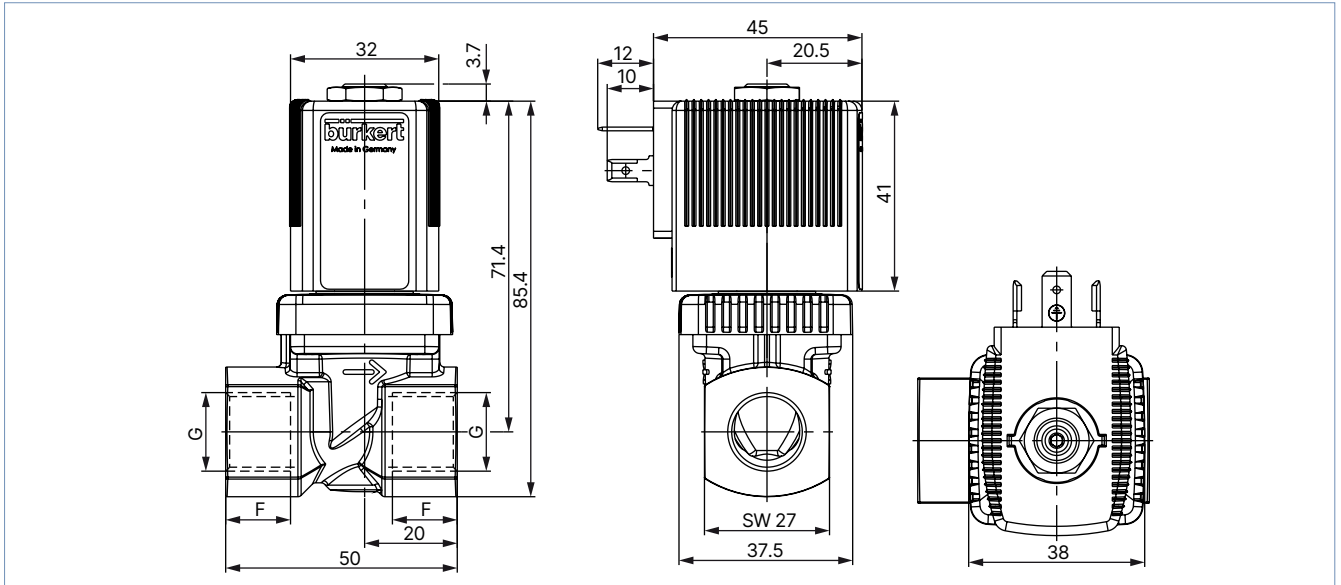

DN	F1	G1	F2	G2	F3	G3
DN 10	12	G 3/8	10.3	NPT 3/8	10.1	Rc 3/8
	14	G 1/2	13.7	NPT 1/2	13.2	Rc 1/2

5.2. DN 13 variant with coil size 6

Note:

Dimensions in mm

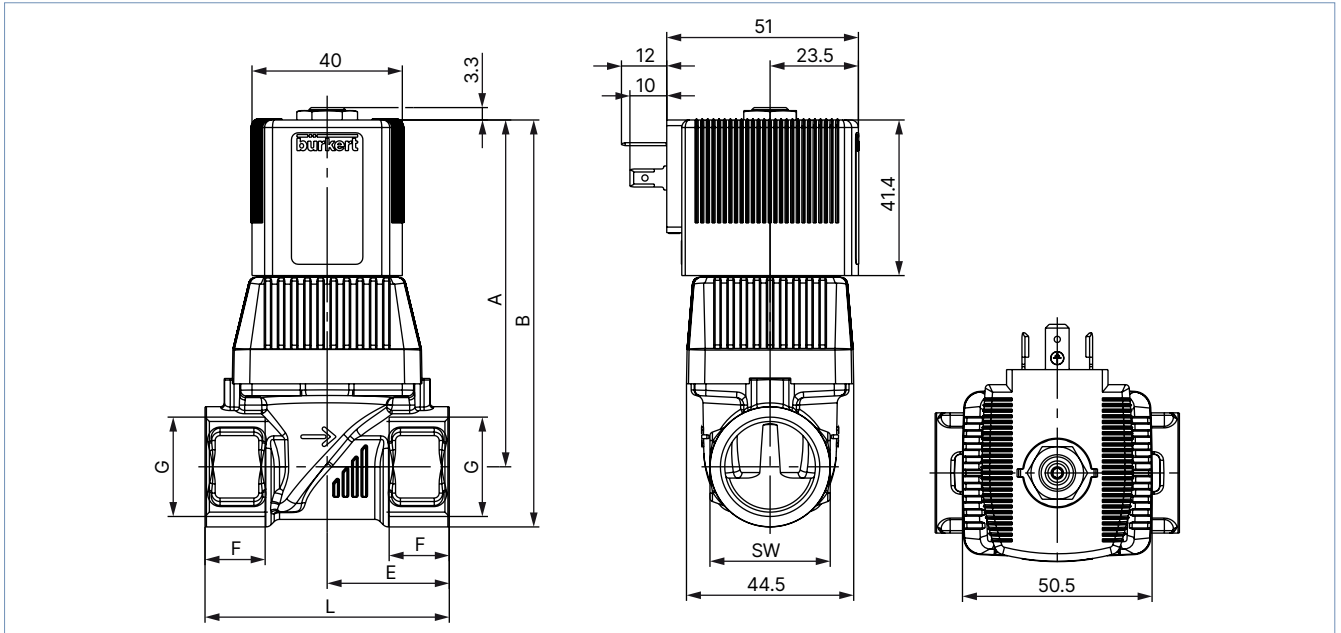

DN	A	B	E (MS/VA)	F1	G1	F2	G2	F3	G3	L (MS/VA)	SW
DN 13	90.3	103.8	27.25/32.5	14	G 1/2	13.7	NPT 1/2	13.2	Rc 1/2	58/65	27
	92.3	108.3	32.5	16	G 3/4	14	NPT 3/4	14.5	Rc 3/4	65	32

5.3. DN 20 variant with coil size K

Note:

Dimensions in mm

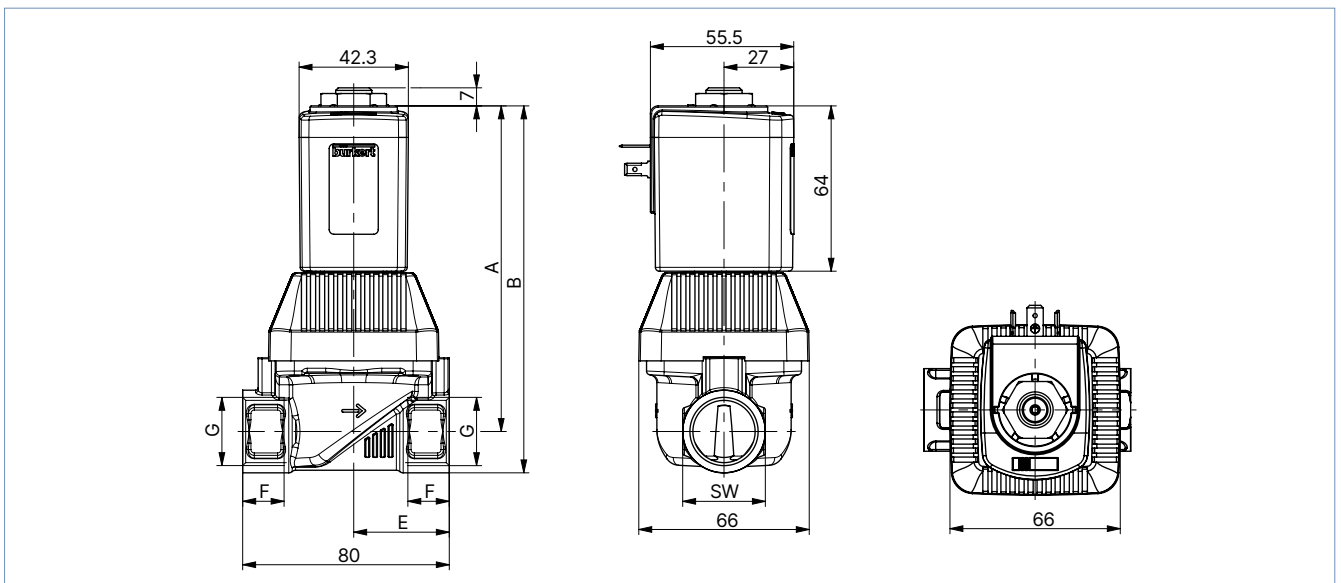

DN	A	B	E	F1	G1	F2	G2	F3	G3	SW
DN 20	126.1	142.1	37	16	G 3/4	14	NPT 3/4	14.5	Rc 3/4	32
	128.6	149.1	37.5	18	G 1	16.8	NPT 1	16.8	Rc 1	41

DTS 1000011057 EN Version: N Status: RL (released | freigegeben | valide) printed: 26.01.2026

## 6. Performance specifications

### 6.1. Flow characteristic

#### Determination of the $K_v$ value

Pressure drop	$K_v$ value for liquids [m <sup>3</sup> /h]	$K_v$ value for gases [m <sup>3</sup> /h]
<b>Sub-critical</b> $p_2 > \frac{p_1}{2}$	$= Q \sqrt{\frac{\rho}{1000 \Delta p}}$	$= \frac{Q_N}{514} \sqrt{\frac{T_1 \rho_N}{p_2 \Delta p}}$
<b>Supercritical</b> $p_2 < \frac{p_1}{2}$	$= Q \sqrt{\frac{\rho}{1000 \Delta p}}$	$= \frac{Q_N}{257 p_1} \sqrt{T_1 \rho_N}$

Value	Description	Unit
$K_v$	Flow coefficient	[m <sup>3</sup> /h] <sup>1.)</sup>
$Q_N$	Standard flow rate	[m <sup>3</sup> /h] <sup>2.)</sup>
$p_1$	Inlet pressure	[bar] <sup>3.)</sup>
$p_2$	Outlet pressure	[bar] <sup>3.)</sup>
$\Delta p$	Differential pressure $p_1 \dots p_2$	[bar]
$\rho$	Density	[kg/m <sup>3</sup> ]
$\rho_N$	Standard density	[kg/m <sup>3</sup> ]
$T_1$	Medium temperature	[(273+t)K]

- 1.) Measured for water,  $\Delta p = 1$  bar, over the valve
- 2.) At reference conditions 1.013 bar and 0 °C (273 K)
- 3.) Absolute pressure

### 6.2. Exemplary characteristic curve of a proportional valve

#### Note:

The dimensioning of the nominal diameter is very important for proportional valves to function properly within the application. The nominal diameter must be selected so that, on the one hand, the desired flow range is achieved and, on the other hand, when the valve is fully open, a sufficient portion of the total pressure drop occurs across the valve.

Reference value:  $\Delta p_{\text{valve}} > 25\%$  of the total pressure drop

Otherwise, an ideal, linear valve characteristic is deformed into a curved system characteristic.

If the differential pressure (difference between inlet and outlet pressure) exceeds half the value of the nominal pressure discontinuities may occur.

For that reason take advantage of Bürkert competent engineering services during the planning phase.

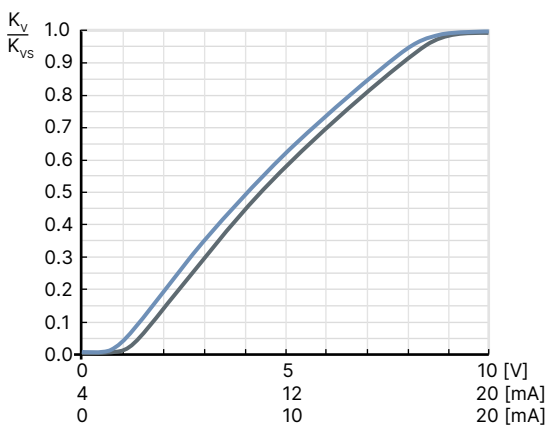

## 7. Ordering information

### 7.1. Bürkert eShop



#### Bürkert eShop – Easy ordering and quick delivery

You want to find your desired Bürkert product or spare part quickly and order directly? Our online shop is available for you 24/7. Sign up and enjoy all the benefits.

[Order online now](#)

### 7.2. Recommendation regarding product selection

**Note:**

- Use the product enquiry form (see “7.4. Bürkert Product Enquiry Form” on page 8) for information about the device layout and send it to us after completion.
- Please note the chapter “6.2. Exemplary characteristic curve of a proportional valve” on page 7 on product selection.

### 7.3. Bürkert product filter



#### Bürkert product filter – Get quickly to the right product

You want to select products comfortably based on your technical requirements? Use the Bürkert product filter and find suitable articles for your application quickly and easily.

[Try out our product filter](#)

### 7.4. Bürkert Product Enquiry Form

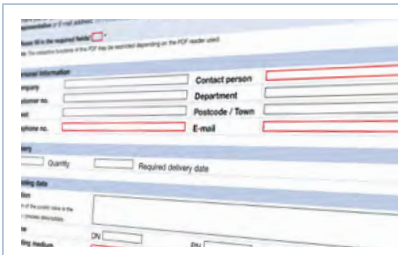

#### Bürkert Product Enquiry Form – Your enquiry quickly and compactly

Would you like to make a specific product enquiry based on your technical requirements? Use our Product Enquiry Form for this purpose. There you will find all the relevant information for your Bürkert contact. This will enable us to provide you with the best possible advice.

[Fill out the form now](#)

DTS 1000011057 EN Version: N Status: RL (released | freigegeben | valide) printed: 26.01.2026

### 7.5. Ordering chart

**Note:**

- All valves are delivered with FKM seal.
- Please note that the cable plug must be ordered separately, see **"Cable plug Type 2518, form A according to DIN EN 175301 - 803"** on [page 9](#) or separate data sheet for **Type 2518** ▶.

Circuit function	Port connection	Orifice	K <sub>vs</sub> value water <sup>1.)</sup>	Power consumption	Maximum coil current	Pressure range <sup>2.)</sup>	Article no.
		[mm]	[m <sup>3</sup> /h]	[W]	[mA]	[bar]	
<b>CF A</b> 2/2-way solenoid proportional control valve Direct-acting Normally closed 	G 3/8	10	1.4	8	300	0.5...10	134229
	G 1/2		1.4	8	300	0.5...10	134230
	G 1/2	13	2.5	10	330	0.5...10	132202
	G 3/4		2.5	10	330	0.5...10	282985
	G 3/4	20	5.0	16	620	0.5...10	222478
	G 1		5.0	16	620	0.5...10	222477

1.) Measurement at + 20 °C, 1 bar pressure differential over a fully opened valve

2.) Pressure data: overpressure with respect to atmospheric pressure, with a differential pressure (difference between inlet and outlet pressure) above half of the nominal pressure there are discontinuities in the valve's characteristics possible."

### 7.6. Ordering chart accessories

**Cable plug Type 2518, form A according to DIN EN 175301 - 803**

**Note:**

- Dimensions in mm
- For further variants see data sheet **Type 2518** ▶.













Cable plug	Dimensions	Variant	Voltage	Article no.
		Without wiring (AC/DC)	0...250 V AC/DC	314802

DTS 1000011057 EN Version: N Status: RL (released | freigegeben | valide) printed: 26.01.2026

**Control electronics Type 8605 for proportional valves**

**Note:**

Refer to data sheet **Type 8605** ▶ for more information about the control electronics.

Control electronics	Variant	Max. coil current range [mA]	Voltage		Article no.
			24 V DC	12 V DC	
	Cable plug with PG cable gland	200...1000	X	–	316530 
	Cable plug with M12 connection	200...1000	X	–	316528 
	Cable plug with PG cable gland	500...2000	–	X	316529 
	Cable plug with M12 connection	500...2000	–	X	316526 
	Cable plug with PG cable gland without operating unit	200...1000	X	–	316521 
	Cable plug with M12 connection without operating unit	200...1000	X	–	316522 
	Cable plug with PG cable gland without operating unit	500...2000	–	X	316523 
	Cable plug with M12 connection without operating unit	500...2000	–	X	316525 
	Standard rail	200...1000	X	–	316532 
	Standard rail	500...2000	–	X	316533 

X = available  
– = not available

DTS 1000011057 EN Version: N Status: RL (released | freigegeben | valide) printed: 26.01.2026