



3/2-way pneumatic cartridge solenoid valve

- Compact design measuring 11 mm in width per station
- Nominal diameter of 0.5 mm (9 bar) to 1.2 mm (1.5 bar)
- Increased service life and reliability
- Low electrical power consumption, and optional ATEX Ex variant
- Designed for optimum integrability



Product variants described in the data sheet may differ from the product presentation and description.

Type description

Our customers' unique applications are becoming ever more complex, and installation space, fluidic performance and cost savings are critical factors. This places greater demands and more exacting requirements on the components used. Type 6164 was developed with the aim of enabling pneumatic actuation through optimal integration of the pilot valve into block or plastic injection-moulded parts, thus achieving a more compact design. The valve's uncompromising reliability, above-average lifespan, and exceptional fluidic properties mean that it, this valve type raises the bar.

Table of contents

1. General technical data	3
2. Circuit functions	4
3. Approvals and conformities	4
3.1. General notes	4
3.2. Conformity	4
3.3. Standards	4
3.4. Explosion protection	4
4. Materials	5
4.1. Bürkert resistApp	5
4.2. Material specifications	5
5. Dimensions	6
5.1. Pin and flying leads version	6
5.2. Defining of the installation area	7
Cartridge connection (fully sunken)	7
Cartridge connection (half sunken)	8
6. Device/Process connections	9
6.1. Pin assignment standard version	9
7. Performance specifications	10
7.1. Electrical data ATEX/IECEX i version	10
8. Product design and assembly	10
8.1. Application examples	10
9. Product accessories	11
9.1. Single manifold fully sunken	11
10. Ordering information	12
10.1. Bürkert eShop	12
10.2. Bürkert product filter	12
10.3. Bürkert Product Enquiry Form	12
10.4. Ordering chart	13
Standard version	13
ATEX/IECEX i version	14
10.5. Ordering chart accessories	14
Single manifold fully sunken	14
Further accessories	15

1. General technical data

Product properties	
Dimensions	Further information can be found in chapter "5. Dimensions" on page 6.
Material	
Seal	FKM
Body	PEEK
Further materials in contact with the medium	PA, LCP, MS, stainless steel Further information can be found in chapter "4.2. Material specifications" on page 5.
Permissible leakage	Vac...10 bar (dependent on the version used) ¹⁾
Weight	6 g (standard version)
Orifice	DN 0.5, DN 0.8, DN 1.0, DN 1.2
Circuit function	A, B, C, D and T Further information can be found in chapter "2. Circuit functions" on page 4.
Typical product service life	100.000.000 switching cycles (accordance to endurance tests) ²⁾
Performance data	
Pressure range	DN 0.5 (Vac...9 bar) ¹⁾ , DN 0.8 (Vac...7.5 bar) ¹⁾ , DN 1.0 (Vac...5 bar) ¹⁾ , DN 1.2 (Vac...1.5 bar) ¹⁾
Duty cycle	100 % continuous operation
Switching time ³⁾	Opening: < 5 ms (pressure build-up 0...10 %) Closing: < 5 ms (pressure reduction 100...90 %)
Electrical data	
Operating voltage	12 or 24 V DC (other voltages on request)
Power consumption	0.7 W 2.8 W/0.3 W (with external electric power reduction) 0.3 W (for explosion proof version)
Switching frequency	16 Hz
Switching noise	42 dB ⁴⁾
Voltage tolerance	± 10 %
Medium data	
Operating medium	Neutral gases
Medium temperature	- 10 °C...+ 55 °C
Process/Port connection & communication	
Electrical connection	Plug/Solder pin, flying leads
Port connection	Bürkert cartridge connection diagram
Approvals and conformities	
Degree of protection	
Pins	IP00
Male cable plug	IP40
Flying leads	IP54
Explosion protection	Further information can be found in chapter "3.4. Explosion protection" on page 4.
Environment and installation	
Installation position	As required
Ambient temperature ⁵⁾	- 10 °C...+ 55 °C

1.) Technical vacuum (-0.8 bar)

2.) Life span is dependent on temperature, pressure, sealing material and operating conditions.

3.) Measurement at valve outlet according to DIN ISO 12238:2001

4.) According to ISO 3745, test environment suspended in brass block

5.) Depends on the installation situation (see operating instructions), higher temperatures are possible on request.

2. Circuit functions

Note:

See "6.1. Pin assignment standard version" on page 9

Symbol	Description
	Circuit function A (CF A) 2/2-way solenoid valve Direct-acting Normally closed
	Circuit function B (CF B) 2/2-way solenoid valve Direct-acting Normally open
	Circuit function C (CF C) 3/2-way solenoid valve Direct-acting Normally closed
	Circuit function D (CF D) 3/2-way solenoid valve Direct-acting Normally open
	Circuit function T (CF T) 3/2-way solenoid valve Direct-acting Flow direction optional Normally closed

3. Approvals and conformities

3.1. General notes

- The approvals and conformities listed below must be stated when making enquiries. This is the only way to ensure that the product complies with all required specifications.
- Not all available versions can be supplied with the below mentioned approvals or conformities.

3.2. Conformity

In accordance with the Declaration of Conformity, the product is compliant with the EU Directives.

3.3. Standards

The applied standards which are used to demonstrate compliance with the EU Directives are listed in the EU-Type Examination Certificate and/or the EU Declaration of Conformity.

3.4. Explosion protection

Approval	Description
 	Optional: Explosion protection ATEX: BVS 16 ATEX E 088 X II 2G Ex ib IIC T6...T4 Gb II 2D Ex ib IIIB T155 °C Db IECEX: IECEX BVS 16.0053 X Ex ib IIC T6...T4 Gb Ex ib IIIB T155 °C Db

DTS 1000257619 EN Version: P Status: RL (released | freigegeben | validé) printed: 09.01.2025

4. Materials

4.1. Bürkert resistApp

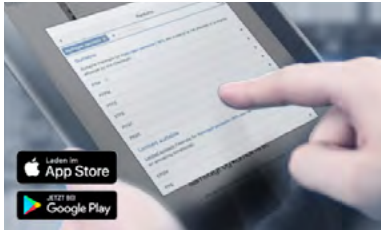

Bürkert resistApp – Chemical resistance chart

You want to ensure the reliability and durability of the materials in your individual application case? Verify your combination of media and materials on our website or in our resistApp.

[Start chemical resistance check](#)

4.2. Material specifications

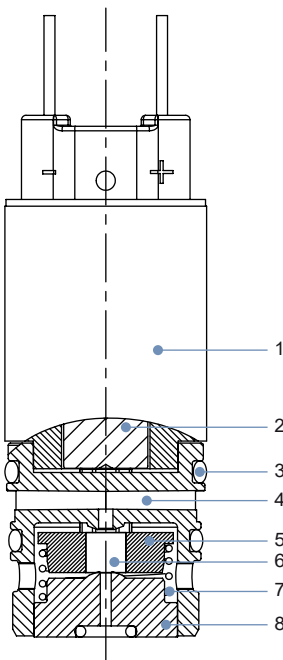

No.	Element	Material
1	Coil housing	Stainless steel 1.4113
2	Core ¹⁾	Stainless steel 1.4113
3	O-rings ¹⁾	FKM
4	Body ¹⁾	PEEK
5	Seal switch ¹⁾	PA
6	Seal ¹⁾	FKM
7	Spring ¹⁾	Stainless steel 1.4310
8	Fitting ¹⁾	Brass
-	Coil body ¹⁾ (not visible)	LCP

1.) in contact with medium

5. Dimensions

5.1. Pin and flying leads version

Note:

Dimensions in mm

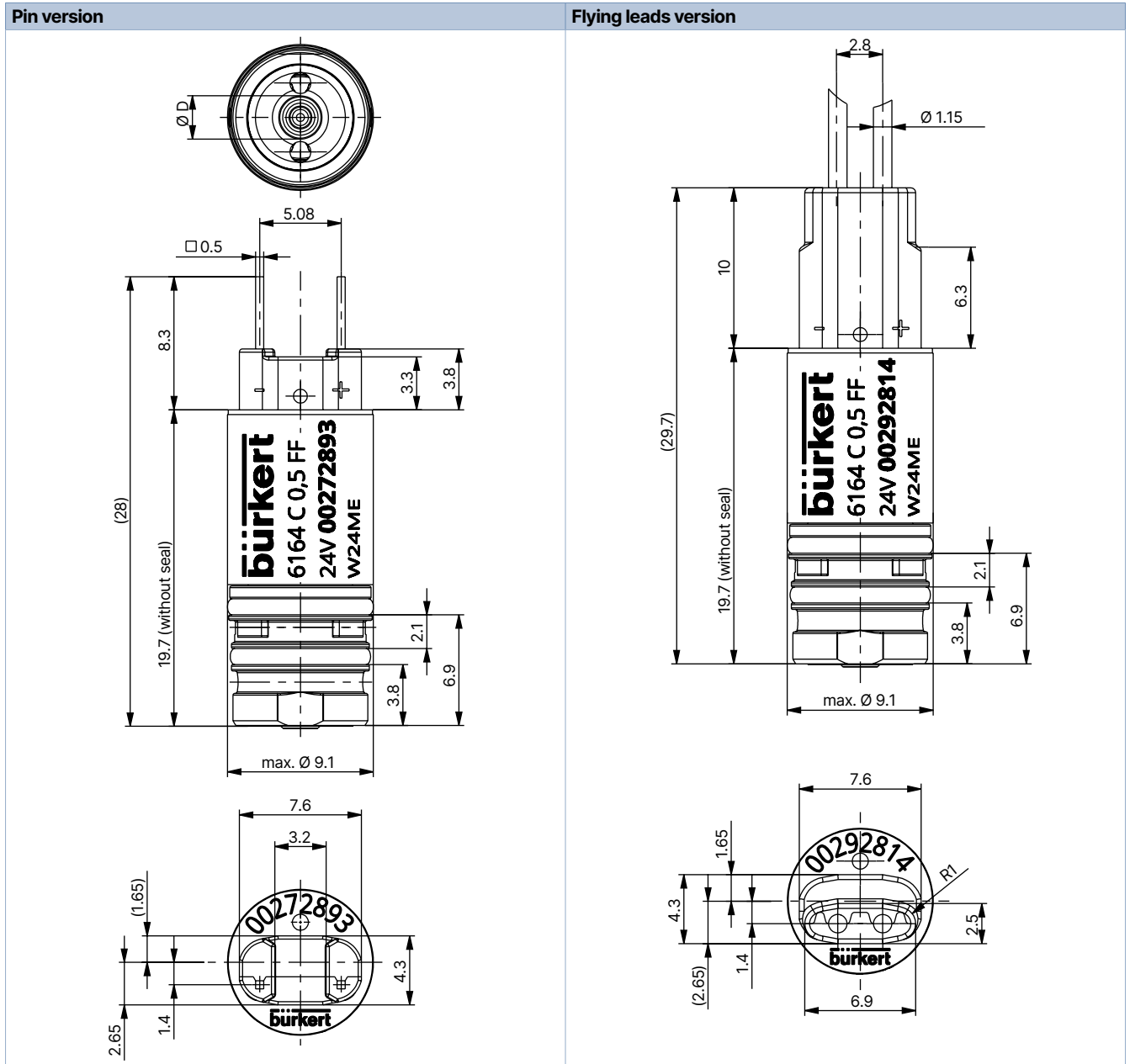

Version	Measurement D
DN < 0.65	Ø 2.7
DN > 0.65	Ø 3.3

DTS 1000257619 EN Version: P Status: RL (released | freigegeben | validé) printed: 09.01.2025

5.2. Defining of the installation area

Cartridge connection (fully sunken)

Note:

- Dimensions in mm
- Observe max. tightening torque of the screw (see **operating instructions Type 6164** ▶)
- Refer to chapter **“8. Product design and assembly”** on page 10 for more information.

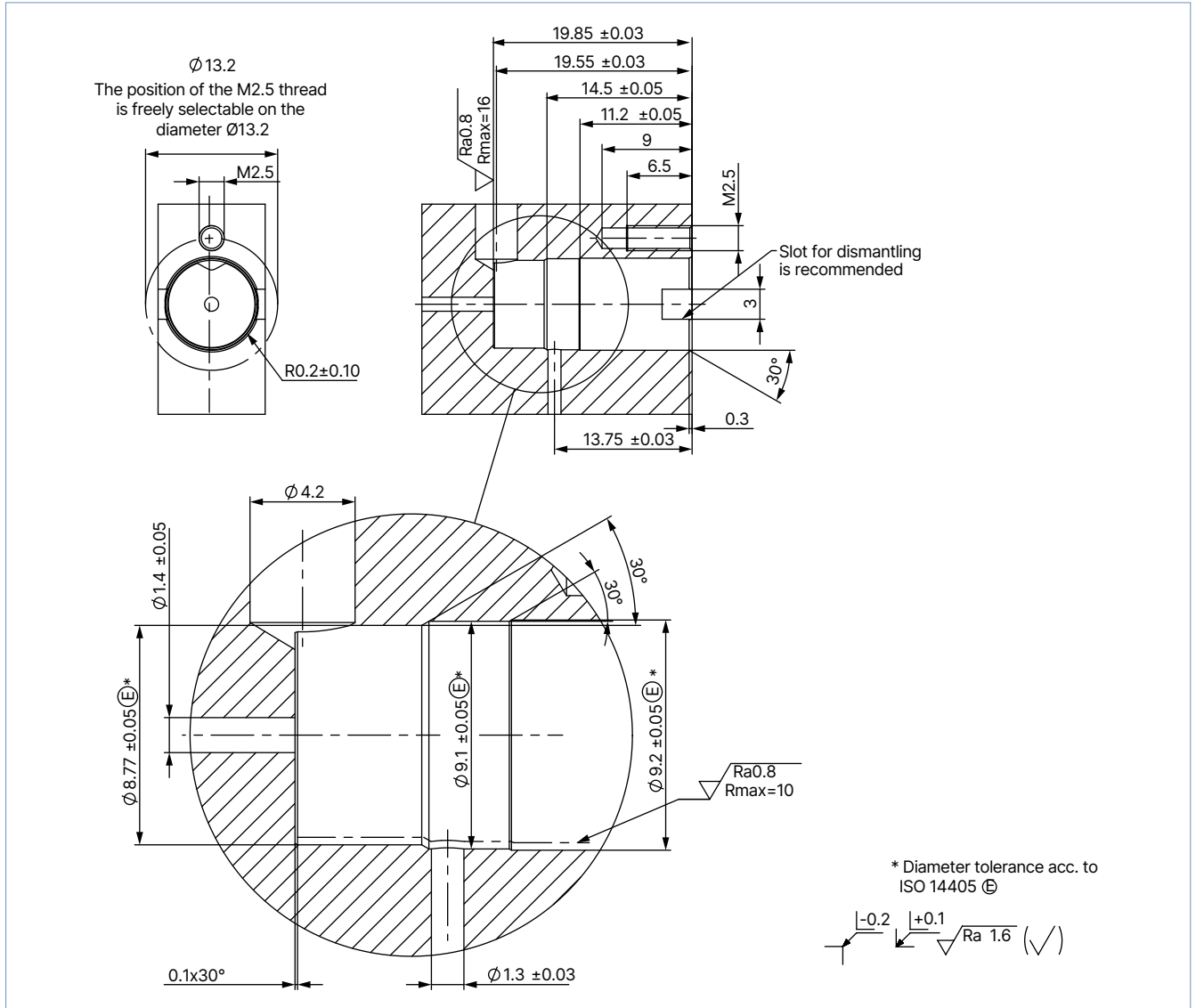

DTS 1000257619 EN Version: P Status: RL (released | freigegeben | validé) printed: 09.01.2025

Cartridge connection (half sunken)

Note:

- Dimensions in mm
- The mounting bracket set is required for installation, see "10.5. Ordering chart accessories" on page 14.
- Refer to chapter "8. Product design and assembly" on page 10 for more information.

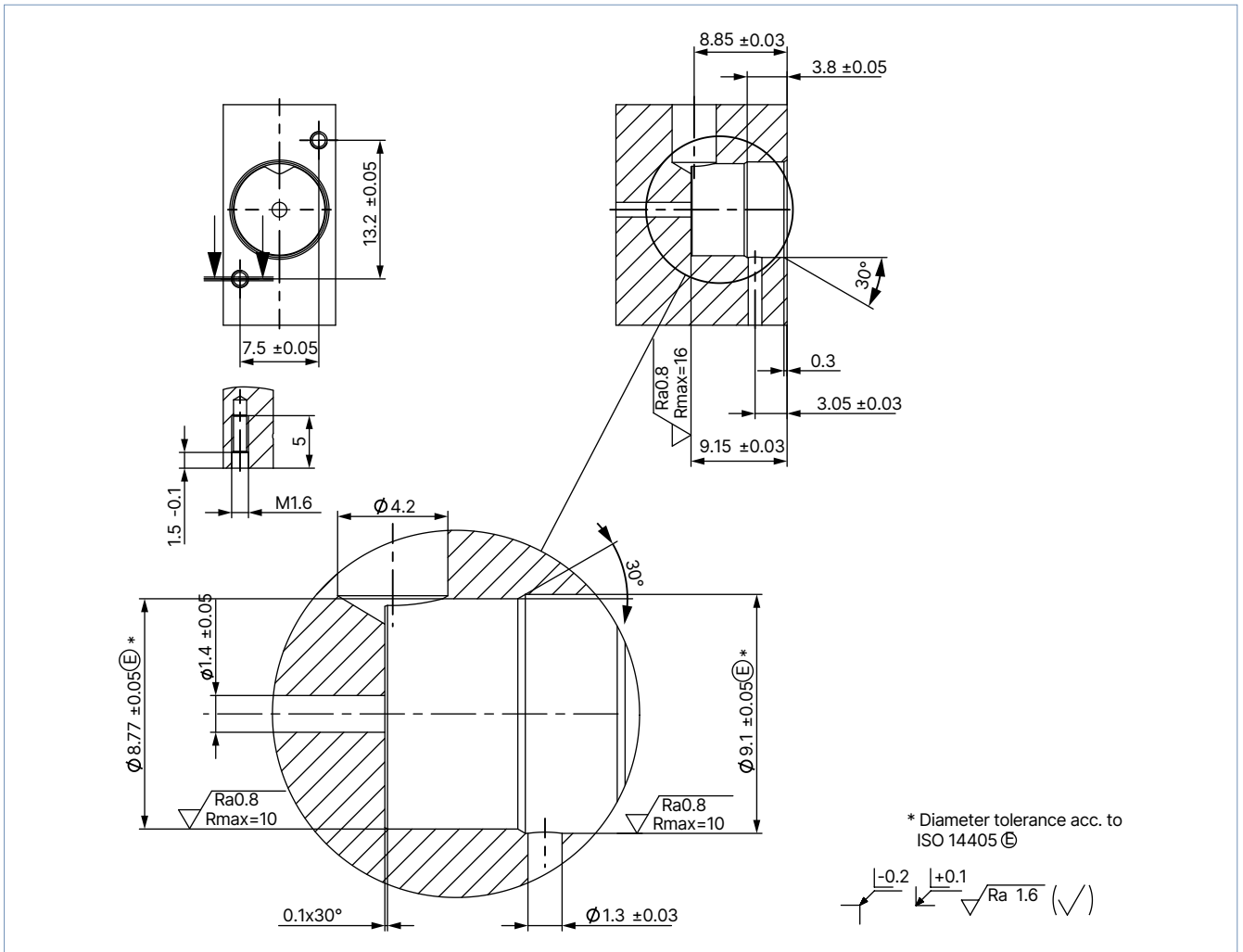

DTS 1000257619 EN Version: P Status: RL (released | freigegeben | validé) printed: 09.01.2025

6. Device/Process connections

6.1. Pin assignment standard version

Note:

- The pin assignment (marked No. 1, 2 and 3 in the drawings) depends on the circuit function. In the table, compare the respective pin assignment with the corresponding circuit function.
- The polarity must be observed only in the Ex version.

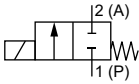
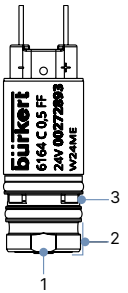
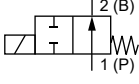
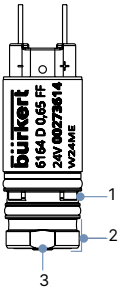
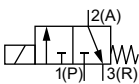
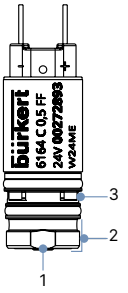
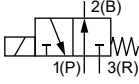
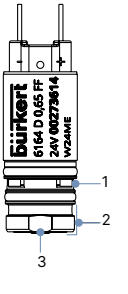
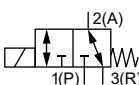
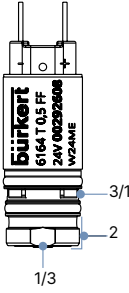
Circuit functions	Port 1	Port 2	Port 3	3-way
<p>CF A 2/2-way solenoid valve Direct-acting Normally closed</p>  <p>(same valve as for circuit function C by blind connection to 3)</p>	Pressure port	Working port	Blind	
<p>CF B 2/2-way solenoid valve Direct-acting Normally open</p>  <p>(same valve as for circuit function D by blind connection to 3)</p>	Pressure port	Working port	Blind	
<p>CF C 3/2-way solenoid valve Direct-acting Normally closed</p>  <p>(applicable to circuit function A by using blind connectors on 3)</p>	Pressure port	Working port	Ventilation	
<p>CF D 3/2-way solenoid valve Direct-acting Normally open</p>  <p>(applicable to circuit function B by using blind connectors on 3)</p>	Pressure port	Working port	Ventilation	
<p>CF T 3/2-way solenoid valve Direct-acting Flow direction optional Normally closed</p> 	Pressure port	Working port	Ventilation	

DTS 1000257619 EN Version: P Status: RL (released | freigegeben | validé) printed: 09.01.2025

7. Performance specifications

7.1. Electrical data ATEX/IECEX i version

Note:

- The valve is intended for operation at 24 V/DC outputs via the intermedia switching of a corresponding intrinsically safe operating resource (isolating module or barrier). Refer to **operating instructions Type 6164** ▶ for the permitted maximum values/value pairs.
- Type of protection:
 BVS 16 ATEX E 088 X: II 2G Ex ib IIC T6...T4 Gb & II 2D Ex ib IIIB T155 °C Db
 IECEx BVS 16.0053 X: Ex ib IIC T6...T4 Gb & Ex ib IIIB T155 °C Db

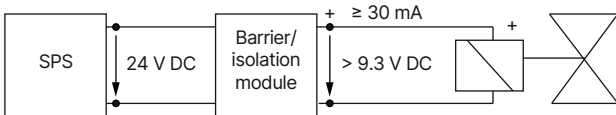

Version	Resistance at +20 °C ± 4 %	Minimum terminal voltage	Minimum current
	[Ohm]	[V]	[mA]
Version for use with 300 Ω supply module	320	9.3	29
High-resistance version	510	11.7	23

8. Product design and assembly

8.1. Application examples

Single block with Cartridge	Cartridge installation position
Fully sunken multi-manifold	Semi-sunken multi-manifold

DTS 1000257619 EN Version: P Status: RL (released | freigegeben | valide) printed: 09.01.2025

9. Product accessories

9.1. Single manifold fully sunken

Note:

- Dimensions in mm
- Observe maximum tightening torque of the screw (see **operating instructions Type 6164** ▶)

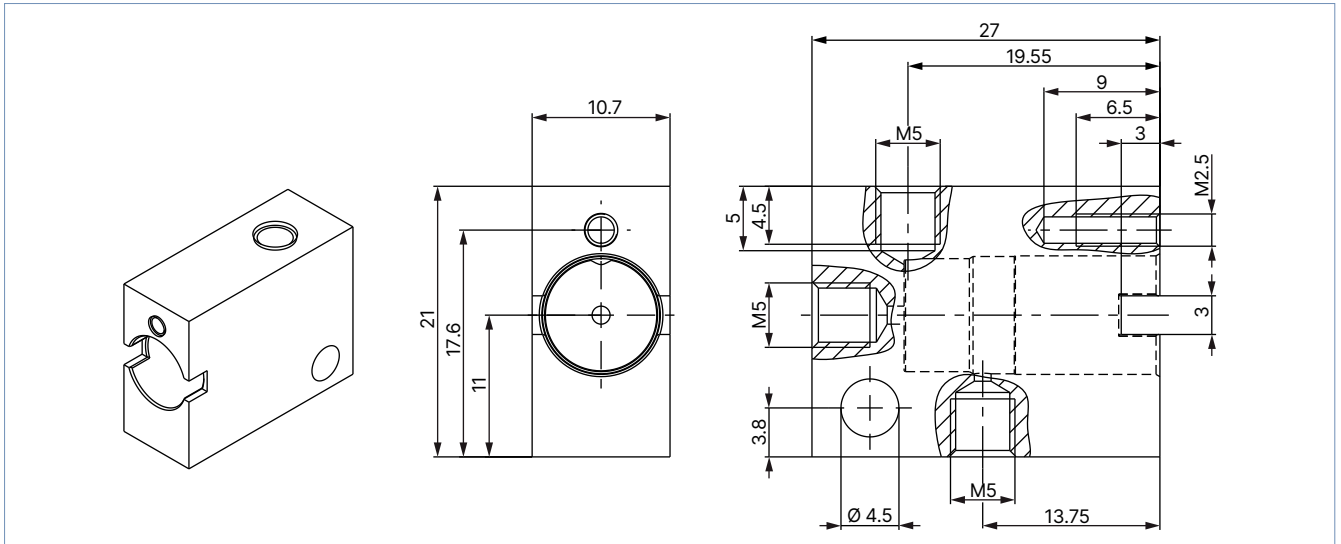

Description	Article no.
Manifold 1 place, brass	695913

10. Ordering information

10.1. Bürkert eShop



Bürkert eShop – Easy ordering and quick delivery

You want to find your desired Bürkert product or spare part quickly and order directly? Our online shop is available for you 24/7. Sign up and enjoy all the benefits.

[Order online now](#)

10.2. Bürkert product filter



Bürkert product filter – Get quickly to the right product

You want to select products comfortably based on your technical requirements? Use the Bürkert product filter and find suitable articles for your application quickly and easily.

[Try out our product filter](#)

10.3. Bürkert Product Enquiry Form

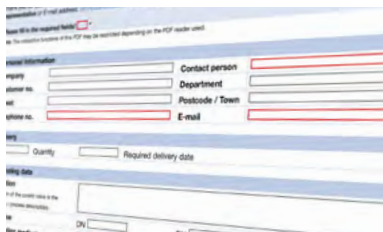

Bürkert Product Enquiry Form – Your enquiry quickly and compactly

Would you like to make a specific product enquiry based on your technical requirements? Use our Product Enquiry Form for this purpose. There you will find all the relevant information for your Bürkert contact. This will enable us to provide you with the best possible advice.

[Fill out the form now](#)

DTS 1000257619 EN Version: P Status: RL (released | freigegeben | validé) printed: 09.01.2025

10.4. Ordering chart

Standard version

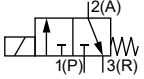
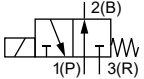
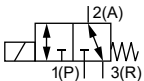
Circuit functions	Port connection	Orifice ventilation	Orifice ventilation	Q _{Nn} value	Q _{Nn} value	Voltage/ Frequency	Nominal power	Pressure range ^{2.)}	Article no. with connection pins		
		1→2	2→3	air ^{1.)}	air ^{1.)}						
		[mm]	[mm]	[l/min]	[l/min]						
CF C 3/2-way solenoid valve Direct-acting Normally closed 	Bürkert cartridge connection diagram	0.5	0.65	6	9.55	12/DC	0.7	Vac...9	273612		
						24/DC		Vac...9	272893		
						24/DC		2.5...10	281022		
				0.8	1.1	16	20	24/DC	2.8/0.3 ^{3.)}	Vac...7.5	285701
				1.0	1.1	20	20			Vac...5	285700
		1.2	1.1	25	22			Vac...1.5	272894		
CF D 3/2-way solenoid valve Direct-acting Normally open 	Bürkert cartridge connection diagram	0.65	0.5	6.5	6	12/DC	0.7	Vac...6	273615		
						24/DC			273614		
CFT 3/2-way solenoid valve Direct-acting Flow direction optional Normally closed 	Bürkert cartridge connection diagram	0.5	0.65	6	6	24/DC	0.7	Vac...4	292608		

1.) Measurement at + 20 °C, 6 bar at valve inlet and 1 bar differential pressure
 2.) Technical vacuum (- 0.8 bar)
 3.) External power reduction electronics assembly required

DTS 1000257619 EN Version: P Status: RL (released | freigegeben | validé) printed: 09.01.2025

ATEX/IECEX i version

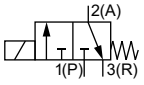
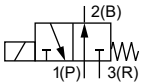
Circuit functions	Port connection	Orifice ventilation 1→2	Orifice ventilation 2→3	Q _{Nn} value air ^{1.)} 1→2	Q _{Nn} value air ^{1.)} 2→3	Pressure range ^{2.)}	Resist-ance at 20 °C ± 4 %	Min. holding current	Article no. with connection pins
		[mm]	[mm]	[l/min]	[l/min]		[Ω]		
CF C 3/2-way solenoid valve Direct-acting Normally closed 	Bürkert cartridge connection diagram	0.5	0.65	6	9.5	Vac...6	320	29	289027
							510	23	289028
CF D 3/2-way solenoid valve Direct-acting Normally open 	Bürkert cartridge connection diagram	0.65	0.5	6.5	6	Vac...4	320	29	o. r.

o. r. = on request

1.) Measurement at + 20 °C, 6 bar at valve inlet and 1 bar differential pressure

2.) Technical vacuum (- 0.8 bar)

Further versions on request

	Additional Leads version up to 300 mm		Voltage Voltages 9 V, 6 V, 3 V
	Approval Further information can be found in chapter "3. Approvals and conformities" on page 4.		







10.5. Ordering chart accessories

Single manifold fully sunken

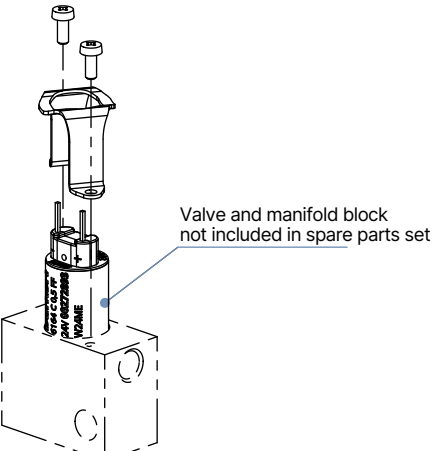
Ordering information and dimensions of the single manifold fully sunken can be found in chapter **"9.1. Single manifold fully sunken"** on page 11.

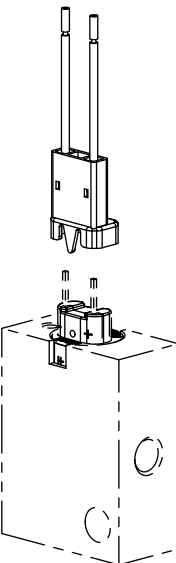
DTS 1000257619 EN Version: P Status: RL (released | freigegeben | validé) printed: 09.01.2025

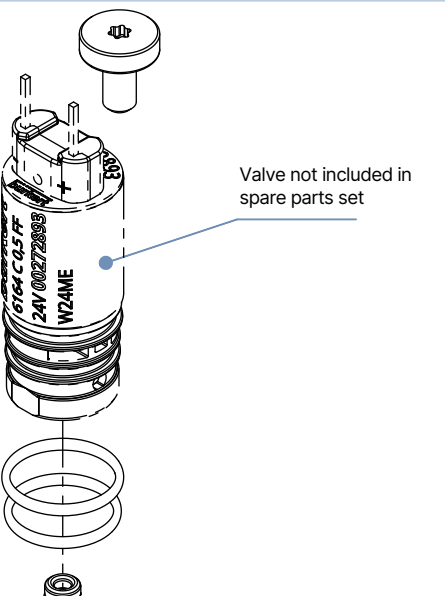
Further accessories

Accessories	Description	Article no.
	<p>Mounting bracket set for semi-recessed mounting for Type 6164</p> <p>Scope of delivery:</p> <ul style="list-style-type: none"> • 2 x fixing screws M1.6×5, stainless steel A2 • 1 x mounting bracket 1.4310 	<p>696032 </p>
	<p>Plug for Type 6164 with two PVC wires, AWG 24, length 300 mm</p>	<p>695951 </p>
	<p>Spare parts set for Type 6164</p> <p>Scope of delivery:</p> <ul style="list-style-type: none"> • 1 x cheese head screw with internal TORX T8 M2.5×5, stainless steel A2 • 2 x O-ring large, FKM • 1 x O-ring small, FKM 	<p>696033 </p>

DTS 1000257619 EN Version: P Status: RL (released | freigegeben | valide) printed: 09.01.2025