



Electromotive T-diaphragm valve (on/off)

- Safety position through energy storage
- Adjustable driving force
- Diagnostics functions and fieldbus connection
- Wetted surfaces in Ra ≤ 0.38 µm...1.6 µm (optionally electropolished)
- Available in nominal diameters DN 06...DN 100

Product variants described in the data sheet may differ from the product presentation and description.

Can be combined with

	Type SV02 Diaphragms	▶
	Type ME61 EDIP process display	▶
	Type ME63 Industrial Ethernet gateway, IP65/IP67/IP69k	▶
	Type ME43 Fieldbus gateway	▶
	Type 8098 FLOWave SAW flowmeter	▶

Type description

The externally controlled Type 3324 diaphragm valve consists of an electrically controlled linear actuator (on/off), a diaphragm and a T-valve body. The electric actuator with ball screw ensures usage under hygienic or aggressive ambient conditions. The flow-optimised valve body with minimum dead space enables high flow rates and a wide range of possible applications. In the event of a power failure, the safety position is guaranteed by an optional energy storage device. The position is displayed by means of a 360° LED light ring. To protect the diaphragm the actuator has a drive force adjustment. A correspondingly high IP protection IP65/IP67 ensures adequate splash protection. The electromotive actuator of the T-diaphragm valve with ball screw moves to the desired end position at a particularly high speed up to 4 mm/s. In addition the valve is also equipped with a mechanical position indicator and corresponding explosion protection ATEX/II 3G Ex ec IIC T4 Gc/II 3D Ex tc IIIC T135 °C Dc.

DTS 1000516529 EN Version: N Status: RL (released | freigegeben | valide) printed: 28.04.2026

Table of contents

1. General technical data	3
<hr/>	
2. Approvals and conformities	5
2.1. General notes	5
2.2. Conformity	5
2.3. Standards	5
2.4. Explosion protection.....	5
2.5. North America (USA/Canada)	5
2.6. Foods and beverages/Hygiene	6
2.7. Others	6
Oxygen	6
<hr/>	
3. Materials	7
3.1. Bürkert resistApp	7
3.2. Material specifications	7
3.3. Example of available diaphragm materials.....	8
<hr/>	
4. Dimensions	8
4.1. Actuator	8
AG2.....	8
AG3.....	9
4.2. T-body with welded connection	10
4.3. T-body with clamp connection	14
<hr/>	
5. Product connections	15
5.1. Electrical connection.....	15
Description of circular plug-in connectors.....	15
Circular plug-in connector with pin assignment	17
<hr/>	
6. Performance specifications	18
6.1. Operating limits	18
Medium pressure	18
Operating limits for ambient and medium temperature.....	18
6.2. Electrical control and interfaces.....	20
Interface diagram	20
<hr/>	
7. Product design and assembly	21
7.1. Product features	21
7.2. Product assembly	23
Design of electromotive diaphragm valve Type 3324 AG2	23
Design of electromotive diaphragm valve Type 3324 AG3	24
<hr/>	
8. Ordering information	25
8.1. Bürkert eShop	25
8.2. Bürkert product filter	25
8.3. Bürkert Product Enquiry Form.....	25
8.4. Ordering chart accessories.....	26
Standard accessories	26
Accessories cable.....	26
Bürkert accessories.....	26

DTS 1000516529 EN Version: N Status: RL (released | freigegeben | valide) printed: 28.04.2026

1. General technical data

Note:

- AG2: actuator size 2 with a nominal force of 1300 or 2500 N for diaphragm size 8...40
- AG3: actuator size 3 with a nominal force of 7700 or 11500 N for diaphragm size 40...100

Product properties	
Dimensions	Further information can be found in chapter "4. Dimensions" on page 8.
Material	
Block body (VH) ¹⁾	Stainless steel block material 1.4435 according to DIN EN 10088 and 316L according to ASTM A479/A479M
Block body (VI) ¹⁾	Stainless steel block material 1.4435 according to DIN EN 10088 and 316L according to ASME BPE (Table MM- 2.1.1, Ed. 2024)
Design	Diaphragm on/off valve
Diaphragm	EPDM (AD) ¹⁾ , PTFE/EPDM (EA) ¹⁾ , Advanced PTFE/EPDM (EU) ¹⁾ , laminate of GYLON® and EPDM (ER) ¹⁾
Diaphragm size	8...100
Standard surface quality ²⁾	
Block body (VI etc.) ¹⁾	Internally electrically polished: Ra ≤ 0,38 µm (NO17) ¹⁾ (ASME BPE SF4/DIN HE4) (externally surface electrically polished) Internally mechanically polished: Ra ≤ 0,5 µm (NO14) ¹⁾ (ASME BPE SF1) (externally surface mechanically machined)
Safety setting in case of power failure	With energy storage SAFEPOS energy-pack: open, closed or freely programmable position Without energy storage SAFEPOS energy-pack: blocked in last position
Service life of energy storage SAFEPOS energy-pack	Up to 10 years (depending on operating conditions)
Performance data	
Closing time	1.5...4.5 s, depending on diaphragm size
Travel speed	4 mm/s (for AG2 actuator force 2500 N) 3 mm/s (for AG3 actuator force 11500 N)
Electrical data	
Operating voltage	24 V DC ± 10 % (maximum residual ripple 10 %)
Operating current ³⁾	AG2: maximum 3 A (at maximum load and including 1 A charging current of the optional energy storage SAFEPOS energy-pack). At minimum operating temperature additionally 2 A AG3: maximum 5 A (at maximum load and including charging current of the optional energy storage SAFEPOS energy-pack). At minimum operating temperature additionally 6 A
Protection class (DIN EN 61140)	III
Duty cycle	100 %
Standby consumption ³⁾	2...5 W
Communication and control	
Standard signal (binary)	0...5 V (log „0“) 10...30 V (log „1“)
Fieldbus (digital)	Bürkert system bus (bÜS) CANopen (optional) EtherNet/IP, PROFINET, Modbus TCP, EtherCAT (optional via integrated gateway)
Medium data	
Operating medium	Neutral gases and fluids, highly purified, sterile, aggressive or abrasive mediums (see chemical resistance chart ►)
Medium temperature	
EPDM (AD) ¹⁾	- 10...+ 143 °C (steam sterilisation + 150 °C for 60 min)
PTFE/EPDM (EA) ¹⁾	- 10...+ 130 °C (steam sterilisation + 140 °C for 60 min)
Advanced PTFE/EPDM (EU) ¹⁾	- 5...+ 143 °C (steam sterilisation + 150 °C for 60 min)
Laminate of GYLON® and EPDM (ER) ¹⁾	- 5...+ 130 °C (steam sterilisation + 140 °C for 60 min)

Product connections

Port connection ^{2.)}

Nominal diameter DN 06...DN 40 (1/8"... 1 1/2")

Stainless steel body

Welded connection ^{2.)} DIN EN ISO 1127 / ISO 4200 / DIN 11866 series B
 DIN 11850 - 2 / DIN 11866 series A / DIN EN 10357 series A
 ASME BPE / DIN 11866 series C

Clamp connection ^{2.)} DIN 32676 series A (DIN pipe)
 DIN 32676 series B (ISO pipe)
 ASME BPE

Electrical connection

Actuator Terminal strip with cable bushing (only AG2), 2 x M20 or 2 x M12 circular plugs, 5-pin and 8-pin
 Fieldbus gateway 2 x M12 circular sockets, 4-pin (only with Industrial Ethernet)
 Further information can be found in chapter "5. Product connections" on page 15.

Approvals and conformities

Further information can be found in chapter "2. Approvals and conformities" on page 5.

Detergent resistance According to Ecolab test method: F&E/P3-E No. 40 - 1

Environment and installation

Ambient temperature -10 °C...+ 65 °C ^{4.)} (without display)
 -10 °C...+ 60 °C ^{4.)} (with display)
 -10 °C...+ 55 °C ^{4.)} (with energy storage SAFEPOS energy-pack)

Degree of protection IP65/IP67 (DIN EN 60529), NEMA 4X (only AG2)

Vibration and shock resistance

Vibration, sinusoidal 5 g (IEC 60068 - 2 - 6 Test Fc)

Shock, mechanical 50 g (IEC 60068 - 2 - 27 Test Ea)

Installation position Any, preferably with actuator upright

1.) This information is part of the product key (see "8.3. Bürkert Product Enquiry Form" on page 25).

2.) Further cable connections are available on request.

3.) All values relate to a supply voltage of 24 V at + 25 °C.

4.) Depends on medium temperature, see chapter "Operating limits for ambient and medium temperature" on page 18

2. Approvals and conformities

2.1. General notes

- The approvals and conformities listed below must be stated when making enquiries. This is the only way to ensure that the product complies with all required specifications.
- Not all available variants can be supplied with the below mentioned approvals or conformities.



2.2. Conformity

In accordance with the Declaration of Conformity, the product is compliant with the EU Directives.

2.3. Standards

The applied standards which are used to demonstrate compliance with the EU Directives are listed in the EU-Type Examination Certificate and/or the EU Declaration of Conformity.

2.4. Explosion protection

Approval	Description
 	<p>Optional: Explosion protection (valid for the variable code PX48) As a category 3 device suitable for zone 2/22.</p> <p>ATEX: BVS 17 ATEX E 117 X II 3G Ex ec IIC T4 Gc II 3D Ex tc IIIC T135 °C Dc</p> <p>IECEX: IECEX BVS 17.0100X Ex ec IIC T4 Gc Ex tc IIIC T135 °C Dc</p>

2.5. North America (USA/Canada)

Approval	Description
	<p>Optional: Actuators UL Listed for the USA and Canada (valid for the variable code PU11) The actuators are UL Listed for the USA and Canada according to:</p> <ul style="list-style-type: none"> • UL 61010-1 (ELECTRICAL EQUIPMENT FOR MEASUREMENT, CONTROL, AND LABORATORY USE – Part 1: General Requirements) • CAN/CSA-C22.2 No. 61010-1

2.6. Foods and beverages/Hygiene

Conformity	Description
	3-A Sanitary Standards Inc. (valid for the variable code PE05) The products comply with 3-A Sanitary Standards Inc (3-A SSI) as per certificate.
FDA	FDA – Code of Federal Regulations The diaphragms made of EPDM (AD), PTFE/EPDM (EA), Advanced PTFE/EPDM (EU) and laminate of GYLON® and EPDM (ER) comply with the Code of Federal Regulations published by the FDA (Food and Drug Administration, USA).
USP	United States Pharmacopeial Convention (USP) The diaphragms made of EPDM (AD), PTFE/EPDM (EA), Advanced PTFE/EPDM (EU) and laminate of GYLON® and EPDM (ER) are tested according to USP Class VI.
	EC Regulation 1935/2004 of the European Parliament and of the Council The diaphragms made of EPDM (AD), PTFE/EPDM (EA), Advanced PTFE/EPDM (EU) and laminate of GYLON® and EPDM (ER) are suitable for use with food and beverages (according to EC Regulation 1935/2004/EC).

2.7. Others

Oxygen

Conformity	Description
	Optional: Suitability for oxygen (valid for the variable code NL02) The products are suitable for use with gaseous oxygen, according to the manufacturer’s declaration.

DTS 1000516529 EN Version: N Status: RL (released | freigegeben | valide) printed: 28.04.2026

3. Materials

3.1. Bürkert resistApp

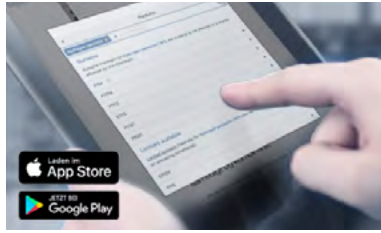

Bürkert resistApp – Chemical resistance chart

You want to ensure the reliability and durability of the materials in your individual application case? Verify your combination of media and materials on our website or in our resistApp.

[Start chemical resistance check](#)

3.2. Material specifications

Note:

The exemplary representation may differ from the actual product.

AG2

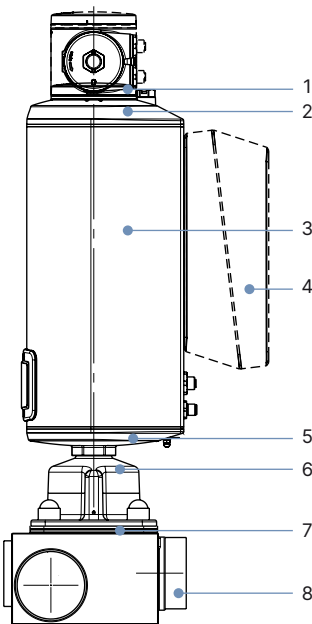

No.	Component	Material
1	Blind cover	PPS (standard), stainless steel 1.4301 (for ATEX/IECEX)
2	Actuator cover	PPS
3	Actuator housing	Powder-coated aluminium
5	Actuator base	PPS
6	Interface	Stainless steel 1.4308
7	Diaphragm	EPDM (AD) PTFE/EPDM (EA) Advanced PTFE/EPDM (EU) Laminate of GYLON® and EPDM (ER)
8	Valve body	See "1. General technical data" on page 3

AG3

No.	Component	Material
1	Blind cover	PPS (standard), stainless steel 1.4301 (for ATEX/IECEX)
2	Actuator cover	PC
3	Actuator housing	Powder-coated aluminium
4	Energy storage SAFEPOS energy-pack housing	PC
5	Actuator base	Stainless steel 1.4308
6	Interface	Stainless steel 1.4470
7	Diaphragm	EPDM (AD) PTFE/EPDM (EA) Advanced PTFE/EPDM (EU) Laminate of GYLON® and EPDM (ER)
8	Valve body	See "1. General technical data" on page 3

DTS 1000516529 EN Version: N Status: RL (released | freigegeben | valide) printed: 28.04.2026

3.3. Example of available diaphragm materials

The diaphragms have been developed to meet the unique challenges of hygienic and sterile requirements. Bürkert offers diaphragms with precise material composition and high accuracy. Bürkert diaphragms are available in a wide range of materials which have been tested and proven in applications in the food and beverage, biotechnology, pharmaceutical and cosmetics industries. The diaphragms are tested during development and production to ensure reliability under difficult process conditions.



- EPDM (AD)
- PTFE/EPDM (EA)
- Advanced PTFE/EPDM (EU)
- Laminate of GYLON® and EPDM (ER)

For further information please refer to our flyer “Diaphragm competence for hygienic applications” on our [website](#) ▶.

4. Dimensions

4.1. Actuator

AG2

Note:

Dimensions in mm, unless otherwise stated

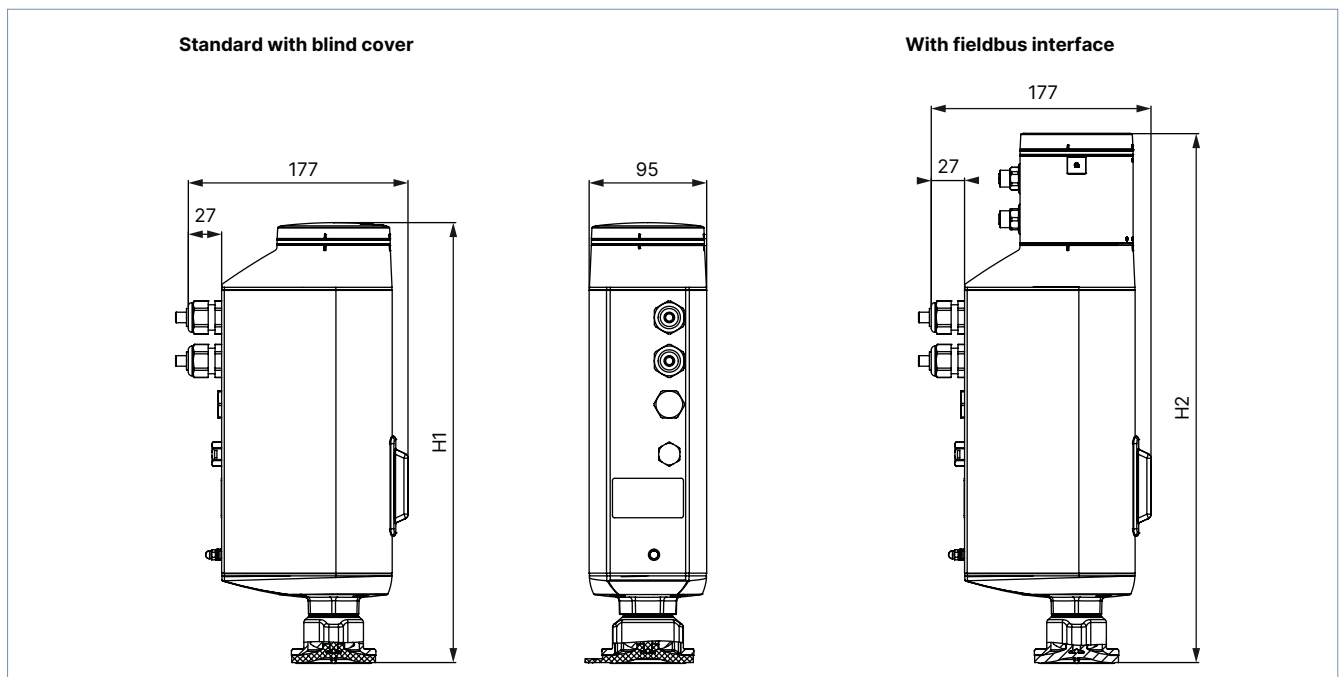

Diaphragm size	Height	
	H1 Standard variant	H2 Fieldbus variant (KOMM ≠ G, N, L)
8	342	414
15	345	418
20	350	422
25	355	426
32	365	436
40	370	442

AG3

Note:

Dimensions in mm, unless otherwise stated

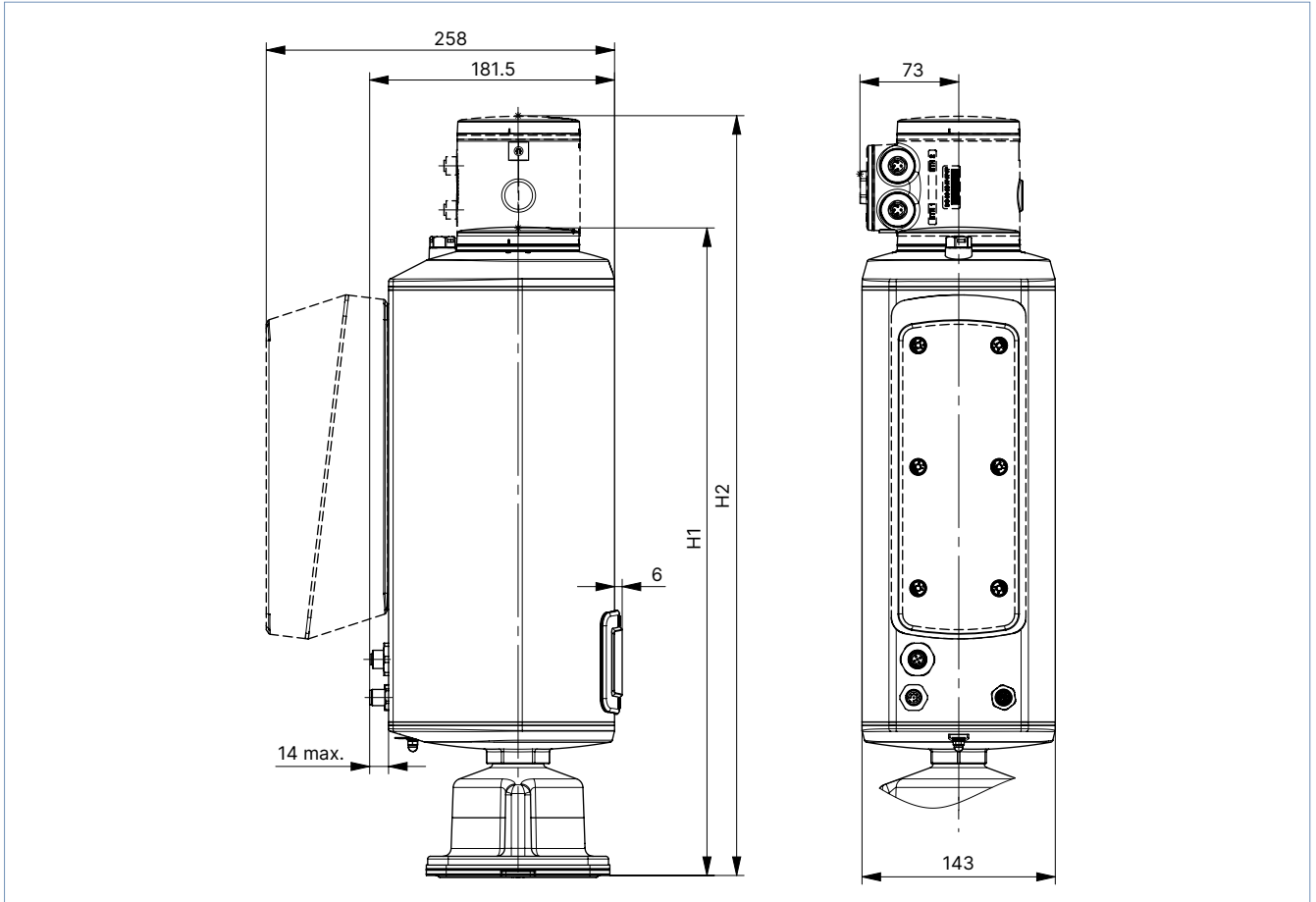

Diaphragm size	Height	
	H1 Standard variant	H2 Fieldbus variant (KOMM ≠ G, N, L)
40	452	523
50	462	533
65	477	548
80	479	550
100	482	553

4.2. T-body with welded connection

Note:

Dimensions in mm, unless otherwise stated

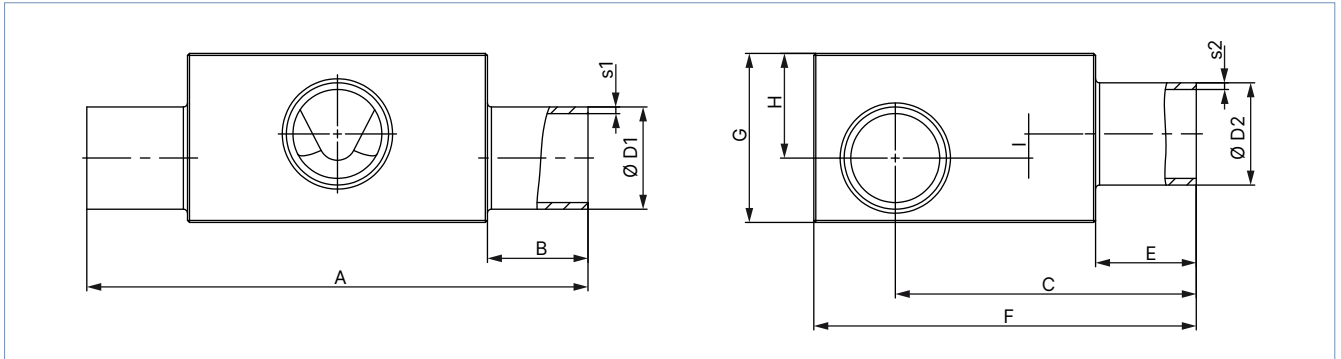

Diaphragm size	Port 1 – Port 2 DN	Ø D1	s1	Ø D2	s2	A	B	C	E	F	G	H	I	Product key ¹⁾ (Port 1 – Port 2)
DIN EN ISO 1127 / ISO 4200 / DIN 11866 series B														
8	8...8	13.5	1.6	13.5	1.6	78.0	20	47.2	20	60	24	15	5.0	SA40-SA40
	10...8	17.2		13.5		78.0		49.00		60	29	18	8.0	SA41-SA40
	10...10	17.2		17.2		78.0		49.00		60	29	18	8.0	SA41-SA41
	15...8	21.3		13.5		78.0		51.1		64	34	21	11.0	SA42-SA40
	15...10	21.3		17.2		78.0		51.1		64	34	21	11.0	SA42-SA41
	20...8	26.9		13.5		88.0		25		53.9	70	38	23	13.0
	20...10	26.9	17.2	88.0	53.9	70	38		23	13.0	SA43-SA41			
	25...8	33.7	2.0	13.5	88.0	53.9	76	45	26	16.0	SA44-SA40			
	25...10	33.7		17.2	88.0	53.9	76	45	26	16.0	SA44-SA41			
	32...8	42.4		13.5	88.0	60.50	84	52	29	19.0	SA45-SA40			
	32...10	42.4		17.2	88.0	61.20	84	52	29	19.0	SA45-SA41			
	40...8	48.3		13.5	88.0	64.2	90	57	31	21.0	SA46-SA40			
	40...10	48.3		17.2	88.0	64.2	90	57	31	20.0	SA46-SA41			
	50...8	60.3	2.3	13.5	30	98.0	70.2	102	66	34	24.0	SA47-SA40		
	50...10	60.3		17.2		98.0	70.2	102	66	34	24.0	SA47-SA41		
	65...8	76.1		13.5		98.0	78.1	118	80	40	30.0	SA48-SA40		
	80...8	88.9		13.5		98.0	84.2	131	92	46	36.0	SA49-SA40		
	80...10	88.9		17.2		98.0	84.2	131	92	46	35.0	SA49-SA41		

DTS 1000516529 EN Version: N Status: RL (released | freigegeben | valide) printed: 28.04.2026

DTS 1000516529 EN Version: N Status: RL (released | freigegeben | valide) printed: 28.04.2026

Diaphragm size	Port 1 – Port 2 DN	Ø D1	s1	Ø D2	s2	A	B	C	E	F	G	H	I	Product key ¹⁾ (Port 1 – Port 2)				
15	8...8	13.5	1.6	13.5	1.6	93.0	20	52.05	20	70	27	17	4.5	SA40-SA40				
	10...8	17.2		13.5		93.0		53.9		70	31	18	4.5	SA41-SA40				
	10...10	17.2		17.2		93.0		54.9		70	28	16	2.5	SA41-SA41				
	15...8	21.3		13.5		93.0		57		71	34.5	21	7.5	SA42-SA40				
	15...15	21.3		21.3		93.0		56		71	35	21	6.5	SA42-SA42				
	20...8	26.9		13.5		103.0		25		59.8	76	41	25	11.5	SA43-SA40			
	20...10	26.9		17.2		103.0				59.8	78	42	25	11.5	SA43-SA41			
	20...15	26.9		21.3		103.0				59.8	78	42	25	11.5	SA43-SA42			
	25...10	33.7		2.0		17.2				103.0	63	83	48	28	14.5	SA44-SA41		
	25...15	33.7				21.3				103.0	62.8	83	47	28	14.5	SA44-SA42		
	32...8	42.4				13.5				103.0	67.1	91	56	32	18.5	SA45-SA40		
	32...10	42.4				17.2		103.0		67.1	91	56	32	18.5	SA45-SA41			
	32...15	42.4				21.3		103.0		67.1	91	56	32	18.5	SA45-SA42			
	40...8	48.3				13.5		103.0		70.1	97	63	35	21.5	SA46-SA40			
	40...10	48.3	17.2		103.0	70.1	97	63	35	21.5	SA46-SA41							
	40...15	48.3	21.3		103.0	70.1	97	63	35	21.5	SA46-SA42							
	50...8	60.3	13.5	113.0	30	76.1	109	72	38	24.5	SA47-SA40							
	50...10	60.3	17.2	113.0		76.1	109	72	38	24.5	SA47-SA41							
	50...15	60.3	21.3	113.0		76.1	109	72	38	24.5	SA47-SA42							
	65...8	76.1	13.5	113.0		84	125	85	44	30.5	SA48-SA40							
	65...15	76.1	21.3	113.0		84	125	85	44	30.5	SA48-SA42							
	80...8	88.9	2.3	13.5		113.0	90.1	140	99	52	38.5	SA49-SA40						
	80...10	88.9		17.2	113.0	90.1	137	94	47	33.5	SA49-SA41							
	80...15	88.9		21.3	113.0	90.1	137	94	47	33.5	SA49-SA42							
	100...15	114.3		21.3	113.0	102.8	163	120	60	46.5	SA39-SA42							
	20	20...20		26.9	1.6	26.9	1.6	114.0	25	70.3	25	87	40	24	6.0	SA43-SA43		
		25...20		33.7	2.0	26.9		114.0		73.3		94	48	28	10.0	SA44-SA43		
		32...20	42.4	26.9	114.0	78.6		102		57		33	15.0	SA45-SA43				
40...20		48.3	26.9	114.0	80.6	108		63		35		17.0	SA46-SA43					
50...20		60.3	26.9	124.0	30	87		120.8	72	39		21.0	SA47-SA43					
65...20		76.1	26.9	124.0		94.5		136	86	45		27.0	SA48-SA43					
80...20		88.9	2.3	26.9		124.0		100.6	148	94		47	29.0	SA49-SA43				
100...20		114.3		26.9		124.0		113.3	173	120		60	42.0	SA39-SA43				
25		25...25	33.7	2.0		33.7		2.0	124.5	25		78.6	25	98	53	33	13.0	SA44-SA44
		32...25	42.4			124.5			82.9			107		62	38	18.0	SA45-SA44	
	40...25	48.3	124.5		85.9	114	69		41		21.0	SA46-SA44						
	50...25	60.3	134.5		30	81.9	125		78		45	25.0		SA47-SA44				
	65...25	76.1	134.5			99.8	142		94	52	32.0	SA48-SA44						
	80...25	88.9	2.3			33.7	134.5		105.9	153	101	54		34.0	SA49-SA44			
	150...25	168.3				2.6	33.7		134.5	145.3	232	174		87	67.0	SA69-SA44		
	40	32...32	42.4		2.0	42.4	2.0		152.0	25	98.00	25		122	62	38	9.4	SA45-SA45
40...32		48.3	152.0	100		128		68	41		12.4		SA46-SA45					
40...40		48.3	152.0	100		128		68	41		12.4		SA46-SA46					
50...32		60.3	162.0	30		106		140	82		48		19.4	SA47-SA45				
50...40		60.3	162.0			106		140	82		48		19.4	SA47-SA46				
65...40		76.1	162.0			113.9		155	97		55		26.4	SA48-SA46				
80...32		88.9	2.3			42.4		162.0	120	168	108		60	31.4	SA49-SA45			
80...40		88.9				48.3		162.0	120	168	108		60	31.4	SA49-SA46			
100...32		114.3				42.4		162.0	132.7	193	129		68	39.4	SA39-SA45			
100...40		114.3		48.3		162.0		132.7	193	129	68		39.4	SA39-SA46				
50		50...50	60.3	2.0		60.3		2.0	188.0	30	120.2		30	154	82	48	12.5	SA47-SA47
		65...50	76.1			188.0			128.1		170			100	56	20.5	SA48-SA47	
	80...50	88.9	2.3		60.3	188.0	134.2		183		110	61		25.5	SA49-SA47			
	100...50	114.3			60.3	188.0	146.9		208		131	70		34.5	SA39-SA47			
	150...50	168.3			2.6	60.3	188.0		173.6		261	176		88	52.5	SA69-SA47		

Diaphragm size	Port 1 – Port 2 DN	Ø D1	s1	Ø D2	s2	A	B	C	E	F	G	H	I	Product key ¹⁾ (Port 1 – Port 2)
65	65...65	76.1	2.0	76.1	2.0	210	30	144.4	30	186	97	55	12.9	SA48-SA48
	80...65	88.9	2.3	76.1		210		148.7		197	111	63	20.5	SA49-SA48
	100...65	114.3		76.1		210		161.4		222	135	74	31.5	SA39-SA48
80	80...80	88.9	2.3	88.9	2.3	255	30	163.1	30	212	119	71	20	SA49-SA49
	100...80	114.3		88.9		255		177.8		239	144	83	32	SA39-SA49
100	100	114.3	2.3	114.3	2.3	290	30	209.1	30	270	133	72	8.5	SA39-SA39
DIN 11850 - 2 / DIN 11866 series A / DIN EN 10357 series A														
8	10...10	13.0	1.5	13.0	1.5	78.0	20	47.0	20	60	24	15	5.0	SD40-SD40
	20...10	23.0		13.0		88.0	25	52.0		66	36	22	12.0	SD43-SD40
15	15...15	19.0	1.5	19.0	1.5	93.0	20	55.9	20	70	33	20	6.5	SD42-SD42
	20...15	23.0		19.0		103.0		57.9		72	37	22.5	9	SD43-SD42
	25...15	29.0		19.0		103.0	25	60.9		78	43	26	12.5	SD44-SD42
	32...15	35.0		19.0		103.0		63.9		84	49	29	15.5	SD45-SD42
	40...15	41.0		19.0		103.0		66.9		91	56	31	17.5	SD46-SD42
	50...15	53.0		19.0		113.0	30	72.9		102	65	36	22.5	SD47-SD42
20	20...20	23.0	1.5	23.0	1.5	114.0	25	68.7	25	85	36	21	-	SD43-SD43
	32...20	35.0		23.0		114.0		74.4		95	50	29	11.0	SD45-SD43
	40...20	41.0		23.0		114.0		77.4		101	56	32	14.0	SD46-SD43
25	25...25	29.0	1.5	29.0	1.5	124.5	25	76.7	25	98	48	30	10.0	SD44-SD44
	40...25	41.0		29.0		124.5		82.7		106	61	38	18.0	SD46-SD44
	50...25	53.0		29.0		134.5	30	88.7		120	73	44	24.0	SD47-SD44
40	32...32	35.0	1.5	35.0	1.5	152.0	25	95	25	119	52	32	9	SD45-SD45
	40...40	41.0		41.0		152.0		97.3		121	62	37	8.4	SD46-SD46
	50...40	53.0		41.0		162.0	30	102.8		133	75	45	16.4	SD47-SD46
50	50...50	53.0	1.5	53.0	1.5	188.0	30	117.0	30	147	74	44	8.5	SD47-SD47
65	65...65	70.0	2.0	70.0	2.0	210.0	30	142.0	30	179	89	52	14	SD48-SD48
	80...65	85.0		70.0		210.0		149.5		194	104	59.5	21.5	SD49-SD48
	100...65	104.0		70.0		210.0		-		-	-	-	-	SD50-SD48
80	80...80	85.0	2.0	85.0	2.0	255.0	30	45.0	30	208	112	67	22	SD49-SD49
	100...80	104.0		85.0		250.0		172.1		227	132	77	32	SD50-SD49
100	100	104.0	2.0	104.0	2.0	293.0	30	211.5	30	267	125	70	11	SD50-SD50
ASME BPE / DIN 11866 series C														
8	20...8	19.05	1.65	6.35	0.89	88.0	25	49.90	20	61	32	20	10.0	SA93-SA90
	25...10	25.40		9.53		88.0	25	53.00		68	38	23	13.0	SODF-SA91
	40...8	38.10		6.35		88.0	25	59.40		80	49	28	18.0	SODH-SA90
	50...8	50.80		6.35		98.0	30	65.80		93	59	32	22.0	SODI-SA90
	65...8	63.50		6.35		98.0		72.10		106	70	36	26.0	SODJ-SA90
15	15...15	12.70	1.65	12.70	1.65	93.0	20	53.20	20	70	27	13.5	-	SA92-SA92
	20...15	19.05		12.70		103.0		55.80		70	31	18.5	5.0	SA93-SA92
	25...15	25.40		12.70		103.0		59.00		75	40	24	10.5	SODF-SA92
	40...15	38.10		12.70		103.0	25	65.30		88	54	31	17.5	SODH-SA92
	50...15	50.80		12.70		113.0	30	71.70		100	64	35	21.5	SODI-SA92
	65...15	63.50		12.70		113.0		78.00		113	73	38	24.5	SODJ-SA92
	80...15	76.20		12.70		113.0		84.40		125	84	43	29.5	SODK-SA92
20	20...20	19.05	1.65	19.05	1.65	114	25	66.30	25	85	36	18	-	SA93-SA93
	25...20	25.40		19.05		114		69.20		88	40	24	6.0	SODF-SA93
	40...20	38.10		19.05		114		75.80		98	53	31	13.0	SODH-SA93
	50...20	50.80		19.05		124	30	82.20		111	66	37	19.0	SODI-SA93
	65...20	63.50		19.05		124		88.50		123	75	40	22.0	SODJ-SA93
	80...20	76.20		19.05		124		94.90		136	85	44	26.0	SODK-SA93
	100...20	101.60	2.11	19.05		124		107.10		161	108	54	36.0	SODL-SA93

DTS 1000516529 EN Version: N Status: RL (released | freigegeben | valide) printed: 28.04.2026

Diaphragm size	Port 1 – Port 2 DN	Ø D1	s1	Ø D2	s2	A	B	C	E	F	G	H	I	Product key ¹⁾ (Port 1 – Port 2)	
25	25...25	25.40	1.65	25.40	1.65	124.5	25	74.8	25	95	42	26	6.0	SODF-SODF	
	40...25	38.10		25.40		124.5		30		81.1	103	58	36	16.0	SODH-SODF
	50...25	50.80		25.40		134.5				87.5	120	75	44	24.0	SODI-SODF
	65...25	63.50		25.40		134.5				93.8	129	82	47	27.0	SODJ-SODF
	80...25	76.20		25.40		134.5				100.15	142	94	52	32.0	SODK-SODF
40	40...40	38.10	1.65	38.10	1.65	152.0	25	99.60	25	121	58	35	6.4	SODH-SODH	
	50...40	50.80		38.10		162.0		30		101.6	131	72	43	14.4	SODI-SODH
	65...40	63.50		38.10		162.0				107.90	143	85	50	21.4	SODJ-SODH
	80...40	76.20		38.10		162.0				114.3	156	98	56	27.4	SODK-SODH
50	50...50	50.80	1.65	50.80	1.65	188.0	30	115.8	30	145	71	42	6.5	SODI-SODI	
	65...50	63.50		50.80		188.0		122.10		157	85	50	14.5	SODJ-SODI	
	65...65	63.50		63.50		188.0		122.10		158	86	50	14.5	SODJ-SODJ	
	80...50	76.20		50.80		188.0		128.5		169	98	56	20.5	SODK-SODI	
	100...65	101.60		2.11		63.50		188.0		140.7	195	120	66	30.5	SODL-SODJ
65	65...65	63.50	1.65	63.50	1.65	210.0	30	136.6	30	172	84	49	6.5	SODJ-SODJ	
	80...65	76.2		63.50		210.0		145.0		187	99	57	14.5	SODK-SODJ	
	100...65	101.6		2.11		63.50		210.0		155.2	210	120	66	23.5	SODL-SODJ
80	80...80	76.2	1.65	76.2	1.65	255.0	30	157.35	30	199	106	64	6.0	SODK-SODK	
	100...80	101.6		2.11		76.2		255.0		169.6	224	131	77	26.0	SODL-SODK
100	100	101.6	2.11	101.6	2.11	290.0	30	207.0	30	260	120	67	10.0	SODL-SODL	
SMS 3008															
25	25...25	25.0	1.2	25.0	1.2	124.5	25	75.0	25	95	43	27	7.0	SA60-SA60	
	40...25	38.0		25.0		124.5		30		81.5	103	58	36	16.0	SA62-SA60
	50...25	51.0		25.0		134.5				88.0	118	72	42	22.0	SA63-SA60
40	40...40	38.0	1.2	38.0	1.2	152.0	25	95.6	25	121	58	35	6.4	SA62-SA62	
	50...40	51.0		38.0		162.0		30		102.1	131	73	44	15.4	SA63-SA62
50	50...50	51.0	1.2	51.0	1.2	188.0	30	120.2	30	154	82	48	2.5	SA63-SA63	
DIN 11850 - 0															
8	04...04	6.0	1.0	6.0	1.0	78.0	20	44.0	20	60	15	6.5	0.0	SC40-SC40	
	06...06	8.0		8.0		75.0	17.5	46.5		60	13	7	0.0	SC41-SC41	
	40...04	40.0		1.5		6.0	88.0	25		60.5	83	51	29	19.0	SC47-SC40
	40...8	40.0				10.0	88.0	60.5		83	51	29	19.0	SC47-SC42	
	50...04	52.0				6.0	98.0	30		66.5	95	60	32	22.0	SC48-SC40
15	50...15	52.0	1.5	18.0	1.5	113.0	30	72.4	20	101	65	36	22.5	SC48-SC43	
25	25...25	28.0	1.5	28.0	1.5	124.5	25	76.2	25	95	46	29	9.0	SC45-SC45	
	50...25	52.0		28.0		134.5		30		91.2	120	71	42	22.0	SC48-SC45
40	25...32	28.0	1.5	34.0	1.5	152.0	25	90.3	25	122	58	32	3.4	SC45-SC46	
	50...32	52.0		34.0		162.0		30		102.3	132	75	45	16.4	SC48-SC46
50	50...50	52.0	1.5	52.0	1.5	188.0	30	116.5	30	147	73	43	7.5	SC48-SC48	
65	65...65	70.0	2.0	70.0	2.0	210.0	30	142.0	30	179	89	52	14.0	SD48-SD48	
	80...65	85.0		70.0		210.0		149.5		194	104	59.5	21.5	SD49-SD48	
	100...65	104.0		70.0		210.0		-		-	-	-	-	SD50-SD48	
80	80...80	85.0	2.0	85.0	2.0	255.0	30	45.0	30	208	112	67	22.0	SD49-SD49	
	100...80	104.0		85.0		250.0		172.1		227	132	77	32.0	SD50-SD49	
100	100	104.0	2.0	104.0	2.0	293.0	30	211.5	30	267	125	70	11.0	SD50-SD50	

1.) This information is part of the product key (see "8.3. Bürkert Product Enquiry Form" on page 25).

DTS 1000516529 EN Version: N Status: RL (released | freigegeben | valide) printed: 28.04.2026

4.3. T-body with clamp connection

Note:

- Dimensions in mm, unless otherwise stated
- The clamp dimensions must be added to the welded connection dimensions.

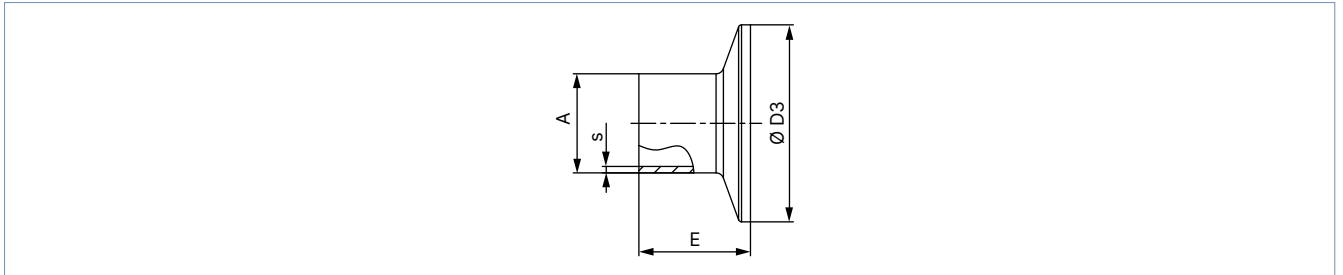

Port connection		A	s	D3	E	Product key ^{1.)}
[mm]	[inch]					
DIN 32676 series A (DIN pipe)						
10	–	13	1.5	34	18	TD41
15	–	19	1.5	34	18	TD42
20	–	23	1.5	34	18	TD43
25	–	29	1.5	50.5	21.5	TD44
32	–	35	1.5	50.5	21.5	TD45
40	–	41	1.5	50.5	21.5	TD46
50	–	53	1.5	64	21.5	TD47
65	–	70	2	91	28	TD48
80	–	85	2	106	28	TD49
100	–	104	2	119	28	TD50
DIN 32676 series B (ISO pipe)						
8	–	13.5	1.6	25	28.6	TC40
8	–	13.5	1.6	34 ^{2.)}	28.6	TC51 ^{2.)}
10	–	17.2	1.6	34 ^{2.)}	28.6	TC41 ^{2.)}
15	–	21.3	1.6	34 ^{2.)}	28.6	TC42 ^{2.)}
15	–	21.3	1.6	50.5	28.6	TC52
20	–	26.9	1.6	50.5	28.6	TC43
25	–	33.7	2	50.5	28.6	TC44
32	–	42.4	2	50.5 ^{2.)}	28.6	TC45 ^{2.)}
40	–	48.3	2	64	28.6	TC46
50	–	60.3	2	77.5	28.6	TC47
65	–	76.1	2	91	28.6	TC48
80	–	88.9	2.3	106	28.6	TC49
100	–	114.3	2.3	130	28.6	TC50
ASME BPE						
8	1/4"	6.35	0.89	25	28.6	TG50
10	3/8"	9.53	0.89	25	28.6	TG01
15	1/2"	12.7	1.65	25	28.6	TG02
20	3/4"	19.05	1.65	25	28.6	TG03
25	1"	25.4	1.65	50.5	28.6	TG04
40	1 1/2"	38.1	1.65	50.5	28.6	TG05
50	2"	50.8	1.65	64	28.6	TG06
65	2 1/2"	63.5	1.65	77.5	28.6	TG07
80	3"	76.2	1.65	91	28.6	TG08
100	4"	101.6	2.11	119	28.6	TG09

1.) This information is part of the product key (see "8.3. Bürkert Product Enquiry Form" on page 25).

2.) Deviating from standard because of different outside clamp diameter

5. Product connections

5.1. Electrical connection

Note:

For the terminal assignment of the connection variant "cable gland with connection terminals", see **operating instructions Type 3324** ▶.

Description of circular plug-in connectors

AG2 variant

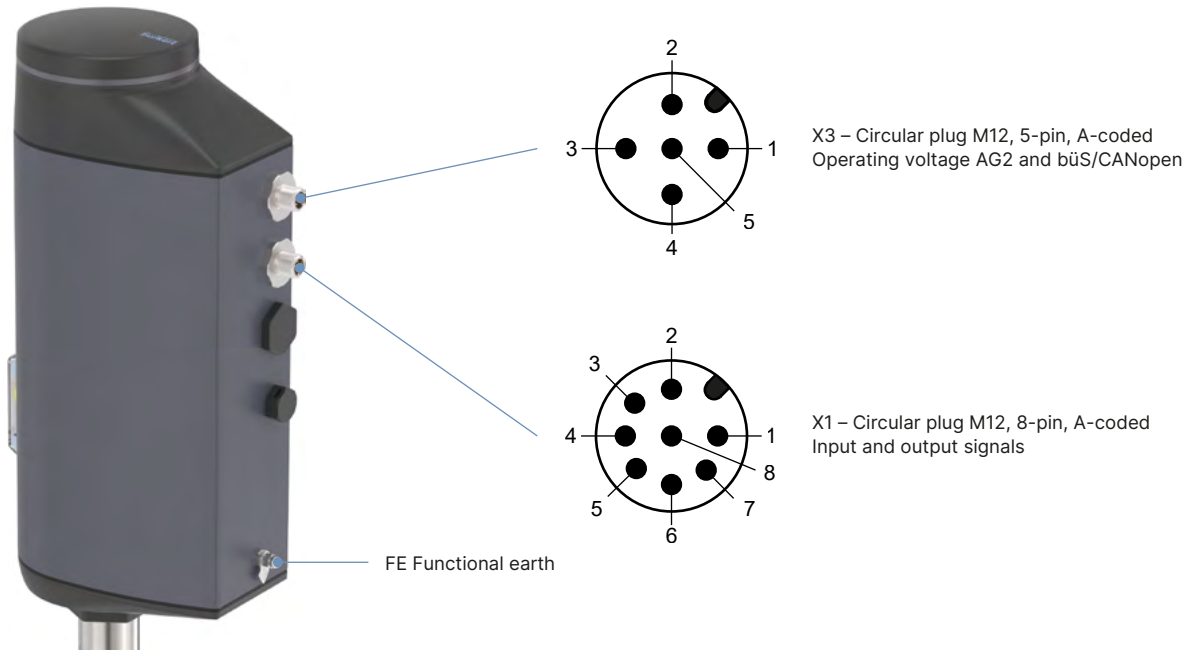

AG3 variant

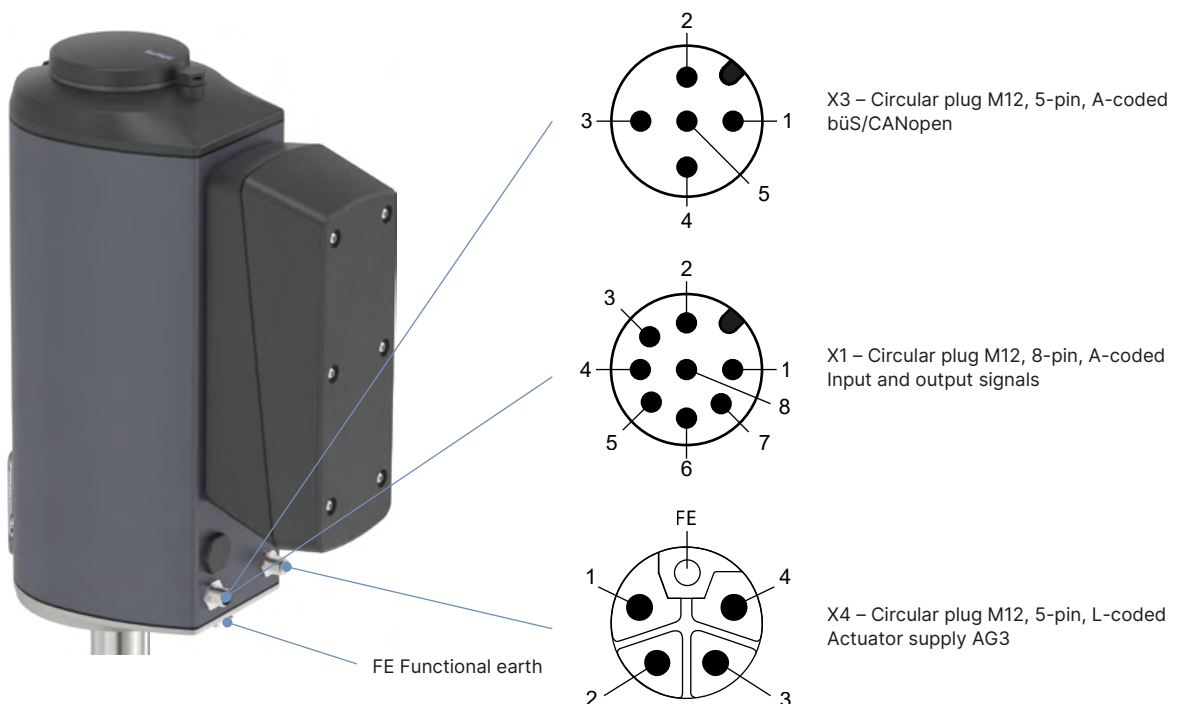

DTS 1000516529 EN Version: N Status: RL (released | freigegeben | valide) printed: 28.04.2026

Fieldbus gateway (optional)

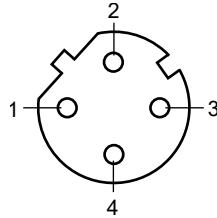

X7 – M12 round socket, 4-pin, D-coded, fieldbus connection (2-port Ethernet switch)

The following circular plug-in connectors are used depending on the device variant:

Circular plug-in connector	AG2			AG3		
	Electrical variant			Electrical variant		
	Binary with digital input (bÜS service interface)	With fieldbus gateway	bÜS/CANopen	Binary with digital input (bÜS service interface)	With fieldbus gateway	bÜS/CANopen
	0...5 V (log „0“) 10...30 V (log „1“)	for EtherNet/IP, PROFINET, Modbus TCP, EtherCAT protocols		0...5 V (log „0“) 10...30 V (log „1“)	for EtherNet/IP, PROFINET, Modbus TCP, EtherCAT protocols	
X1	X	–	–	X	–	–
X3	X	X	X	–	X	X
X4	–	–	–	X	X	X
X7	–	X	–	–	X	–

X = available
– = not available

Circular plug-in connector with pin assignment

Input and output signals

X1 – Circular plug M12, 8-pin, A-coded	Pin	Assignment
	1	Digital input +
	2	GND for digital input and digital outputs
	3	Digital output 2 +
	4	Digital output 1 +
	5	Do not connect
	6	Do not connect
	7	Do not connect
	8	Do not connect

Operating voltage AG2 and büS/CANopen

X3 – Circular plug M12, 5-pin, A-coded	Pin	Assignment
	1	CAN Shield / shield
	2	Operating voltage 24 V DC ± 10 %
	3	GND / CAN_GND
	4	CAN_H
	5	CAN_L

Operating voltage AG3

X4 – Circular plug M12, 5-pin, L-coded	Pin	Assignment
	1	Operating voltage 24 V DC ± 10 %
	2	Do not connect
	3	GND
	4	Do not connect
	FE	Functional earth, connected to housing

Fieldbus connection

X7 – Circular socket M12, 4-pin, D-coded	Pin	Assignment
	1	Transmit +
	2	Receive +
	3	Transmit -
	4	Receive -

DTS 1000516529 EN Version: N Status: RL (released | freigegeben | valide) printed: 28.04.2026

6. Performance specifications

6.1. Operating limits

Note:

For device variants with approvals or conformities, deviating technical operating limits (temperature, pressure) may apply. Refer to the corresponding approval-related documentation.

Medium pressure

Diaphragm size	Actuator size	Max. operating pressure for seal material		
		EPDM, FKM	PTFE/EPDM, advanced PTFE/EPDM (EU)	Laminate of GYLON® and EPDM (ER)
	[N]	[bar]	[bar]	[bar]
8	N (AG2 / 2500 N)	10	10	10
15		10	10	10
20		10	10	10
25		10	10	10
32		8	5.5	5.5
40	S (AG3 / 11500 N)	4	2.5	2.5
40		10	10	10
50		10	10	10
65		10	6	6
80		6	2.5	6
100		3.5	-	-

Operating limits for ambient and medium temperature

The maximum permissible temperature for the environment and the medium depend on each other. The maximum allowable temperature curves of different device variants are shown in the temperature chart.

Temperature diagram AG2

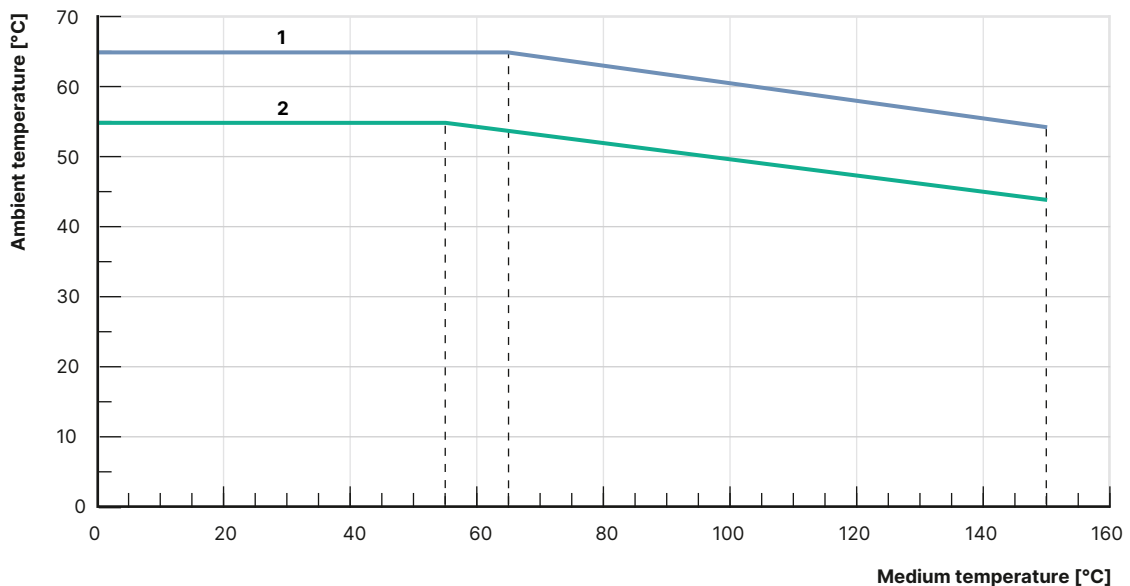

No.	Description
1	Devices without module
2	Devices with energy storage SAFEPOS energy-pack ¹⁾ or with fieldbus gateway

1.) The service life of the energy storage SAFEPOS energy-pack depends on the medium temperature and the ambient temperature.

DTS 1000516529 EN Version: N Status: RL (released | freigegeben | valide) printed: 28.04.2026

Temperature diagram AG3

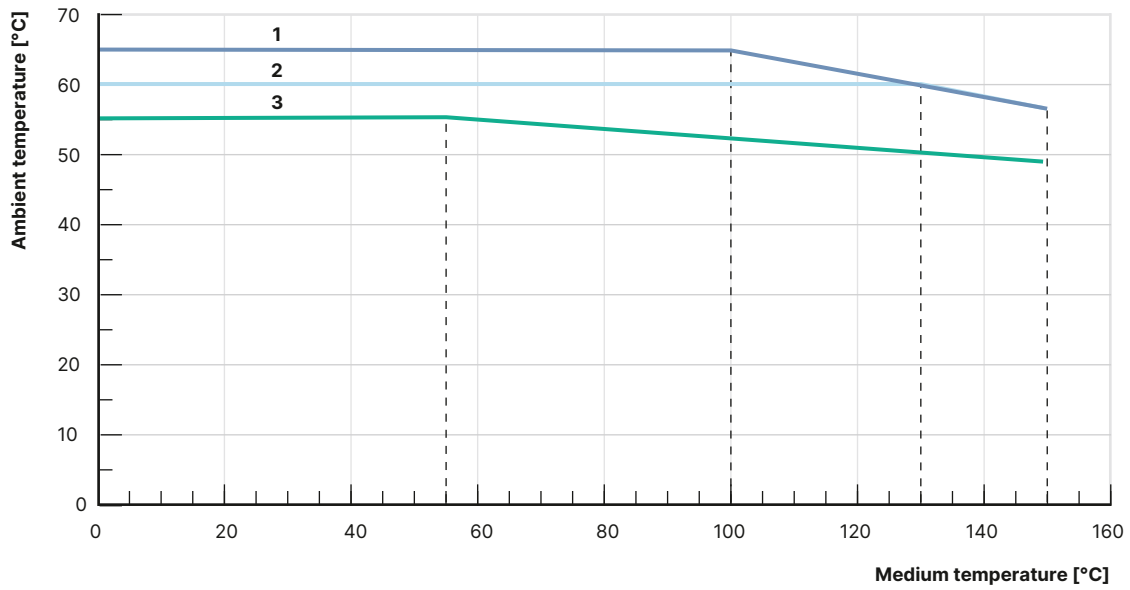

No.	Description
1	Devices without module
2	Devices with energy storage SAFEPOS energy-pack ¹⁾
3	Devices with fieldbus gateway

1.) The service life of the energy storage SAFEPOS energy-pack depends on the medium temperature and the ambient temperature.

6.2. Electrical control and interfaces

Interface diagram

The position of the actuator is regulated according to the position set-point value. The position set-point value is specified either by an external standard signal or via a fieldbus (digital).

Analogue control

For analogue control, 2 variants are available for each the inputs and outputs and the connection interface.

Inputs and outputs:

- 1 digital input, 2 digital outputs

Interface:

- Cable gland with connection terminals (only AG2)
- M12 circular plug-in connectors (optional)

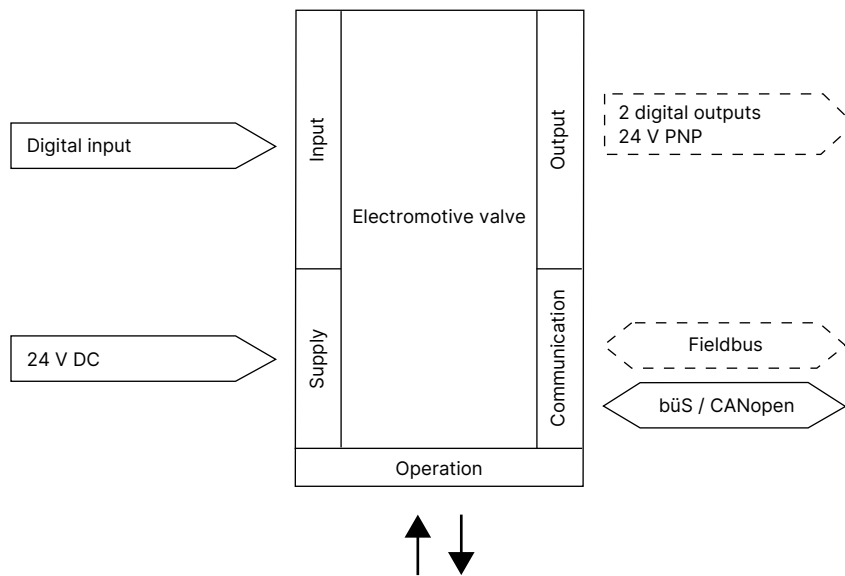

Note:
Optional outputs are represented as a broken line.

Control data	
Digital input	0...5 V = log „0“, 10...30 V = log „1“, inverted input inverted accordingly
Digital output (optional)	Current limitation 100 mA
Communication	
Communication interface (bùS)	Connection to PC via USB bùS interface set
Communication software (bùS)	Bürkert Communicator, see Type 8920 ▶

7. Product design and assembly

7.1. Product features

Note

Further information can be found in the **operating instructions Type 3324** ▶.

<p>User interface</p>	
<p>Device without display module The basic functions are operated by 4 DIP switches and 2 push buttons. These are located under the blind cover which can be removed manually by turning. Through the būs service interface, the device can also be configured in detail with the Bürkert Communicator software.</p> <p>For this, the optional USB-būs interface set is required (see "8.4. Ordering chart accessories" on page 26).</p>	<p>Blind cover dismantled</p> <p>1.) Non-functional in devices with display module. The display must be used for operation.</p>
<p>Actuation</p>	
<p>Mechanical manual override The manual override for mechanical movement of the valve is located for AG2 under the blind cover or display module and for AG3 under the pressure compensation element. It ensures that the actuator can be operated even if the power supply fails.</p>	<p>Mechanical manual override AG2</p>
<p>Electrical manual override The electrical manual override for the procedure is carried out via two buttons under the blind cover.</p>	
<p>Display elements</p>	
<p>Display 360° LED light ring A clearly visible 360° LED ring is attached to the blind cover or display module to indicate the device status, the valve end position and the operating state. The LED light ring lights up, blinks or flashes in one or changing colours, depending on the LED mode set.</p> <p>Mechanical position indicator: The mechanical position indicator shows the current valve position even if the supply voltage fails.</p>	<p>LED light ring as status indicator</p> <p>AG2 Mechanical position indicator (yellow)</p> <p>AG3 Mechanical position indicator (yellow)</p>

DTS 1000516529 EN Version: N Status: RL (released | freigegeben | valide) printed: 28.04.2026

Data transmission (optional)

SIM card (optional)

With the optionally available SIM card, device-specific values and user settings can be stored and quickly transferred to another device.

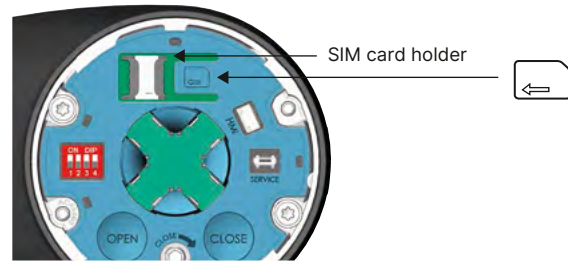

büS service interface

The büS service interface connects the device with the Bürkert Communicator software on a PC, laptop or smartphone. From there a configuration of the device or error diagnosis can be carried out.

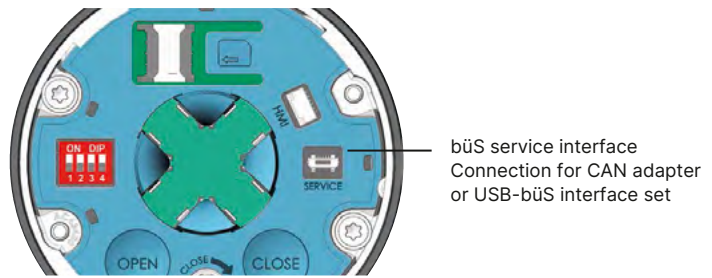

Safety position via energy storage (optional)

The safety starting positions in case of power interruption is realised with the optional energy storage SAFEPOS energy-pack. The desired position is set via the menu. In addition to the end positions (open/closed), any desired intermediate position can be defined here. The energy storage has a lifespan of up to 10 years, depending on the operating conditions. The power of the energy storage is monitored and a warning is displayed to indicate its service life is coming to an end. The storage device is designed as a plug-in module to facilitate replacement. Without energy storage, the valve remains in the last position it was in.

The energy storage device is fully charged and ready for operation after a maximum of 120 seconds (depending on the operating conditions).

The energy storage device cannot be retrofitted in the field.

AG2

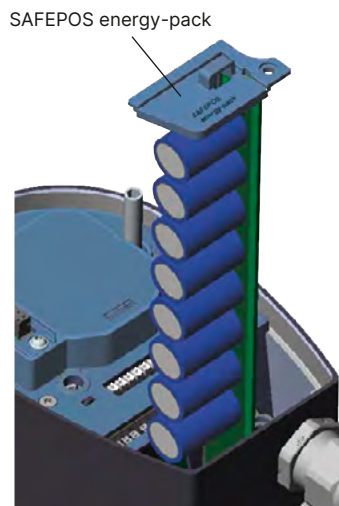

AG3



Fieldbus: EtherNet/IP, PROFINET, Modbus TCP, EtherCAT (optional)

The fieldbus gateway for EtherNet/IP, PROFINET, Modbus TCP and EtherCAT is integrated in an additional module. It has 2 fieldbus connections with 4-pin M12 circular sockets. The interfaces for the fieldbus connection and the status LEDs are located under the gateway housing cover. If there is a need for it to be included in a network, the Ethernet configuration can be performed via the web server.

The gateway cannot be retrofitted in the field.

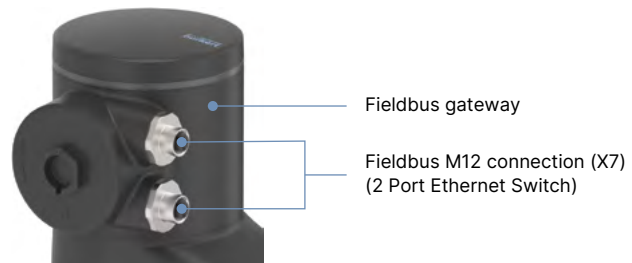

DTS 1000516529 EN Version: N Status: RL (released | freigegeben | valide) printed: 28.04.2026

7.2. Product assembly

The electromotive linear actuator consists of a brushless DC motor, a gear and a spindle system that transfers the force to the closing element. The integrated control electronics are controlled either by standard signals or via a fieldbus (digital). A positioner and a process controller are available as controller variants. The electromotive linear actuator is designed to provide optimum efficiency. At the same time, it keeps the valve tight and in position even at the maximum specified medium pressure in a powerless standstill. The optional energy storage device SAFEPOS energy-pack is available for the device. If the supply voltage fails, it supplies the actuator with the energy required to move the valve into the desired position which can be set in the menu.

The valve position can be changed manually in 2 ways. Either via the electrical manual control or via a mechanical manual control if no supply voltage is available. The device can be set and operated either via 2 capacitive keys and 4 DIP switches or optionally on a display with touch screen. Additionally, you can always operate the device via the bÜS service interface and using the Bürkert Communicator software.

The intelligent process valve Type 3324 offers the operator options for process monitoring, valve diagnosis and preventive maintenance. Internal measurements of the operating status are evaluated and, if necessary, issued as a warning or error message. These signal, for example, impermissible ambient and process conditions, functional deviations of components or the status of the energy storage device.

To increase diaphragm service life, the drive force is adapted to the diaphragm size. It can also be adapted to the operating conditions to achieve optimum service life.

Design of electromotive diaphragm valve Type 3324 AG2

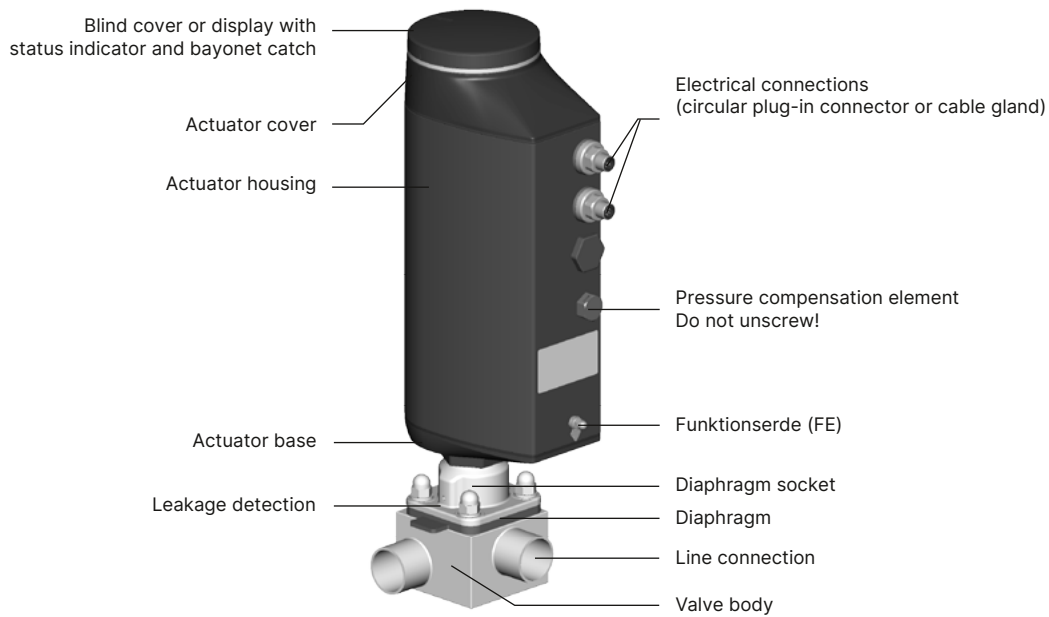

DTS 1000516529 EN Version: N Status: RL (released | freigegeben | valide) printed: 28.04.2026

Design of electromotive diaphragm valve Type 3324 AG3

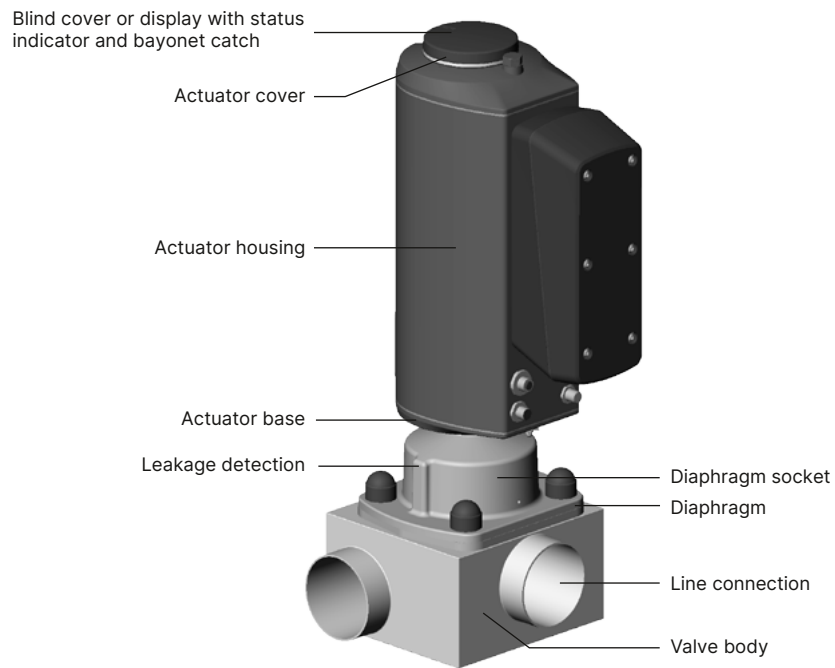

8. Ordering information

8.1. Bürkert eShop



Bürkert eShop – Easy ordering and quick delivery

You want to find your desired Bürkert product or spare part quickly and order directly? Our online shop is available for you 24/7. Sign up and enjoy all the benefits.

[Order online now](#)

8.2. Bürkert product filter



Bürkert product filter – Get quickly to the right product

You want to select products comfortably based on your technical requirements? Use the Bürkert product filter and find suitable articles for your application quickly and easily.

[Try out our product filter](#)

8.3. Bürkert Product Enquiry Form

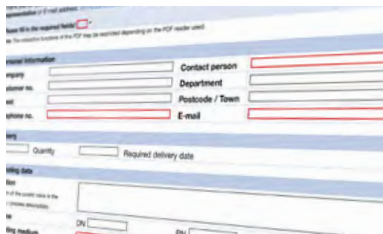

Bürkert Product Enquiry Form – Your enquiry quickly and compactly

Would you like to make a specific product enquiry based on your technical requirements? Use our Product Enquiry Form for this purpose. There you will find all the relevant information for your Bürkert contact. This will enable us to provide you with the best possible advice.

[Fill out the form now](#)





DTS 1000516529 EN Version: N Status: RL (released | freigegeben | valide) printed: 28.04.2026

8.4. Ordering chart accessories

Note:

For device variants with approvals or conformities, additional accessories may be required for intended use. Please refer to the relevant approval documentation.

Standard accessories





Description	Article no.
SIM card for data transmission between units	291773 
Holding device for port connection DN 08...DN 40 ¹⁾	697473 
Blind cover made of plastic	277881 
Wearing part energy storage SAFEPOS energy-pack (AG2)	285834 

1.) For diaphragm size 08, the holding device is included in the scope of delivery.

Accessories cable



Note:



For connection to a bÜS/CANopen network see „Supplement | Cabling guide bÜS/EDIP“ on our website under „User Manuals“, **Type 3324** .

Description	Article no.
M12 circular socket with cable, 4-pin, A-coded, cable length: 5 m, for X3, operating voltage AG2 (without communication)	918038 
M12 circular socket with cable, 8-pin, A-coded, cable length: 2 m, for X1, input and output signals	919061 
M12 circular plug with cable, 4-pin, D-coded to M12 straight plug, cable length: 5 m, for X7, fieldbus connection	775043 
M12 circular plug with cable, 4-pin, D-coded to RJ45 plug, cable length: 5 m, for X7, fieldbus connection	775053 

Bürkert accessories

Note:

- For connection to a bÜS/CANopen network see „Supplement | Cabling guide bÜS/EDIP“ on our website under „User Manuals“, **Type 3324** .
- For detailed accessory tables, see „Supplement | Cabling guide bÜS/EDIP“ on our website under „User Manuals“, **Type 3324** .

Description	Article no.
Bürkert Communicator software, Type 8920	Type 8920 
USB-bÜS interface set 1 (Type 8923)	772426 
USB-bÜS interface set 2 (Type 8923)	772551 
bÜS adapter for bÜS service interface (M12 on bÜS service interface micro USB), cable length: 0.3 mm	774931 