





Electromotive 2-way globe proportional valve

- Actuator is not wetted
- Excellent setting range and fast reaction time
- Low electrical power consumption
- Connection orifice DN 8...15
- Variants: standard, positioner, process controller and high-pressure variants for up to 22 bar



Product variants described in the data sheet may differ from the product presentation and description.

Can be combined with

	Type ME61 EDIP process display	▶
	Type ME43 Fieldbus gateway	▶
	Type 8098 FLOWave SAW flowmeter	▶
	Type 8008 Flowmeter for gases	▶
	Type 8325 Pressure transmitter for general applications, 0...25 bar	▶

Type description

The direct-acting Type 3280 motor valve is suitable for dosing liquids and gases in closed or open control loops. The valve is driven by a linear stepper motor. The integrated electronics assembly simplifies the process integration; additional actuation modules are not necessary. The engine does not need any energy to maintain a certain valve opening. This feature can reduce the energy consumption of a plant dramatically and therefore make it more efficient. Type 3280 is available as an on/off valve or proportional valve by default, as a variant with integrated positioner, and as a variant with integrated process controller.

Table of contents

1. General technical data	3
1.1. General	3
1.2. Electrical control and interfaces.....	4
2. Approvals and conformities	5
2.1. General notes	5
2.2. Conformity	5
2.3. Standards.....	5
2.4. North America (USA/Canada)	5
2.5. Foods and beverages/Hygiene.....	5
2.6. Others	5
Oxygen	5
3. Materials	6
3.1. Bürkert resistApp	6
3.2. Material specifications	6
4. Dimensions	7
4.1. Threaded variant.....	7
4.2. Sub-base variant	8
4.3. Cartridge variant	9
4.4. Capacitive buffer module	10
5. Product connections	11
5.1. Electrical connection	11
Pin assignment analogue	11
Pin assignment digital (fieldbus)	11
6. Performance specifications	12
6.1. Duty cycle derating diagram.....	12
6.2. Pressure range	13
Standard variant.....	13
High-pressure variant	13
6.3. Flow characteristic	14
Determination of the K_v value.....	14
Exemplary characteristic curve of the motor valve.....	14
7. Product operation	15
8. Product accessories	16
8.1. Accessories capacitive buffer module.....	16
8.2. Bürkert Communicator Software.....	16
8.3. Connection Type 3280 with Bürkert Communicator software	17
9. Ordering information	18
9.1. Bürkert eShop	18
9.2. Recommendation regarding product selection.....	18
9.3. Bürkert product filter.....	18
9.4. Bürkert Product Enquiry Form	18
9.5. Ordering chart accessories.....	19
Standard accessories	19
Accessories cable.....	19
Bürkert accessories.....	19

DTS 1000240084 EN Version: AK Status: RL (released | freigegeben | valide) printed: 24.03.2026

1. General technical data

1.1. General

Product properties	
Dimensions	Further information can be found in chapter “4. Dimensions” on page 7.
Material	
Further information can be found in chapter “3.2. Material specifications” on page 6.	
Seal ¹⁾	<ul style="list-style-type: none"> • NBR for liquids • EPDM for liquids and special gases (e. g. ammonia, acetylene) • FKM for neutral gases
Valve body	Brass, stainless steel
Orifice	DN 8...DN 15, NPS ¼, ⅜, ½
Flow direction	Against closing direction (below seat)
Design	<ul style="list-style-type: none"> • Globe on/off valve • Globe control valve
Weight	~0.7 kg
Controller variant	Standard on/off, standard control valve, position controller or process controller
Safety setting in case of power failure	With capacitive buffer module as accessory, see chapter “4.4. Capacitive buffer module” on page 10.
Status display	LED (Refer to the operating instructions Type 3280 ▶ for more information.)
Performance data	
Typical values of positioning behaviour²⁾	
Dead band of the position control	± 0.5 % (corresponds to setting range 1:100)
Closing time	2.5 s
Operating pressure	<ul style="list-style-type: none"> • 0...6 bar(g) • High pressure variant up to 22 bar(g) optionally available (depending on seat size, see chapter “6.2. Pressure range” on page 13) • Vacuum variant up to -0.9 bar(g) optionally available
Duty cycle	Up to 100 % (depending on medium and ambient temperature)
K _{vs} value	0.03...1.9 m ³ /h (see chapter “6.2. Pressure range” on page 13)
Electrical data	
Operating voltage	24 V DC ± 10 % (max. residual ripple 10 %)
Power consumption	< 1 W in holding position Max. 8 W (DN 2...DN 6) resp. max. 12 W (DN 8 and DN 10, as well as high-pressure variants)
Medium data	
Operating medium	Neutral gases and liquids
Medium temperature	<ul style="list-style-type: none"> • EPDM (seal material): - 30 °C...+ 70 °C • FKM, NBR (seal material): 0 °C...+ 70 °C
Viscosity	Max. 600 mm ² /s (cSt)
Product connections	
Port connection ³⁾	<ul style="list-style-type: none"> • Threaded connection <ul style="list-style-type: none"> – G (EN ISO 228 - 1) – NPT (ASME B 1.20.1) • Flange connection • Cartridge connection Further information can be found in chapter “4. Dimensions” on page 7.
Communication and control	
Standard signal (analogue)	Set-point value: binary, 0/4...20 mA, 0...5/10 V and digital input, see chapter “1.2. Electrical control and interfaces” on page 4.
Fieldbus (digital)	<ul style="list-style-type: none"> • Bürkert system bus (büS) • CANopen (optional)
EDIP	Field device for integration into the EDIP platform via Bürkert system bus (büS) Further information can be found in chapter “8.2. Bürkert Communicator Software” on page 16.

Approvals and conformities	
Degree of protection	IP54
North America (USA/Canada)	Further information can be found in chapter "2.4. North America (USA/Canada)" on page 5.
Foods and beverages/Hygiene	Further information can be found in chapter "2.5. Foods and beverages/Hygiene" on page 5.
Others	Further information can be found in chapter "2.6. Others" on page 5.
Environment and installation	
Installation position	As required, preferably with actuator upright
Ambient temperature ^{4.)}	- 10 °C...+ 60 °C (Derating see chapter "6.1. Duty cycle derating diagram" on page 12)

- 1.) For seat sizes 1 and 1.5, PEEK seat seals are used. In this case the seat tightness of the valve is reduced.
- 2.) The characteristic values of the control behaviour depend on the operating conditions and refer to the final value.
- 3.) Others on request
- 4.) Maximum ambient temperature for high-pressure variant and from seat size 8 and 10 mm + 50 °C

1.2. Electrical control and interfaces

Technical data	Device variant					
	Standard (G/H)		Positioner (C)		Process controller (D)	
	On/off (G)	Control valve (H) ^{1.)}	Analogue	Digital (fieldbus)	Analogue	Digital (fieldbus)
Electrical connection	M12 plug, A-coded, 8-pin	M12 plug, A-coded, 8-pin	M12 plug, A-coded, 8-pin	M12 plug, A-coded, 5-pin	M12 plug, A-coded, 8-pin and M12 socket, A-coded, 5-pin	M12 plug, A-coded, 5-pin and M12 socket, A-coded, 5-pin
Input signal (set-point value)	Digital input: 0...5 V (log. 0, valve closed) or 10...30 V (log. 1, valve open)	4...20 mA, 0...10 V or PWM (800 Hz, 24 V, min: 10 V, max: 30 V)	4...20 mA, 0...20 mA, 0...10 V or 0...5 V PWM (800 Hz, 24 V, min: 10 V, max: 30 V)	–	4...20 mA, 0...20 mA, 0...10 V or 0...5 V PWM (800 Hz, 24 V, min: 10 V, max: 30 V)	–
Input signal (actual value from ext. Sensor)	–	–	–	–	4...20 mA, 0...20 mA, 0...10 V or 0...5 V	4...20 mA, 0...20 mA, 0...10 V, 0...5 V or frequency (5...2000 Hz)
Input impedance for analogue input	22 kΩ	60 Ω (current), 22 kΩ (voltage)	60 Ω (current), 22 kΩ (voltage)	–	60 Ω (current), 22 kΩ (voltage)	60 Ω (current), 22 kΩ (voltage)
Output signal (actual value)	Digital output: PNP, max. 100 mA current limits, feedback function (output signal active, when valve closed)	Digital output: PNP, max. 100 mA current limits, feedback function (output signal active, when valve closed)	0/4...20 mA (max. load: 560 Ω), 0...5/10 V (max. current: 10 mA)	–	0/4...20 mA (max. load: 560 Ω), 0...5/10 V (max. current: 10 mA)	–
Fieldbus interface	–	–	–	büS/CANopen	–	büS/CANopen
Parameterisation Tool	–	–	Bürkert Communicator (Connection via büS stick)	Bürkert Communicator (Connection via büS stick)	Bürkert Communicator (Connection via büS stick)	Bürkert Communicator (Connection via büS stick)

1.) The standard control valve variant is a proportional valve which, like the positioner variant, changes the valve stroke continuously depending on the input signal. This variant has no büS interface and no analogue output signal.

DTS 1000240084 EN Version: AK Status: RL (released | freigegeben | valide) printed: 24.03.2026

2. Approvals and conformities

2.1. General notes

- The approvals and conformities listed below must be stated when making enquiries. This is the only way to ensure that the product complies with all required specifications.
- Not all available variants can be supplied with the below mentioned approvals or conformities.

2.2. Conformity

In accordance with the Declaration of conformity, the product is compliant with the EU Directives.

2.3. Standards

The applied standards which are used to demonstrate compliance with the EU Directives are listed in the EU-Type Examination Certificate and/or the EU Declaration of Conformity.

2.4. North America (USA/Canada)

Approval	Description
	<p>Optional: UL Recognized for the USA and Canada ¹⁾ The products are UL Recognized for the USA and Canada according to:</p> <ul style="list-style-type: none"> • UL 429 (electrically operated valves) • CAN/CSA-C22.2 No. 139 (electrically operated valves)

1.) This device is intended to be used with a NEC Class 2 power source or NEC Class 2 transformer in accordance with UL1310 or UL1585.

2.5. Foods and beverages/Hygiene

Conformity	Description
FDA	<p>FDA – Code of Federal Regulations All wetted materials are compliant with the Code of Federal Regulations published by the FDA (Food and Drug Administration, USA) according to the manufacturer's declaration.</p>

2.6. Others

Oxygen

Conformity	Description
	<p>Oxygen In their composition, the products are suitable for use with gaseous oxygen (optional).</p>

DTS 1000240084 EN Version: AK Status: RL (released | freigegeben | valide) printed: 24.03.2026

3. Materials

3.1. Bürkert resistApp

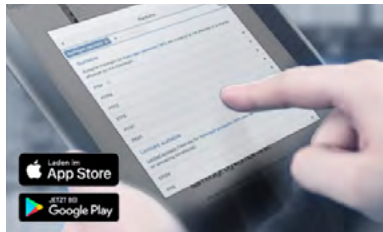

Bürkert resistApp – Chemical resistance chart

You want to ensure the reliability and durability of the materials in your individual application case? Verify your combination of media and materials on our website or in our resistApp.

[Start chemical resistance check](#)

3.2. Material specifications

Note:

The globe control valve Type 3280 is supplied with various port connections. These connections are not shown completely. However, they correspond to the material of the valve housing.

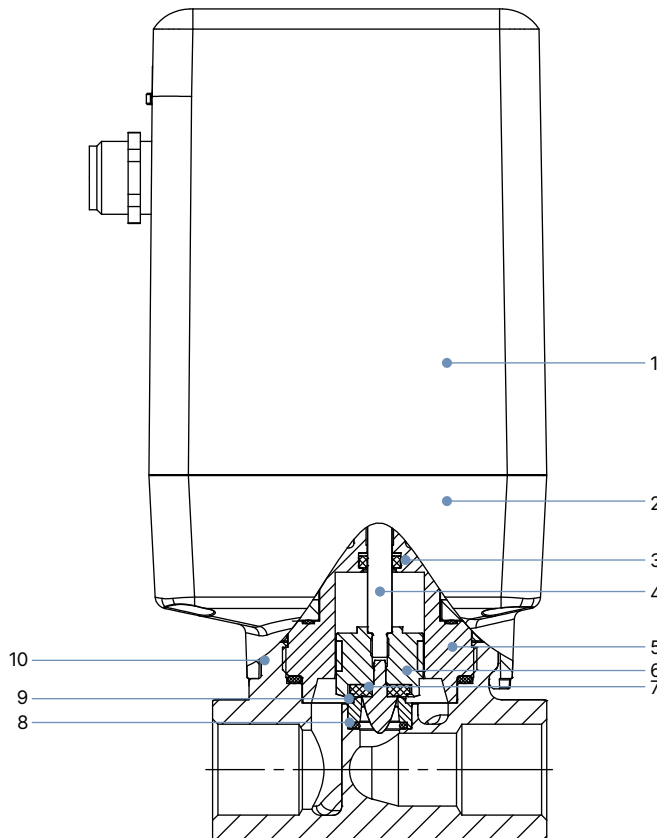

Actuator

No.	Element	Material
1	Housing cover	PC (Polycarbonate)
2	Housing base	PPS (Polyphenylenesulfide)

Valve body

No.	Element	Material
3	Spindle seal	FKM/EPDM/NBR
4	Spindel	Stainless steel 1.4305
5	Upper valve body	Brass or stainless steel 1.4305
6	Piston with parabolic control element and guiding shaft	PTFE Stainless steel 1.4305
7	Elastomer seat seal	FKM/EPDM/NBR
8	O-ring	FKM/EPDM/NBR
9	Seat	Stainless steel 1.4301/1.4305
10	Valve body	Brass or stainless steel AISI 316L

DTS 1000240084 EN Version: AK Status: RL (released | freigegeben | valide) printed: 24.03.2026

4. Dimensions

4.1. Threaded variant

Note:

Dimensions in mm

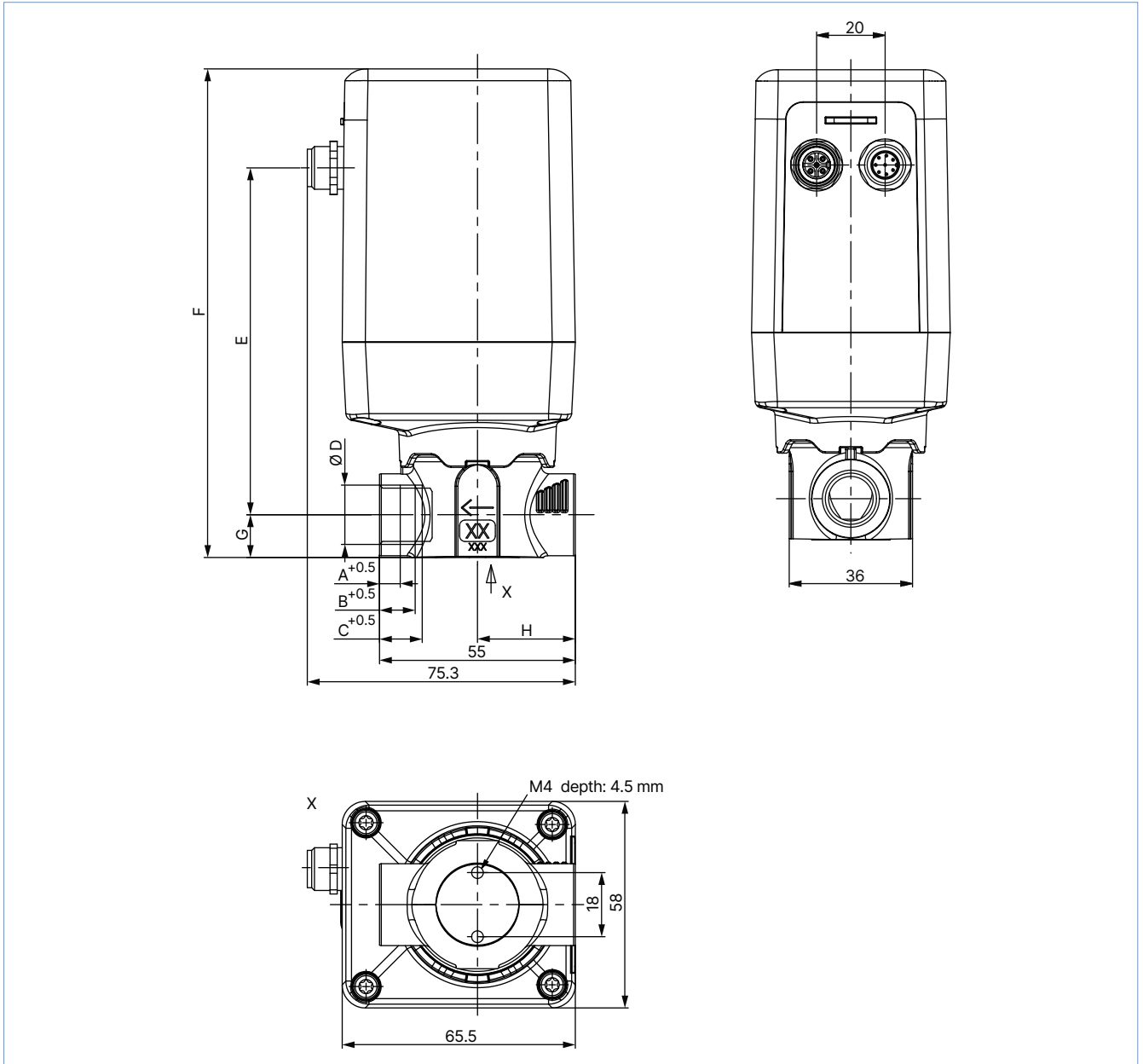

A	B	C	D	E	F	G	H
-	-	12	G 3/8	97.4	137.2	12	27.5
6	10.3	-	NPT 3/8	97.4	137.2	12	27.5
-	-	12	G 1/4	96.4	134.2	10	27.5
5.8	10	-	NPT 1/4	96.4	134.2	10	27.5
-	-	14	G 1/2	97.4	139.2	14	29.5
8.2	13.7	-	NPT 1/2	97.4	139.2	14	29.5

DTS 1000240084 EN Version: AK Status: RL (released | freigegeben | valide) printed: 24.03.2026

4.2. Sub-base variant

Note:

Dimensions in mm

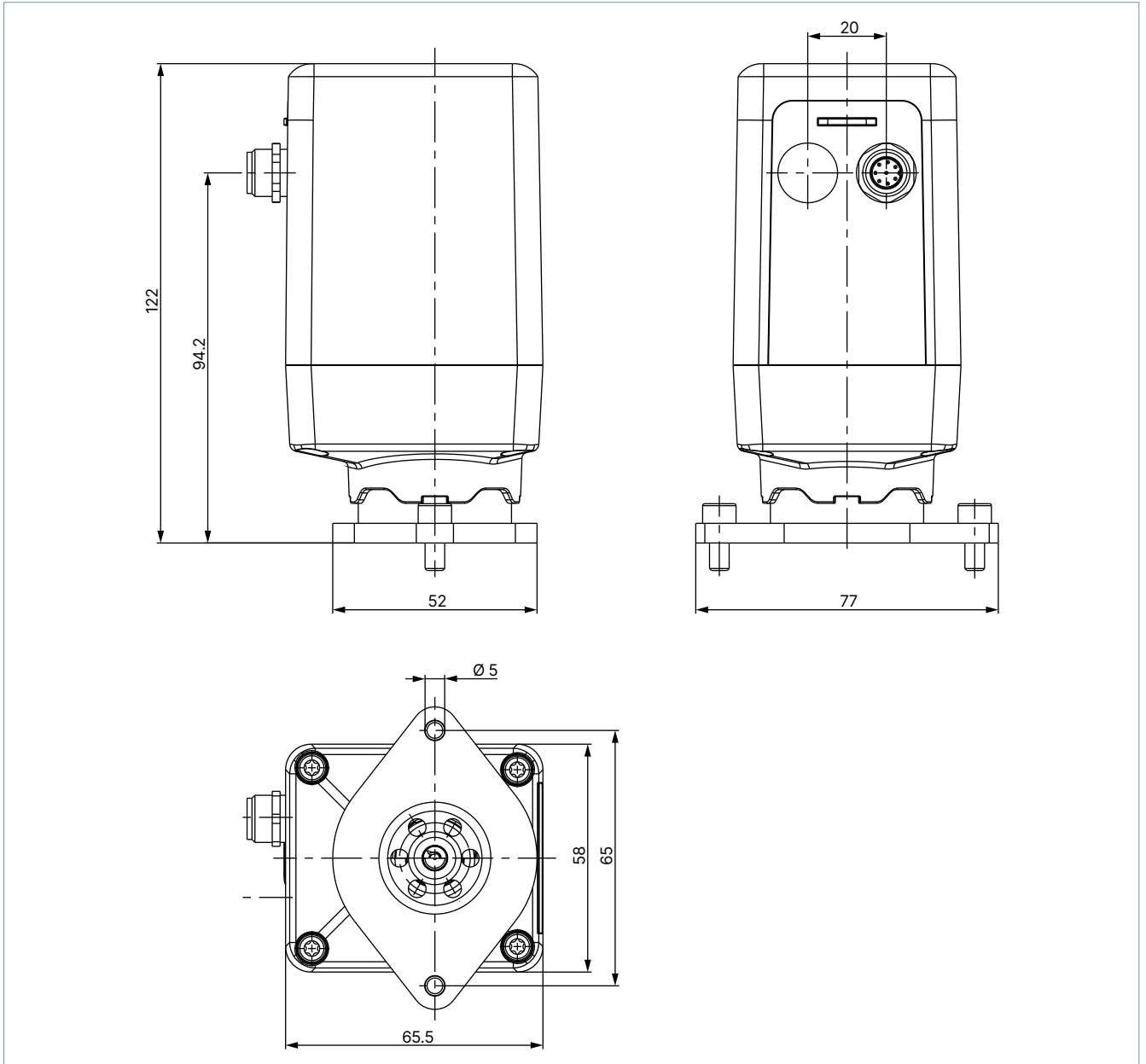

DTS 1000240084 EN Version: AK Status: RL (released | freigegeben | valide) printed: 24.03.2026

4.3. Cartridge variant

Note:

- Dimensions in mm
- Installation drawing for cartridge body see **operating instructions Type 3280** ▶

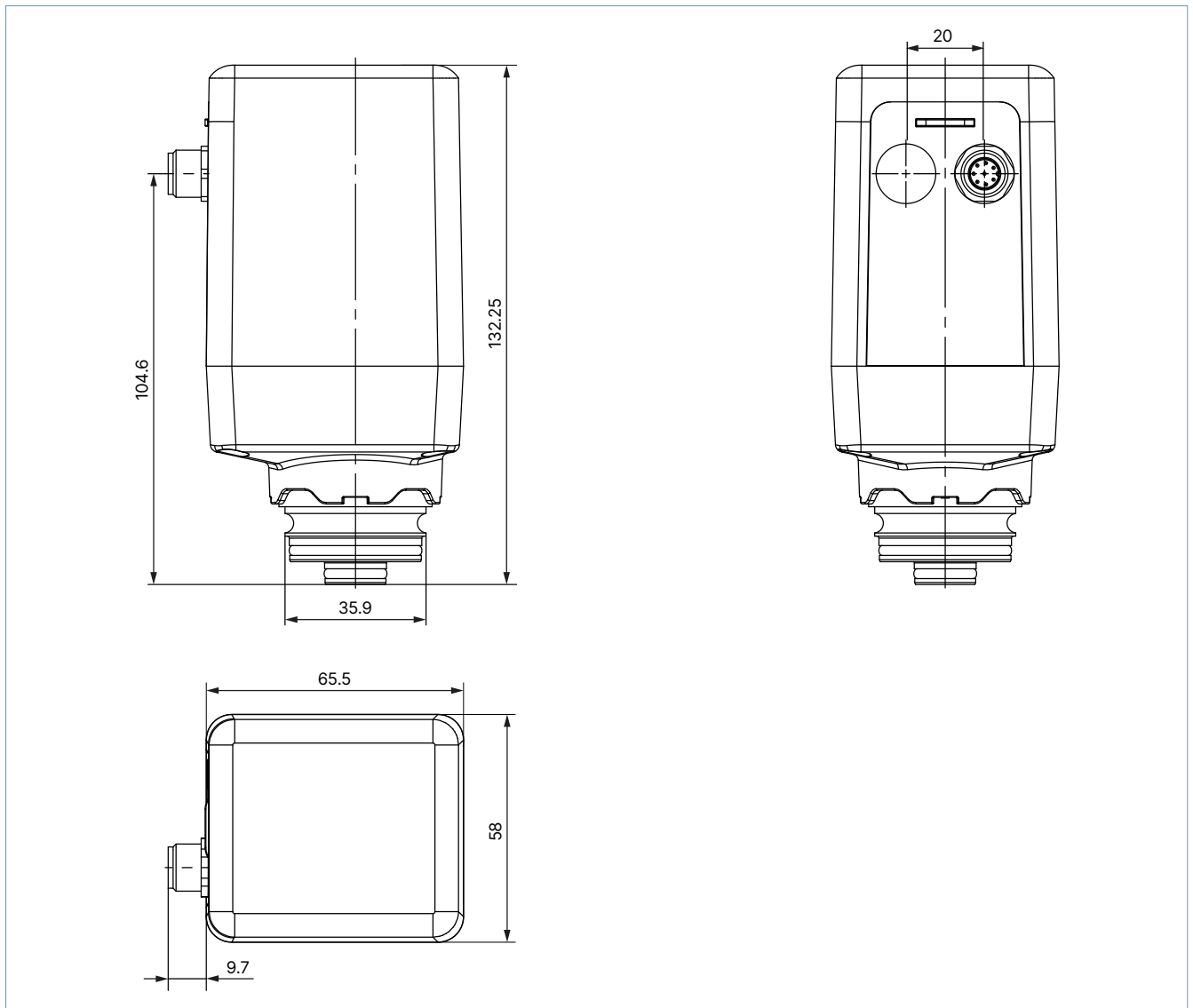

4.4. Capacitive buffer module

Note:

- Dimensions in mm
- Further information can be found in chapter "8.1. Accessories capacitive buffer module" on page 16.

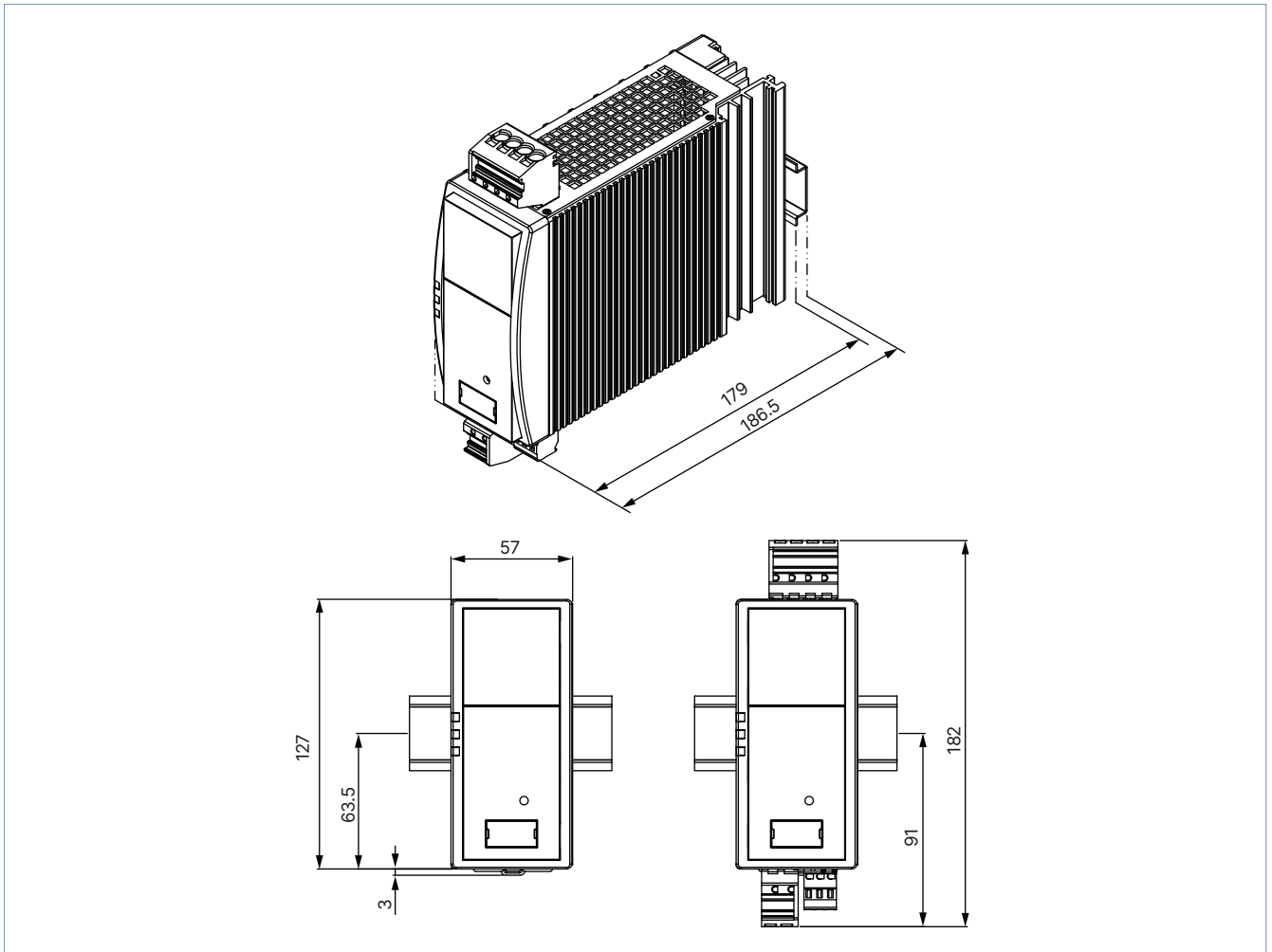

5. Product connections

5.1. Electrical connection

Pin assignment analogue

Note:

For parameterisation and configuration of the positioner and the process controller variants, please use the Bürkert Communicator software tool, see ["8.2. Bürkert Communicator Software" on page 16](#).

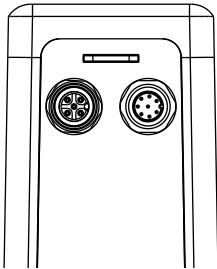

Circular plug M12, 8-pin	Pin	Configuration
	1	24 V DC
	2	Power supply GND
	3	Internal use ¹⁾
	4	Internal use ¹⁾
	5	Internal use ¹⁾
	6	Signal input +
	7	Signal output
	8	Signal GND

1.) Only for positioners and process controllers variant, for connection of the parameterisation tools: Bürkert Communicator. The connection is via the bÜS-Stick. Using an adapter cable (M12 8-pin to M12 5-pin) the bÜS-Stick can be connected (see ["9.5. Ordering chart accessories" on page 19](#)).

Additional for process controller variant:

Socket M12, 5-pin	Pin	Configuration
	1	24 V DC sensor power supply
	2	Analogue I_N (0...20 mA, 4...20 mA, 0...5 V or 0...10 V)
	3	GND
	4	GND (bridge to GND pin 3)
	5	Not connected

Pin assignment digital (fieldbus)

Note:

For parameterisation and configuration of the positioner and the process controller variants, please use the Bürkert Communicator software tool, see ["8.2. Bürkert Communicator Software" on page 16](#).

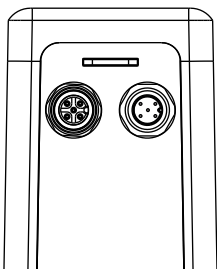

Circular plug M12, 5-pin	Pin	Configuration
	1	Shield
	2	24 V DC
	3	GND
	4	CAN_H
	5	CAN_L

Additional for process controller variant:

Socket M12, 5-pin	Pin	Configuration
	1	24 V DC sensor power supply
	2	Analogue I_N (0...20 mA, 4...20 mA, 0...5 V, 0...10 V or frequency)
	3	GND
	4	GND (bridge to GND pin 3)
	5	Not connected

6. Performance specifications

6.1. Duty cycle derating diagram

Note:

- The duty cycle is an important factor for motor valves. The self-heating of the engine limits the maximum duty cycle. High ambient temperatures additionally increase the risk of damage due to overheating. The following diagram shows the recommended maximum duty cycle as a function of the ambient temperature. In energy-saving mode (lower driving force), higher duty cycles are possible. The motor is optimised for the valve function in terms of size, power consumption and costs.
- The duty cycle does not mean the duty cycle of the device but the duty cycle of the motor. This is only switched on when the valve is to move. Frequent set-point value changes drastically increase the duty cycle of the motor.
- Operating the valve outside the recommended duty cycle limits will result in a significantly reduced service life of the valve.

Type 3280

Seat DN1...6 < 6 bar standard

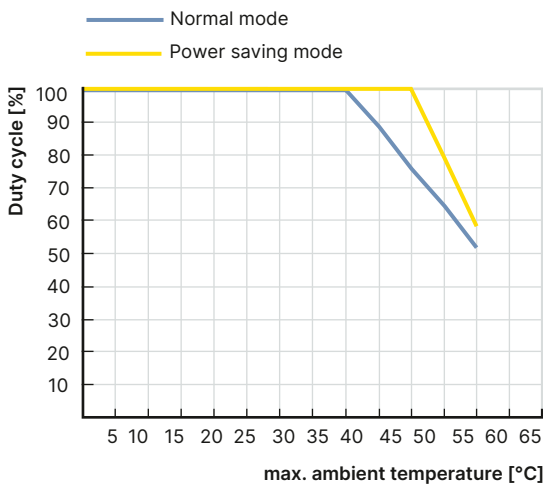

Type 3280

Seat DN1...6 < 6 bar positioner and process controller
 DN8...10 < 6 bar standard
 DN1...10 > 6 bar standard

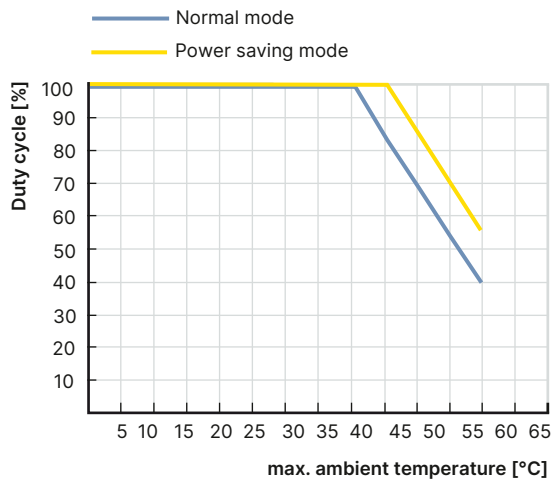

Derating curve for positioner and process controller DN 8...DN 10: see **operating instructions Type 3280** ▶.

DTS 1000240084 EN Version: AK Status: RL (released | freigegeben | valide) printed: 24.03.2026

6.2. Pressure range

Standard variant

Note:

For orders from our standard product range, use the product filter in our eShop (see ["9.1. Bürkert eShop" on page 18](#)). Alternatively, you can use the Product Enquiry Form (see ["9.4. Bürkert Product Enquiry Form" on page 18](#)) for information about the device layout and send it to us after completion.

Valve function	Seat size	Port connection	K _{vs} -value	Pressure range
			[m ³ /h] ¹⁾	[bar(g)]
Control valve, without safety position in case of power failure	1	G ¼	0.030	0...6
	1.5	G ¼	0.065	0...6
	2	G ¼	0.130	0...6
	3	G ¼	0.300	0...6
	4	G ⅜	0.500	0...6
	5	G ⅜	0.750	0...6
	6	G ⅜	0.900	0...6
	8	G ½	1.500	0...6
	10	G ½	1.900	0...6

1.) Flow value for water, measurement at + 20 °C, 1 bar pressure difference above the fully open valve

High-pressure variant

Note:





- For orders from our standard product range, use the product filter in our eShop (see ["9.1. Bürkert eShop" on page 18](#)). Alternatively, you can use the Product Enquiry Form (see ["9.4. Bürkert Product Enquiry Form" on page 18](#)) for information about the device layout and send it to us after completion.
- For applications requiring a higher operating pressure, high-pressure variants are available. Please note that for the high-pressure variant, the control in the lower range of the characteristic curve (< 5 % of the max. set point) can be impaired.

Valve function	Seat size	Port connection	K _{vs} -value	Pressure range fluid media	Pressure range gaseous media
			[m ³ /h] ¹⁾	[bar(g)]	[bar(g)]
Control valve, without safety position in case of power failure	1	G ¼	0.030	0...15	0...22
	1.5	G ¼	0.065	0...15	0...22
	2	G ⅜	0.130	0...15	0...22
	3	G ⅜	0.300	0...15	0...22
	4	G ⅜	0.500	0...12 ²⁾	0...12 ²⁾
	5	G ⅜	0.750	0...12 ²⁾	0...12 ²⁾
	6	G ⅜	0.900	0...15	0...16
	8	G ½	1.500	0...12	0...12
	10	G ½	1.900	0...10	0...10

1.) Flow value for water, measurement at + 20 °C, 1 bar pressure difference above the fully open valve

2.) Pressure range 0...12 bar for sealing material FKM, pressure range 0...15 bar for sealing material EPDM, NBR

Further variants on request

 Additional Variant with vent hole: Valve with vent hole to detect wear of the stem seal (optional).	 Voltage Variant with connections above the valve inlet: Valve with the electrical connections above the valve inlet (optional)
 Temperature Low temperature variant: Suitable for minimum medium temperatures down to - 30 °C (sealing material EPDM) (optional)	 Pressure Vacuum variant: This variant is suitable up to - 0.9 bar(g) (optional)

6.3. Flow characteristic

Determination of the K_v value

Note:

Once the K_v -value required for the application has been calculated, it can be compared with the K_{vs} -values from the ordering chart. The K_{vs} -value must be higher than the K_v -value of the application, but should be neither too high nor too close to it - as a recommendation: 10 % higher.

Pressure drop	K_v value for liquids [m ³ /h]	K_v value for gases [m ³ /h]
Sub-critical $p_2 > \frac{p_1}{2}$	$= Q \sqrt{\frac{\rho}{1000 \Delta p}}$	$= \frac{Q_N}{514} \sqrt{\frac{T_1 \rho_N}{p_2 \Delta p}}$
Supercritical $p_2 < \frac{p_1}{2}$	$= Q \sqrt{\frac{\rho}{1000 \Delta p}}$	$= \frac{Q_N}{257 p_1} \sqrt{T_1 \rho_N}$

Value	Description	Unit
K_v	Flow coefficient	[m ³ /h] ^{1.)}
Q_N	Standard flow rate	[m ³ /h] ^{2.)}
p_1	Inlet pressure	[bar] ^{3.)}
p_2	Outlet pressure	[bar] ^{3.)}
Δp	Differential pressure $p_1 \dots p_2$	[bar]
ρ	Density	[kg/m ³]
ρ_N	Standard density	[kg/m ³]
T_1	Medium temperature	[(273+t)K]

- 1.) Measured for water, $\Delta p = 1$ bar, over the value
- 2.) At reference conditions 1.013 bar and 0 °C (273 K)
- 3.) Absolute pressure

Exemplary characteristic curve of the motor valve

Note:

The dimensioning of the seat size is very important for electromotive proportional valves to function properly within the application. The seat size must be selected so that, on the one hand, the desired flow range is achieved and, on the other hand, when the valve is fully open, a sufficient portion of the total pressure drop occurs across the valve.

Reference value: $\Delta p_{\text{valve}} > 25\%$ of the total pressure drop

Otherwise, an ideal, linear valve characteristic is deformed into a curved system characteristic.

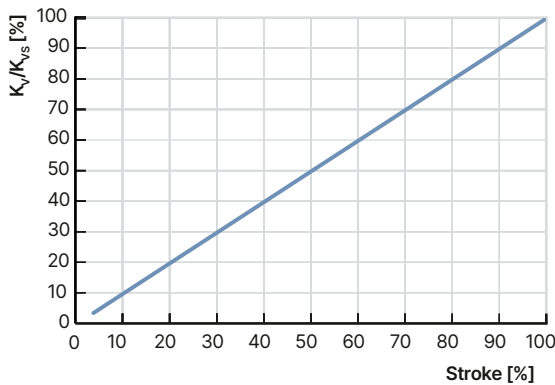

Linear flow characteristic - the K_{vs} values of the respective seat sizes can be found in chapter "6.2. Pressure range" on page 13.

DTS 1000240084 EN Version: AK Status: RL (released | freigegeben | valide) printed: 24.03.2026

7. Product operation

Standard on/off valve

In the on/off variant, an external voltage signal is digitized and the valve is closed or opened. The status of the two end positions of the valve are indicated on the LED. In addition, the valve position "closed" is reached via the digital output.

Standard control valve

The standard proportional valve converts an external standard signal (position set-point value) into a valve position. Both valve end positions are indicated by the LED status. Additionally, the digital output indicates when the "closed" valve position has been achieved.

Process diagram	Description
	<p>Positioner variant</p> <p>The proportional valve in the position control variant converts an external standard signal, the position set-point value, into a valve position. The position of the actuator is controlled according to the set-point position. The position sensor records the current position (POS) of the electromotive valve. This actual position is compared by the positioner with the set-point value (CMD) specified as the standard signal. If there is a control difference (Xd1), a motor control signal is given to the actuator as the actuating variable. Z1 is a disturbance value.</p> <p>The two end positions of the valve are indicated by the LED status. In addition, the actual position recorded by the position sensor is output via the M12 circular plug-in connector.</p>
	<p>Process controller variant</p> <p>The additionally implemented PID controller can perform not only the actual position control but also a process control in the sense of a cascade control.</p> <p>The process controller is integrated into a control loop. The position setpoint of the valve is calculated from the process setpoint and the actual process value via the control parameters (PID controller). The process setpoint can be specified by an external signal. During the process control the position control mentioned above becomes the subordinate auxiliary control circuit; this results in a cascade control. The process controller in the main control circuit has a PID function.</p> <p>The process set-point value (SP) is specified as a set-point value and is compared with the actual value (PV) of the process variable to be controlled. The position measuring system records the current position (POS) of the electromotive linear actuator. This position actual value is compared by the position controller with the set-point value (CMD) specified by the process controller. If there is a control difference (Xd2), the actual position (POS) and therefore the valve opening are changed by the control variable (CTRL). Z2 represents a disturbance variable.</p>

DTS 1000240084 EN Version: AK Status: RL (released | freigegeben | valide) printed: 24.03.2026

8. Product accessories

8.1. Accessories capacitive buffer module

Note:

- See [“4.4. Capacitive buffer module” on page 10](#) for information about dimensions.
- See [“Standard accessories” on page 19](#) for ordering information.

Accessories	Description
<p>Motor valve(s) connection</p>  <p>24 V DC power supply For example: Single phase, primary switched mode power supply Type 1573</p>	<ul style="list-style-type: none"> • Capacitive buffer module for moving to a safety position in case of power failure • In order to be able to move to a safety position of the valve in the event of a power failure, the valve must be supplied with voltage via the capacitive buffer module. In the event of a power failure, the buffer module provides an output voltage of 18 V DC for a few seconds. The reduced input voltage is detected by the valve and the safety position is approached accordingly. Up to 3 valves of Type 3280 or 2 valves of Type 3281 and Type 3285 can be connected to a buffer module. Factory setting of the safety position: “valve closed” • For standard variant (functionality available from software version A.08): Adjustable via DIP switch (when the effective direction is reversed, the safety position changes to “valve open”) • For positioner and process controller variant (functionality available from software version A.06): Adjustable via Bürkert Communicator (user-defined safety position)

8.2. Bürkert Communicator Software

Note:

- An adjustment of the valve by the Bürkert Communicator is only possible with the positioner or process controller variants.
- The associated communication software can be downloaded under **Type 8920** ▶.

The Bürkert Communicator is the most important software tool of the device platform EDIP (Efficient Device Integration Platform). The extensive features of this universal tool facilitate the configuration and parameterisation of all devices equipped with the digital CANopen-based interface.

The Bürkert Communicator provides the user with a complete overview of all cyclic process values and acyclic diagnostic data. The integrated graphical programming environment enables the creation of control functions for decentralised sub-systems. The connection to the PC can be established via a USB-büS interface set. This is available as an accessory (see [“9.5. Ordering chart accessories” on page 19](#)).

The Bürkert Communicator enables:

- Configuration, parameterisation and diagnosis of EDIP devices / networks
- Easy and convenient assignment (mapping) of cyclical values
- Graphical display of process values
- Firmware update of the connected EDIP devices
- Saving and restoring device configurations

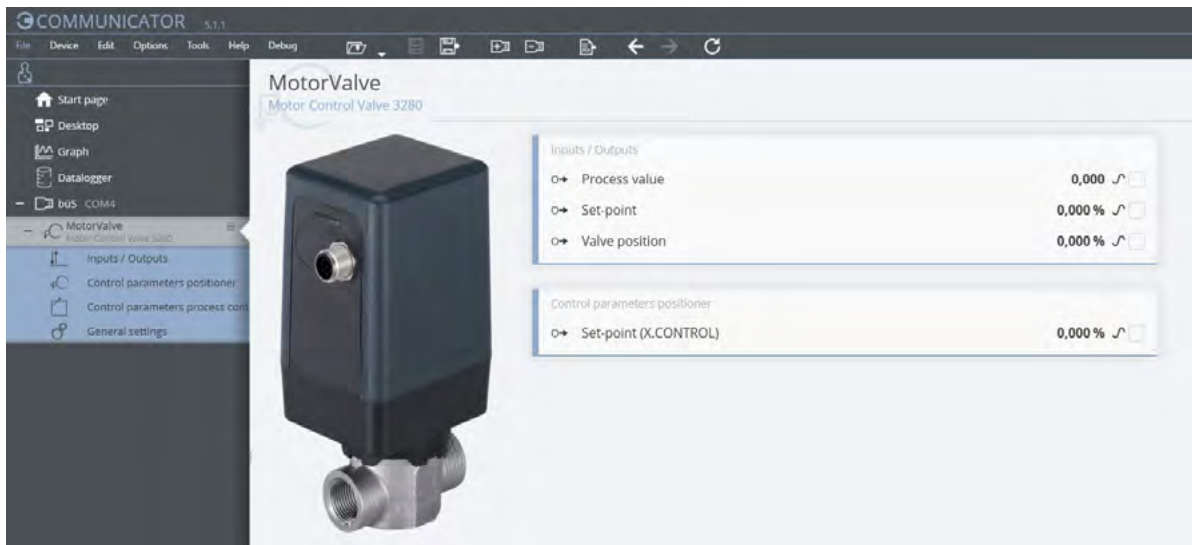

8.3. Connection Type 3280 with Bürkert Communicator software

The Bürkert Communicator interface is based on CANopen. An appropriate bus termination is mandatory. A bÜS stick is required to connect the motor valve to the Bürkert Communicator software tool. The USB-bÜS interface sets contains the necessary accessories.

- Variants with bÜS/CANopen communication interface:
 - Activate the switchable terminating resistor on the bÜS stick. Exception: if the device is already integrated in a properly terminated bus network, the terminating resistor must not be activated.
 - The connection is made directly via the 5-pin M12 plug (USB-bÜS interface set 1 contains the necessary accessories).
- Variants with standard signal interfaces:
 - Activate the switchable terminating resistor on the bÜS stick.
 - The connection is made via the 8-pin M12 plug on the device (USB-bÜS interface set 1 + bÜS adapter; socket 8-pin M12 to plug 5-pin M12 contain the necessary accessories).

9. Ordering information

9.1. Bürkert eShop



Bürkert eShop – Easy ordering and quick delivery

You want to find your desired Bürkert product or spare part quickly and order directly? Our online shop is available for you 24/7. Sign up and enjoy all the benefits.

[Order online now](#)

9.2. Recommendation regarding product selection

Note:

- The configuration of the seat size is very important for proportional valves to ensure proper functioning within the application. The seat size must be selected in such a way that on the one hand the desired flow range is achieved and on the other hand a sufficient part of the total pressure drop across the valve takes place when the valve is fully open.
- Reference value: pressure drop of the valve > 25 % of the total pressure drop
- Let Bürkert engineers advise you already in the planning phase.

9.3. Bürkert product filter



Bürkert product filter – Get quickly to the right product

You want to select products comfortably based on your technical requirements? Use the Bürkert product filter and find suitable articles for your application quickly and easily.

[Try out our product filter](#)

9.4. Bürkert Product Enquiry Form

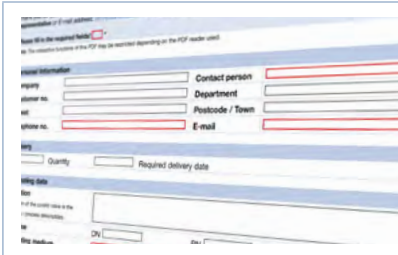

Bürkert Product Enquiry Form – Your enquiry quickly and compactly





Would you like to make a specific product enquiry based on your technical requirements? Use our Product Enquiry Form for this purpose. There you will find all the relevant information for your Bürkert contact. This will enable us to provide you with the best possible advice.

[Fill out the form now](#)



DTS 1000240084 EN Version: AK Status: RL (released | freigegeben | valide) printed: 24.03.2026

9.5. Ordering chart accessories

Standard accessories



Description	Article no.
Power supply unit Phoenix Class2 (Type 1573), 85...240 V AC/24 V DC, 1.25 A, NEC Class 2 (UL 1310)	772438 
Power supply unit for standard rail (Type 1573), 100...240 V AC/24 V DC, 1 A, NEC Class 2 (UL 1310)	772361 
Power supply unit for standard rail (Type 1573), 100...240 V AC/24 V DC, 2 A, NEC Class 2 (UL 1310)	772362 
Power supply unit for standard rail (Type 1573), 100...240 V AC/24 V DC, 3,8 A, NEC Class 2 (UL 60950 - 1)	772898 
Buffer module (Type 1573) for safety position in case of power failure	773440 



Accessories cable

Description	Article no.
M12 circular socket with cable, 8-pin, cable length: 2 m, ready-made cable for input and output signals (for analogue variant)	919061 
M12 circular socket with cable, 8-pin, cable length: 2 m, ready-made shielded cable for input and output signals (for analogue variant)	918991 
M12 cable shielded, 5-pin, cable length: 2 m, ready-made shielded cable for actual process value input signals (only for variant with analogue/digital process controller)	559177 

Bürkert accessories

Note:

- For connection to a bus/CANopen network, see „Supplement | Cabling guide bus/EDIP“ on our website under „User Manuals“, **Type 3280** .
- Detailed accessory tables can be found in the cabling guide „Supplement | Cabling guide bus/EDIP“ on our website under „User Manuals“, **Type 3280** .
- Can only be used with positioner and process controller variant

Description	Article no.
Software Bürkert Communicator	Type 8920 
büS adapter, M12 socket, 8-pin to M12 plug, 5-pin (for büS stick connection)	773286 
USB-büS interface set 1 (Type 8923) for connection to the Bürkert Communicator software: includes connection cable (M12 and micro USB), stick with integrated terminating resistor, power supply and software	772426 
USB-büS interface set 2 (Type 8923) for connection to the Bürkert Communicator software: including büS stick, connection cable to M12 plug, M12 connection cable on micro USB for the büS service interface and Y distributor, cable length: 0.7 m	772551 