



Direct-acting 2-way standard solenoid control valve

- Excellent range
- Very good response
- Compact valve design
- Orifice sizes 0.8...6 mm
- Optional: Explosion-protected coil

Product variants described in the data sheet may differ from the product presentation and description.

Can be combined with

	Type 8605 PWM control electronics for electromagnetic proportional valves	▶
	Type 2518 Cable plug, form A according to DIN EN 175301 - 803	▶
	Type 8611 eCONTROL - Universal controller	▶

Type description

The direct-acting solenoid control valve Type 2873 is used as the regulating unit in control loops. Due to an elastomeric seat seal the valve closes tight (integrated shut-off function), up to the DN specific nominal pressure. The plunger of the valve is assembled frictionless, which leads to an extraordinary adjustment characteristic. This valve is particularly suitable for demanding control tasks (high control range, dry gases, etc.).

DTS 1000593844 EN Version: B Status: RL (released | freigegeben | validé) printed: 25.10.2023

Table of contents

1. General technical data	3
2. Circuit functions	3
3. Approvals and conformities	4
3.1. General notes.....	4
3.2. Conformity	4
3.3. Standards.....	4
3.4. Explosion protection	4
3.5. North America (USA/Canada)	4
3.6. Foods and beverages/Hygiene	4
4. Materials	5
4.1. Bürkert resistApp	5
5. Dimensions	6
5.1. Threaded body.....	6
5.2. Sub-base body	7
5.3. ATEX/IECEx version	8
6. Performance specifications	8
6.1. Flow characteristic	8
Determination of the K_v value	8
6.2. Exemplary characteristic curve of a proportional valve	9
7. Product operation	9
7.1. Control unit	9
8. Ordering information	10
8.1. Bürkert eShop.....	10
8.2. Recommendation regarding product selection.....	10
8.3. Bürkert product filter	10
8.4. Bürkert Product Enquiry Form	10
8.5. Ordering chart.....	11
Standard version.....	11
Version with ATEX/IECEx approval	11
Version for higher differential pressures.....	12
Version for higher differential pressures with ATEX/IECEx approval.....	12
8.6. Ordering chart accessories.....	13
Cable plug Type 2518, form A according to DIN EN 175301 - 803	13
Control electronics Type 8605 for proportional valves	14

DTS 1000593844 EN Version: B Status: RL (released | freigegeben | validé) printed: 25.10.2023

1. General technical data

Product properties	
Dimensions	Further information can be found in chapter "5. Dimensions" on page 6.
Material	
Body	Brass, stainless steel
Seal	FKM, EPDM
Performance data	
Typical values of positioning behaviour ^{1.)}	
Hysteresis	< 5 %
Repeat accuracy	< 0.5 % of end value ^{2.)}
Response sensitivity	< 0.25 % of end value ^{2.)}
Setting range	1:200
Actuating time (10...90 %)	< 20 ms
Pressure range ^{3.)}	0...232 psi
Nominal operating mode	100 % continuous operation
Electrical data	
Operating voltage	24 V DC (at 5 W and 24 V coil) (12 V on request)
Power consumption	Max. 9 W
Maximum coil current ^{4.)}	420 mA (at 9 W and 24 V coil)
PWM frequency ^{5.)}	1200 Hz
Medium data	
Operating medium	Neutral gases, liquids on request
Medium temperature	+ 14 °F...+ 194 °F (with FKM) - 22 °F...+ 194 °F (with EPDM)
Viscosity	Max. 21 mm ² /s (21 cSt)
Process/Port connection & communication	
Port connection size	Sub-base, G 1/8, G 1/4, NPT 1/8, NPT 1/4, others on request
Electrical connection	Cable plug Type 2518 acc. to DIN EN 175301 - 803 form A Further information can be found in chapter "Cable plug Type 2518, form A according to DIN EN 175301 - 803" on page 13.
Approvals and conformities	
Degree of protection	IP65
Environment and installation	
Installation position	As required, preferably with actuator upright
Ambient temperature	Max. + 131 °F

- 1.) Characteristic data of control behaviour depends on process conditions
- 2.) By flow measurement
- 3.) Pressure data: overpressure to atmospheric pressure, depending on nominal diameter, tightness seal or nominal pressure
- 4.) Maximum value: value depends on operating pressure
- 5.) PWM: pulse width modulation

2. Circuit functions

Symbol	Description
	Circuit function A (CF A) 2/2-way solenoid proportional control valve Direct-acting Normally closed

DTS 1000593844 EN Version: B Status: RL (released | freigegeben | valide) printed: 25.10.2023

3. Approvals and conformities

3.1. General notes

- The approvals and conformities listed below must be stated when making enquiries. This is the only way to ensure that the product complies with all required specifications.
- Not all available versions can be supplied with the below mentioned approvals or conformities.

3.2. Conformity

In accordance with the Declaration of conformity, the product is compliant with the EU Directives.

3.3. Standards

The applied standards which are used to demonstrate compliance with the EU Directives are listed in the EU-Type Examination Certificate and/or the EU Declaration of Conformity.

3.4. Explosion protection

Approval	Description
 	Optional: Explosion protection ATEX: II 2 G Ex mb IIC T4...T5 Gb II 2 D Ex mb IIIC T130 °C Db IECEx: Ex mb IIC T4...T5 Gb Ex mb IIIC T130 °C Db

3.5. North America (USA/Canada)

Approval	Description
	Optional: UL Recognized for the USA The products are UL Recognized for the USA according to: <ul style="list-style-type: none"> • UL 429 (Electrically operated valves)

3.6. Foods and beverages/Hygiene

Conformity	Description
USP	United States Pharmacopeial Convention (USP) (valid for the variable code PL04) All wetted materials are biocompatible according to the manufacturer's declaration.
FDA	FDA – Code of Federal Regulations (valid for the variable code PL02, PL03) All wetted materials are compliant with the Code of Federal Regulations published by the FDA (Food and Drug Administration, USA) according to the manufacturer's declaration.
	EC Regulation 1935/2004 of the European Parliament and of the Council (valid for the variable code PL01, PL02) All wetted materials are compliant with EC Regulation 1935/2004/EC according to the manufacturer's declaration.

DTS 1000593844 EN Version: B Status: RL (released | freigegeben | valide) printed: 25.10.2023

4. Materials

4.1. Bürkert resistApp

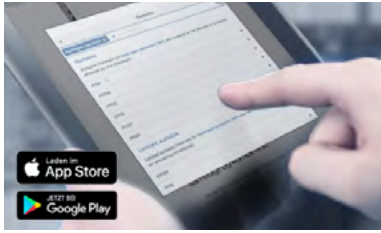

Bürkert resistApp – Chemical resistance chart

You want to ensure the reliability and durability of the materials in your individual application case? Verify your combination of media and materials on our website or in our resistApp.

[Start chemical resistance check](#)

5. Dimensions

5.1. Threaded version

Note:

Dimensions in mm [inch]

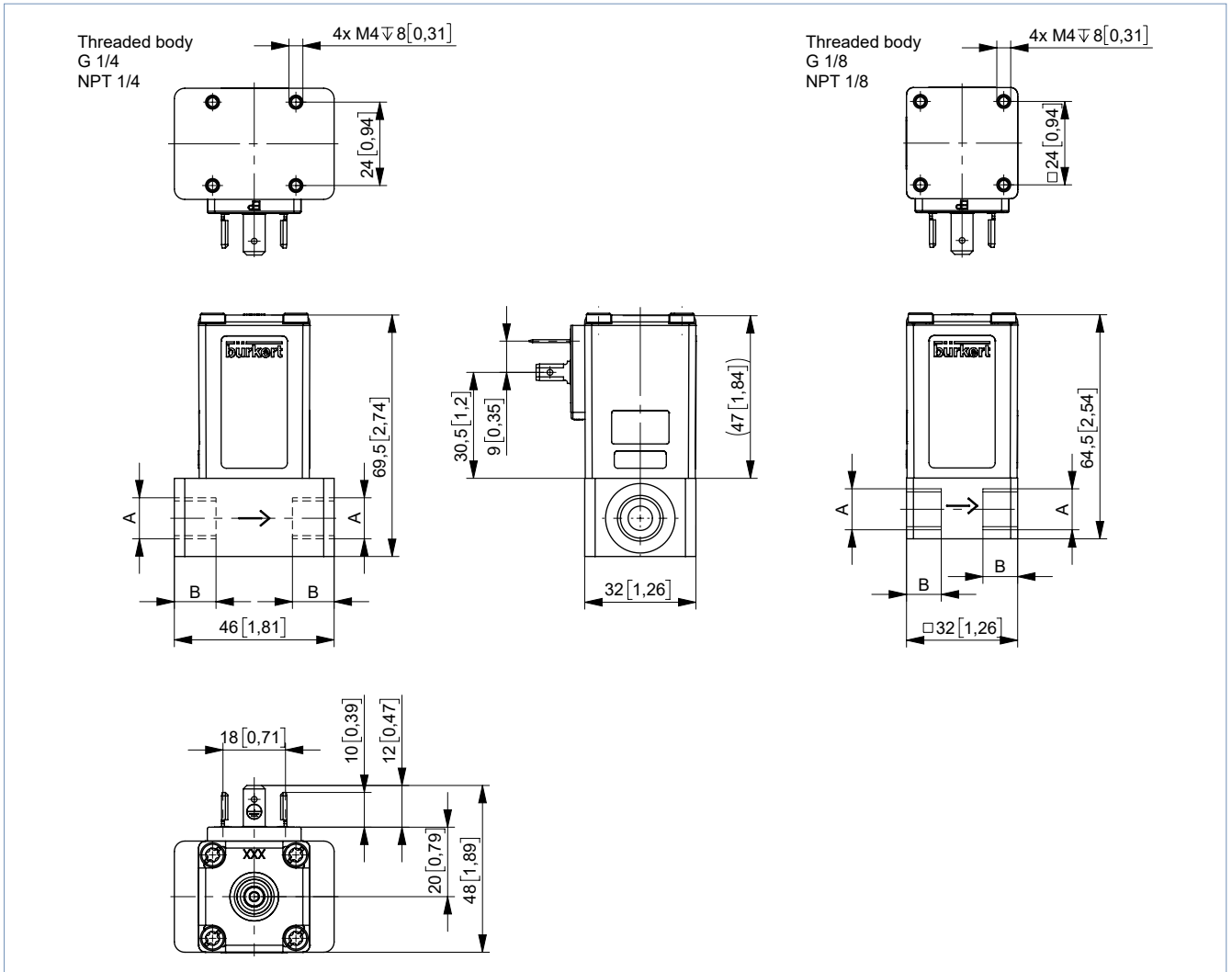

Port connection	A	B	
	[inch]	[mm]	[inch]
Thread	G 1/4	12	0.47
	G 1/8	8	0.31
	NPT 1/4	10	0.39
	NPT 1/8	7	0.28

5.2. Sub-base version

Note:

Dimensions in mm [inch]

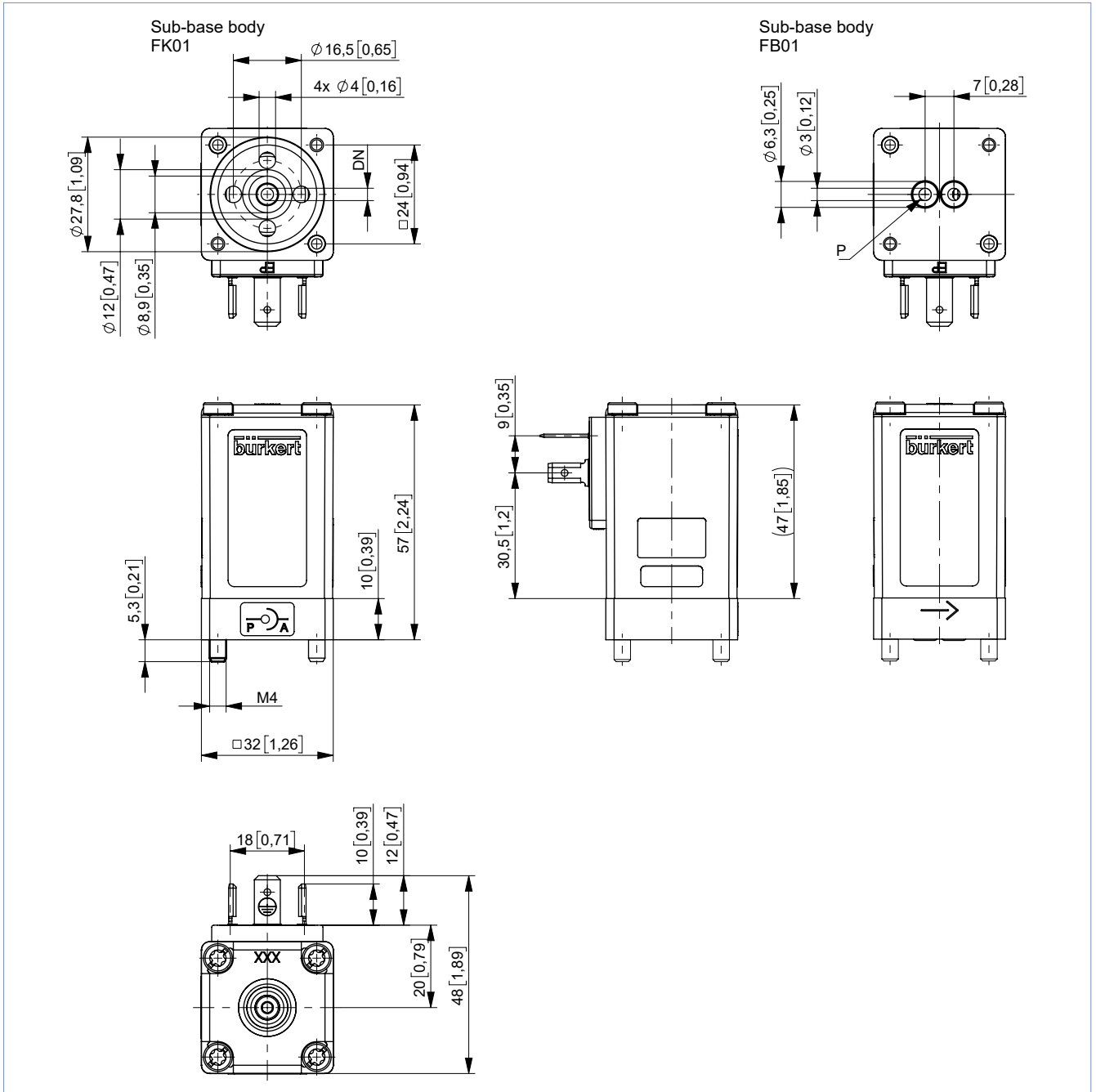

5.3. ATEX/IECEx version

Note:

Dimensions in mm [inch]

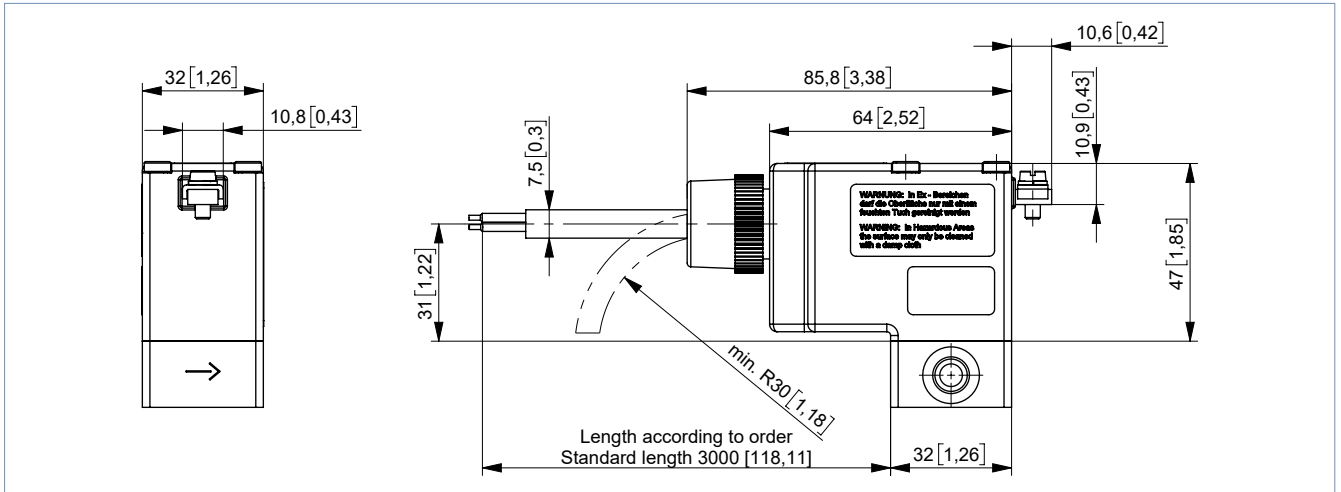

6. Performance specifications

6.1. Flow characteristic

Determination of the K_v value

Pressure drop	K_v value for liquids	K_v value for gases
	[m ³ /h]	[m ³ /h]
Sub-critical $p_2 > \frac{p_1}{2}$	$= Q \sqrt{\frac{\rho}{1000 \Delta p}}$	$= \frac{Q_N}{514} \sqrt{\frac{T_1 \rho_N}{p_2 \Delta p}}$
Supercritical $p_2 < \frac{p_1}{2}$	$= Q \sqrt{\frac{\rho}{1000 \Delta p}}$	$= \frac{Q_N}{257 p_1} \sqrt{T_1 \rho_N}$

- K_v Flow coefficient [m³/h]^{1,3}
- Q_N Standard flow rate [m³/h]^{2,3}
- p_1 Inlet pressure [bar]^{3,3}
- p_2 Outlet pressure [bar]^{3,3}
- Δp Differential pressure p_1, \dots, p_2 [bar]
- ρ Density [kg/m³]
- ρ_N Standard density [kg/m³]
- T_1 Medium temperature [(273+t)K]

- 1.) Measured for water, $\Delta p = 1$ bar, over the valve
- 2.) At reference conditions 1.013 bar and 0 °C (273 K)
- 3.) Absolute pressure

DTS 1000593844 EN Version: B Status: RL (released | freigegeben | valide) printed: 25.10.2023

6.2. Exemplary characteristic curve of a proportional valve

Note:

In continuous flow applications, the choice of an appropriate valve size is much more important than with on/off valves. The optimum size should be selected such that the resulting flow in the system is not unnecessarily reduced by the valve. However, a sufficient part of the pressure drop should be taken across the valve even when it is fully opened.

Reference value: $\Delta p_{\text{valve}} > 25\%$ of the total pressure drop

Otherwise, an ideal, linear valve characteristic is deformed into a curved system characteristic.

If the differential pressure (difference between inlet and outlet pressure) exceeds half the value of the nominal pressure discontinuities may occur.

For that reason take advantage of Bürkert competent engineering services during the planning phase.

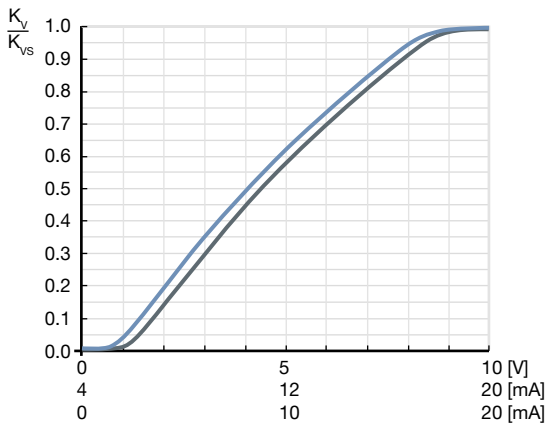

7. Product operation

7.1. Control unit

Valve control takes place through a PWM signal (pulse-width modulation). The duty cycle of the PWM signal determines the coil current and hence the position of the plunger.

The Bürkert control electronics Type 8605 (see data sheet **Type 8605** ▶) converts an analogue signal to a reference value corresponding to the valve type PWM signal and provides additional functions such as temperature compensation (coil heating), ramp function and the adjustment of min. and max. duty cycle/coil current for the control range.

Please note the sizing comments for such a control valve in chapter **“6.2. Exemplary characteristic curve of a proportional valve”** on [page 9](#).

DTS 1000593844 EN Version: B Status: RL (released | freigegeben | validé) printed: 25.10.2023

8. Ordering information

8.1. Bürkert eShop



Bürkert eShop – Easy ordering and quick delivery

You want to find your desired Bürkert product or spare part quickly and order directly? Our online shop is available for you 24/7. Sign up and enjoy all the benefits.

[Order online now](#)

8.2. Recommendation regarding product selection

Note:

- Use the product enquiry form (see “8.4. Bürkert Product Enquiry Form” on page 10) for information about the device layout and send it to us after completion.
- Please note the chapter “6.2. Exemplary characteristic curve of a proportional valve” on page 9 on product selection.

8.3. Bürkert product filter



Bürkert product filter – Get quickly to the right product

You want to select products comfortably based on your technical requirements? Use the Bürkert product filter and find suitable articles for your application quickly and easily.

[Try out our product filter](#)

8.4. Bürkert Product Enquiry Form

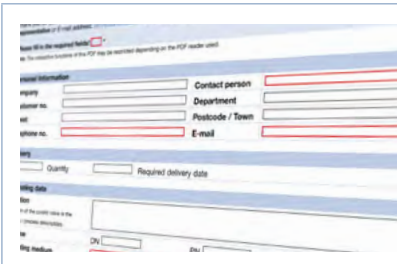

Bürkert Product Enquiry Form – Your enquiry quickly and compactly

Would you like to make a specific product enquiry based on your technical requirements? Use our Product Enquiry Form for this purpose. There you will find all the relevant information for your Bürkert contact. This will enable us to provide you with the best possible advice.

[Fill out the form now](#)

DTS 1000593844 EN Version: B Status: RL (released | freigegeben | validé) printed: 25.10.2023

8.5. Ordering chart

Standard version

Note:

- All valves with FKM seal and UL Recognized approval
- Please note that the cable plug must be ordered separately, see [“Cable plug Type 2518, form A according to DIN EN 175301 - 803” on page 13](#) or separate data sheet for **Type 2518** ▶.

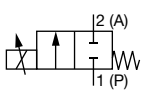
Circuit function	Port connection	Orifice	C _{vs} value water ^{1.)}	Nominal pressure ^{2.)} (MAWP ^{3.)})	Maximum differential pressure (MAOP ^{4.)})	Article no. Brass body	Article no. Stainless steel body
			[mm]	[gal/min]	[psi]		
CF A 2/2-way solenoid proportional control valve Direct-acting Normally closed 	Sub-base FK01	0.8	0.021	232	116	o. r.	o. r.
	NPT 1/8		0.021	232	116	274945 ☒	274961 ☒
	Sub-base FK01	1.2	0.046	174	87	o. r.	o. r.
	NPT 1/8		0.046	174	87	274947 ☒	274963 ☒
	Sub-base FK01	1.5	0.069	145	73	o. r.	o. r.
	NPT 1/8		0.069	145	73	274949 ☒	274965 ☒
	Sub-base FK01	2.0	0.116	116	58	o. r.	o. r.
	NPT 1/8		0.116	116	58	274951 ☒	274967 ☒
	NPT 1/4		0.116	116	58	274953 ☒	274969 ☒
	Sub-base FK01	2.5	0.173	73	36	o. r.	o. r.
	NPT 1/4		0.173	73	36	274955 ☒	274971 ☒
	Sub-base FK01	3.0	0.254	51	25	o. r.	o. r.
	NPT 1/4		0.254	51	25	274957 ☒	274973 ☒
	Sub-base FK01	4.0	0.370	29	15	o. r.	o. r.
	NPT 1/4		0.370	29	15	274959 ☒	274975 ☒

o. r. = on request

- 1.) Measurement at +68 °F, 14.5 psi pressure differential over a fully opened valve.
- 2.) Pressure data: overpressure to atmospheric pressure, with a differential pressure (difference between inlet and outlet pressure) above half of the nominal pressure there are discontinuities in the valve's characteristics possible.
- 3.) Maximum allowable working pressure
- 4.) Maximum allowable operating pressure

Version with ATEX/IECEx approval

Note:

- All valves with FKM seal and ATEX/IECEx version with 3 m connection cable.
- Other connection variants (Sub-base, G) or stainless steel body on request
- Refer to chapter [“3. Approvals and conformities” on page 4](#) for more information about the approvals.

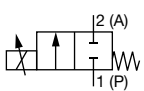
Circuit function	Port connection ^{1.)}	Orifice	C _{vs} -value water ^{2.)}	Nominal pressure ^{3.)} (MAWP ^{4.)})	Maximum differential pressure MAOP ^{5.)})	Article no. Brass body
			[mm]	[gal/min]	[psi]	
CF A 2/2-way solenoid proportional control valve Direct-acting Normally closed 	NPT 1/8	0.8	0.021	116	58	o. r.
	NPT 1/8	1.2	0.046	87	44	o. r.
	NPT 1/8	1.5	0.069	87	44	o. r.
	NPT 1/8	2.0	0.116	87	44	o. r.
	NPT 1/4		0.116	87	44	o. r.
	NPT 1/4	2.5	0.173	44	22	o. r.
	NPT 1/4	3.0	0.254	29	15	o. r.
	NPT 1/4	4.0	0.370	15	7	o. r.

o. r. = on request

- 1.) Port connection: others on request
- 2.) Measurement at +68 °F, 14.5 psi pressure differential over a fully opened valve.
- 3.) Pressure data: overpressure to atmospheric pressure. If the differential pressure between the inlet and outlet pressure of the valve is greater than half of the nominal pressure, discontinuities in the valve characteristic curve are possible.
- 4.) Maximum allowable working pressure
- 5.) Maximum allowable operating pressure

Version for higher differential pressures

Note:

- All valves with FKM seal and UL Recognized approval
- Other connection variants (Sub-base, NPT) on request
- PWM frequency 800 Hz
- Span 1:100
- Please note that the cable plug must be ordered separately, see [“Cable plug Type 2518, form A according to DIN EN 175301 - 803” on page 13](#) or separate data sheet for **Type 2518** ▶.

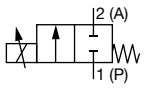
Circuit function	Port connection ^{1.)}	Orifice	C _{vs} -value water ^{2.)}	Nominal pressure ^{3.)} (MAWP ^{4.)})	Article no. Brass body	Article no. Stainless steel body
		[mm]	[gal/min]	[psi]		
CF A 2/2-way solenoid proportional control valve Direct-acting Normally closed 	NPT 1/8	0.8	0.021	232	o. r.	o. r.
	NPT 1/8	1.2	0.046	174	o. r.	o. r.
	NPT 1/8	1.5	0.069	145	o. r.	o. r.
	NPT 1/8	2.0	0.116	116	o. r.	o. r.
	NPT 1/4	2.5	0.173	73	o. r.	o. r.
	NPT 1/4	3.0	0.254	51	o. r.	o. r.
	NPT 1/4	4.0	0.370	29	288865	o. r.
	NPT 1/4	5.0	0.497	12	o. r.	o. r.
	NPT 1/4	6.0	0.671	7	o. r.	o. r.

o. r. = on request

1.) Port connection: others on request

2.) Measurement at +68 °F, 14.5 psi pressure differential over a fully opened valve.

3.) Pressure data: overpressure to atmospheric pressure. If the differential pressure between the inlet and outlet pressure of the valve is greater than half of the nominal pressure, discontinuities in the valve characteristic curve are possible.

4.) Maximum allowable working pressure

Version for higher differential pressures with ATEX/IECEx approval

Note:

- All valves with FKM seal and ATEX/IECEx version with 3 m connection cable.
- Other connection variants (Sub-base, G) or stainless steel body on request
- PWM frequency 800 Hz
- Span 1:100
- Refer to chapter [“3. Approvals and conformities” on page 4](#) for more information about the approvals.

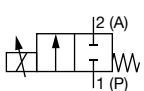
Circuit function	Port connection ^{1.)}	Orifice	C _{vs} -value water ^{2.)}	Nominal pressure ^{3.)} (MAWP ^{4.)})	Article no. Brass body
		[mm]	[gal/min]	[psi]	
CF A 2/2-way solenoid proportional control valve Direct-acting Normally closed 	NPT 1/8	0.8	0.021	116	o. r.
	NPT 1/8	1.2	0.046	87	o. r.
	NPT 1/8	1.5	0.069	87	o. r.
	NPT 1/8	2.0	0.116	87	o. r.
	NPT 1/4		0.116	87	o. r.
	NPT 1/4	2.5	0.173	44	o. r.
	NPT 1/4	3.0	0.254	29	o. r.
	NPT 1/4	4.0	0.370	15	o. r.

o. r. = on request

1.) Port connection: others on request

2.) Measurement at +68 °F, 14.5 psi pressure differential over a fully opened valve.

3.) Pressure data: overpressure to atmospheric pressure. If the differential pressure between the inlet and outlet pressure of the valve is greater than half of the nominal pressure, discontinuities in the valve characteristic curve are possible.

4.) Maximum allowable working pressure

DTS 1000593844 EN Version: B Status: RL (released | freigegeben | valide) printed: 25.10.2023

Further versions on request			
	Material Seal material FFKM Seal material EPDM		Analytical Oxygen version, parts oil-, fat- and silicon free
	Approval UR (UL recognized) ATEX/IECEX		Electrical connection 12 V Coil

8.6. Ordering chart accessories

Cable plug Type 2518, form A according to DIN EN 175301 - 803

Note:

For further versions see data sheet [Type 2518](#) ▶.



Cable plug	Dimensions	Version	Voltage	Article no.
		Without circuitry (AC/DC)	0...250 V AC/DC	314802

DTS 1000593844 EN Version: B Status: RL (released | freigegeben | validé) printed: 25.10.2023

Control electronics Type 8605 for proportional valves

Note:

Refer to data sheet **Type 8605** ▶ for more information about the control electronics.

Control electronics	Version	Max. coil current range [mA]	Voltage		Article no.
			24 V DC	12 V DC	
	Cable plug with PG cable gland	200...1000	o. r.	o. r.	316530
	Cable plug with M12 connection	200...1000	o. r.	o. r.	316528
	Cable plug with PG cable gland	500...2000	–	o. r.	316529
	Cable plug with M12 connection	500...2000	–	o. r.	316526
	Cable plug with PG cable gland without operating element	200...1000	o. r.	o. r.	316521
	Cable plug with M12 connection without operating element	200...1000	o. r.	o. r.	316522
	Cable plug with PG cable gland without operating element	500...2000	–	o. r.	316523
	Cable plug with M12 connection without operating element	500...2000	–	o. r.	316525
	Standard rail	200...1000	o. r.	o. r.	316532
	Standard rail	500...2000	–	o. r.	316533

o. r. = on request
 – = not available

DTS 1000593844 EN Version: B Status: RL (released | freigegeben | validé) printed: 25.10.2023