





Direct acting 2-way basic proportional valve

- High dynamics
- Orifice sizes DN 0.8 ... 4.0 mm
- Good range
- Optional: Explosion-protected coil



Product variants described in the data sheet may differ from the product presentation and description.

Can be combined with

	Type 8605 PWM control electronics for electromagnetic proportional valves	▶
	Type 2518 Cable plug, form A according to DIN EN 175301-803	▶
	Type 8611 eCONTROL – Universal controller	▶

Type description

Type 2863 is an extremely compact solenoid control valve and is available with an orifice up to 4mm. It is based on the standard version of Type 2873. It is used as an actuator in closed control loops (pressure, flow, temperature, etc.). Compared with the standard version, the valve is essentially of simpler construction and assembly and testing procedures are optimized, easing high volume series production with shorter delivery times.

DTS 1000614819 EN Version: RL (released | freigegeben | validé) printed: 05.03.2025

Table of contents

1. General technical data	3
2. Circuit functions	3
3. Approvals and conformities	4
3.1. General notes	4
3.2. Conformity	4
3.3. Standards	4
3.4. Explosion protection	4
4. Materials	4
4.1. Bürkert resistApp	4
5. Dimensions	5
5.1. Threaded version	5
5.2. Sub-base version	6
5.3. ATEX/IECEX version	7
6. Performance specifications	7
6.1. Flow characteristic	7
Determination of the K_v value	7
6.2. Exemplary characteristic curve of a proportional valve	8
7. Product operation	8
7.1. Control unit	8
8. Ordering information	8
8.1. Bürkert eShop	8
8.2. Recommendation regarding product selection	9
8.3. Bürkert product filter	9
8.4. Bürkert Product Enquiry Form	9
8.5. Ordering chart	9
Standard version	9
ATEX/IECEX version	10
8.6. Ordering chart accessories	10
Cable plug Type 2518, form A according to DIN EN 175301 - 803	10
Control electronics Type 8605 for proportional valves	11

1. General technical data

Product properties	
Dimensions	Further information can be found in chapter "5. Dimensions" on page 5.
Material	
Seal	FKM, EPDM
Body	Brass, stainless steel
Circuit function	A Further information can be found in chapter "2. Circuit functions" on page 3.
Performance data	
Typical values of positioning behaviour ¹⁾	
Hysteresis	< 5 %
Repeat accuracy	< 1 % of end value ²⁾
Response sensitivity	< 1 % of end value ²⁾
Setting range	1:25
Actuating time (10...90 %)	< 20 ms
Pressure range ³⁾	0...232 psi
Duty cycle	100 % continuous operation
Electrical data	
Operating voltage	24 V DC (12 V on request)
Power consumption	Max. 9 W
Maximum coil current ⁴⁾	420 mA (at 9 W and 24 V coil)
PWM frequency ⁵⁾	400 Hz
Medium data	
Operating medium	Neutral gases, liquids on request
Medium temperature	+ 14 °F...+ 194 °F (with FKM) - 22 °F...+ 194 °F (with EPDM)
Viscosity	Max. 21 mm ² /s (21 cSt)
Process/Port connection & communication	
Electrical connection	Plug contacts according to DIN EN 175301 - 803 form A for cable plug Type 2518 ▶. Further information can be found in chapter "Cable plug Type 2518, form A according to DIN EN 175301 - 803" on page 10.
Port connection	Sub-base, G 1/8, G 1/4, NPT 1/8, NPT 1/4
Approvals and conformities	
Degree of protection	IP65
Explosion protection	Further information can be found in chapter "3.4. Explosion protection" on page 4.
Environment and installation	
Installation position	As required, preferably with actuator upright
Ambient temperature	Max. + 131 °F

1.) Characteristic data of control behaviour depends on process conditions.

2.) By flow measurement

3.) Pressure data: overpressure with respect to atmospheric pressure, depending on nominal diameter, tightness seal or nominal pressure

4.) Maximum value: value depends on operating pressure

5.) PWM: pulse width modulation

2. Circuit functions

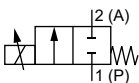
Symbol	Description
	Circuit function A (CF A) 2/2-way solenoid proportional control valve Direct-acting Normally closed

3. Approvals and conformities

3.1. General notes

- The approvals and conformities listed below must be stated when making enquiries. This is the only way to ensure that the product complies with all required specifications.
- Not all available versions can be supplied with the below mentioned approvals or conformities.



3.2. Conformity

In accordance with the Declaration of conformity, the product is compliant with the EU Directives.

3.3. Standards

The applied standards which are used to demonstrate compliance with the EU Directives are listed in the EU-Type Examination Certificate and/or the EU Declaration of Conformity.

3.4. Explosion protection

Approval	Description
	<p>Optional: Explosion protection</p> <p>As a category 2 device suitable for zone 1/21 and zone 2/22 (optional).</p>
	<p>ATEX: EPS 16 ATEX 1 121 X II 2 G Ex mb IIC T4...T5 Gb II 2 D Ex mb IIIC T130 °C Db</p> <p>IECEX: IECEX EPS 16.0053X Ex mb IIC T4...T5 Gb Ex mb IIIC T130 °C Db</p>

4. Materials

4.1. Bürkert resistApp

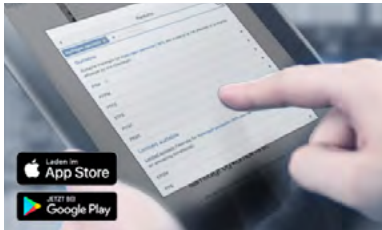

Bürkert resistApp – Chemical resistance chart

You want to ensure the reliability and durability of the materials in your individual application case? Verify your combination of media and materials on our website or in our resistApp.

Start chemical resistance check

DTS 1000614819 EN Version: D Status: RL (released | freigegeben | validé) printed: 05.03.2025

5. Dimensions

5.1. Threaded version

Note:

Dimensions in mm [inch]

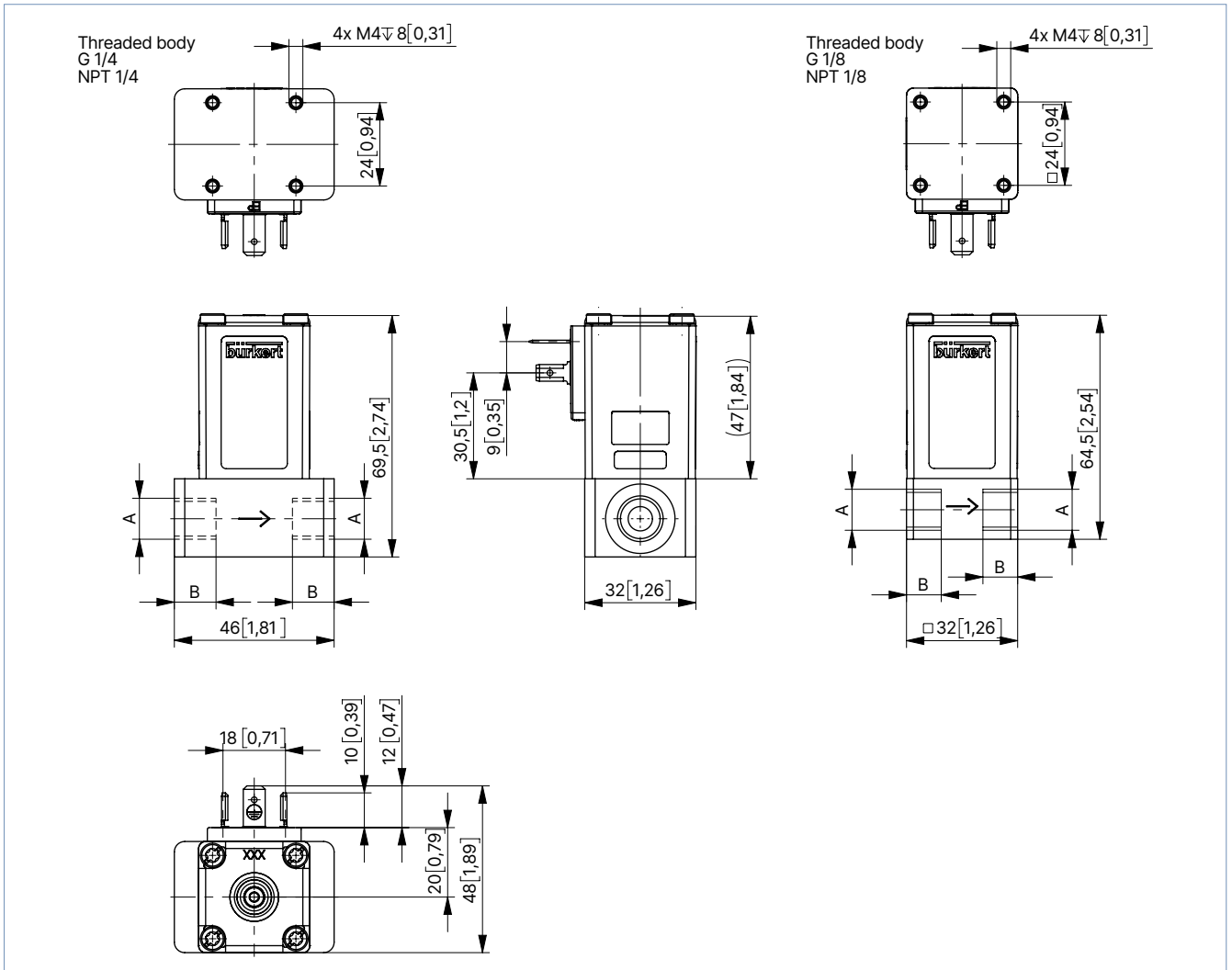

Port connection	A	B	
	[inch]	[mm]	[inch]
Thread	G ¼	12	0.47
	G ⅛	8	0.31
	NPT ¼	10	0.39
	NPT ⅛	7	0.28

5.2. Sub-base version

Note:

Dimensions in mm [inch]

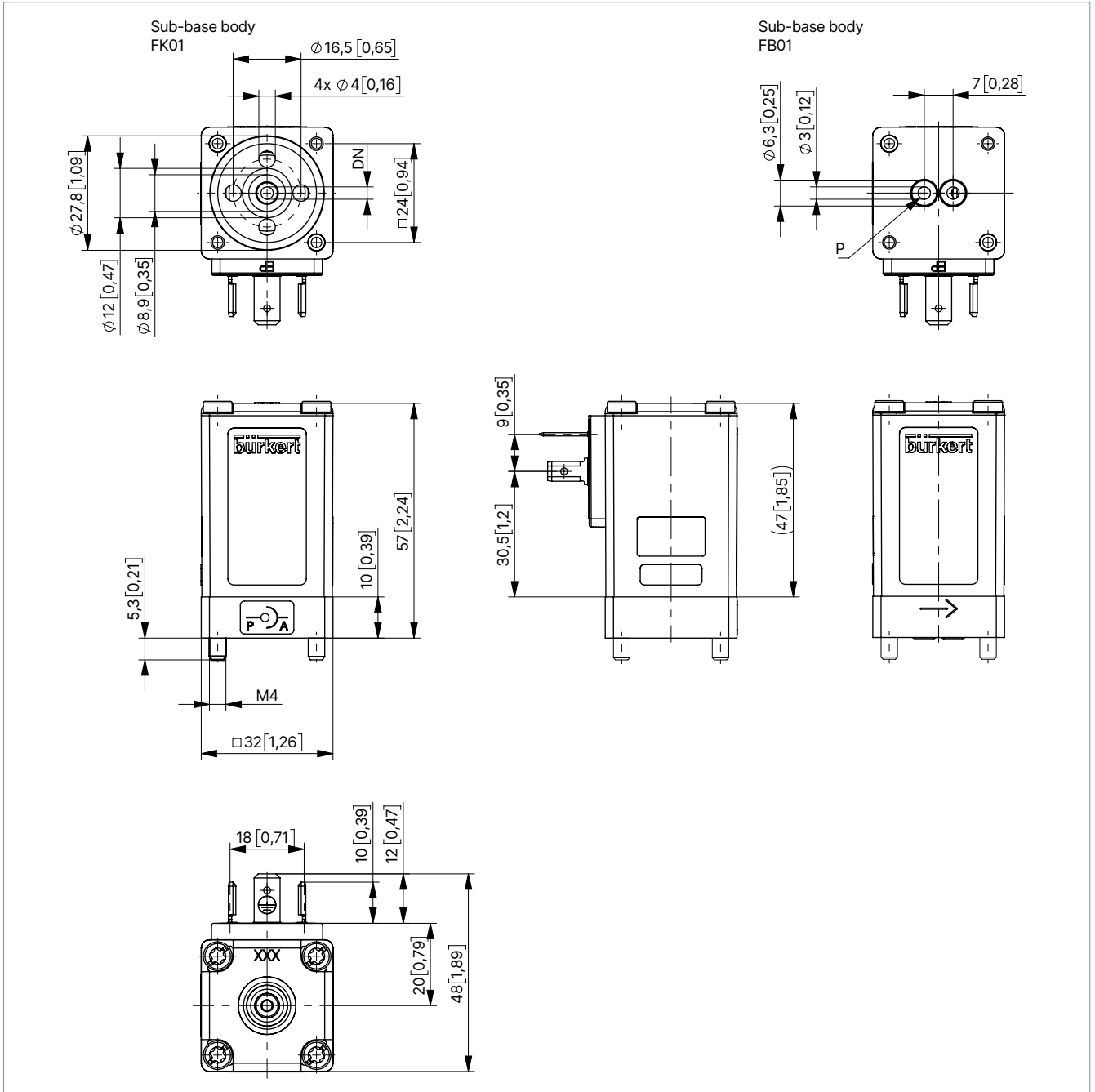

DTS 1000614819 EN Version: D Status: RL (released | freigegeben | valide) printed: 05.03.2025

5.3. ATEX/IECEx version

Note:

Dimensions in mm [inch]

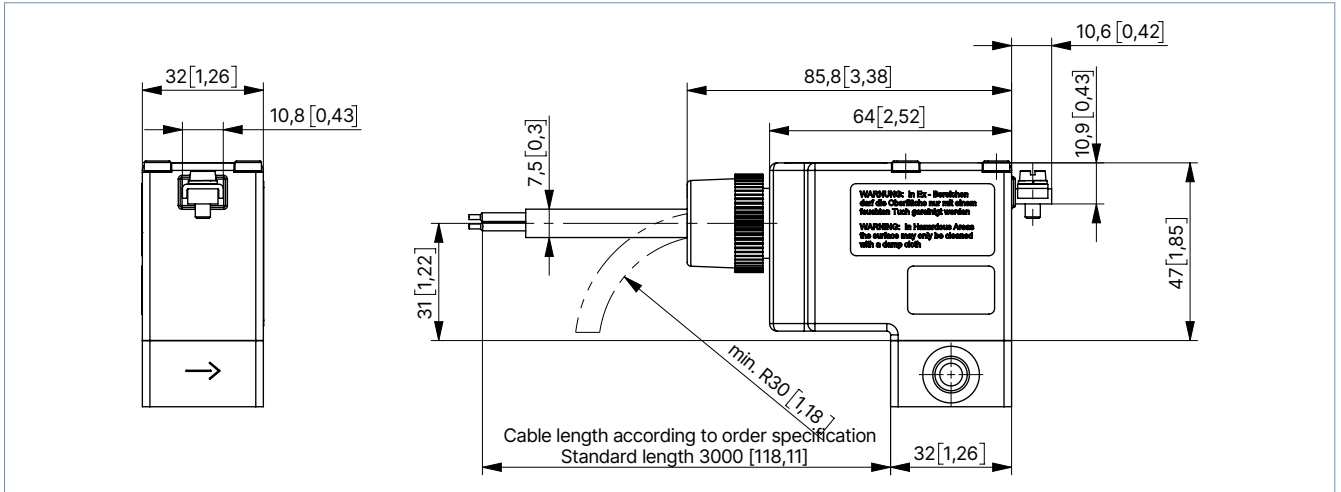

6. Performance specifications

6.1. Flow characteristic

Determination of the K_v value

Pressure drop	K_v value for liquids [m ³ /h]	K_v value for gases [m ³ /h]
Sub-critical $p_2 > \frac{p_1}{2}$	$= Q \sqrt{\frac{\rho}{1000 \Delta p}}$	$= \frac{Q_N}{514} \sqrt{\frac{T_1 \rho_N}{p_2 \Delta p}}$
Supercritical $p_2 < \frac{p_1}{2}$	$= Q \sqrt{\frac{\rho}{1000 \Delta p}}$	$= \frac{Q_N}{257 p_1} \sqrt{T_1 \rho_N}$

Value	Description	Unit
K_v	Flow coefficient	[m ³ /h] ^{1.)}
Q_N	Standard flow rate	[m ³ /h] ^{2.)}
p_1	Inlet pressure	[bar] ^{3.)}
p_2	Outlet pressure	[bar] ^{3.)}
Δp	Differential pressure p_1, \dots, p_2	[bar]
ρ	Density	[kg/m ³]
ρ_N	Standard density	[kg/m ³]
T_1	Medium temperature	[(273+t)K]

1.) Measured for water, $\Delta p = 1$ bar, over the value

2.) At reference conditions 1.013 bar and 0 °C (273 K)

3.) Absolute pressure

6.2. Exemplary characteristic curve of a proportional valve

Note:

In continuous flow applications, the choice of an appropriate valve size is much more important than with on/off valves. The optimum size should be selected such that the resulting flow in the system is not unnecessarily reduced by the valve. However, a sufficient part of the pressure drop should be taken across the valve even when it is fully opened.

Reference value: Δp valve > 25 % of the total pressure drop

Otherwise, an ideal, linear valve characteristic is deformed into a curved system characteristic.

If the differential pressure (difference between inlet and outlet pressure) exceeds half the value of the nominal pressure discontinuities may occur.

For that reason take advantage of Bürkert competent engineering services during the planning phase.

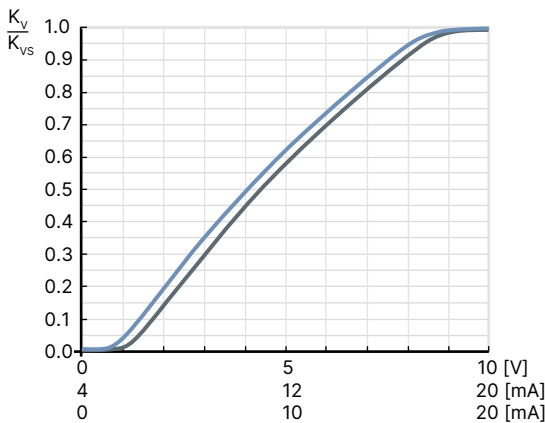

7. Product operation

7.1. Control unit

Valve control takes place through a PWM signal (pulse-width modulation). The duty cycle of the PWM signal determines the coil current and hence the position of the plunger.

The Bürkert control electronics Type 8605 (see data sheet **Type 8605** ▶) converts an analogue signal to a reference value corresponding to the valve type PWM signal and provides additional functions such as temperature compensation (coil heating), ramp function and the adjustment of min. and max. duty cycle/coil current for the control range.

Please note the sizing comments for such a control valve in chapter **“6.2. Exemplary characteristic curve of a proportional valve” on page 8.**

8. Ordering information

8.1. Bürkert eShop



Bürkert eShop – Easy ordering and quick delivery

You want to find your desired Bürkert product or spare part quickly and order directly? Our online shop is available for you 24/7. Sign up and enjoy all the benefits.

[Order online now](#)

DTS 1000614819 EN Version: D Status: RL (released | freigegeben | validé) printed: 05.03.2025

8.2. Recommendation regarding product selection

Note:

- Use the product enquiry form (see “8.4. Bürkert Product Enquiry Form” on page 9) for information about the device layout and send it to us after completion.
- Please note the chapter “6.2. Exemplary characteristic curve of a proportional valve” on page 8 on product selection.

8.3. Bürkert product filter



Bürkert product filter – Get quickly to the right product

You want to select products comfortably based on your technical requirements? Use the Bürkert product filter and find suitable articles for your application quickly and easily.

[Try out our product filter](#)

8.4. Bürkert Product Enquiry Form

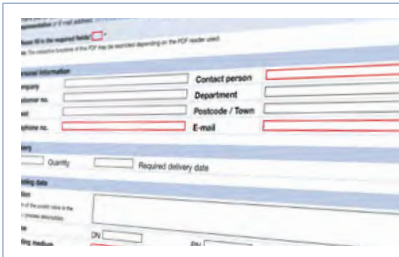

Bürkert Product Enquiry Form – Your enquiry quickly and compactly

Would you like to make a specific product enquiry based on your technical requirements? Use our Product Enquiry Form for this purpose. There you will find all the relevant information for your Bürkert contact. This will enable us to provide you with the best possible advice.

[Fill out the form now](#)

8.5. Ordering chart

Standard version

Note:

- All valves are delivered with FKM seal.
- Please note that the cable plug must be ordered separately, see “Cable plug Type 2518, form A according to DIN EN 175301 - 803” on page 10 or separate data sheet for **Type 2518** ▶.

Circuit function	Port connection ^{1.)}	Orifice	C _{vs} value water ^{2.)}	Nominal pressure ^{3.)} (MAWP ^{4.)})	Article no. Brass body	Article no. Stainless steel body
		[mm]	[gal/min]	[psi]		
CF A 2/2-way solenoid proportional control valve Direct-acting Normally closed 	NPT 1/8	0.8	0.021	232	o. r.	o. r.
	NPT 1/8	1.2	0.046	174	o. r.	o. r.
	NPT 1/8	1.5	0.069	145	o. r.	o. r.
	NPT 1/8	2.0	0.116	116	o. r.	o. r.
	NPT 1/4		0.116	116	o. r.	o. r.
	NPT 1/4	2.5	0.173	73	365596 𐀀	357124 𐀀
	NPT 1/4	3.0	0.254	51	365591 𐀀	o. r.
	NPT 1/4	4.0	0.370	29	o. r.	o. r.

o. r. = on request
 1.) G and sub-base on request
 2.) Measurement at + 68 °F, 14.5 psi pressure differential over a fully opened valve
 3.) Pressure data: overpressure with respect to atmospheric pressure
 4.) Maximum allowable working pressure

ATEX/IECEX version

Note:

- All valves are delivered with FKM seal.
- ATEX versions are delivered with a 3 m connection cable.
- Further information on ATEX and IECEX approvals can be found in chapter **“3. Approvals and conformities” on page 4.**
- Use the Product Enquiry Form (see **“8.4. Bürkert Product Enquiry Form” on page 9**) for information about the device layout and send it to us after completion.

Circuit function	Port connection ^{1.)}	Orifice	C _{vs} value water ^{2.)}	Nominal pressure ^{3.)} (MAWP ^{4.)})	Article no. Brass body	Article no. Stainless steel body
		[mm]	[gal/min]	[psi]		
CFA 2/2-way solenoid proportional control valve Direct-acting Normally closed 	NPT 1/8	0.8	0.021	116	o. r.	o. r.
	NPT 1/8	1.2	0.046	87	o. r.	o. r.
	NPT 1/8	1.5	0.069	87	o. r.	o. r.
	NPT 1/8	2.0	0.116	87	o. r.	20007388 𐀀
	NPT 1/4	2.5	0.173	36	o. r.	o. r.
	NPT 1/4	3.0	0.254	29	o. r.	o. r.
	NPT 1/4	4.0	0.370	15	o. r.	o. r.

o. r. = on request

1.) G and sub-base on request

2.) Measurement at + 68 °F, 14.5 psi pressure differential over a fully opened valve

3.) Pressure data: overpressure with respect to atmospheric pressure

4.) Maximum allowable working pressure

Further versions on request	
Material Other seal materials	Analytical Oxygen version, parts oil-, fat- and silicon free
Approval Further information can be found in chapter “3. Approvals and conformities” on page 4.	Orifice Special valve orifice
Coil Other coil power Specific, low-power setting for lower pressures Other operating voltages	

8.6. Ordering chart accessories

Cable plug Type 2518, form A according to DIN EN 175301 - 803

Note:

- Dimensions in mm
- For further versions see data sheet **Type 2518** ▶.



Cable plug	Dimensions	Version	Voltage	Article no.
		Without circuitry (AC/DC)	0...250 V AC/DC	314802 𐀀

DTS 1000614819 EN Version: D Status: RL (released | freigegeben | valide) printed: 05.03.2025

Control electronics Type 8605 for proportional valves

Note:

Refer to data sheet **Type 8605** ▶ for more information about the control electronics.

Control electronics	Version	Max. coil current range [mA]	Voltage		Article no.
			24 V/DC	12 V/DC	
	Cable plug with PG cable gland	200...1000	X	X	316530
	Cable plug with M12 connection	200...1000	X	X	316528
	Cable plug with PG cable gland	500...2000	-	X	316529
	Cable plug with M12 connection	500...2000	-	X	316526
	Cable plug with PG cable gland without operating element	200...1000	X	X	316521
	Cable plug with M12 connection without operating element	200...1000	X	X	316522
	Cable plug with PG cable gland without operating element	500...2000	-	X	316523
	Cable plug with M12 connection without operating element	500...2000	-	X	316525
	Standard rail	200...1000	X	X	316532
	Standard rail	500...2000	-	X	316533

X = available
- = not available

DTS 1000614819 EN Version: D Status: RL (released | freigegeben | valide) printed: 05.03.2025