





## Direct-acting 2-way basic proportional valve

- High dynamics
- Orifice sizes DN 0.8 ... 2.0 mm
- Good range

Product variants described in the data sheet may differ from the product presentation and description.

### Can be combined with

	<b>Type 8605</b> PWM control electronics for electromagnetic proportional valves	▶
	<b>Type 2507</b> Cable plug, form B according to industry standard	▶
	<b>Type 8611</b> eCONTROL - Universal controller	▶

### Type description

Type 2861 is an extremely compact solenoid control valve and is available with an orifice up to 2mm. It is based on the standard version of Type 2871. It is used as an actuator in closed control loops (pressure, flow, temperature, etc.). Compared with the standard version, the valve is essentially of simpler construction and assembly and testing procedures are optimized, easing high volume series production with shorter delivery times.

## Table of contents

<b>1. General technical data</b>	<b>3</b>
<b>2. Circuit functions</b>	<b>3</b>
<b>3. Approvals and conformities</b>	<b>4</b>
3.1. General notes .....	4
3.2. Conformity .....	4
3.3. Standards .....	4
3.4. Foods and beverages/Hygiene .....	4
3.5. Others .....	4
Oxygen .....	4
<b>4. Materials</b>	<b>4</b>
4.1. Bürkert resistApp .....	4
<b>5. Dimensions</b>	<b>5</b>
5.1. Threaded version .....	5
5.2. Sub-base version .....	6
<b>6. Performance specifications</b>	<b>7</b>
6.1. Flow characteristic .....	7
Determination of the $K_v$ value .....	7
6.2. Exemplary characteristic curve of a proportional valve .....	7
<b>7. Product operation</b>	<b>8</b>
7.1. Control unit .....	8
<b>8. Ordering information</b>	<b>8</b>
8.1. Bürkert eShop .....	8
8.2. Recommendation regarding product selection .....	8
8.3. Bürkert product filter .....	8
8.4. Bürkert Product Enquiry Form .....	8
8.5. Ordering chart .....	9
Standard version .....	9
8.6. Ordering chart accessories .....	10
Cable plug Type 2507, form B according to industry standard .....	10
Control electronics Type 8605 for proportional valves .....	10

## 1. General technical data

Product properties	
Dimensions	Further information can be found in chapter <a href="#">“5. Dimensions” on page 5.</a>
Material	
Seal	FKM, EPDM
Body	Brass, stainless steel
Circuit function	A Further information can be found in chapter <a href="#">“2. Circuit functions” on page 3.</a>
Performance data	
Typical values of positioning behaviour <sup>1.)</sup>	
Hysteresis	< 5 %
Repeat accuracy	< 1 % of end value <sup>2.)</sup>
Response sensitivity	< 1 % of end value <sup>2.)</sup>
Setting range	1:25
Actuating time (10...90 %)	< 15 ms
Pressure range <sup>3.)</sup>	0...174 psi
Nominal operating mode	100 % continuous operation
Electrical data	
Operating voltage	24 V/DC (12 V on request)
Power consumption	Max. 5 W
Maximum coil current <sup>4.)</sup>	220 mA (at 5 W and 24 V coil)
PWM frequency <sup>5.)</sup>	800 Hz
Medium data	
Operating medium	Neutral gases, liquids on request
Medium temperature	+ 14 °F...+ 194 °F (with FKM) - 22 °F...+ 194 °F (with EPDM)
Viscosity	Max. 21 mm <sup>2</sup> /s (21 cSt)
Process/Port connection & communication	
Electrical connection	Plug contacts according to DIN EN 175301 - 803 form B for cable plug <a href="#">Type 2507</a> ▶. Further information can be found in chapter <a href="#">“Cable plug Type 2507, form B according to industry standard” on page 10.</a>
Port connection	Sub-base, G 1/8, NPT 1/8
Approvals and conformities	
Degree of protection	IP65
Foods and beverages/Hygiene	Further information can be found in chapter <a href="#">“3.4. Foods and beverages/Hygiene” on page 4.</a>
Others	Further information can be found in chapter <a href="#">“3.5. Others” on page 4.</a>
Environment and installation	
Installation position	As required, preferably with actuator upright
Ambient temperature	Max. + 131 °F

- 1.) Characteristic data of control behaviour depends on process conditions.
- 2.) By flow measurement
- 3.) Pressure data: overpressure with respect to atmospheric pressure, depending on nominal diameter, tightness seal or nominal pressure
- 4.) Maximum value: value depends on operating pressure
- 5.) PWM: pulse width modulation

## 2. Circuit functions

Symbol	Description
	<b>Circuit function A (CF A)</b> 2/2-way solenoid proportional control valve Direct-acting Normally closed

DTS 1000614816 EN Version: - Status: RL (released | freigegeben | valide) printed: 17.04.2024

### 3. Approvals and conformities

#### 3.1. General notes

- The approvals and conformities listed below must be stated when making enquiries. This is the only way to ensure that the product complies with all required specifications.
- Not all available versions can be supplied with the below mentioned approvals or conformities.

#### 3.2. Conformity

In accordance with the Declaration of conformity, the product is compliant with the EU Directives.

#### 3.3. Standards

The applied standards which are used to demonstrate compliance with the EU Directives are listed in the EU-Type Examination Certificate and/or the EU Declaration of Conformity.

#### 3.4. Foods and beverages/Hygiene

Conformity	Description
FDA	<b>FDA – Code of Federal Regulations (valid for the variable code PL02, PL03)</b> All wetted materials are compliant with the Code of Federal Regulations published by the FDA (Food and Drug Administration, USA) according to the manufacturer’s declaration.
	<b>EC Regulation 1935/2004 of the European Parliament and of the Council (valid for the variable code PL01, PL02)</b> All wetted materials are compliant with EC Regulation 1935/2004/EC according to the manufacturer’s declaration.

#### 3.5. Others

##### Oxygen

Conformity	Description
	<b>Optional: Suitability for oxygen (valid for the variable code NL02)</b> The products are suitable for use with gaseous oxygen, according to the manufacturer’s declaration.

### 4. Materials

#### 4.1. Bürkert resistApp

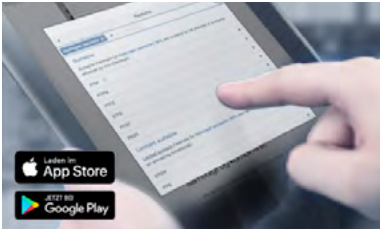

**Bürkert resistApp – Chemical resistance chart**

You want to ensure the reliability and durability of the materials in your individual application case? Verify your combination of media and materials on our website or in our resistApp.

[Start chemical resistance check](#)

DTS 1000614816 EN Version: - Status: RL (released | freigegeben | validé) printed: 17.04.2024

## 5. Dimensions

### 5.1. Threaded version

**Note:**

Dimensions in mm [inch]

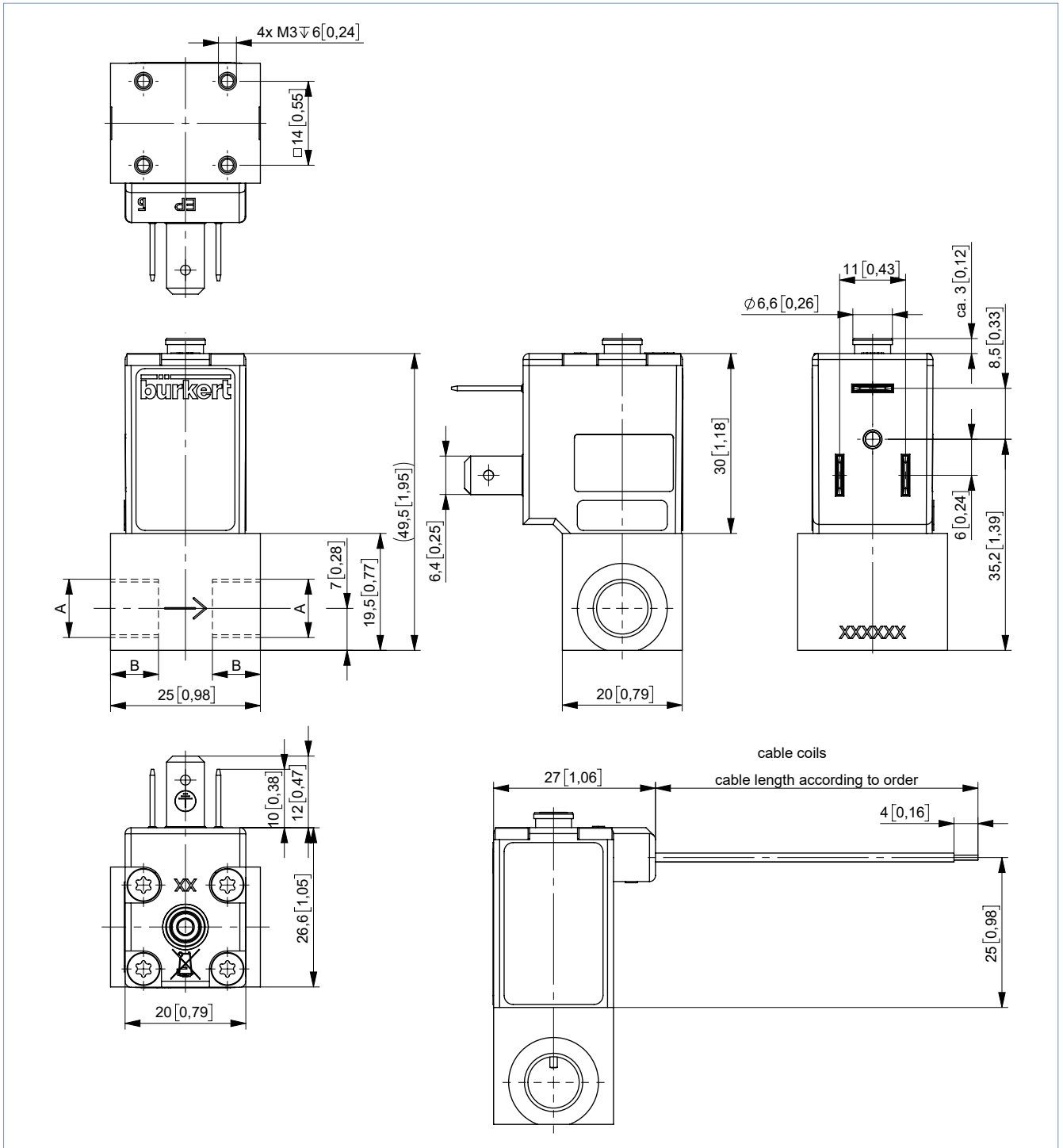

Port connection	A	B	
	[inch]	[mm]	[inch]
Thread	G 1/8	8	0.31
	NPT 1/8	7	0.28

5.2. Sub-base version

Note:

Dimensions in mm [inch]

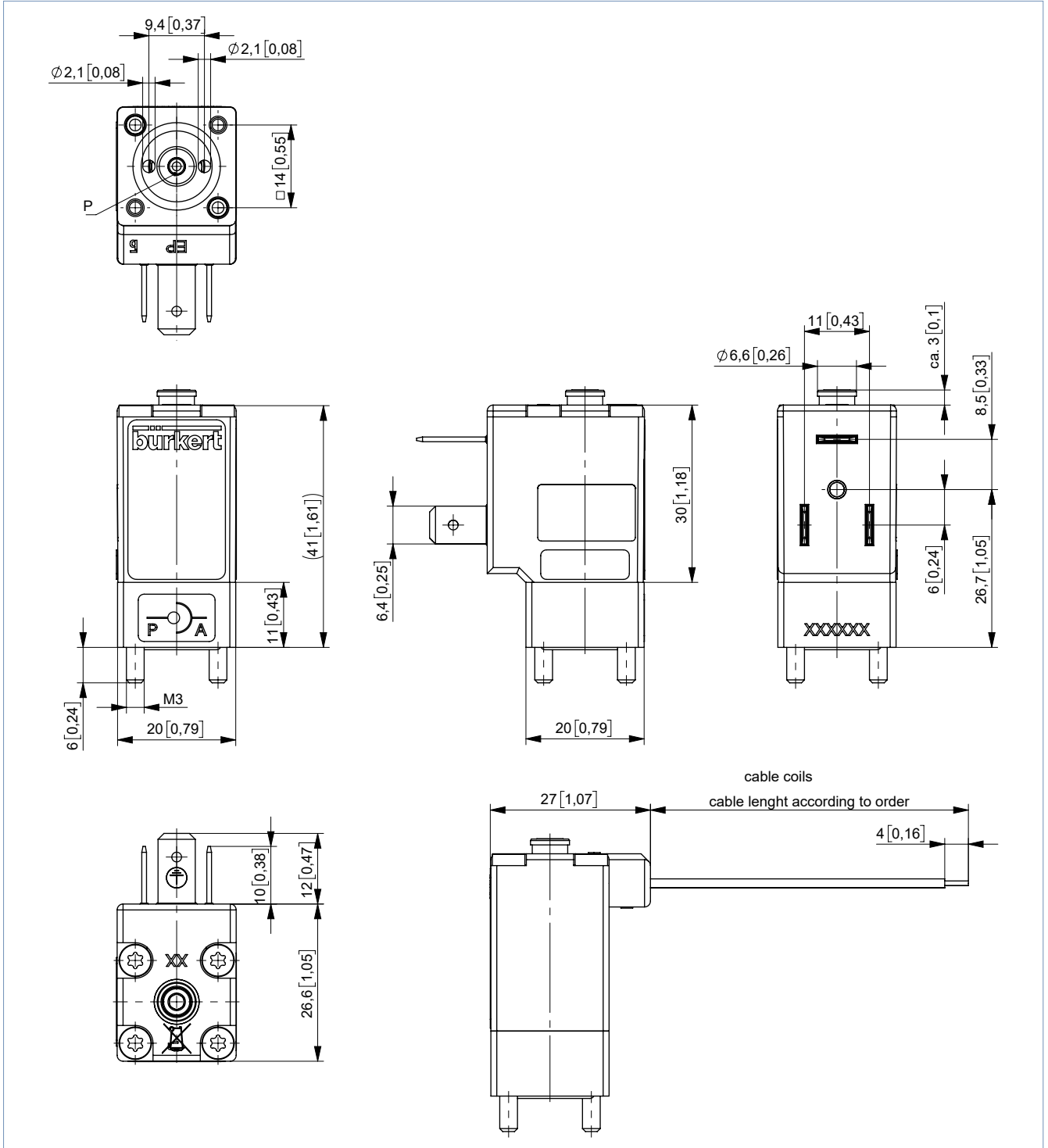

## 6. Performance specifications

### 6.1. Flow characteristic

Determination of the  $K_v$  value

Pressure drop	$K_v$ value for liquids [m <sup>3</sup> /h]	$K_v$ value for gases [m <sup>3</sup> /h]
Sub-critical $p_2 > \frac{p_1}{2}$	$= Q \sqrt{\frac{\rho}{1000 \Delta p}}$	$= \frac{Q_N}{514} \sqrt{\frac{T_1 \rho_N}{p_2 \Delta p}}$
Supercritical $p_2 < \frac{p_1}{2}$	$= Q \sqrt{\frac{\rho}{1000 \Delta p}}$	$= \frac{Q_N}{257 p_1} \sqrt{T_1 \rho_N}$

$K_v$	Flow coefficient	[m <sup>3</sup> /h] <sup>1,3</sup>
$Q_N$	Standard flow rate	[m <sup>3</sup> /h] <sup>2,3</sup>
$p_1$	Inlet pressure	[bar] <sup>3,3</sup>
$p_2$	Outlet pressure	[bar] <sup>3,3</sup>
$\Delta p$	Differential pressure $p_1 \dots p_2$	[bar]
$\rho$	Density	[kg/m <sup>3</sup> ]
$\rho_N$	Standard density	[kg/m <sup>3</sup> ]
$T_1$	Medium temperature	[(273+t)K]

- 1.) Measured for water,  $\Delta p = 1$  bar, over the valve
- 2.) At reference conditions 1.013 bar and 0 °C (273 K)
- 3.) Absolute pressure

### 6.2. Exemplary characteristic curve of a proportional valve

**Note:**

In continuous flow applications, the choice of an appropriate valve size is much more important than with on/off valves. The optimum size should be selected such that the resulting flow in the system is not unnecessarily reduced by the valve. However, a sufficient part of the pressure drop should be taken across the valve even when it is fully opened.

Reference value:  $\Delta p_{\text{valve}} > 25\%$  of the total pressure drop

Otherwise, an ideal, linear valve characteristic is deformed into a curved system characteristic.

If the differential pressure (difference between inlet and outlet pressure) exceeds half the value of the nominal pressure discontinuities may occur.

For that reason take advantage of Bürkert competent engineering services during the planning phase.

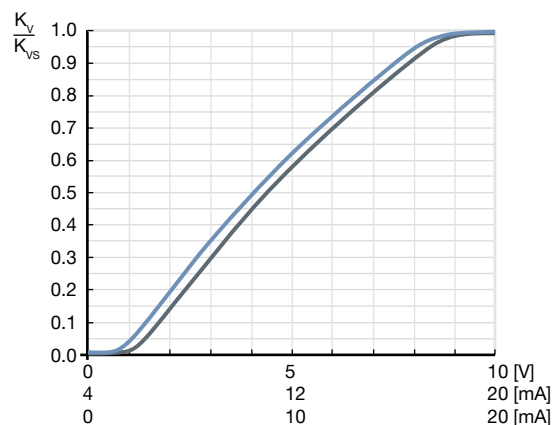

DTS 1000614816 EN Version: - Status: RL (released | freigegeben | validé) printed: 17.04.2024

## 7. Product operation

### 7.1. Control unit

Valve control takes place through a PWM signal (pulse-width modulation). The duty cycle of the PWM signal determines the coil current and hence the position of the plunger.

The Bürkert control electronics Type 8605 (see data sheet **Type 8605** ▶) converts an analogue signal to a reference value corresponding to the valve type PWM signal and provides additional functions such as temperature compensation (coil heating), ramp function and the adjustment of min. and max. duty cycle/coil current for the control range.

Please note the sizing comments for such a control valve in chapter **“6.2. Exemplary characteristic curve of a proportional valve”** on page 7.

## 8. Ordering information

### 8.1. Bürkert eShop



#### Bürkert eShop – Easy ordering and quick delivery

You want to find your desired Bürkert product or spare part quickly and order directly? Our online shop is available for you 24/7. Sign up and enjoy all the benefits.

[Order online now](#)

### 8.2. Recommendation regarding product selection

#### Note:

- Use the product enquiry form (see **“8.4. Bürkert Product Enquiry Form”** on page 8) for information about the device layout and send it to us after completion.
- Please note the chapter **“6.2. Exemplary characteristic curve of a proportional valve”** on page 7 on product selection.

### 8.3. Bürkert product filter



#### Bürkert product filter – Get quickly to the right product

You want to select products comfortably based on your technical requirements? Use the Bürkert product filter and find suitable articles for your application quickly and easily.

[Try out our product filter](#)

### 8.4. Bürkert Product Enquiry Form

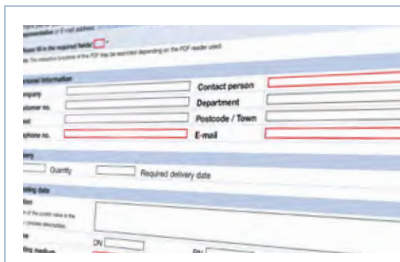

#### Bürkert Product Enquiry Form – Your enquiry quickly and compactly

Would you like to make a specific product enquiry based on your technical requirements? Use our Product Enquiry Form for this purpose. There you will find all the relevant information for your Bürkert contact. This will enable us to provide you with the best possible advice.

[Fill out the form now](#)



### 8.5. Ordering chart

#### Standard version

**Note:**

- All valves are delivered with FKM seal.
- Please note that the cable plug must be ordered separately, see “Cable plug Type 2507, form B according to industry standard” on page 10 or separate data sheet for Type 2507 ▶.

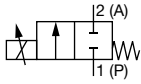
Circuit function	Port connection <sup>1.)</sup>	Orifice	C <sub>vs</sub> value water <sup>2.)</sup>	Nominal pressure <sup>3.)</sup> (MAWP <sup>4.)</sup> )	Article no. Brass body	Article no. Stainless steel body
		[mm]	[gal/min]	[psi]		
<b>CF A</b> 2/2-way solenoid proportional control valve Direct-acting Normally closed 	Sub-base FK01	0.8	0.021	174	255637	275076
	NPT 1/8		0.021	174	255639	o. r.
	Sub-base FK01	1.0	0.031	145	275073	275077
	NPT 1/8		0.031	145	o. r.	o. r.
	Sub-base FK01	1.2	0.044	116	275074	275078
	NPT 1/8		0.044	116	268387	o. r.
	Sub-base FK01	1.6	0.064	87	249009	275079
	NPT 1/8		0.064	87	281088	o. r.
	Sub-base FK01	2.0	0.104	44	275075	275080
	NPT 1/8		0.104	44	o. r.	o. r.

o. r. = on request





1.) G on request

2.) Measurement at +68 °F, 14.5 psi pressure differential over a fully opened valve

3.) Pressure data: overpressure with respect to atmospheric pressure

4.) Maximum allowable working pressure

#### Further versions on request

 <b>Material</b> Seal material FFKM Seal material EPDM	 <b>Analytical</b> Oxygen version, Parts oil-, fat- and silicon free
 <b>Coil</b> Other coil power Specific, low-power setting for lower pressures Other operating voltages Coil with flying leads	 <b>Process connection</b> Special valve orifice

### 8.6. Ordering chart accessories

#### Cable plug Type 2507, form B according to industry standard

**Note:**

- Dimensions in mm
- Delivery of cable plug includes a flat seal and a fixing screw.
- Refer to data sheet **Type 2507** ▶ for more information about the cable plug.

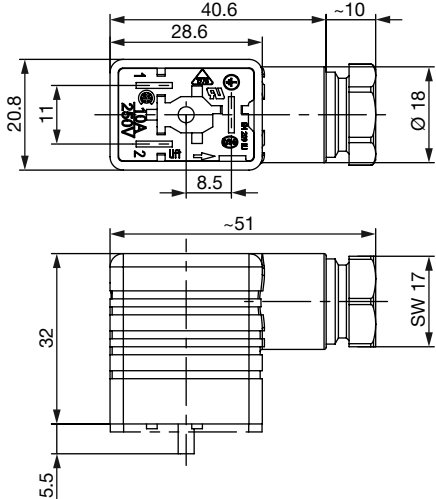
Cable plug	Dimensions	Version	Voltage	Article no.
		Without circuitry (standard)	2...250 V AC/DC	423845

#### Control electronics Type 8605 for proportional valves

**Note:**

Refer to data sheet **Type 8605** ▶ for more information about the control electronics.

Control electronics	Version	Max. coil current range [mA]	Voltage		Article no.
			24 V/DC	12 V/DC	
	Standard rail	40...220	o. r.	–	316531
	Standard rail	200...1000	o. r.	o. r.	316532

o. r. = on request  
– = not available

DTS 1000614816 EN Version: - Status: RL (released | freigegeben | valide) printed: 17.04.2024