



2-way proportional valve with pressure compensation

- Excellent span
- Very compact design for easy use in electronic devices
- Flange and plug-in connection for integration into valve manifolds
- Reduced power consumption
- Operating pressure up to 7 bar(g)

Product variants described in the data sheet may differ from the product presentation and description.

Can be combined with

	Type 6724 ▶ 2/2 or 3/2-way Whisper Valve with media separation
	Type 7011 ▶ Direct-acting 2/2-way plunger valve
	Type 6624 ▶ 2/2 and 3/2-way Bürkert TwinPower rocker solenoid valve with separating diaphragm

Type description

The new proportional valve 2852 is pressure-compensated and therefore offers a high pressure level with low power consumption at the same time. The total dimensions of this valve were kept low with regards to integration in devices where compactness and low heating are required for each individual valve, while it still offers comparatively high flow rates. The valve is designed for installation in analytical and medical devices, but can also be used in similar applications in other markets. It possesses two kinds of mechanical integration and three different electrical connection types (wires, plug and soldered contacts) that support all good integration options in mechatronic systems.

Table of contents

1. General technical data	3
2. Circuit functions	3
3. Approvals and conformities	4
3.1. General notes.....	4
3.2. Conformity	4
3.3. Standards.....	4
3.4. Foods and beverages/Hygiene	4
3.5. Others	4
Oxygen.....	4
Fuel gases.....	4
4. Materials	4
4.1. Bürkert resistApp	4
5. Dimensions	5
5.1. Flange version.....	5
5.2. Cartridge version.....	6
6. Device/Process connections	7
6.1. Pin assignment flange version	7
6.2. Pin assignment cartridge version.....	7
7. Performance specifications	8
7.1. Flow characteristic.....	8
Flow characteristics as a function of the coil current	8
Maximum flow rate as a function of the operating pressure.....	8
Determination of the K_v value	9
8. Product operation	9
8.1. Control unit	9
9. Ordering information	10
9.1. Bürkert eShop.....	10
9.2. Recommendation regarding product selection.....	10
9.3. Bürkert product filter	10
9.4. Bürkert Product Enquiry Form	10
9.5. Ordering chart	11
Standard version.....	11
9.6. Ordering chart accessories.....	11
Manifolds	11
Further accessories.....	11

1. General technical data

Product properties	
Dimensions	Further information can be found in chapter “5. Dimensions” on page 5.
Material	
Seal	FKM
Wetted materials	Stainless steel 1.4113/1.4310/1.4305, PPS GF40
Circuit functions	A Further information can be found in chapter “2. Circuit functions” on page 3.
Performance data	
Typical values of positioning behaviour ^{1.)}	
Hysteresis	< 15 %
Repeat accuracy	< 1 % FS ^{2.)}
Response sensitivity	< 0.1 % FS ^{2.)}
Setting range	> 1:500
Actuating time	< 10 ms ^{3.)}
Pressure range ^{4.)}	0...7 bar
K _{vs} value	0.2 m ³ /h (measured with air, without back pressure)
Leakage	External: < 1 ml/min (air) Internal: < 1 ml/min (air)
Electrical data	
Operating voltage	12 V/DC, 24 V/DC
Power consumption	2.8 W (max. 3.4 W)
Maximum coil current	280 mA with 12 V coil 140 mA with 24 V coil
Valve control	PWM frequency ^{5.)} > 2000 Hz or DC voltage with constant current control
Medium data	
Operating medium	Gases Further information about checking the chemical resistance of the wetted materials can be found in chapter “4.1. Bürkert resistApp” on page 4.
Medium temperature	+ 5 °C...+ 50 °C
Process/Port connection & communication	
Electrical connection	300 mm flying leads, JST plug
Port connection	Flange, cartridge
Approvals and conformities	
Degree of protection	IP50 (flying leads version), IP10 (JST plug)
Foods and beverages/Hygiene	Further information can be found in chapter “3.4. Foods and beverages/Hygiene” on page 4.
Others	Further information can be found in chapter “3.5. Others” on page 4.
Environment and installation	
Installation position	As required, preferably with actuator upright
Ambient temperature	+ 5...+ 50 °C

- 1.) Characteristic data of positioning behaviour depends on process conditions.
- 2.) For flow measurement
- 3.) Determined according to DIN ISO 12238
- 4.) Pressure data: overpressure to atmospheric pressure, tightness seal pressure or nominal pressure
- 5.) PWM: pulse width modulation

2. Circuit functions

Symbol	Description
	Circuit function A (CF A) 2/2-way solenoid proportional control valve Direct-acting Normally closed

DTS 1000597991 EN Version: B Status: RL (released | freigegeben | valide) printed: 27.06.2024

3. Approvals and conformities

3.1. General notes

- The approvals and conformities listed below must be stated when making enquiries. This is the only way to ensure that the product complies with all required specifications.
- Not all available versions can be supplied with the below mentioned approvals or conformities.

3.2. Conformity

In accordance with the Declaration of Conformity, the product is compliant with the EU Directives.

3.3. Standards

The applied standards which are used to demonstrate compliance with the EU Directives are listed in the EU-Type Examination Certificate and/or the EU Declaration of Conformity.

3.4. Foods and beverages/Hygiene

Conformity	Description
USP	United States Pharmacopeial Convention (USP) (valid for the variable code PL04) All wetted materials are biocompatible according to the manufacturer's declaration.

3.5. Others

Oxygen

Conformity	Description
O ₂	Optional: Suitability for oxygen (valid for the variable code NL02) The products are suitable for use with gaseous oxygen, according to the manufacturer's declaration.

Fuel gases

Conformity	Description
	Optional: DIN EN 549:2023-07 certification The wetted valve seals, which seal against the environment, are compliant with DIN EN 549:2023-07 (Rubber materials for seals and diaphragms for gas appliances and gas equipment) for medium temperatures of 0 °C...+125 °C.

4. Materials

4.1. Bürkert resistApp

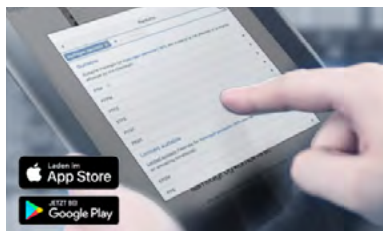

Bürkert resistApp – Chemical resistance chart

You want to ensure the reliability and durability of the materials in your individual application case? Verify your combination of media and materials on our website or in our resistApp.

[Start chemical resistance check](#)

5. Dimensions

5.1. Flange version

Note:

Dimensions in mm

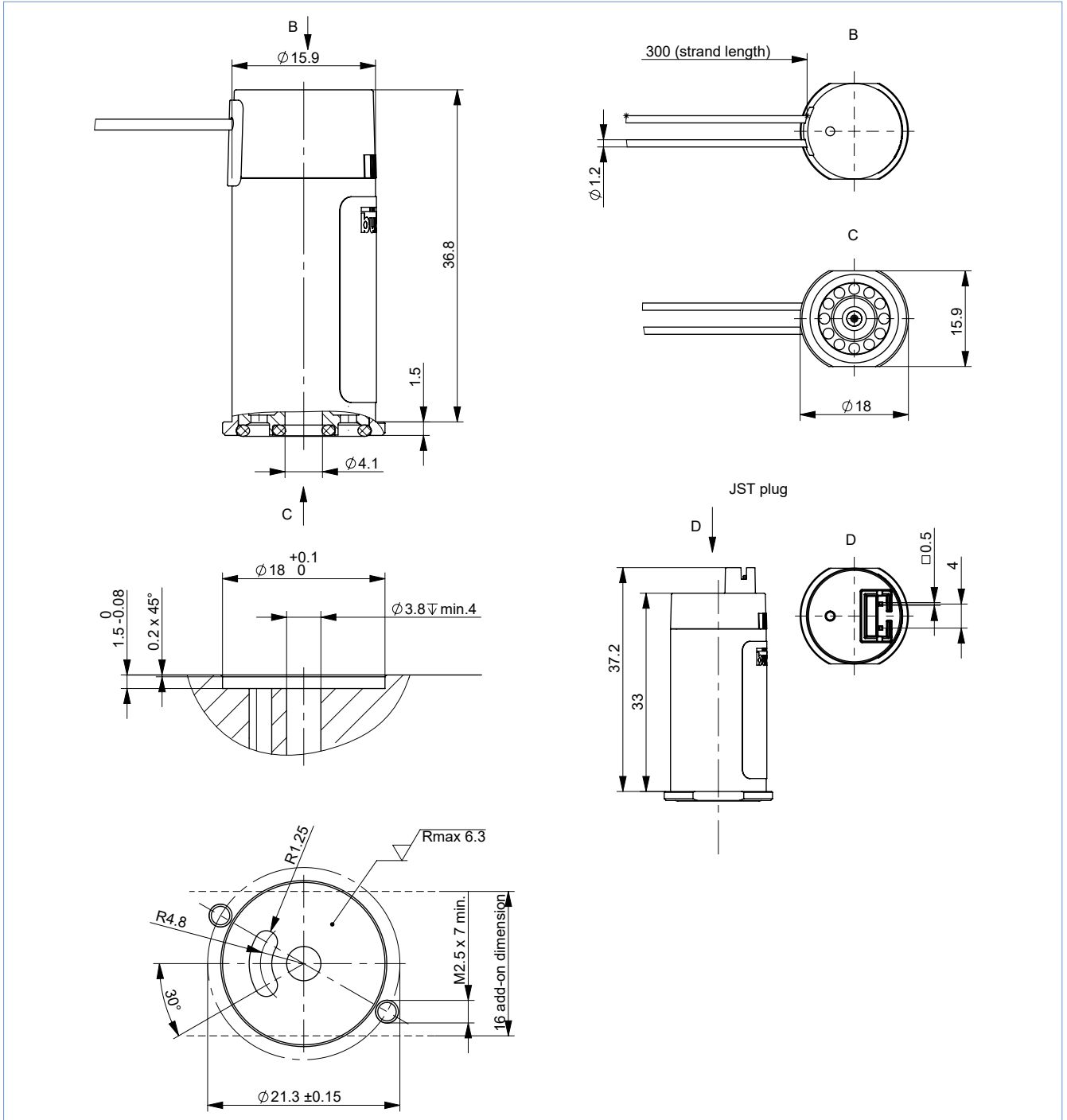

5.2. Cartridge version

Note:
Dimensions in mm

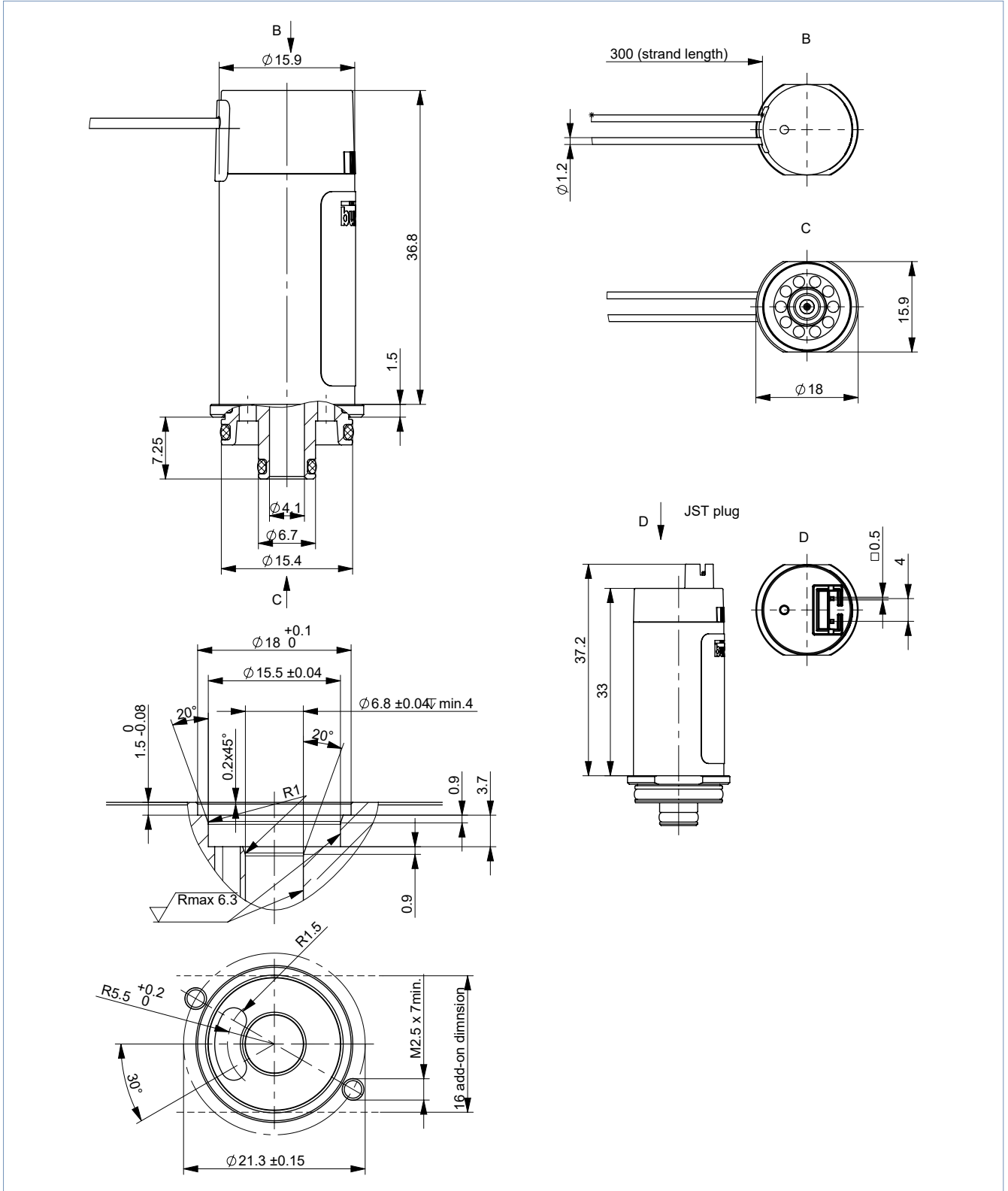

DTS 1000597991 EN Version: B Status: RL (released | freigegeben | validé) printed: 27.06.2024

6. Device/Process connections

6.1. Pin assignment flange version

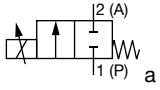
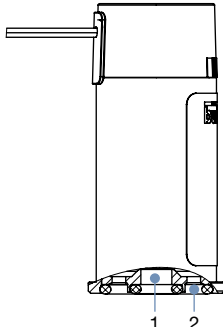
Circuit functions	Port 1	Port 2	2-way
CF A 2/2-way solenoid proportional control valve Direct-acting Normally closed 	Pressure port 1 (P)	Working port 2 (A)	

6.2. Pin assignment cartridge version

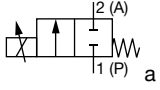
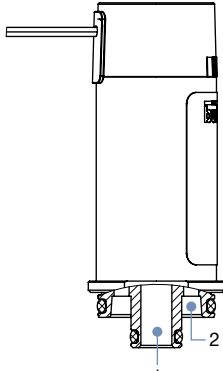
Circuit functions	Port 1	Port 2	2-way
CF A 2/2-way solenoid proportional control valve Direct-acting Normally closed 	Pressure port 1 (P)	Working port 2 (A)	

7. Performance specifications

7.1. Flow characteristic

Note:

The design of the nominal size of proportional valves is very important for the correct functioning within the application. The nominal size must be selected so that, on the one hand, the desired flow range is achieved and that, on the other hand, a sufficient part of the total pressure drop occurs via the valve when the valve is fully open. This means that the flow range in the controlled system is completely determined by the proportional valve.

The flow characteristics shown below have been recorded without back pressure and are purely exemplary. The flow characteristics may vary due to specific installation situations and operating conditions.

The valve Type 2852 is suitable for applications with back pressure. With a high inlet pressure in conjunction with a high back pressure, it should be noted that the flow characteristic curve has an increasingly high gradient in some areas and that discontinuities may occur. High thermal load combined with high inlet pressure may have an impact on the flow characteristic in the lower flow range. This can have a negative effect on the control behaviour.

For further information and support with the design, please contact your local Bürkert partner.

Flow characteristics as a function of the coil current

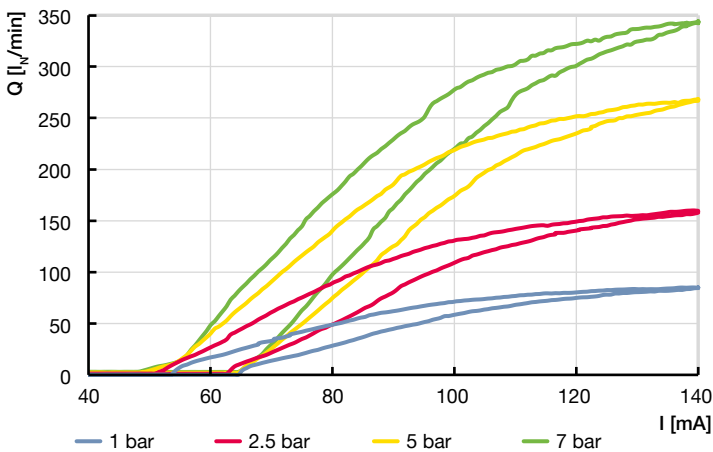

Maximum flow rate as a function of the operating pressure

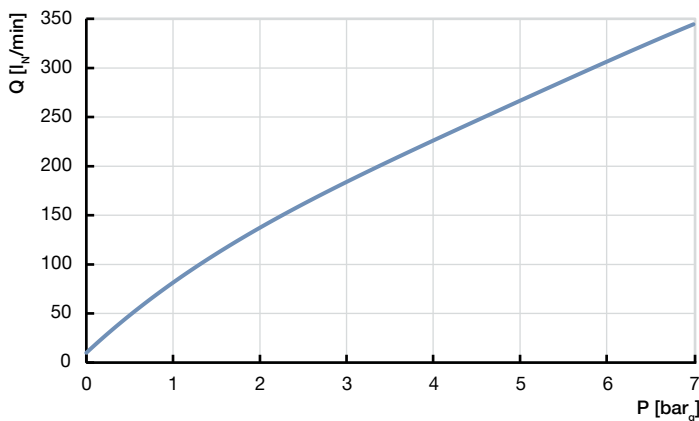

DTS 1000597991 EN Version: B Status: RL (released | freigegeben | validé) printed: 27.06.2024

Determination of the K_v value

Pressure drop	K_v value for liquids	K_v value for gases
	[m ³ /h]	[m ³ /h]
Sub-critical $p_2 > \frac{p_1}{2}$	$= Q \sqrt{\frac{\rho}{1000 \Delta p}}$	$= \frac{Q_N}{514} \sqrt{\frac{T_1 \rho_N}{p_2 \Delta p}}$
Supercritical $p_2 < \frac{p_1}{2}$	$= Q \sqrt{\frac{\rho}{1000 \Delta p}}$	$= \frac{Q_N}{257 p_1} \sqrt{T_1 \rho_N}$

- K_v Flow coefficient [m³/h]^{1,3}
- Q_N Standard flow rate [m³/h]^{2,3}
- p_1 Inlet pressure [bar]^{3,3}
- p_2 Outlet pressure [bar]^{3,3}
- Δp Differential pressure p_1, \dots, p_2 [bar]
- ρ Density [kg/m³]
- ρ_N Standard density [kg/m³]
- T_1 Medium temperature [(273+t)K]

- 1.) Measured for water, $\Delta p = 1$ bar, over the value
- 2.) At reference conditions 1.013 bar and 0 °C (273 K)
- 3.) Absolute pressure

8. Product operation

8.1. Control unit

Valve control takes place through a PWM signal (pulse-width modulation) or constant current control. The duty cycle of the PWM signal determines the coil current and hence the position of the plunger. The control signal has an influence on the hysteresis of the flow curve. Higher PWM frequencies lead to hysteresis reduction.

Observe the PWM frequency and the operating voltage which are specified in chapter “1. General technical data” on page 3.

The valve is suitable for 100 % continuous duty cycle, as long as a medium is flowing. However, the specified nominal voltage must not be exceeded. With a constantly high duty cycle and high ambient temperature at the same time, the achievable valve current is reduced since the valve heats up.

Please note the design comments for such a control valve in chapter “7.1. Flow characteristic” on page 8.

DTS 1000597991 EN Version: B Status: RL (released | freigegeben | validé) printed: 27.06.2024

9. Ordering information

9.1. Bürkert eShop



Bürkert eShop – Easy ordering and quick delivery

You want to find your desired Bürkert product or spare part quickly and order directly? Our online shop is available for you 24/7. Sign up and enjoy all the benefits.

[Order online now](#)

9.2. Recommendation regarding product selection

Note:

- Use the Product Enquiry Form (see “9.4. Bürkert Product Enquiry Form” on page 10) for information about the device layout and send it to us after completion.
- Please note the chapter “7.1. Flow characteristic” on page 8 on product selection.

9.3. Bürkert product filter



Bürkert product filter – Get quickly to the right product

You want to select products comfortably based on your technical requirements? Use the Bürkert product filter and find suitable articles for your application quickly and easily.

[Try out our product filter](#)

9.4. Bürkert Product Enquiry Form

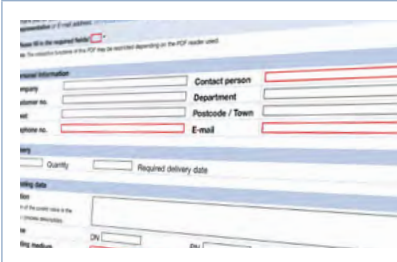

Bürkert Product Enquiry Form – Your enquiry quickly and compactly

Would you like to make a specific product enquiry based on your technical requirements? Use our Product Enquiry Form for this purpose. There you will find all the relevant information for your Bürkert contact. This will enable us to provide you with the best possible advice.

[Fill out the form now](#)



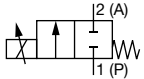

DTS 1000597991 EN Version: B Status: RL (released | freigegeben | validé) printed: 27.06.2024

9.5. Ordering chart

Standard version

Circuit function	Port connection	K _{vs} value	Nominal pressure	Electrical connection	Article no.	Article no.
		water ^{1.)}	[bar]		012/DC	024/DC
CF A 2/2-way solenoid proportional control valve Direct-acting Normally closed 	Flange (FK16)	0.2	7	300 mm flying leads	20072813	20072815
				JST connector	20076851	20076852
	Cartridge (FC18)	0.2	7	300 mm flying leads	20059148	20059147
				JST connector	20076847	20076850

1.) Measured with air, without back pressure

Further versions on request	
 Material Seal material EPDM	 Analytical Oxygen version, oil-, fat- and silicone-free parts
 Coil Version with plug contacts	 Approval Further information can be found in chapter “3. Approvals and conformities” on page 4.

9.6. Ordering chart accessories

Manifolds

Note:

Special custom-built manifolds are available on request.

Further accessories

Description	Article no.
Cable plug with 300 mm flying leads AWG 24	20081791
Terminal block G 1/8 for cartridge version (FC18), stainless steel	20081629
Terminal block G 1/8 for flange version (FK16), stainless steel	20081790
Flat headed screw M 2.5 x 6, TORX T8 - A2 for valve mounting on terminal block, 10 pieces	20057873