





Direct-acting 2-way Solenoid Control Valve

- For high flow rates
- Direct-acting, normally closed
- Operating pressure 0...25 bar
- Orifice sizes 3.0...12 mm
- Port connection 1/2" and 3/4"



Product variants described in the data sheet may differ from the product presentation and description.

Can be combined with

	Type 2518 Cable plug, form A according to DIN EN 175301-803	▶
	Type 8605 PWM control electronics for electromagnetic proportional valves	▶
	Type 8611 eCONTROL – Universal controller	▶

Type description

The direct-acting proportional valve Type 2836 works as an electromagnetically actuated control valve in applications with relatively highflow rates. The valve is normally closed.

DTS 1000023640 EN Version: R Status: RL (released | freigegeben | valide) printed: 22.01.2026

Table of contents

1. General technical data	3
2. Circuit functions	3
3. Approvals and conformities	4
3.1. General notes	4
3.2. Conformity	4
3.3. Standards	4
3.4. Others	4
Oxygen	4
4. Materials	4
4.1. Bürkert resistApp	4
5. Dimensions	5
6. Performance specifications	6
6.1. Flow characteristic	6
Determination of the K_v value.....	6
6.2. Exemplary characteristic curve of a proportional valve	6
7. Product operation	7
7.1. Control unit	7
8. Ordering information	7
8.1. Bürkert eShop	7
8.2. Recommendation regarding product selection.....	7
8.3. Bürkert product filter.....	7
8.4. Bürkert Product Enquiry Form	7
8.5. Ordering chart	8
8.6. Ordering chart accessories.....	8
Cable plug Type 2518, form A according to DIN EN 175301-803	8
Control electronics Type 8605 for proportional valves	9

1. General technical data

Product properties	
Dimensions	Further information can be found in chapter "5. Dimensions" on page 5.
Material	
Seal	FKM, EPDM
Body	Brass, stainless steel
Circuit function	A Further information can be found in chapter "2. Schaltungsfunktionen" on page 3.
Performance data	
Typical values of positioning behaviour ^{1.)}	
Hysteresis	< 5 %
Repeat accuracy	< 1 % FS ^{2.)}
Response sensitivity	< 0.5 % FS ^{2.)}
Setting range	1:25
Pressure range ^{3.)}	0...25 bar
Duty cycle	100 % continuous operation
Electrical data	
Operating voltage	24 V DC
Power consumption	24 W
Maximum coil current ^{4.)}	1100 mA
PWM frequency ^{5.)}	180 Hz
Medium data	
Operating medium	Neutral gases and liquids
Medium temperature	- 10 °C...+ 90 °C (with FKM) - 30 °C...+ 90 °C (with EPDM)
Viscosity	Max. 21 mm ² /s (21 cSt)
Product connections	
Electrical connection	Plug contacts according to DIN EN 175301 - 803 form A for cable plug Type 2518 ▶. Further information can be found in chapter "Cable plug Type 2518, form A according to DIN EN 175301 - 803" on page 8.
Port connection	G 1/2, G 3/4, NPT 1/2, NPT 3/4
Approvals and conformities	
Degree of protection	IP65
Environment and installation	
Installation position	As required, preferably with actuator upright
Ambient temperature	Max. + 55 °C (+ 131 °F)

- 1.) Characteristic data of control behaviour depends on process conditions.
- 2.) With flow measurement
- 3.) Pressure data: overpressure to atmospheric pressure, depending on nominal diameter, tightness seal or nominal pressure
- 4.) Maximum value: value depends on operating pressure
- 5.) PWM: pulse-width modulation

2. Circuit functions

Symbol	Description
	Circuit function A (CF A) 2/2-way solenoid proportional control valve Direct-acting Normally closed

DTS 1000023640 EN Version: R Status: RL (released | freigegeben | valide) printed: 22.01.2026

3. Approvals and conformities

3.1. General notes

- The approvals and conformities listed below must be stated when making enquiries. This is the only way to ensure that the product complies with all required specifications.
- Not all available variants can be supplied with the below mentioned approvals or conformities.

3.2. Conformity

In accordance with the Declaration of conformity, the product is compliant with the EU Directives.

3.3. Standards

The applied standards which are used to demonstrate compliance with the EU Directives are listed in the EU-Type Examination Certificate and/or the EU Declaration of Conformity.

3.4. Others

Oxygen

Conformity	Description
O ₂	Optional: Suitability for oxygen (valid for the variable code NL02) The products are suitable for use with gaseous oxygen, according to the manufacturer's declaration.

4. Materials

4.1. Bürkert resistApp

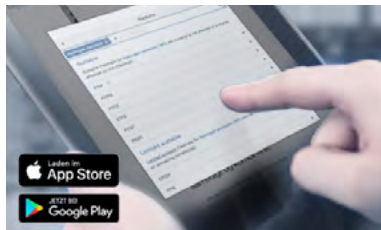

Bürkert resistApp – Chemical resistance chart

You want to ensure the reliability and durability of the materials in your individual application case? Verify your combination of media and materials on our website or in our resistApp.

[Start chemical resistance check](#)

DTS 1000023640 EN Version: R Status: RL (released | freigegeben | valide) printed: 22.01.2026

5. Dimensions

Note:

Dimensions in mm

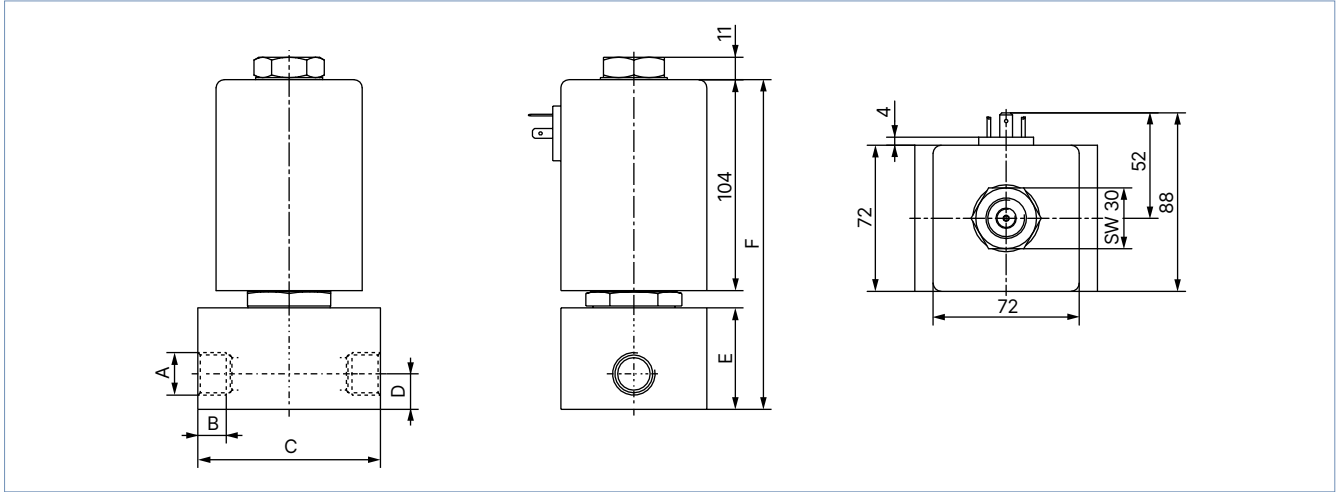

Port connection	A	B	C	D	E	F	Mass [g]
Thread	G 1/2, NPT 1/2	14	90	17.5	50	162.5	4000 (brass)
	G 3/4, NPT 3/4	16	90	17.5	50	162.5	4600 (stainless steel)

6. Performance specifications

6.1. Flow characteristic

Determination of the K_v value

Pressure drop	K_v value for liquids [m ³ /h]	K_v value for gases [m ³ /h]
Sub-critical $p_2 > \frac{p_1}{2}$	$= Q \sqrt{\frac{\rho}{1000 \Delta p}}$	$= \frac{Q_N}{514} \sqrt{\frac{T_1 \rho_N}{p_2 \Delta p}}$
Supercritical $p_2 < \frac{p_1}{2}$	$= Q \sqrt{\frac{\rho}{1000 \Delta p}}$	$= \frac{Q_N}{257 p_1} \sqrt{T_1 \rho_N}$

Value	Description	Unit
K_v	Flow coefficient	[m ³ /h] ^{1.)}
Q_N	Standard flow rate	[m ³ /h] ^{2.)}
p_1	Inlet pressure	[bar] ^{3.)}
p_2	Outlet pressure	[bar] ^{3.)}
Δp	Differential pressure $p_1 \dots p_2$	[bar]
ρ	Density	[kg/m ³]
ρ_N	Standard density	[kg/m ³]
T_1	Medium temperature	[(273+t)K]

1.) Measured for water, $\Delta p = 1$ bar, over the valve

2.) At reference conditions 1.013 bar and 0 °C (273 K)

3.) Absolute pressure

6.2. Exemplary characteristic curve of a proportional valve

Note:

The dimensioning of the nominal diameter is very important for proportional valves to function properly within the application. The nominal diameter must be selected so that, on the one hand, the desired flow range is achieved and, on the other hand, when the valve is fully open, a sufficient portion of the total pressure drop occurs across the valve.

Reference value: $\Delta p_{\text{valve}} > 25\%$ of the total pressure drop

Otherwise, an ideal, linear valve characteristic is deformed into a curved system characteristic.

If the differential pressure (difference between inlet and outlet pressure) exceeds half the value of the nominal pressure discontinuities may occur.

For that reason take advantage of Bürkert competent engineering services during the planning phase.

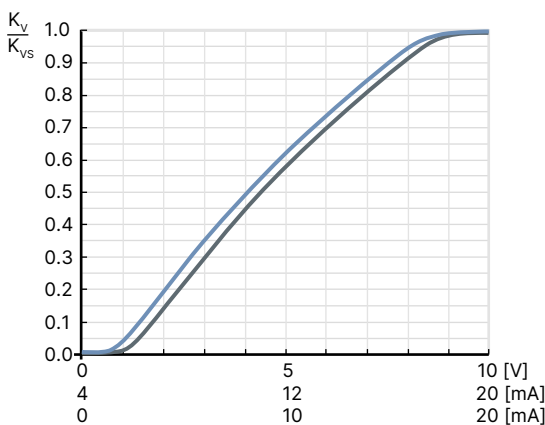

7. Product operation

7.1. Control unit

Valve control takes place through a PWM signal (pulse-width modulation). The duty cycle of the PWM signal determines the coil current and hence the position of the plunger.

The Bürkert control electronics Type 8605 (see data sheet **Type 8605** ▶) converts an analogue signal to a reference value corresponding to the valve type PWM signal and provides additional functions such as temperature compensation (coil heating), ramp function and the adjustment of minimum and maximum duty cycle/coil current for the control range.

Please note the sizing comments for such a control valve in chapter **“6.2. Exemplary characteristic curve of a proportional valve” on page 6**.

8. Ordering information

8.1. Bürkert eShop



Bürkert eShop – Easy ordering and quick delivery

You want to find your desired Bürkert product or spare part quickly and order directly? Our online shop is available for you 24/7. Sign up and enjoy all the benefits.

[Order online now](#)

8.2. Recommendation regarding product selection

Note:

- Use the product enquiry form (see **“8.4. Bürkert Product Enquiry Form” on page 7**) for information about the device layout and send it to us after completion.
- Please note the chapter **“6.2. Exemplary characteristic curve of a proportional valve” on page 6** on product selection.

8.3. Bürkert product filter



Bürkert product filter – Get quickly to the right product

You want to select products comfortably based on your technical requirements? Use the Bürkert product filter and find suitable articles for your application quickly and easily.

[Try out our product filter](#)

8.4. Bürkert Product Enquiry Form

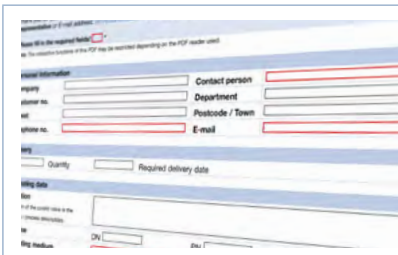

Bürkert Product Enquiry Form – Your enquiry quickly and compactly

Would you like to make a specific product enquiry based on your technical requirements? Use our Product Enquiry Form for this purpose. There you will find all the relevant information for your Bürkert contact. This will enable us to provide you with the best possible advice.

[Fill out the form now](#)

DTS 1000023640 EN Version: R Status: RL (released | freigegeben | valide) printed: 22.01.2026

8.5. Ordering chart

Note:

- All valves are delivered with FKM seals.
- Please note that the cable plug must be ordered separately, see **“Cable plug Type 2518, form A according to DIN EN 175301 - 803” on page 8** or separate data sheet for **Type 2518** ▶.

Circuit function	Port connection	Orifice	K _{vs} value water ^{1.)}	Nominal pressure ^{2.)}	Article no. brass body	Article no. stainless steel body
		[mm]	[m³/h]	[bar]		
CF A 2/2-way solenoid proportional control valve Direct-acting Normally closed 	G ½	3	0.25	25	154541 ☞	154542 ☞
	NPT ½		0.25	25	164592 ☞	–
	G ½	4	0.40	16	154543 ☞	154544 ☞
	NPT ½		0.40	16	164593 ☞	–
	G ½	6	0.90	8	145654 ☞	154545 ☞
	NPT ½		0.90	8	164594 ☞	–
	G ¾	8	0.90	8	154546 ☞	154547 ☞
	NPT ¾		0.90	8	164595 ☞	–
	G ½	8	1.5	5	154548 ☞	154549 ☞
	NPT ½		1.5	5	164596 ☞	–
	G ¾	10	1.5	5	154550 ☞	154551 ☞
	NPT ¾		1.5	5	164597 ☞	–
	G ¾	10	2.0	3	154552 ☞	154553 ☞
	NPT ¾		2.0	3	164598 ☞	–
	G ¾	12	2.5	2	154554 ☞	154555 ☞
NPT ¾	2.5		2	164599 ☞	–	

– = not available

1.) Measurement at + 20 °C, 1 bar pressure differential over a fully opened valve

2.) Pressure data: overpressure with respect to atmospheric pressure

8.6. Ordering chart accessories

Cable plug Type 2518, form A according to DIN EN 175301 - 803

Note:

- Dimensions in mm
- For further variants see data sheet **Type 2518** ▶.



Cable plug	Dimensions	Variant	Voltage	Article no.
		Without wiring (AC/DC)	0...250 V AC/DC	314802 ☞

DTS 1000023640 EN Version: R Status: RL (released | freigegeben | valide) printed: 22.01.2026

Control electronics Type 8605 for proportional valves

Note:

Refer to data sheet **Type 8605** ▶ for more information about the control electronics.

Control electronics	Variant	Max. coil current range	Voltage		Article no.
		[mA]	24 V DC	12 V DC	
	Cable plug with PG cable gland	500...2000	X	–	316529
	Cable plug with M12 connection	500...2000	X	–	316526
	Cable plug with PG cable gland without operating unit	500...2000	X	–	316523
	Cable plug with M12 connection without operating unit	500...2000	X	–	316525
	Standard rail	500...2000	X	–	316533

X = available
 – = not available

DTS 1000023640 EN Version: R Status: RL (released | freigegeben | valide) printed: 22.01.2026