



**Ball valve made of cast 316 stainless steel, 2-way, 3-piece**

- 1000/800 PSI WOG
- Thread, socket and butt weld ends
- Full port to Sch 40 pipe
- Semi lugged body
- Range of seal options
- Blow-out proof stem with self adjust packing
- ISO 5211 mounting flange

Product variants described in the data sheet may differ from the product presentation and description.

**Can be combined with**

	<b>Type 2051</b> Pneumatic rotary actuator	▶
	<b>Type 2053</b> Pneumatic rotary actuator for the automation of ball and butterfly valves	▶
	<b>Type 3003</b> Electrical Rotary Actuator - On/Off and control	▶
	<b>Type 3005</b> Electrical Rotary Actuator - On/Off and Control	▶
	<b>Type 3004</b> Explosion-Proof Rotary Actuator - On/Off or Control	▶
	<b>Type 1061</b> Position feedback unit for pneumatic rotary actuators	▶
	<b>Type 8692</b> Digital electropneumatic positioner for integrated mounting on process control valves	▶

**Type description**

This Burkert ball valve design is an industry proven three piece investment cast body with PTFE/FKM sealing. It finds wide use in fluid media while offering higher cycle life and reduced torque. The self-adjusting packing gland is a dual sealing type with an alignment collar for superior tightness.

The Type 2654 is automation ready with an ISO 5211 mounting pad for direct coupling of the actuator. A full range of actuators, pilots, digital positioners, feedback switches and bus network options are available for integration into plant control systems.

For maintenance, this design allows removal of all seals with just four bolts. The semi lugged body provides for easy re-assembly, without the debris pockets of enclosed bolt designs. The ball is full port style, presenting a CV and pressure drop similar to an open line, without restriction to high flow CIP or entrained solids.

## Table of contents

<b>1. General technical data</b>	<b>3</b>
<b>2. Control functions</b>	<b>3</b>
<b>3. Materials</b>	<b>4</b>
3.1. Bürkert resistApp .....	4
3.2. Material specifications .....	4
Standard valve .....	4
Standard valve, exploded view .....	5
<b>4. Dimensions</b>	<b>6</b>
4.1. 2051 ISO connection / star adapter .....	7
4.2. Reducing sleeve .....	8
<b>5. Performance specifications</b>	<b>9</b>
5.1. Pressure temperature diagram .....	9
<b>6. Product design and assembly</b>	<b>9</b>
6.1. Product features .....	9
V-ball for modulating controller .....	9
<b>7. Ordering information</b>	<b>9</b>
7.1. Bürkert eShop .....	9
7.2. Bürkert product filter .....	9
7.3. Ordering chart for manual ball valves .....	10
7.4. Ordering chart for 2051 pneumatic actuators .....	11
Double-acting actuator (control function I) torque ratings (in-lbs) .....	11
Spring-return actuator (control function A/B) .....	11
7.5. Ordering charts for electric actuators .....	12
3003 Multi-voltage actuator On/Off variant .....	12
3003 Multi-voltage actuator control variant, input and output signals (programmable 0...10 V, 4...20 ma and 0...20 ma) .....	12
3005 Multi-voltage actuator On/Off variant .....	13
3005 Multi-voltage actuator control variant, input and output signals (programmable 0...10 V, 4...20 ma and 0...20 ma) .....	13
3004 Ex actuator On/Off variant (ATEX II 2 GD Ex d II B T6) .....	13
3004 Ex actuator control variant (ATEX II 2 GD Ex d II B T6), input and output signals (programmable 0...10 V, 4...20 ma and 0...20 ma) .....	13
7.6. Ordering chart for accessories .....	14
Reducing sleeve .....	14
NAMUR pilot valve 6519 with 5/2-way and 3/2-way .....	14
Limit switch boxes .....	14
Ordering chart for screw sets suitable for interface according to ISO 5211 .....	14

## 1. General technical data

Product properties	
Dimensions	Further information can be found in chapter "4. Dimensions" on page 3.
Materials	
Seal	PTFE (ball seal, others to application)
Body	Stainless steel 1.4408/316 <sup>1)</sup>
Ball	Stainless steel 1.4401/316
Stem	Stainless steel 1.4401/316
Packing gland	Self-adjusting RPTFE, PTFE and FKM with stainless steel 304 guide/follower
Flow direction	Seals to rated pressure in both directions
Control functions	A, B and I Further information can be found in chapter "2. Control functions" on page 3.
Control option	Size to conditions or V port ball
Performance data	
Nominal pressure	1000 PSI: 1/4"...2" 800 PSI: 2 1/2"...4"
Medium data	
Medium temperature	- 20 °F...+ 375 °F (PTFE) + 450 °F (TFM)
Operating medium	Compatible with materials of construction and pressure / temperature limits of seals
Viscosity	As torque effect allows
Product connections	
Port connection	NPT 1/4"...NPT 4"
Port diameter class	Full port to Sch 40 pipe size
End connections	NPT: National pipe thread tapered Socket weld: to schedule pipe OD Butt weld: to schedule 40 pipe ID and OD
Environment and installation	
Installation	As required

1) Other valve body materials available to meet your specifications, contact your local Bürkert sales department for more information.

## 2. Control functions

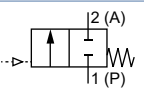
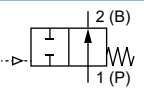
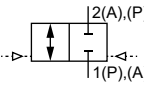
Symbol	Description
	<b>Control function A (CF A)</b> Pneumatically operated 2/2-way on/off valve Flow direction above seat Normally closed by spring force
	<b>Control function B (CF B)</b> Single-acting actuator for pneumatically operated 2/2-way on/off valve Normally ed by spring force
	<b>Control function I (CF I)</b> Pneumatically operated 2/2-way on/off valve on either side Bidirectional Switching position dependent on external control

### 3. Materials

#### 3.1. Bürkert resistApp

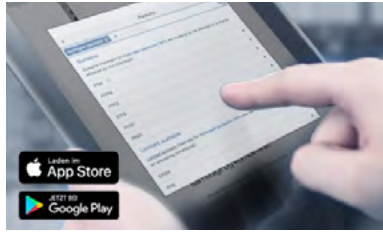

#### Bürkert resistApp – Chemical resistance chart

You want to ensure the reliability and durability of the materials in your individual application case? Verify your combination of media and materials on our website or in our resistApp.

[Start chemical resistance check](#)

#### 3.2. Material specifications

##### Standard valve

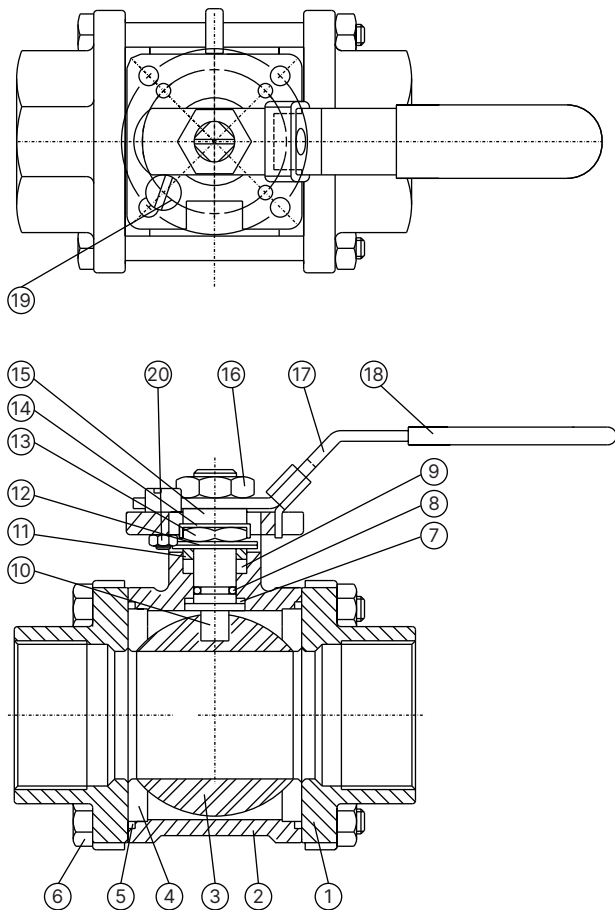

No.	Element	Material
1	End cap	Stainless steel 1.4408/316
2	Body	Stainless steel 1.4408/316
3	Ball	Stainless steel 1.4401/316
4	Seat	PTFE
5	Gasket	PTFE
6	Bolts	Stainless steel 1.4301/304
7	Thrust washer	RPTFE
8	O-ring	FKM
9	Stem packing	PTFE
10	Stem	Stainless steel 1.4401/316
11	Gland	Stainless steel 1.4301/304
12	Disk washer	Stainless steel 1.4310/301
13	Stem nut	Stainless steel 1.4301/304
14	Nut stop	Stainless steel 1.4301/304
15	Space washer	Stainless steel 1.4301/304
16	Handle nut	Stainless steel 1.4301/304
17	Handle	Stainless steel 1.4301/304
18	Sleeve	Plastic
19	Stop pin	Stainless steel 1.4301/304
20	Nut	Stainless steel 1.4301/304

DTS 1000152217 EN Version: F Status: RL (released | freigegeben | valide) printed: 30.03.2026

**Standard valve, exploded view**

**Note:**

See material chart on page "Standard valve" on page 4.

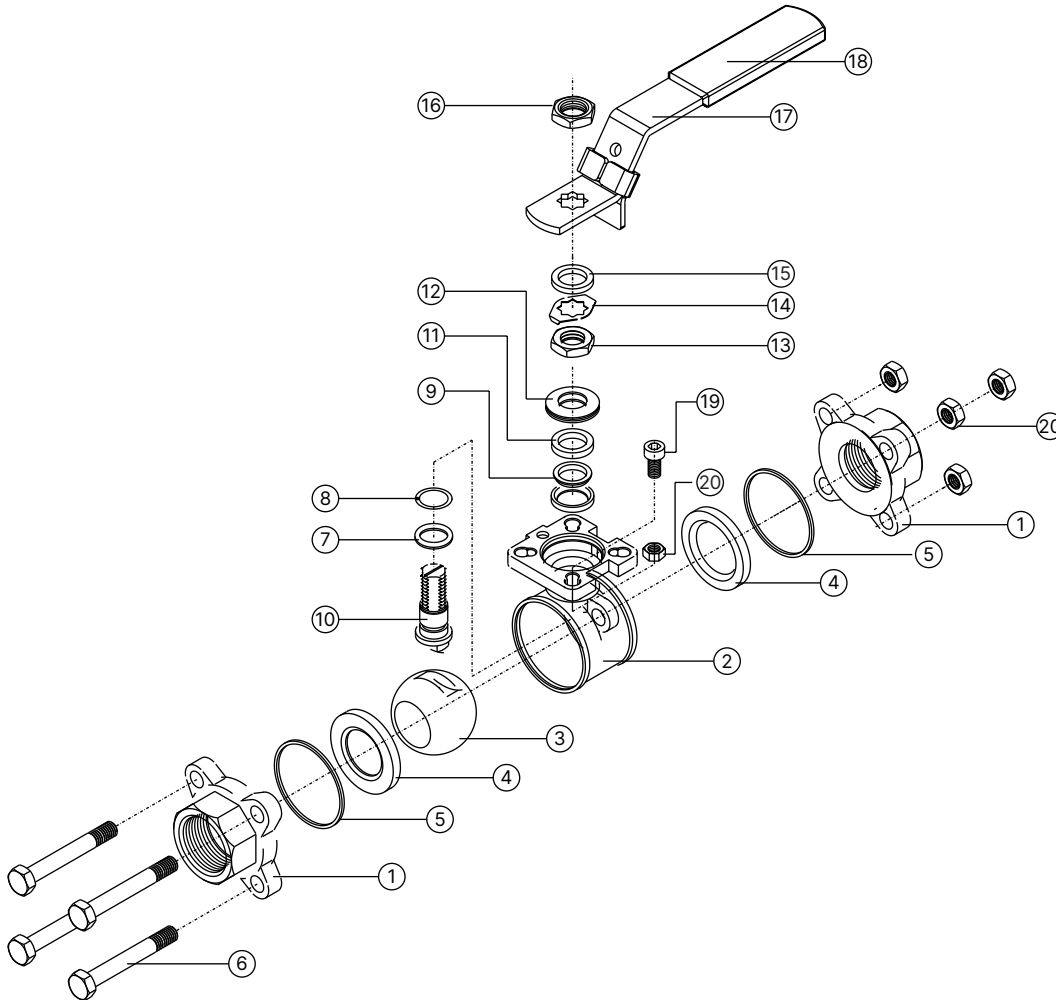

## 4. Dimensions

**Note:**

Dimensions in mm

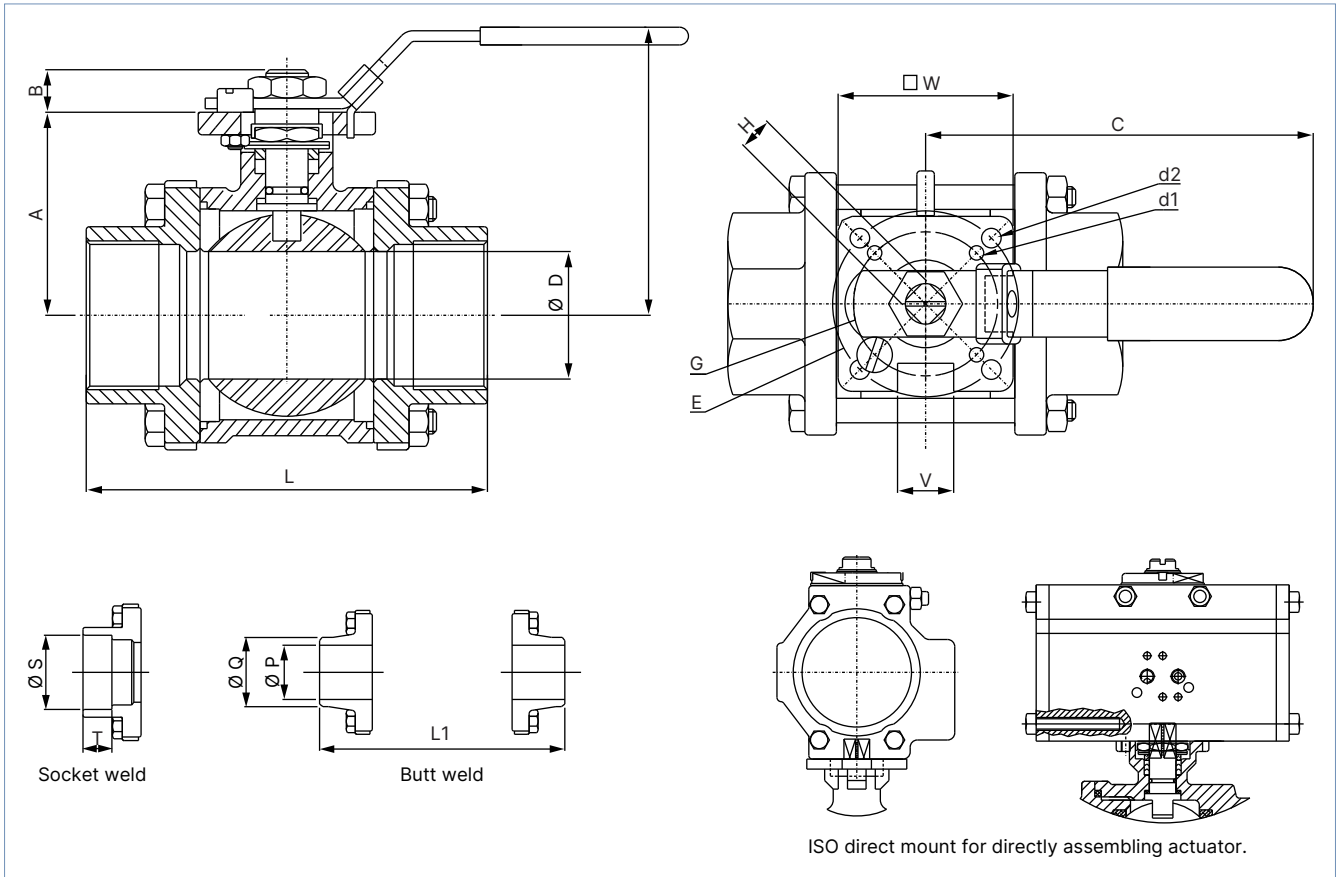

Size	A	B	C	D	d1	d2	E	F	G	H	L	S	T	P	Q	L1	V	W
1/4"	37	11	130	11	6	6	58	36	42	9	60.5	14.2	11.1	10	17	60.5	19	44
3/8"	37	11	130	12.5	6	6	58	36	42	9	60.5	17.5	11.1	12	19	60.5	19	44
1/2"	37	11	130	15	6	6	58	36	42	9	63.5	21.8	12.7	15	21.5	63.5	19	44
3/4"	40	11	130	20	6	6	64	36	45	9	75.5	27.1	14.3	20	27.5	75.5	19	44
1"	48	14	155	25	6	7	77	42	50	11	86	33.8	15.9	25	34.5	86	24	52
1 1/4"	53.5	14	155	32	6	7	83	42	50	11	96	42.5	17.5	32	42.8	104	24	52
1 1/2"	63.5	18	205	38	7	9	92	50	70	14	111	48.7	19.1	38	49	117	28	53
2"	72	18	205	50	7	9	100	50	70	14	129	61.1	22.2	50	61	138	28	53
2 1/2"	92	22	290	65	9	11.3	140	70	102	17	152.5	73.9	22.2	65	77	170	-	-
3"	102	22	290	80	9	11.3	150	70	102	17	168.5	89.9	25.4	80	91	192	-	-
4"	132	26	335	100	11.3	13.5	195	102	125	22	212.5	115.2	32	100	118	226	-	-

DTS 1000152217 EN Version: F Status: RL (released | freigegeben | valide) printed: 30.03.2026

**4.1. 2051 ISO connection / star adapter**

**Note:**

Dimensions in mm

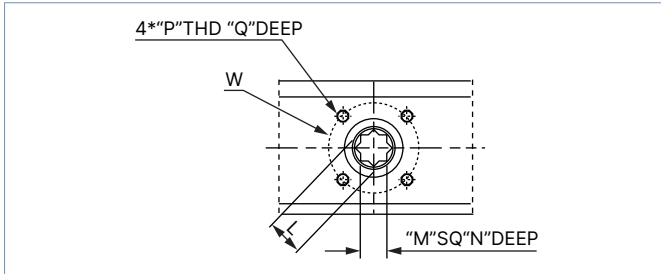

Actuator size	Interface acc. to ISO 5211	L	M	N	P	Q	W
125	F04	12.5	9	10	MxP0.8	8	42
250	F04 or F05	14.5	11	17	M5xP0.8/M6xP1.0	8.0/10.0	42.0/50.0
450	F05, F07	18.8	14	21	M6xP1.0/M8xP1.25	10.0/12.0	50.0/70.0
1000	F05, F07	23	17	25.5	M6xP1.0/M8xP1.25	10.0/12.0	50.0/70.0
2250	F07, F10	29.5	22	31	M8xP1.25/M10xP1.5	12.0/15.0	70.0/102.0
3650	F10, F12	35.5	27	35	M10xP1.5/M12xP1.75	15.0/19.0	102.0/125.0
5000	F10, F12	35.5	27	35	M10xP1.5/M12xP1.75	15.0/19.0	102.0/125.0
11000	F14	47.5	36	45	M16xP2.0	24	140

DTS 1000152217 EN Version: F Status: RL (released | freigegeben | valide) printed: 30.03.2026

### 4.2. Reducing sleeve

**Note:**

Dimensions in mm

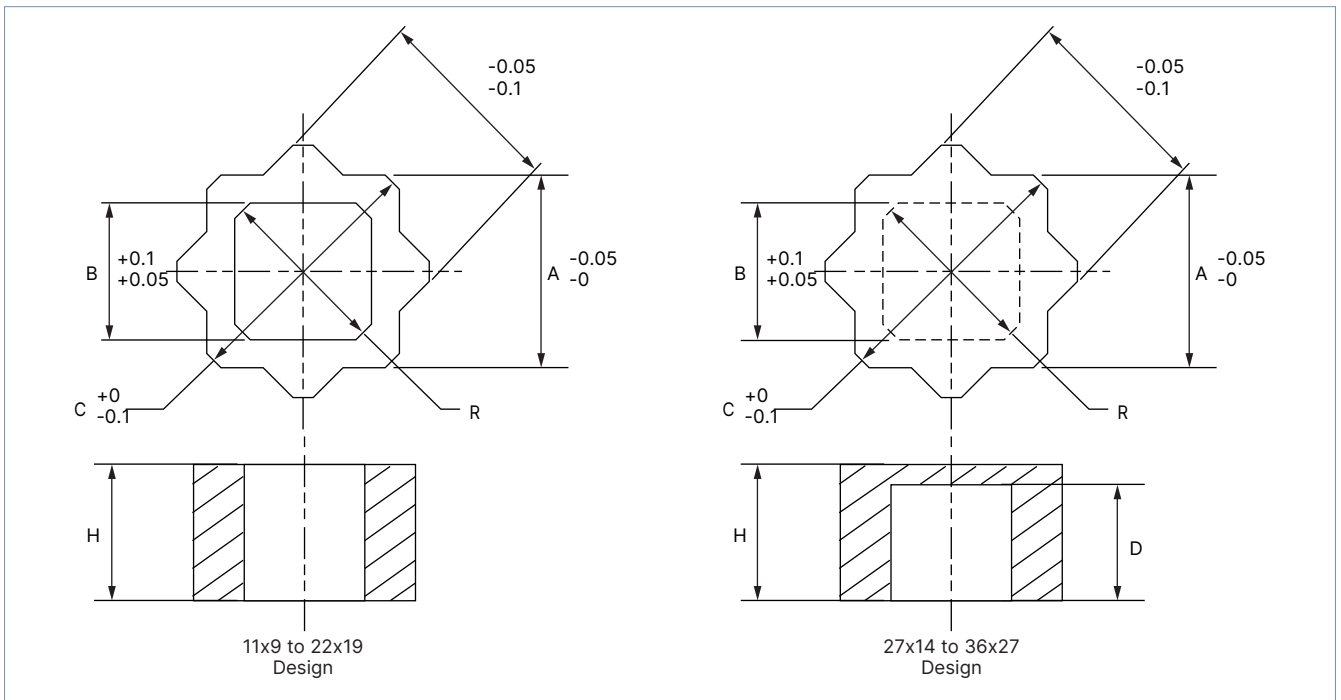
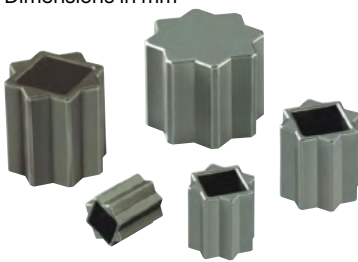

Insert	A	B	C	D	H	R	Article no.
11 × 9	11	9	15	–	17	12.5	98125211
14 × 9	14	9	19.1	–	20	12.5	665288
14 × 11	14	11	19.1	–	20	14.5	665289
17 × 9	17	9	23.1	–	24	12.5	98125212
17 × 11	17	11	23.1	–	24	14.5	98125213
17 × 14	17	14	23.1	–	24	19.2	665290
22 × 14	22	14	29.6	–	30	19.2	666684
22 × 17	22	17	29.6	–	30	23.3	666685
27 × 14	27	14	36	27	29	19.2	98125214
27 × 17	27	17	36	27	29	23.3	98125215
27 × 22	27	22	36	27	29	30	98125216
36 × 27	36	27	48	33	35	37	98125217

DTS 1000152217 EN Version: F Status: RL (released | freigegeben | valide) printed: 30.03.2026

## 5. Performance specifications

### 5.1. Pressure temperature diagram

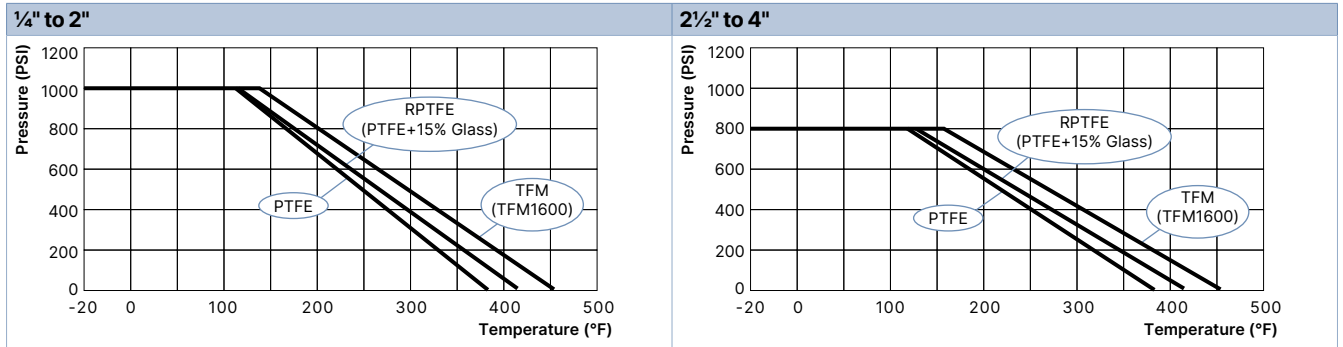

## 6. Product design and assembly

### 6.1. Product features

#### V-ball for modulating controller

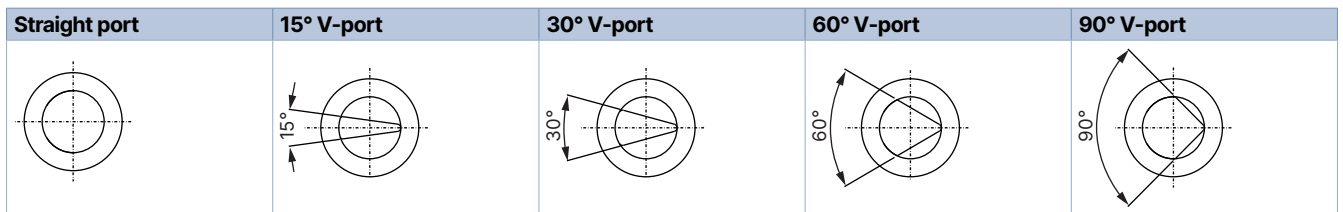

## 7. Ordering information

### 7.1. Bürkert eShop



**Bürkert eShop – Easy ordering and quick delivery**

You want to find your desired Bürkert product or spare part quickly and order directly? Our online shop is available for you 24/7. Sign up and enjoy all the benefits.

[Order online now](#)

### 7.2. Bürkert product filter

























**Bürkert product filter – Get quickly to the right product**











You want to select products comfortably based on your technical requirements? Use the Bürkert product filter and find suitable articles for your application quickly and easily.

[Try out our product filter](#)

## 7.3. Ordering chart for manual ball valves

Port connections	Orifice	C <sub>v</sub>	Seat material	WOG	Break torque value at 0 PSI		Interface acc. to ISO 5211	Article no.
					Lubed	Non-lubed		
NPT	[mm]	[gal/min]		[psi]	[Nm (in/lb)]	[Nm (in/lb)]		
1/4"	11	7.5	PTFE	1000	3.5 (31)	5.0 (44)	F03, F04	98124779 
3/8"	12.5	7.5	PTFE	1000	3.5 (31)	5.0 (44)	F03, F04	98124780 
1/2"	15	16	PTFE	1000	5.0 (44)	6.0 (53)	F03, F04	98124781 
3/4"	20	40	PTFE	1000	5.5 (49)	7.0 (62)	F03, F04	98124782 
1"	25	70	PTFE	1000	7.0 (62)	9.5 (84)	F04, F05	98124783 
1 1/4"	32	110	PTFE	1000	11.0 (97)	16.0 (142)	F04, F05	98124784 
1 1/2"	38	240	PTFE	1000	17.0 (150)	27.0 (239)	F05, F07	98124786 
2"	50	400	PTFE	1000	23.0 (204)	30.0 (266)	F05, F07	98124787 
2 1/2"	65	700	PTFE	800	35.0 (310)	68.0 (602)	F07, F10	98124788 
3"	80	980	PTFE	800	46.0 (407)	85.0 (752)	F07, F10	98124789 
4"	100	1700	PTFE	800	72.0 (637)	105.0 (929)	F10, F12	98124790 

Sch 40 butt weld connections	Orifice	C <sub>v</sub>	Seat material	WOG	Break torque value at 0 PSI		Interface acc. to ISO 5211	Article no.
					Lubed	Non-lubed		
	[mm]	[gal/min]		[psi]	[Nm (in/lb)]	[Nm (in/lb)]		
1/4"	11	7.5	PTFE	1000	3.5 (31)	5.0 (44)	F03, F04	98125116 
3/8"	12.5	7.5	PTFE	1000	3.5 (31)	5.0 (44)	F03, F04	98125117 
1/2"	15	16	PTFE	1000	5.0 (44)	6.0 (53)	F03, F04	98125118 
3/4"	20	40	PTFE	1000	5.5 (49)	7.0 (62)	F03, F04	98125119 
1"	25	70	PTFE	1000	7.0 (62)	9.5 (84)	F04, F05	98125120 
1 1/4"	32	110	PTFE	1000	11.0 (97)	16.0 (142)	F04, F05	98125121 
1 1/2"	38	240	PTFE	1000	17.0 (150)	27.0 (239)	F05, F07	98125122 
2"	50	400	PTFE	1000	23.0 (204)	30.0 (266)	F05, F07	98125123 
2 1/2"	65	700	PTFE	800	35.0 (310)	68.0 (602)	F07, F10	98125124 
3"	80	980	PTFE	800	46.0 (407)	85.0 (752)	F07, F10	98125125 
4"	100	1700	PTFE	800	72.0 (637)	105.0 (929)	F10, F12	98125127 

Sch 40 butt weld connections	Orifice	C <sub>v</sub>	Seat material	WOG	Break torque value at 0 PSI		Interface acc. to ISO 5211	Article no.
					Lubed	Non-lubed		
	[mm]	[gal/min]		[psi]	[Nm (in/lb)]	[Nm (in/lb)]		
1/4"	11	7.5	PTFE	1000	3.5 (31)	5.0 (44)	F03, F04	98125126 
3/8"	12.5	7.5	PTFE	1000	3.5 (31)	5.0 (44)	F03, F04	98125128 
1/2"	15	16	PTFE	1000	5.0 (44)	6.0 (53)	F03, F04	98125129 
3/4"	20	40	PTFE	1000	5.5 (49)	7.0 (62)	F03, F04	98125130 
1"	25	70	PTFE	1000	7.0 (62)	9.5 (84)	F04, F05	98125131 
1 1/4"	32	110	PTFE	1000	11.0 (97)	16.0 (142)	F04, F05	98125132 
1 1/2"	38	240	PTFE	1000	17.0 (150)	27.0 (239)	F05, F07	98125133 
2"	50	400	PTFE	1000	23.0 (204)	30.0 (266)	F05, F07	98125134 
2 1/2"	65	700	PTFE	800	35.0 (310)	68.0 (602)	F07, F10	98125135 
3"	80	980	PTFE	800	46.0 (407)	85.0 (752)	F07, F10	98125136 
4"	100	1700	PTFE	800	72.0 (637)	105.0 (929)	F10, F12	98125137 

### 7.4. Ordering chart for 2051 pneumatic actuators

**Note:**

When selecting an actuator we suggest a 20 % to 40 % above the break torque of the valve (subject to the valve and operating conditions). For other specifications, dimensions, and electrical connections see specific datasheets.

**Double-acting actuator (control function I) torque ratings (in-lbs)**

Actuator size	Air torque output at operating pressure [Psig]					Article no.
	40	60	80	100	120	
125	63	94	125	156	188	98124996
250	125	187	250	312	375	98124997
450	225	337	450	562	675	98124998
1000	500	750	1000	1250	1500	98124999
2250	1125	1687	2250	2812	3375	98125000
3650	1825	2738	3650	4563	5475	98125001
5000	2500	3750	5000	6250	7500	98125002
11000	5500	8250	11000	13750	16500	98125003

**Spring-return actuator (control function A/B)**

Actuator size	Spring set	Spring torque		Air torque output at operating pressure [Psig]								Article no.
				60		80		100		120		
		Start	End	Start	End	Start	End	Start	End	Start	End	
125	R3	104	67	113	70	176	133	229	195	301	258	98124976
	R4	140	90	88	31	151	93	213	156	276	218	98124977
450	R3	190	121	203	125	316	238	428	350	541	463	98124978
	R4	254	162	158	54	271	167	383	279	496	392	98124979
1000	R3	418	270	449	278	698	526	947	775	1196	1025	98124980
	R4	559	360	350	120	599	371	848	618	1097	867	98124981
2250	R3	990	590	1034	591	1596	1154	2159	1717	2722	2280	98124984
	R4	1320	787	816	226	1379	788	2029	1351	2505	1914	98124986
3650	R3	1573	912	1726	996	2637	1907	3549	2819	4460	3730	98124988
	R4	2091	1217	1388	423	2300	1335	3211	2246	4123	3157	98124989
5000	R3	2340	1180	2380	1200	3570	2400	4760	3590	5960	4780	98124990
	R4	3130	1570	1980	414	3180	1600	4370	2800	5560	3990	98124991
11000	R3	5100	2570	5200	2650	7790	5240	10400	7840	13000	10400	98124992
	R4	6790	3430	4330	932	6930	3530	9520	6130	12100	8730	98124993









DTS 1000152217 EN Version: F Status: RL (released | freigegeben | valide) printed: 30.03.2026

## 7.5. Ordering charts for electric actuators

### Note:









When selecting the on/off variant, we recommend a safety torque equal to 1.5 times the max break torque of the valve, and for the control variant we recommend a safety torque equal to 2 times the max break torque of the valve. For other specifications, dimensions, and electrical connections see specific datasheets.

### 3003 Multi-voltage actuator On/Off variant

Drive stars	Reducing sleeve included	Interface acc. to ISO 5211	Torque	90° rotation time ± 1 s	Power consumption	Voltage / frequency	Article no.
[mm]	[mm]		[Nm]	[s]	[W]		
14	14/11, 14/9	F05 (F03, F04)	20	12	15	15...30 V AC, 50/60 Hz / 12...24 V DC <sup>1)</sup>	225192 
14	14/11, 14/9	F05 (F03, F04)	20	12	15	100...240 V AC, 50/60 Hz / 100...350 V DC	225193 
22	22/14	F05-F07	35	7	45	15...30 V AC, 50/60 Hz / 12...24 V DC <sup>1)</sup>	225194 
22	22/14	F05-F07	35	7	45	100...240 V AC, 50/60 Hz / 100...350 V DC	225195 
22	22/14	F05-F07	60	12	45	15...30 V AC, 50/60 Hz / 12...24 V DC <sup>1)</sup>	225196 
22	22/14	F05-F07	60	12	45	100...240 V AC, 50/60 Hz / 100...350 V DC	225197 
22	22/17	F05-F07	100	23	45	15...30 V AC, 50/60 Hz / 12...24 V DC <sup>1)</sup>	225198 
22	22/17	F05-F07	100	23	45	100...240 V AC, 50/60 Hz / 100...350 V DC	225225 





1.) The operating voltage must not fall below 11.5 V

### 3003 Multi-voltage actuator control variant, input and output signals (programmable 0...10 V, 4...20 ma and 0...20 ma)





Drive stars	Reducing sleeve included	Interface acc. to ISO 5211	Torque	90° rotation time ± 1 s	Power consumption	Voltage / frequency	Article no.
[mm]	[mm]		[Nm]	[s]	[W]		
14	14/11, 14/9	F05 (F03, F04)	20	25	15	15...30 V AC, 50/60 Hz / 12...24 V DC <sup>1)</sup>	225199 
14	14/11, 14/9	F05 (F03, F04)	20	25	15	100...240 V AC, 50/60 Hz / 100...350 V DC	225200 
22	22/14	F05-F07	35	40	45	15...30 V AC, 50/60 Hz / 12...24 V DC <sup>1)</sup>	225201 
22	22/14	F05-F07	35	40	45	100...240 V AC, 50/60 Hz / 100...350 V DC	225202 
22	22/14	F05-F07	60	79	45	15...30 V AC, 50/60 Hz / 12...24 V DC <sup>1)</sup>	225203 
22	22/14	F05-F07	60	79	45	100...240 V AC, 50/60 Hz / 100...350 V DC	225204 
22	22/17	F05-F07	100	119	45	15...30 V AC, 50/60 Hz / 12...24 V DC <sup>1)</sup>	225205 
22	22/17	F05-F07	100	119	45	100...240 V AC, 50/60 Hz / 100...350VDC	225206 

1.) The operating voltage must not fall below 11.5 V













## 3005 Multi-voltage actuator On/Off variant

Drive stars	Reducing sleeve included	Interface acc. to ISO 5211	Torque	90° rotation time ± 1 s	Power consumption	Voltage / frequency	Article no.
[mm]	[mm]		[Nm]	[s]	[W]		
22	22/17	F07-F10	150	30	45	100...240 V AC, 50/60 Hz	181303 
22	22/17	F07-F10	150	30	45	24 V AC/DC	181304 
22	22/17	F07-F10	300	50	85	100...240 V AC, 50/60 Hz	181305 
22	22/17	F07-F10	300	50	85	24 V AC/DC	181306 













## 3005 Multi-voltage actuator control variant, input and output signals (programmable 0...10 V, 4...20 ma and 0...20 ma)

Drive stars	Reducing sleeve included	Interface acc. to ISO 5211	Torque	90° rotation time ± 1 s	Power consumption	Voltage / frequency	Article no.
[mm]	[mm]		[Nm]	[s]	[W]		
22	22/17	F07-F10	150	30	45	100...240 V AC, 50/60 Hz	181293 
22	22/17	F07-F10	150	30	45	24 V AC/DC	179725 
22	22/17	F07-F10	300	50	85	100...240 V AC, 50/60 Hz	181307 
22	22/17	F07-F10	300	50	85	24 V AC/DC	179726 

## 3004 Ex actuator On/Off variant (ATEX II 2 GD Ex d II B T6)

Drive stars	Reducing sleeve included	Interface acc. to ISO 5211	Torque	90° rotation time ± 1 s	Power consumption	Voltage / frequency	Article no.
[mm]	[mm]		[Nm]	[s]	[W]		
17	17/11	F05-F07	25	7	45	100...240 V AC, 50/60 Hz	181308 
17	17/11	F05-F07	25	7	45	24 V AC/DC	181309 
17	17/14	F05-F07	45	15	45	100...240 V AC, 50/60 Hz	181310 
17	17/14	F05-F07	45	15	45	24 V AC/DC	181311 
17	17/14	F05-F07	75	20	45	100...240 V AC, 50/60 Hz	181312 
17	17/14	F05-F07	75	20	45	24 V AC/DC	181313 
22	22/17	F07-F10	100	15	45	100...240 V AC, 50/60 Hz	181314 
22	22/17	F07-F10	100	15	45	24 V AC/DC	181315 
22	22/17	F07-F10	150	30	45	100...240 V AC, 50/60 Hz	181316 
22	22/17	F07-F10	150	30	45	24 V AC/DC	181317 
22	22/17	F07-F10	300	50	85	100...240 V AC, 50/60 Hz	181318 
22	22/17	F07-F10	300	50	85	24 V AC/DC	181319 

## 3004 Ex actuator control variant (ATEX II 2 GD Ex d II B T6), input and output signals (programmable 0...10 V, 4...20 ma and 0...20 ma)

Drive stars	Reducing sleeve included	Interface acc. to ISO 5211	Torque	90° rotation time ± 1 s	Power consumption	Voltage / frequency	Article no.
[mm]	[mm]		[Nm]	[s]	[W]		
17	17/11	F05-F07	25	15	45	100...240 V AC, 50/60 Hz	182324 
17	17/11	F05-F07	25	15	45	24 V AC/DC	182326 
17	17/14	F05-F07	45	15	45	100...240 V AC, 50/60 Hz	182327 
17	17/14	F05-F07	45	15	45	24 V AC/DC	182330 
17	17/14	F05-F07	75	20	45	100...240 V AC, 50/60 Hz	182335 
17	17/14	F05-F07	75	20	45	24 V AC/DC	182384 
22	22/17	F07-F10	100	15	45	100...240 V AC, 50/60 Hz	182385 
22	22/17	F07-F10	100	15	45	24 V AC/DC	182386 
22	22/17	F07-F10	150	30	45	100...240 V AC, 50/60 Hz	182388 
22	22/17	F07-F10	150	30	45	24 V AC/DC	182390 
22	22/17	F07-F10	300	50	85	100...240 V AC, 50/60 Hz	182392 
22	22/17	F07-F10	300	50	85	24 V AC/DC	182394 

## 7.6. Ordering chart for accessories

### Reducing sleeve









**Note:**

Further ordering information can be found in chapter "4.2. Reducing sleeve" on page 8.



### NAMUR pilot valve 6519 with 5/2-way and 3/2-way

**Note:**





For other specifications, dimensions and electrical connections see specific datasheets.

Circuit function	Orifice [mm]	Q <sub>Nn</sub> valve air [l/min]	C <sub>v</sub> [gal/min]	Seal material	Socket connection material	Voltage /frequency	Article no.
CF W	6.0	900	1.3	NBR, PUR	Nickel-plated brass	24 V DC, 2 W	132727 
						24 V 60 Hz, 2 W	420843 
						120 V 60 Hz, 2 W	420844 
						240 V 60 Hz, 2 W	420845 
CF W	6.0	900	1.3	NBR, PUR	Stainless Steel	24 V DC, 2 W	458411 
						24 V 60 Hz, 2 W	458410 
						120 V 60 Hz, 2 W	458412 
						240 V 60 Hz, 2 W	458413 

### Limit switch boxes

Type	Ambient temperature	Protection class	Position feedback	Position indicator	Cable entry	Article no.
APL-210 N	- 4 °F...+ 176 °F (- 20 °C...+ 80 °C)	IP67/NEMA 4 and 4X	2 SPDT Mechanical	Closed (red), Open (yellow)	2 x 1/2" NPT	98125280 
E-07	- 4 °F...+ 185 °F (- 20 °C...+ 85 °C)	Ex d IIC T6	2 SPDT Mechanical	Closed (red), Open (yellow)	2 x 3/4" NPT	98125281 
APL-510 N	- 4 °F...+ 140 °F (- 20 °C...+ 60 °C)	IP67/NEMA 4, 4X, 7, 9 E Ex d IIC T6	2 SPDT Mechanical	Closed (red), Open (yellow)	2 x 3/4" NPT	98125282 

### Ordering chart for screw sets suitable for interface according to ISO 5211

Interface acc. to ISO 5211	4 x socket set screw DIN 916 A2 S/S 18 - 8	Includes 4 x flat washer DIN 125 A4 S/S 18 - 8	4 x metric hex nut DIN 934 A2 S/S 18 - 8	Article no.
	[mm]	[mm]	[mm]	
F04	M5 - 0.8 × 25	M5 - 5.3 × 10	M5 - 0.8 × 8 × 4	98125298 
F05	M6 - 1 × 25	M6 - 6.4 × 12	M6 - 1 × 10 × 5	98125299 
F07	M8 - 1.25 × 25	M8 - 8.4 × 16	M8 - 1.25 × 13 × 6.5	98125300 
F10	M10 - 1.5 × 35	M10 - 10.5 × 20	M10 - 1.5 × 17 × 8	98125301 
F12	M12 - 1.75 × 40	M12 - 13 × 24	M12 - 1.75 × 19 × 10	98125302 
F14	M16 - 2 × 40	M16 - 17 × 28	M16 - 2 × 24 × 13	98125303 