

**2651
standard**



Ball Valves in cast 316 SS 2-way, screwed body

- 1000 PSI WOG
- Thread ends
- Full port to Sch 40 pipe
- Compact body size
- PTFE seals
- Blow-out proof stem with self adjust packing
- ISO 5211 direct actuator mounts

Type 2651 can be combined with...



Stem Extensions

Fugitive emissions bonnet

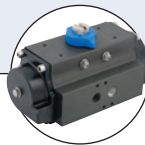

Type 2051

Pneumatic rotary actuator



Type 3003

Electric rotary actuator



Type 3004

Electric explosion proof actuator



Type 3005

Electric rotary actuator



Type 8792

Positioner

This Burkert ball valve design is an industry proven two piece investment cast body with PTFE/FKM sealing. It finds wide use in fluid media while offering higher cycle life and reduced torque. The self-adjusting packing gland is a dual sealing type with an alignment collar for superior tightness.

The Type 2651 is automation ready with an ISO 5211 mounting pad for direct coupling of the actuator. A full range of actuators, pilots, digital positioners, feedback switches and bus network options are available for integration into plant control systems.

For maintenance, this design allows removal of all seals through one end port. The screwed body provides for easy re-assembly, without the debris pockets of enclosed bolt designs. The ball is full port style, presenting a C_v and pressure drop similar to an open line, without restriction to high flow CIP or entrained solids.

Technical data	
Valve size	1/4" to 1"
Body materials¹⁾	CF8M (cast 316 SS)
Ball material	316 SS
Stem material	316 SS
Port diameter class	Full port to Sch 40 pipe size
Ball seal material	PTFE (others to application)
Media	Compatible with materials of construction and pressure / temperature limits of seals
Viscosity	As torque effect allows
Packing gland	Self-adjusting RPTFE, PTFE and FKM with 304SS guide/follower
Media temperature	-20°F to 375°F (PTFE)
End connections	NPT – National pipe thread tapered
Installation	As required
Flow direction	Seals to rated pressure in both directions
Control option	Size to conditions
Pressure rating	1000 PSI - 1/4" to 1"

¹⁾ Other valve body materials available to meet your specifications, contact your local Burkert representative for more information.

Ordering chart for manual ball valves

NPT port connections	Orifice [mm]	C _v	Seat	WOG [PSI]	Break torque value NM (in/lb) at 0 PSI		5211 ISO mounting pad	item no.
					Lubed	Non-lubed		
1/4"	10.0	7.5	PTFE	1000	3.5 (31)	5.0 (44)	F03 & F04	98124773
3/8"	12.5	7.5	PTFE	1000	3.5 (31)	5.0 (44)	F03 & F04	98124774
1/2"	15.0	16.0	PTFE	1000	5.0 (44)	6.0 (53)	F03 & F04	98124776
3/4"	20.0	40.0	PTFE	1000	5.5 (49)	7.0 (62)	F03 & F04	98124777
1"	25.0	70.0	PTFE	1000	7.0 (62)	9.5 (84)	F04 & F05	98124778

Pressure-temperature limits

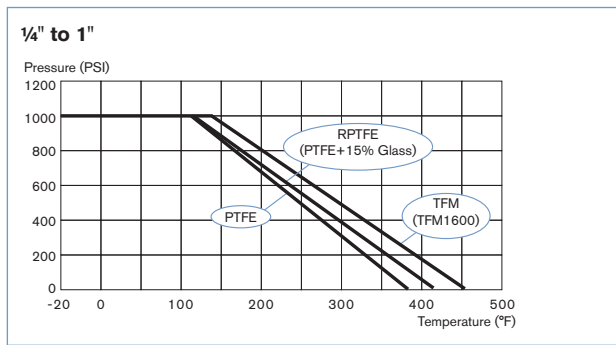

Dimensions [mm]

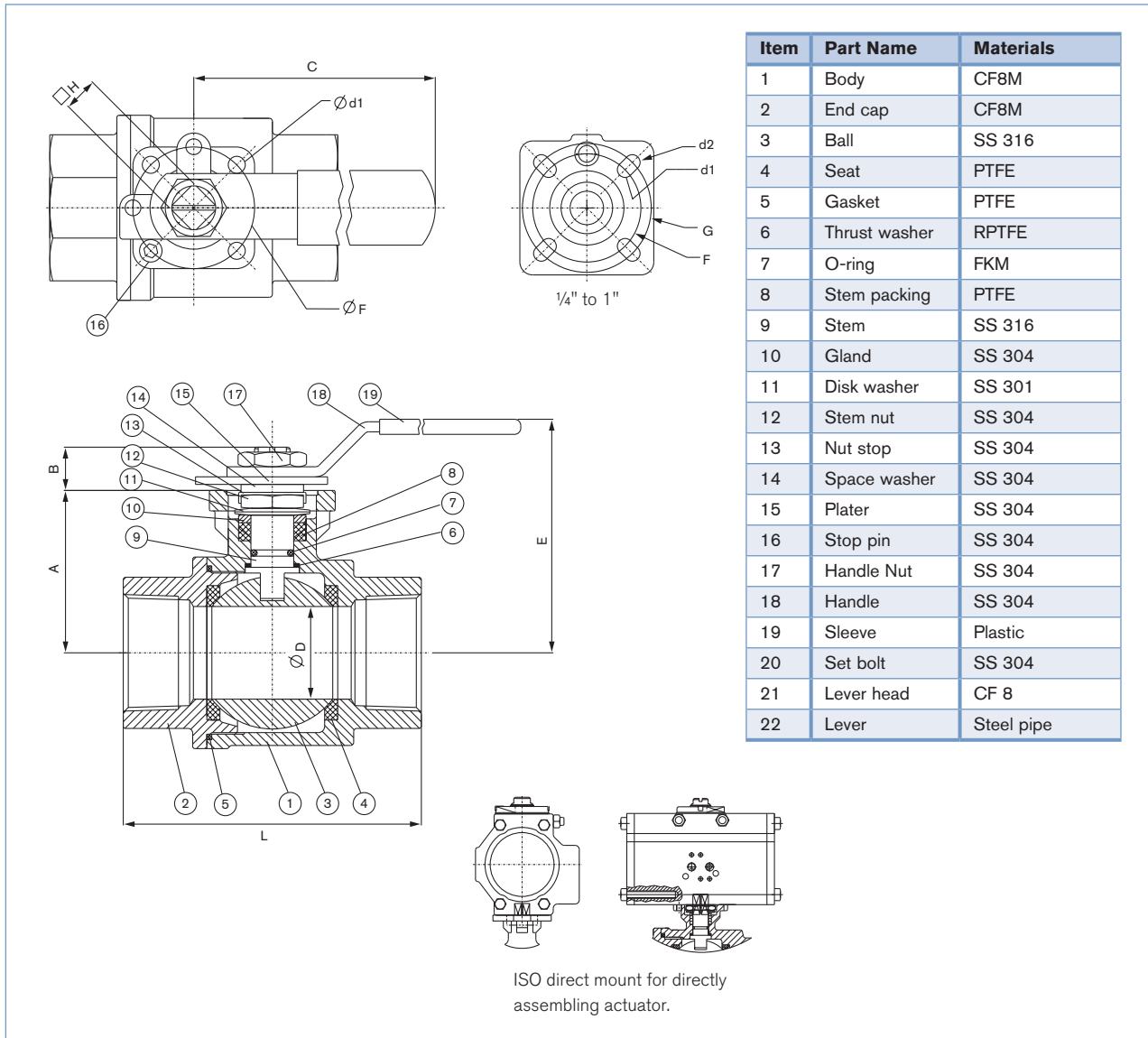

Size	A	B	C	D	d1	d2	E	F	G	H	L
1/4"	37	9	130	11	6.0	6.0	66	36	42	9	56.5
3/8"	37	9	130	12.5	6.0	6.0	66	36	42	9	56.5
1/2"	37	9	130	15	6.0	6.0	66	36	42	9	59.0
3/4"	40	11	130	20	6.0	6.0	69	36	42	9	72.0
1"	48	14	160	25	6.0	7.0	80	42	50	11	79.5

Ordering chart for 2051 pneumatic actuators

Note: When selecting an actuator we suggest a 20% to 40% above the break torque of the valve (subject to the valve and operating conditions). For other specifications, dimensions, and electrical connections see specific datasheets.

Double-acting actuator (Control function I) torque ratings (in-lbs)

Actuator size	Air torque output at operating pressure - Psig					Item no.
	40	60	80	100	120	
125	63	94	125	156	188	98124996
250	125	187	250	312	375	98124997
450	225	337	450	562	675	98124998
1000	500	750	1000	1250	1500	98124999
2250	1125	1687	2250	2812	3375	98125000
3650	1825	2738	3650	4563	5475	98125001
5000	2500	3750	5000	6250	7500	98125002
11000	5500	8250	11000	13750	16500	98125003

Spring-return actuator (Control function A/B)

Actuator size	Spring set	Spring torque		Air torque output at operating pressure - Psig								Item no.
				60		80		100		120		
		Start	End	Start	End	Start	End	Start	End	Start	End	
125	R3	104	67	113	70	176	133	229	195	301	258	98124976
	R4	140	90	88	31	151	93	213	156	276	218	98124977
450	R3	190	121	203	125	316	238	428	350	541	463	98124978
	R4	254	162	158	54	271	167	383	279	496	392	98124979
1000	R3	418	270	449	278	698	526	947	775	1196	1025	98124980
	R4	559	360	350	120	599	371	848	618	1097	867	98124981
2250	R3	990	590	1034	591	1596	1154	2159	1717	2722	2280	98124984
	R4	1320	787	816	226	1379	788	2029	1351	2505	1914	98124986
3650	R3	1573	912	1726	996	2637	1907	3549	2819	4460	3730	98124988
	R4	2091	1217	1388	423	2300	1335	3211	2246	4123	3157	98124989
5000	R3	2340	1180	2380	1200	3570	2400	4760	3590	5960	4780	98124990
	R4	3130	1570	1980	414	3180	1600	4370	2800	5560	3990	98124991
11000	R3	5100	2570	5200	2650	7790	5240	10400	7840	13000	10400	98124992
	R4	6790	3430	4330	932	6930	3530	9520	6130	12100	8730	98124993

2051 ISO connection / Star adapter dimensions [mm]

Actuator size	ISO pattern	L	M	N	P	Q	W
125	F04	12.5	9.0	10.0	MxP0.8	8.0	42.0
250	F04 or F05	14.5	11.0	17.0	M5xP0.8/M6xP1.0	8.0/10.0	42.0/50.0
450	F05 & F07	18.8	14.0	21.0	M6xP1.0/M8xP1.25	10.0/12.0	50.0/70.0
1000	F05 & F07	23.0	17.0	25.5	M6xP1.0/M8xP1.25	10.0/12.0	50.0/70.0
2250	F07 & F10	29.5	22.0	31.0	M8xP1.25/M10xP1.5	12.0/15.0	70.0/102.0
3650	F10 & F12	35.5	27.0	35.0	M10xP1.5/M12xP1.75	15.0/19.0	102.0/125.0
5000	F10 & F12	35.5	27.0	35.0	M10xP1.5/M12xP1.75	15.0/19.0	102.0/125.0
11000	F14	47.5	36.0	45.0	M16xP2.0	24.0	140.0

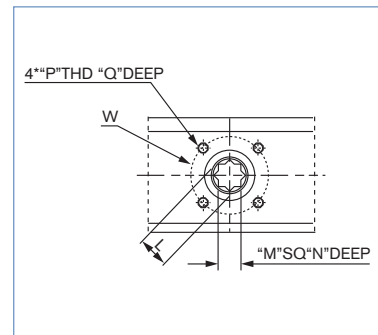

Double-square insert dimensions [mm]

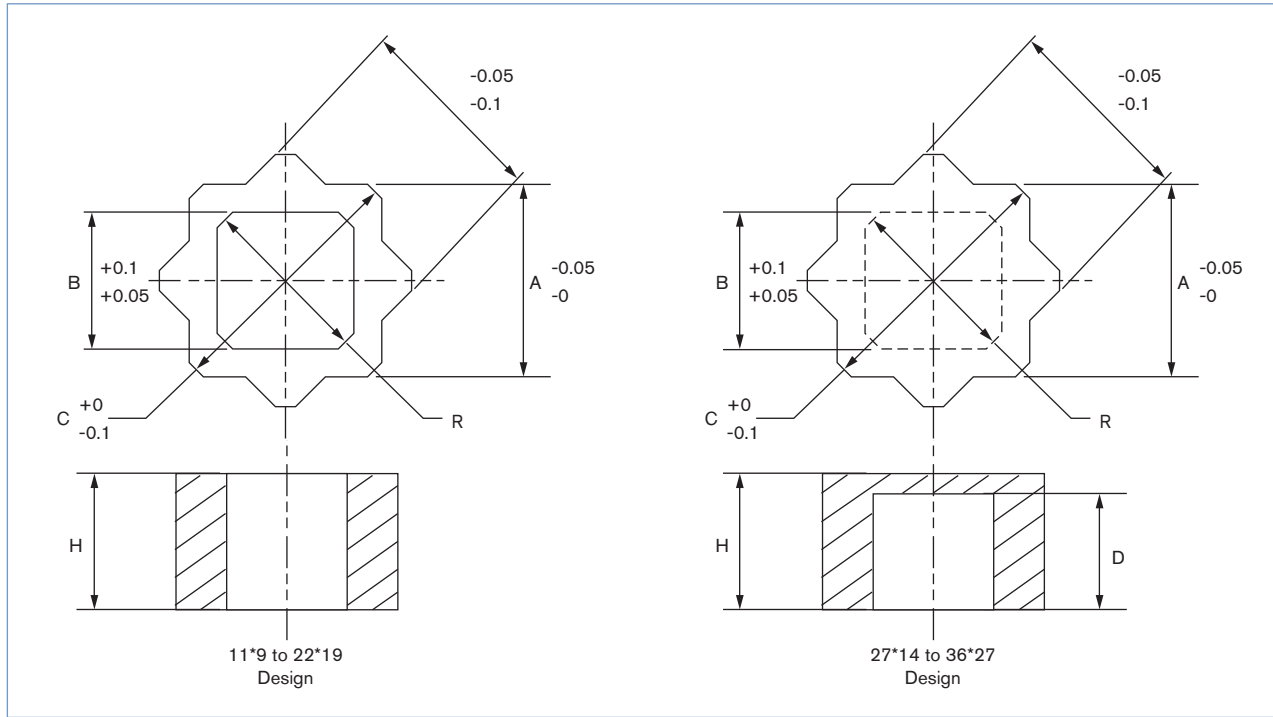

Ordering chart for shaft adapters [mm]

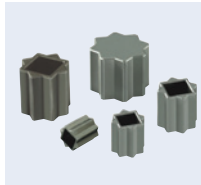

Insert	A	B	C	D	H	R	Item no.
11 * 9	11	9	15.0	-	17.0	12.5	98125211
14 * 9	14	9	19.1	-	20.0	12.5	665 288
14 * 11	14	11	19.1	-	20.0	14.5	665 289
17 * 9	17	9	23.1	-	24.0	12.5	98125212
17 * 11	17	11	23.1	-	24.0	14.5	98125213
17 * 14	17	14	23.1	-	24.0	19.2	665 290
22 * 14	22	14	29.6	-	30.0	19.2	666 684
22 * 17	22	17	29.6	-	30.0	23.3	666 685
27 * 14	27	14	36.0	27.0	29.0	19.2	98125214
27 * 17	27	17	36.0	27.0	29.0	23.3	98125215
27 * 22	27	22	36.0	27.0	29.0	30.0	98125216
36 * 27	36	27	48.0	33.0	35.0	37.0	98125217

Ordering charts for electric actuators

Note: When selecting the on/off version, we recommend a safety torque equal to 1.5 times the max break torque of the valve, and for the control version we recommend a safety torque equal to 2 times the max break torque of the valve.

For other specifications, dimensions, and electrical connections see specific datasheets.

3003 Multi-voltage actuator On/Off version

Drive stars [mm]	Conversion star sleeve included [mm]	ISO Pattern	Torque	90° rotation time ±1s	Power consumption	Voltage / frequency	Item no.
14	14/11 & 14/9	F05 (F03-F04)	20 Nm	12s	15 W	15-30VAC,50/60Hz / 12-24VDC*	225 192
14	14/11 & 14/9	F05 (F03-F04)	20 Nm	12s	15 W	100-240VAC,50/60Hz /100-350VDC	225 193
22	22/14	F05-F07	35 Nm	7s	45 W	15-30VAC,50/60Hz / 12-24VDC*	225 194
22	22/14	F05-F07	35 Nm	7s	45 W	100-240VAC,50/60Hz /100-350VDC	225 195
22	22/14	F05-F07	60 Nm	12s	45 W	15-30VAC,50/60Hz / 12-24VDC*	225 196
22	22/14	F05-F07	60 Nm	12s	45 W	100-240VAC,50/60Hz /100-350VDC	225 197
22	22/17	F05-F07	100 Nm	23s	45 W	15-30VAC,50/60Hz / 12-24VDC*	225 198
22	22/17	F05-F07	100 Nm	23s	45 W	100-240VAC,50/60Hz /100-350VDC	225 225

* The operating voltage must not fall below 11.5V

3003 Multi-voltage actuator control version, input & output signals (programmable 0-10V, 4-20ma, & 0-20ma)

Drive stars [mm]	Conversion star sleeve included [mm]	ISO Pattern	Torque	90° rotation time ±1s	Power consumption	Voltage / frequency	Item no.
14	14/11 & 14/9	F05 (F03-F04)	20 Nm	25s	15 W	15-30VAC,50/60Hz / 12-24VDC*	225 199
14	14/11 & 14/9	F05 (F03-F04)	20 Nm	25s	15 W	100-240VAC,50/60Hz /100-350VDC	225 200
22	22/14	F05-F07	35 Nm	40s	45 W	15-30VAC,50/60Hz / 12-24VDC*	225 201
22	22/14	F05-F07	35 Nm	40s	45 W	100-240VAC,50/60Hz /100-350VDC	225 202
22	22/14	F05-F07	60 Nm	79s	45 W	15-30VAC,50/60Hz / 12-24VDC*	225 203
22	22/14	F05-F07	60 Nm	79s	45 W	100-240VAC,50/60Hz /100-350VDC	225 204
22	22/17	F05-F07	100 Nm	119s	45 W	15-30VAC,50/60Hz / 12-24VDC*	225 205
22	22/17	F05-F07	100 Nm	119s	45 W	100-240VAC,50/60Hz /100-350VDC	225 206

* The operating voltage must not fall below 11.5V

3005 Multi-voltage actuator On/Off version

Drive stars [mm]	Conversion star sleeve included [mm]	ISO Pattern	Torque	90° rotation time ±1s	Power consumption	Voltage / frequency	Item no.
22	22/17	F07-F10	150 Nm	30s	45 W	100-240VAC, 50/60Hz	181 303
22	22/17	F07-F10	150 Nm	30s	45 W	24V AC/DC	181 304
22	22/17	F07-F10	300 Nm	50s	85 W	100-240VAC, 50/60Hz	181 305
22	22/17	F07-F10	300 Nm	50s	85 W	24V AC/DC	181 306

3005 Multi-voltage actuator control version, input & output signals (programmable 0-10V, 4-20ma, & 0-20ma)

Drive stars [mm]	Conversion star sleeve included [mm]	ISO Pattern	Torque	90° rotation time ±1s	Power consumption	Voltage / frequency	Item no.
22	22/17	F07-F10	150 Nm	30s	45 W	100-240VAC, 50/60Hz	181 293
22	22/17	F07-F10	150 Nm	30s	45 W	24V AC/DC	179 725
22	22/17	F07-F10	300 Nm	50s	85 W	100-240VAC, 50/60Hz	181 307
22	22/17	F07-F10	300 Nm	50s	85 W	24V AC/DC	179 726

Ordering charts for electric actuators (continued...)

3004 Ex actuator On/Off version (ATEX II 2 GD Ex d II B T6)

Drive stars [mm]	Conversion star sleeve included [mm]	ISO Pattern	Torque	90° rotation time ±1s	Power consumption	Voltage / frequency	Item no.
17	17/11	F05-F07	25 Nm	7s	45 W	100-240VAC, 50/60Hz	181 308
17	17/11	F05-F07	25 Nm	7s	45 W	24V AC/DC	181 309
17	17/14	F05-F07	45 Nm	15s	45 W	100-240VAC, 50/60Hz	181 310
17	17/14	F05-F07	45 Nm	15s	45 W	24V AC/DC	181 311
17	17/14	F05-F07	75 Nm	20s	45 W	100-240VAC, 50/60Hz	181 312
17	17/14	F05-F07	75 Nm	20s	45 W	24V AC/DC	181 313
22	22/17	F07-F10	100 Nm	15s	45 W	100-240VAC, 50/60Hz	181 314
22	22/17	F07-F10	100 Nm	15s	45 W	24V AC/DC	181 315
22	22/17	F07-F10	150 Nm	30s	45 W	100-240VAC, 50/60Hz	181 316
22	22/17	F07-F10	150 Nm	30s	45 W	24V AC/DC	181 317
22	22/17	F07-F10	300 Nm	50s	85 W	100-240VAC, 50/60Hz	181 318
22	22/17	F07-F10	300 Nm	50s	85 W	24V AC/DC	181 319

3004 Ex actuator control version (ATEX II 2 GD Ex d II B T6),
input & output signals (programmable 0-10V, 4-20ma, & 0-20ma)

Drive stars [mm]	Conversion star sleeve included [mm]	ISO Pattern	Torque	90° rotation time ±1s	Power consumption	Voltage / frequency	Item no.
17	17/11	F05-F07	25 Nm	15s	45 W	100-240VAC, 50/60Hz	182 324
17	17/11	F05-F07	25 Nm	15s	45 W	24V AC/DC	182 326
17	17/14	F05-F07	45 Nm	15s	45 W	100-240VAC, 50/60Hz	182 327
17	17/14	F05-F07	45 Nm	15s	45 W	24V AC/DC	182 330
17	17/14	F05-F07	75 Nm	20s	45 W	100-240VAC, 50/60Hz	182 335
17	17/14	F05-F07	75 Nm	20s	45 W	24V AC/DC	182 384
22	22/17	F07-F10	100 Nm	15s	45 W	100-240VAC, 50/60Hz	182 385
22	22/17	F07-F10	100 Nm	15s	45 W	24V AC/DC	182 386
22	22/17	F07-F10	150 Nm	30s	45 W	100-240VAC, 50/60Hz	182 388
22	22/17	F07-F10	150 Nm	30s	45 W	24V AC/DC	182 390
22	22/17	F07-F10	300 Nm	50s	85 W	100-240VAC, 50/60Hz	182 392
22	22/17	F07-F10	300 Nm	50s	85 W	24V AC/DC	182 394

Ordering chart for accessories

For other specifications, dimensions, and electrical connections see specific datasheets.

NAMUR pilot valve 6519 with 5/2 & 3/2 way

Circuit function	Orifice [mm]	Q _N valve air [l/min]	C _v	Seal material	Socket connection material	Voltage / frequency	UR Item no.
W	6.0	900	1.3	NBR & PUR	Brass, nickle-plated	24V DC 2W	132 727
						24V 60Hz 2W	420 843
						120V 60Hz 2W	420 844
						240V 60Hz 2W	420 845
W	6.0	900	1.3	NBR & PUR	Stainless Steel	24V DC 2W	458 411
						24V 60Hz 2W	458 410
						120V 60Hz 2W	458 412
						240V 60Hz 2W	458 413

Limit switch boxes

Type	Ambient temperature	Protection class	Position feedback	Position indicator	Cable Entry	Item no.
APL-210N	-4°F to 176°F (-20°C to +80°C)	IP67/NEMA 4 & 4X	2 SPDT Mechanical	Closed(red), Open(Yellow)	2 x 1/2" NPT	98125280
E-07	-4°F to 185°F (-20°C to +85°C)	Exd II CT6	2 SPDT Mechanical	Closed(red), Open(Yellow)	2 x 3/4" NPT	98125281
APL-510N	-4°F to 140°F (-20°C to +60°C)	IP67/NEMA4,4X,7,9 E Ex d IIC T6	2 SPDT Mechanical	Closed(red), Open(Yellow)	2 x 3/4" NPT	98125282

Ordering chart for ISO Pattern screw sets [mm]

ISO Pattern	4 x Socket Set Screw DIN 916 A2 S/S 18-8	Includes 4 x Flat Washer Din 125 A4 S/S 18-8	4 x Metric Hex Nut DIN 934 A2 S/S 18-8	Item no.
F04	M5 - 0.8 x 25	M5 - 5.3 x 10	M5 - 0.8 x 8 x 4	98125298
F05	M6 - 1 x 25	M6 - 6.4 x 12	M6 - 1 x 10 x 5	98125299
F07	M8 - 1.25 x 25	M8 - 8.4 x 16	M8 - 1.25 x 13 x 6.5	98125300
F10	M10 - 1.5 x 35	M10 - 10.5 x 20	M10 - 1.5 x 17 x 8	98125301
F12	M12 - 1.75 x 40	M12 - 13 x 24	M12 - 1.75 x 19 x 10	98125302
F14	M16 - 2 x 40	M16 - 17 x 28	M16 - 2 x 24 x 13	98125303

Note

You can fill out the fields directly in the PDF file before printing out the form.

Request for quotation

▶ Please fill out and send to your nearest Burkert facility* with your inquiry or order







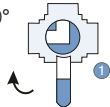
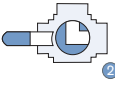

Company	Contact person
Customer no.	Department
Address	Tel./Fax
ZIP code	E-Mail

= mandatory fields to fill out Quantity Required delivery date

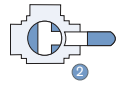
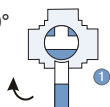
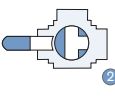
Operating data

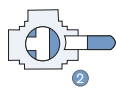
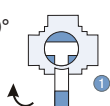
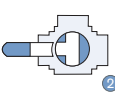
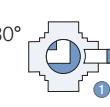
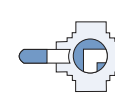
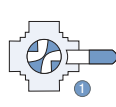
<input type="checkbox"/> Process medium	<input type="text"/>		
<input type="checkbox"/> Type of medium	<input type="checkbox"/> Liquid	<input type="checkbox"/> Steam	<input type="checkbox"/> Gas
	Min	Standard	Max
<input type="checkbox"/> Flow rate	<input type="text"/>	<input type="text"/>	<input type="text"/>
<input type="checkbox"/> Temperature	<input type="text"/>	<input type="text"/>	<input type="text"/>
<input type="checkbox"/> Pressure	<input type="text"/>	<input type="text"/>	<input type="text"/>

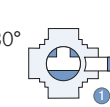
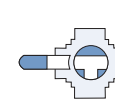
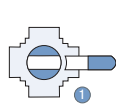
Valve features

Body type	<input type="checkbox"/> 2pc [2]	<input type="checkbox"/> 3pc [3]	<input type="checkbox"/> Top Entry [T]	<input type="checkbox"/> Multi-Port [M]
Ports	<input type="checkbox"/> 2 Way [2]	<input type="checkbox"/> 3 Way [3]	<input type="checkbox"/> 4 Way [4]	
Connection	<input type="checkbox"/> ANSI 150lb Flange [FA]	<input type="checkbox"/> NPT [NM]	<input type="checkbox"/> OD Tube Butt Weld [SA]	
	<input type="checkbox"/> Sch 40 Butt Weld [SC]	<input type="checkbox"/> Sch 40 Socket Weld [SM]	<input type="checkbox"/> ASME BPE Clamp [TG]	
Size	<input type="checkbox"/> 1/4" <input type="checkbox"/> 3/8" <input type="checkbox"/> 1/2" <input type="checkbox"/> 3/4" <input type="checkbox"/> 1" <input type="checkbox"/> 1 1/4" <input type="checkbox"/> 1 1/2" <input type="checkbox"/> 2" <input type="checkbox"/> 2 1/2"			
	<input type="checkbox"/> 3" <input type="checkbox"/> 4" <input type="checkbox"/> 6" <input type="checkbox"/> 8"			
Seals	<input type="checkbox"/> PTFE	<input type="checkbox"/> TFM		
Actuation	<input type="checkbox"/> Pneumatic [P]	<input type="checkbox"/> Electric [E]		
Pneumatic				
Size	<input type="checkbox"/> 125 <input type="checkbox"/> 250 <input type="checkbox"/> 450 <input type="checkbox"/> 1000 <input type="checkbox"/> 2250 <input type="checkbox"/> 3650			
	<input type="checkbox"/> 5000 <input type="checkbox"/> 11000			
Spring set	<input type="checkbox"/> R3 <input type="checkbox"/> R4			
Electric				
Type	<input type="checkbox"/> 3003 <input type="checkbox"/> 3004 <input type="checkbox"/> 3005			
Voltage	<input type="checkbox"/> 15-30 AC <input type="checkbox"/> 12-24 DC <input type="checkbox"/> 100-240 AC <input type="checkbox"/> 100-350 DC			
Function				
2-way	<input type="checkbox"/> Normally Closed [A]	<input type="checkbox"/> Normally Open [B]	<input type="checkbox"/> Double acting [I]	
3-way	<input type="checkbox"/> L3-90° 		<input type="checkbox"/> T5-90° 	
	<input type="checkbox"/> T3-90° 		<input type="checkbox"/> T6-90° 	
	<input type="checkbox"/> T4-90° 			
4-way	<input type="checkbox"/> L5-180° 		<input type="checkbox"/> X-90° 	
	<input type="checkbox"/> T5-180° 		<input type="checkbox"/> I-90° 	

continued on next page →

Accessories

	<input type="checkbox"/> Pilot Valve [PV]	<input type="checkbox"/> Limit Switch [LS]	<input type="checkbox"/> Control Top [CT]
Pilot valve voltage	<input type="checkbox"/> 24 DC	<input type="checkbox"/> 24 AC	<input type="checkbox"/> 120 AC <input type="checkbox"/> 240 AC
Limit switch type	<input type="checkbox"/> APL-210	<input type="checkbox"/> E-07	<input type="checkbox"/> APL-510N
Control top type	<input type="checkbox"/> 8791	<input type="checkbox"/> 8792	<input type="checkbox"/> 8793

Control unit features

Click on the orange box "More info." below... you will come to our website for the resp. product where you can download the datasheet.

Basic positioner	Positioner	Process controller
<input type="checkbox"/> Type 8791	<input type="checkbox"/> Type 8792	<input type="checkbox"/> Type 8793
Power supply 24VDC	Power supply 24VDC	Power supply 24VDC
Feedback	Communication	Communication
<input type="checkbox"/> Without	<input type="checkbox"/> Without	<input type="checkbox"/> Without
<input type="checkbox"/> Analog feedback	<input type="checkbox"/> Profibus DPV 1	<input type="checkbox"/> Profibus DPV 1
Electrical connection	Feedback	Feedback
<input type="checkbox"/> Cable gland	<input type="checkbox"/> Without	<input type="checkbox"/> Without
<input type="checkbox"/> Multi-pole	<input type="checkbox"/> 2 binary outputs	<input type="checkbox"/> 2 binary outputs
	<input type="checkbox"/> Analog feedback + 2 binary outputs	<input type="checkbox"/> Analog feedback + 2 binary outputs
	Electrical connection	Electrical connection
	<input type="checkbox"/> Cable gland	<input type="checkbox"/> Cable gland
	<input type="checkbox"/> Multi-pole	<input type="checkbox"/> Multi-pole
Please specify item no. if known:	Please specify item no. if known:	Please specify item no. if known:
<input type="text"/>	<input type="text"/>	<input type="text"/>

Comment / sketch

DTS 1000152215 EN Version: D Status: RL (released | freigegeben | validé) printed: 18.12.2024