

## Cable plug with electronic booster

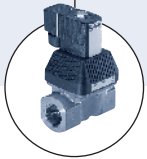

Type 2511 can be combined with...



Solenoid valve with  
Industrial standard Type A connection

The cable plug Type 2511 with electronic booster increases the output of single solenoid valves. The adjustable pressure range can be extended. Also the power consumption and the coil temperature can be reduced considerably e.g. with continuous operation. The use with suitable solenoid coils must be set for the respective valve and supply voltage. Please contact your nearest Buerkert sales office for help in this respect.

The high switching power is produced by over-excitation. After switching the valve electronic decreases to a small holding capacity. The 24V DC version automatically detects the switching point and changes to the phase with reduced performance, while in the other versions the over-excitation phase remains constant at 400ms. Further with the 24V version the voltage signal is displayed on an LED.

- Increased performance from Solenoid valves
- High switching power
- Version for 24V with switching point detection for reduced power consumption and LED indicator

Technical data	24V	110-230V
<b>Body material</b>	Polyamide	Polyamid
<b>Body front</b>	Ultrasound, transparent grey	Polysulfon
<b>Contact material</b>	Brass, galvanised silver-plated	Brass, galvanised silver-plated
<b>Contact distance</b>	18mm acc. to DIN EN 175301-803 (previously DIN 43650, Form A)	18mm acc. to DIN EN 175301-803 (previously DIN 43650, Form A)
<b>Operating voltage <math>U_{nom}</math></b>	24V AC/DC Supply voltage acc. to IEC 364-4-41 (PELV)	110-230V AC/DC
<b>Max. pull-in power</b>	72W	72W
<b>Pull-in time</b>	AC: 400ms / DC: variable	400ms
<b>Holding power</b>	4W	4W
<b>Duty cycle ED</b>	10/min	10/min
<b>Off-time between switching operations</b>	min. 1s	min. 1s
<b>Connection</b>	2-pin terminal strip wire gauge: max. 1.5mm <sup>2</sup> Cable diameter: 6-7mm	3-pin terminal strip wire gauge: max. 1,5mm <sup>2</sup> Cable diameter: 6-7mm
<b>Earth conductor</b>	no	yes
<b>Operating temperature</b>	14°F to 131°F (-10°C to 55°C)	14°F to 131°F (-10°C to 55°C)
<b>Protection class</b>	IP65	IP65
<b>Switch point detection</b>	AC: no / DC: yes	no
<b>LED indicator</b>	green	no

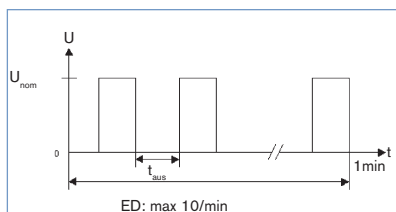

Connection diagram

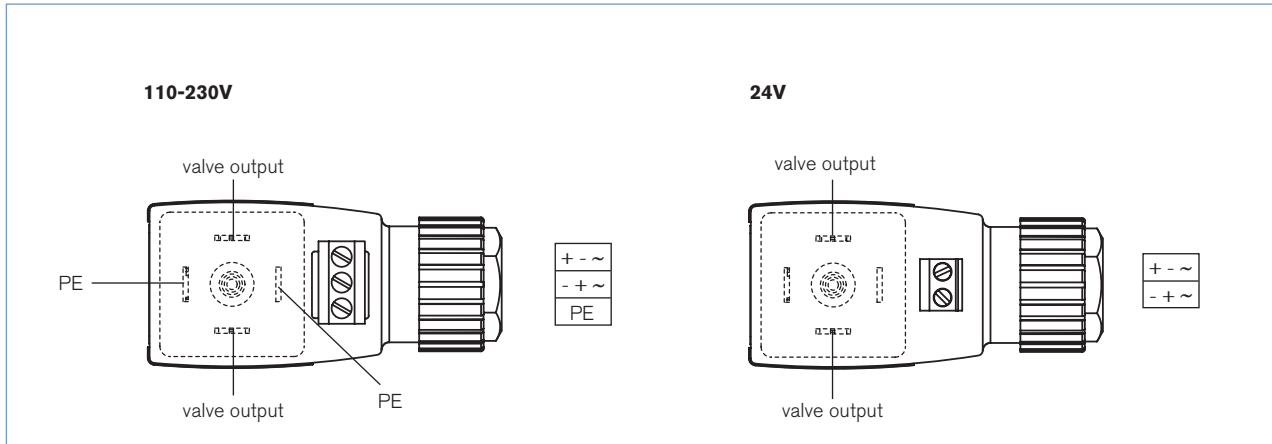

Ordering chart

Operating voltage	Item no.
24V AC/DC	181 630
110-230V AC/DC	138 306

Dimensions [mm]

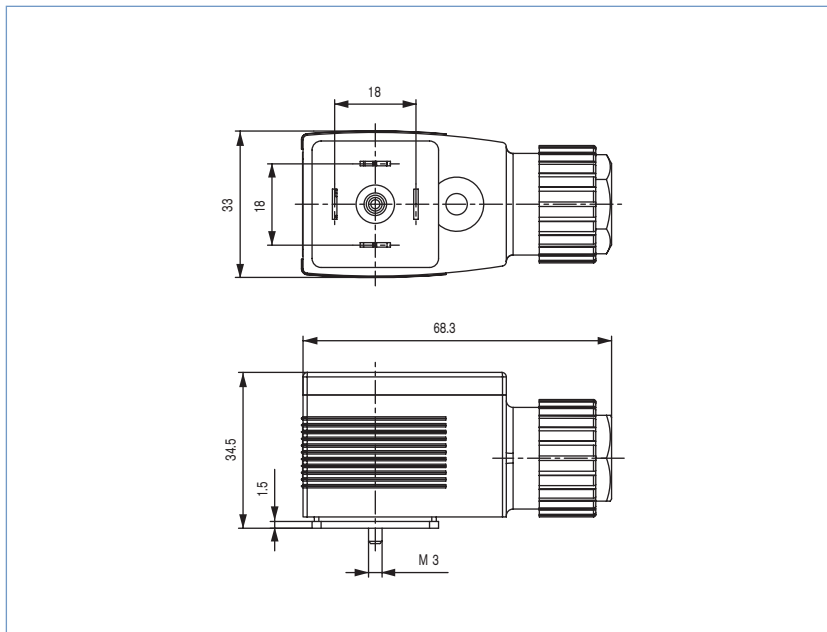

DTS 1000082423 EN Version: E Status: RL (released | freigegeben | validé) printed: 18.12.2024