



## Pneumatically operated 2-way angle seat control valve ELEMENT

- Excellent combination of good control characteristic and high flow rate
- Long service life
- Control units can be mounted directly without external tubing
- Stainless steel housing with thread, clamp and weld end connection

Product variants described in the data sheet may differ from the product presentation and description.

### Can be combined with

	<b>Type 8696</b> Digital electropneumatic positioner for integrated mounting on process control valves	▶
	<b>Type 8693</b> Digital electropneumatic process controller for integrated mounting on process control valves	▶
	<b>Type 8692</b> Digital electro-pneumatic positioner for integrated mounting on process control valves	▶
	<b>Type 8694</b> Digital electropneumatic positioner for integrated mounting on process control valves	▶
	<b>Type 8792</b> Digital electropneumatic positioner SideCONTROL	▶
	<b>Type 8793</b> Digital electropneumatic Process Controller SideCONTROL	▶
	<b>Type 8791</b> Digital electropneumatic positioner SideCONTROL	▶
	<b>Type 8802</b> ELEMENT continuous control valve systems – overview	▶

### Type description

In line with Bürkert's philosophy for modular valves and sensors the construction of Type 2300 angle-seat valve fulfils tough criteria for process environments. Unrivalled cycle life and sealing integrity is guaranteed by the proven self adjusting packing gland. The parabolic trim results in a flow characteristic approximately 35 % larger than conventional control valves. It is available in either stainless steel or with a durable PTFE seal for tight shut-off. The design enables the easy integration of automation modules whether they are digital electropneumatic positioner or process controller. The fully integrated system has a compact and smooth design, integrated pneumatic lines, IP65/67, NEMA Type 4X protection class and superior chemical resistance. This system has been engineered for reliable accurate control in applications where high flow rate is an advantage.

DTS 1000475061 EN Version: J Status: RL (released | freigegeben | validé) printed: 20.02.2025

## Table of contents

<b>1. General technical data</b>	<b>3</b>
<b>2. Control functions</b>	<b>4</b>
<b>3. Approvals and conformities</b>	<b>4</b>
3.1. General notes .....	4
3.2. Conformity .....	4
3.3. Standards .....	4
3.4. Explosion protection .....	4
3.5. Drinking water .....	5
3.6. Foods and beverages/Hygiene .....	5
3.7. Others .....	5
Oxygen .....	5
<b>4. Materials</b>	<b>6</b>
4.1. Bürkert resistApp .....	6
4.2. Material specifications .....	6
<b>5. Dimensions</b>	<b>7</b>
5.1. Actuator .....	7
Valve system Continuous ELEMENT .....	8
5.2. Body with threaded connection .....	10
5.3. Body with welded connection .....	11
5.4. Body with clamp connection .....	12
<b>6. Performance specifications</b>	<b>13</b>
6.1. Fluidic data .....	13
Flow characteristics .....	13
Overview of fluidic data for flow below seat (for liquids, steam and gases) .....	13
Pilot pressure diagram with flow direction below seat (control function B) .....	14
6.2. Operating limits .....	15
Operating limits for medium temperature and operating pressure .....	15
Operating limits for ambient and medium temperature .....	16
Operating limits for seat seal .....	16
Operating limits for optional versions .....	17
<b>7. Product accessories</b>	<b>17</b>
<b>8. Networking and combination with other Bürkert products</b>	<b>21</b>
<b>9. Ordering information</b>	<b>23</b>
9.1. Bürkert eShop .....	23
9.2. Bürkert product filter .....	23
9.3. Bürkert Product Enquiry Form .....	23
9.4. Ordering chart threaded connection .....	24
Valves with flow direction below seat .....	24
9.5. Ordering chart welded connection .....	26
Valves with flow direction below seat .....	26
9.6. Ordering chart clamp connection .....	28
Valves with flow direction below seat .....	28

## 1. General technical data

<b>Product properties</b>	
Dimensions	Further information can be found in chapter <b>"5. Dimensions"</b> on page 7.
Material	Further information can be found in chapter <b>"4. Materials"</b> on page 6.
Design	Angle seat control valve
Nominal diameter (port connection)	DN 10...DN 65, NPS 3/8...NPS 2 1/2
Safety setting in case of power failure	Normally closed (control function A), normally open (control function B)
Flow direction	Flow to open (below seat)
<b>Performance data</b>	
Operating pressure	0 bar(g)...25 bar(g), vacuum versions up to -0.9 bar(g) (option) (see <b>"6.1. Fluidic data"</b> on page 13)
Nominal pressure	PN 25 (DIN EN 1333), Class 150 (DIN EN 1759)
Pilot pressure	5.6 bar(g)...7 bar(g) (see <b>"6.1. Fluidic data"</b> on page 13)
Seat leakage	DIN EN 60534 - 4:2006 (see <b>"6.1. Fluidic data"</b> on page 13)
Leakage class III and IV	Stainless steel
Leakage class VI	PTFE and PEEK
K <sub>v</sub> value	5 m <sup>3</sup> /h...90 m <sup>3</sup> /h (see <b>"6.1. Fluidic data"</b> on page 13)
Operating characteristic	Modified equal percentage
<b>Medium data</b>	
Process medium	Steam, water, neutral gases, alcohols, oils, fuels, hydraulic fluids, salt solutions, alkalis, organic solvents and oxygen
Medium temperature	-40 °C...+230 °C (see <b>"6.2. Operating limits"</b> on page 15)
Viscosity	Max. 600 mm <sup>2</sup> /s
Control medium	Air, neutral gases
<b>Process/Port connection &amp; communication</b>	
<b>Port connection</b>	
Threaded connection	G (DIN ISO 228 - 1) NPT (ASME B1.20.1) RC (ISO 7 - 1)
Welded connection	DIN EN ISO 1127 / ISO 4200 / DIN 11866 series B DIN 11850 - 2 / DIN 11866 series A ASME BPE / DIN 11866 series C SMS 3008
Clamp connection	DIN 32676 series B (pipe: ISO 4200) DIN 32676 series A (pipe: DIN 11850 - 2) ASME BPE
<b>Approvals and conformities</b>	
Further information can be found in chapter <b>"3. Approvals and conformities"</b> on page 4.	
Material certificate	2.2, 3.1
<b>Environment and installation</b>	
Ambient temperature	-10 °C...+80 °C (with remote sensor Type 8798 for positioner or process controller, Type 8791/8792/8793) -10 °C...+55 °C (with positioner or process controller, Type 8692/8693/8694)
Degree of protection	IP65/67
Installation position	As required, preferably with actuator in upright position

## 2. Control functions

Symbol	Description	
<b>Flow direction below seat for fluids, steam and gases</b>		
	<p><b>Control function A (CF A)</b>                      Pneumatically operated 2/2-way on/off valve                      Flow direction below seat                      Normally closed by spring force</p>	
	<p><b>Control function B (CF B)</b>                      Pneumatically operated 2/2-way on/off valve                      Flow direction below seat                      Normally opened by spring force</p>	

## 3. Approvals and conformities

### 3.1. General notes

- The approvals and conformities listed below must be stated when making enquiries. This is the only way to ensure that the product complies with all required specifications.
- Not all available versions can be supplied with the below mentioned approvals or conformities.

### 3.2. Conformity

In accordance with the Declaration of Conformity, the product is compliant with the EU Directives. This includes the following directives:

- Pressure Equipment Directive 2014/68/EU
- Machinery Directive 2006/42/EG

### 3.3. Standards

The applied standards which are used to demonstrate compliance with the EU Directives are listed in the EU-Type Examination Certificate and/or the EU Declaration of Conformity.

### 3.4. Explosion protection

Approval	Description																
	<p><b>Optional: Explosion protection (valid for the variable code PX51)</b>                      As a category 2 device suitable for zone 1/21 and zone 2/22.</p> <p><b>ATEX:</b>                      EPS 18 ATEX 2 008 X                      II 2G Ex h IIC T4...T2 Gb                      II 2D Ex h IIIC T135 °C...T300 °C Db</p> <p><b>IECEx:</b>                      IECEx EPS 18.0007X                      Ex h IIC T4...T2 Gb                      Ex h IIIC T135 °C...T300 °C Db</p> <table border="1"> <thead> <tr> <th>Temperature class</th> <th>T2</th> <th>T3</th> <th>T4</th> </tr> </thead> <tbody> <tr> <td>Maximum surface temperature</td> <td>+ 300 °C</td> <td>+ 200 °C</td> <td>+ 135 °C</td> </tr> <tr> <td>Ambient temperature</td> <td>- 40...+ 130 °C</td> <td>- 40...+ 130 °C</td> <td>- 40...+ 100 °C</td> </tr> <tr> <td>Maximum medium temperature</td> <td>+ 285 °C</td> <td>+ 185 °C</td> <td>+ 125 °C</td> </tr> </tbody> </table> <p><b>Note:</b> The ambient and medium temperature range may be limited by non-ex-relevant specifications. Observe the Operating Instructions.</p>	Temperature class	T2	T3	T4	Maximum surface temperature	+ 300 °C	+ 200 °C	+ 135 °C	Ambient temperature	- 40...+ 130 °C	- 40...+ 130 °C	- 40...+ 100 °C	Maximum medium temperature	+ 285 °C	+ 185 °C	+ 125 °C
Temperature class	T2	T3	T4														
Maximum surface temperature	+ 300 °C	+ 200 °C	+ 135 °C														
Ambient temperature	- 40...+ 130 °C	- 40...+ 130 °C	- 40...+ 100 °C														
Maximum medium temperature	+ 285 °C	+ 185 °C	+ 125 °C														

### 3.5. Drinking water

Conformity	Description
	<p><b>Suitable for use in drinking water applications</b>                      The materials comply with the assessment principles (UBA) for materials in contact with drinking water (TrinkwasserV).</p> <p><b>Stainless steel body</b>                      PF39: Suitable for products with medium temperature up to 85 °C (hot water)</p>

### 3.6. Foods and beverages/Hygiene

Conformity	Description
	<p><b>FDA – Code of Federal Regulations (valid for the variable code PL02)</b>                      All wetted materials are compliant with the Code of Federal Regulations published by the FDA (Food and Drug Administration, USA) according to the manufacturer’s declaration.</p>
	<p><b>EC Regulation 1935/2004 of the European Parliament and of the Council (valid for the variable code PL01, PL02)</b>                      All wetted materials are compliant with EC Regulation 1935/2004/EC according to the manufacturer’s declaration.</p>
	<p><b>China food GB Standards of the People’s Republic of China (valid for the variable code PL10)</b>                      All wetted materials are compliant with the requirement of China food GB Standards according to the manufacturer’s declaration.</p>

### 3.7. Others

#### Oxygen

Conformity	Description
	<p><b>Optional: Suitability for oxygen (valid for the variable code NL02)</b>                      The products are suitable for use with gaseous oxygen, according to the manufacturer’s declaration.</p>

DTS 1000475061 EN Version: J Status: RL (released | freigegeben | valide) printed: 20.02.2025

## 4. Materials

### 4.1. Bürkert resistApp



#### Bürkert resistApp – Chemical resistance chart

You want to ensure the reliability and durability of the materials in your individual application case? Verify your combination of media and materials on our website or in our resistApp.

[Start chemical resistance check](#)

### 4.2. Material specifications

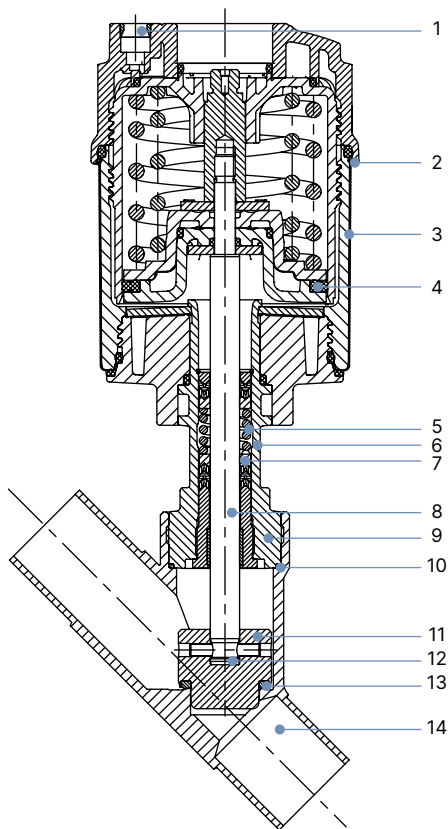

No.	Element	Material
1	Pilot air ports	Push-in connector PP (standard)
2	Actuator	PPS
3	Cover	Stainless steel 1.4561 (316Ti)
4	Piston seal	FKM
5	Spring	Stainless steel 1.4310
6	Pipe	Stainless steel CF3M
7	Spindle seal	PTFE V-rings (filled), with spring compensation
8	Spindle	Stainless steel 1.4401 (316)/1.4404 (316L)
9	Spindle guide	Stainless steel 1.4404 (316L)
10	Body seal	Graphite or PTFE
11	Control cone	Stainless steel 1.4571
12	Spring pin	Stainless steel 1.4310
13	Seat seal	Stainless steel 1.4571, PTFE or PEEK
14	Valve body	Stainless steel CF3M

## 5. Dimensions

### 5.1. Actuator

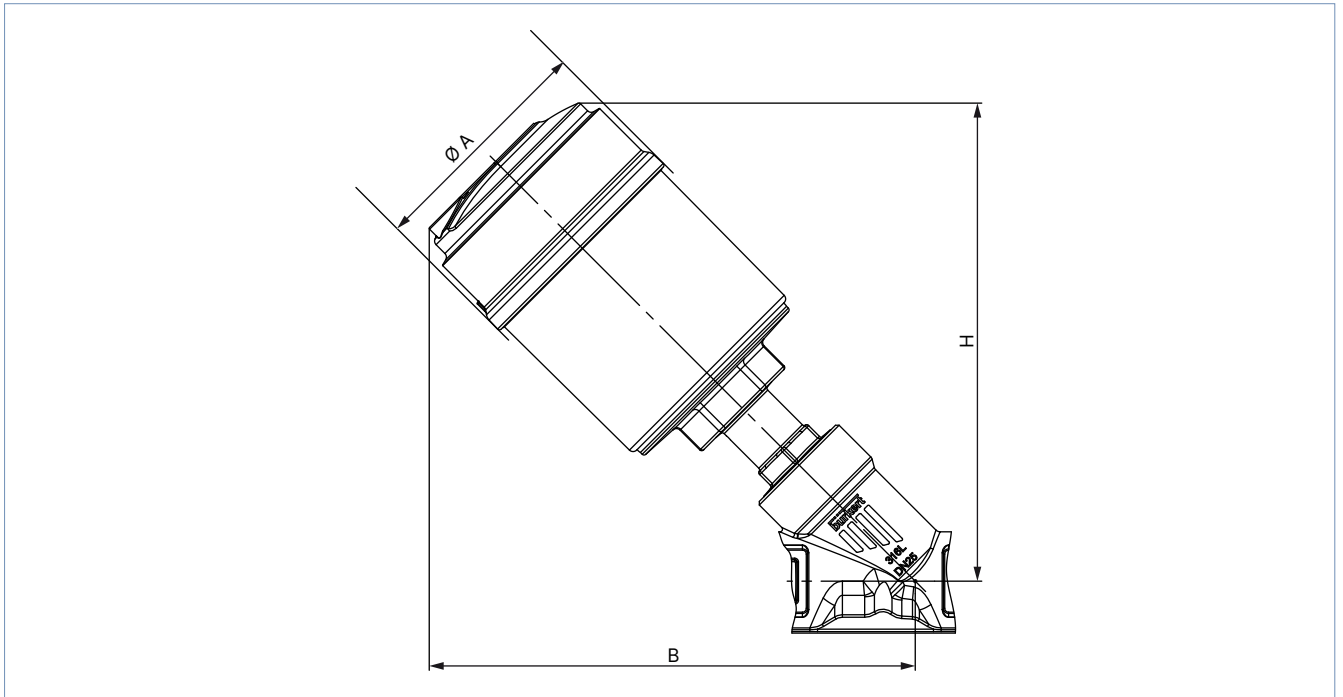

Nominal diameter (port connection)		Actuator size	Ø A	B <sup>1)</sup>	H <sup>1)</sup>
DN	NPS				
10	3/8	50 (D)	64.5	166	163
		70 (M)	91	182	178
15	1/2	50 (D)	64.5	166	163
		70 (M)	91	182	178
20	3/4	50 (D)	64.5	174	171
		70 (M)	91	189	186
25	1	50 (D)	64.5	175	173
		70 (M)	91	191	188
		90 (N)	120	228	227
32	1 1/4	90 (N)	120	201	197
		130 (P)	159	243	242
40	1 1/2	90 (N)	120	247	246
		130 (P)	159	296	296
50	2	90 (N)	120	262	261
		130 (P)	159	312	312
65	2 1/2	130 (P)	159	342	342

1.) The dimensions for B and H are maximum dimensions and may be up to 6 mm less, depending on the nominal diameter (port connection) and standard.

**Valve system Continuous ELEMENT**

**Note:**

- Dimensions in mm
- Please note actuator size A in table "5.1. Actuator" on page 7

With positioner TopControl Type 8692 ▶ or with process controller TopControl Type 8693 ▶		With positioner TopControl Basic Type 8694 ▶																																																																											
With positioner TopControl Type 8696 ▶		<table border="1"> <thead> <tr> <th colspan="2">Nominal diameter (port connection)</th> <th rowspan="2">Actuator size</th> <th colspan="2">B/H<sup>1)</sup> with</th> </tr> <tr> <th>DN</th> <th>NPS</th> <th>Type 8692 or Type 8693</th> <th>Type 8694 or Type 8696</th> </tr> </thead> <tbody> <tr> <td rowspan="2">10</td> <td rowspan="2">3/8</td> <td>50 (D)</td> <td>–</td> <td>239</td> </tr> <tr> <td>70 (M)</td> <td>285</td> <td>257</td> </tr> <tr> <td rowspan="2">15</td> <td rowspan="2">1/2</td> <td>50 (D)</td> <td>–</td> <td>239</td> </tr> <tr> <td>70 (M)</td> <td>285</td> <td>257</td> </tr> <tr> <td rowspan="2">20</td> <td rowspan="2">3/4</td> <td>50 (D)</td> <td>–</td> <td>247</td> </tr> <tr> <td>70 (M)</td> <td>293</td> <td>264</td> </tr> <tr> <td rowspan="3">25</td> <td rowspan="3">1</td> <td>50 (D)</td> <td>–</td> <td>249</td> </tr> <tr> <td>70 (M)</td> <td>295</td> <td>266</td> </tr> <tr> <td>90 (N)</td> <td>332</td> <td>303</td> </tr> <tr> <td rowspan="2">32</td> <td rowspan="2">1 1/4</td> <td>90 (N)</td> <td>304</td> <td>276</td> </tr> <tr> <td>130 (P)</td> <td>347</td> <td>318</td> </tr> <tr> <td rowspan="2">40</td> <td rowspan="2">1 1/2</td> <td>90 (N)</td> <td>351</td> <td>322</td> </tr> <tr> <td>130 (P)</td> <td>387</td> <td>359</td> </tr> <tr> <td rowspan="2">50</td> <td rowspan="2">2</td> <td>90 (N)</td> <td>366</td> <td>337</td> </tr> <tr> <td>130 (P)</td> <td>403</td> <td>375</td> </tr> <tr> <td>65</td> <td>2 1/2</td> <td>130 (P)</td> <td>433</td> <td>405</td> </tr> </tbody> </table>			Nominal diameter (port connection)		Actuator size	B/H <sup>1)</sup> with		DN	NPS	Type 8692 or Type 8693	Type 8694 or Type 8696	10	3/8	50 (D)	–	239	70 (M)	285	257	15	1/2	50 (D)	–	239	70 (M)	285	257	20	3/4	50 (D)	–	247	70 (M)	293	264	25	1	50 (D)	–	249	70 (M)	295	266	90 (N)	332	303	32	1 1/4	90 (N)	304	276	130 (P)	347	318	40	1 1/2	90 (N)	351	322	130 (P)	387	359	50	2	90 (N)	366	337	130 (P)	403	375	65	2 1/2	130 (P)	433	405
Nominal diameter (port connection)		Actuator size	B/H <sup>1)</sup> with																																																																										
DN	NPS		Type 8692 or Type 8693	Type 8694 or Type 8696																																																																									
10	3/8	50 (D)	–	239																																																																									
		70 (M)	285	257																																																																									
15	1/2	50 (D)	–	239																																																																									
		70 (M)	285	257																																																																									
20	3/4	50 (D)	–	247																																																																									
		70 (M)	293	264																																																																									
25	1	50 (D)	–	249																																																																									
		70 (M)	295	266																																																																									
		90 (N)	332	303																																																																									
32	1 1/4	90 (N)	304	276																																																																									
		130 (P)	347	318																																																																									
40	1 1/2	90 (N)	351	322																																																																									
		130 (P)	387	359																																																																									
50	2	90 (N)	366	337																																																																									
		130 (P)	403	375																																																																									
65	2 1/2	130 (P)	433	405																																																																									

1.) The dimensions for B and H are maximum dimensions and may be up to 6 mm less, depending on the nominal diameter (port connection) and standard.

DTS 1000475061 EN Version: J Status: RL (released | freigegeben | validé) printed: 20.02.2025



With remote positioner SideControl Type 8792 ▶ or with remote process controller SideControl Type 8793 ▶

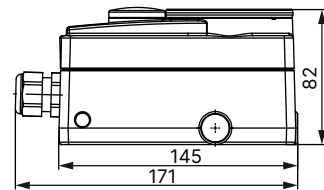
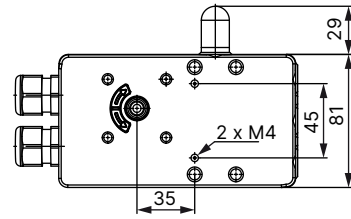
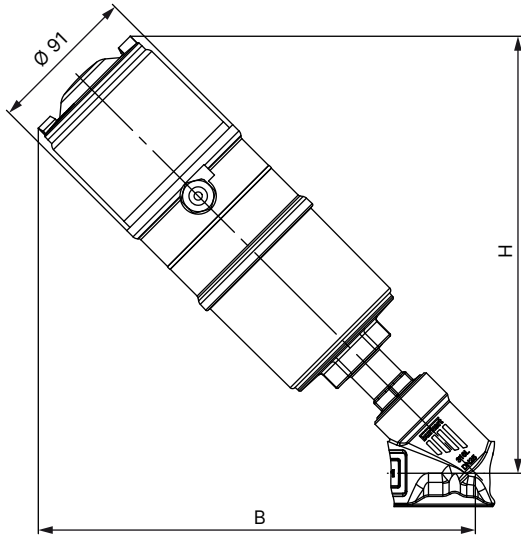

Nominal diameter (port connection)		Actuator size	B / H with 8792 or 8793
DN	NPS		
10	3/8	70 (M)	257
15	1/2	70 (M)	257
20	3/4	70 (M)	264
25	1	70 (M)	266
		90 (N)	303
32	1 1/4	90 (N)	276
		130 (P)	318
40	1 1/2	90 (N)	322
		130 (P)	359
50	2	90 (N)	337
		130 (P)	375
65	2 1/2	130 (P)	405

1.) The dimensions for B and H are maximum dimensions and may be up to 6 mm less, depending on the nominal diameter (port connection) and standard.

5.2. Body with threaded connection

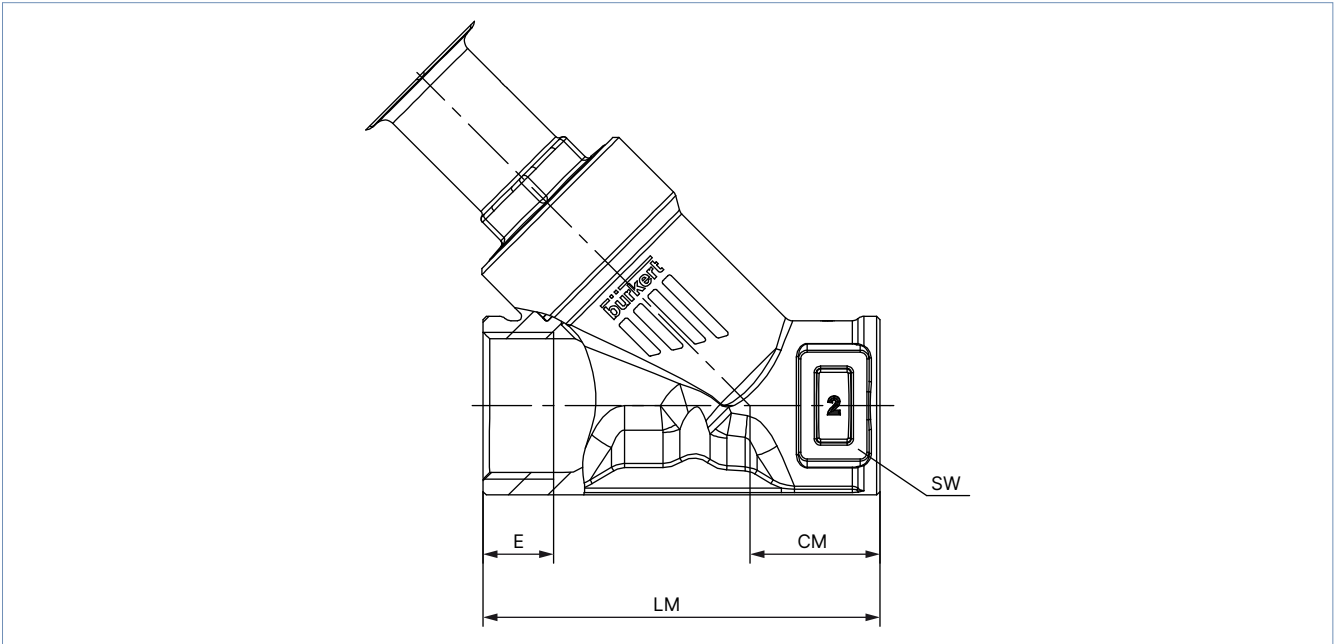

Nominal diameter (port connection)		G (DIN ISO 228-1) NPT (ASME B1.20.1) RC (ISO 7-1)					
		E			CM	LM	SW
DN	NPS	[G]	[NPT]	[RC]			
15	1/2	14	13.7	13.2	24	65	27
20	3/4	16	14.0	14.5	27	75	34
25	1	18	16.8	16.8	29.5	90	41
32	1 1/4	16	17.3	19.1	36	110	50
40	1 1/2	18	17.3	19.1	35	120	55
50	2	24	17.6	23.4	45	150	70
65	2 1/2	26	23.7	26.7	57	185	85

DTS 1000475061 EN Version: J Status: RL (released | freigegeben | validé) printed: 20.02.2025

5.3. Body with welded connection

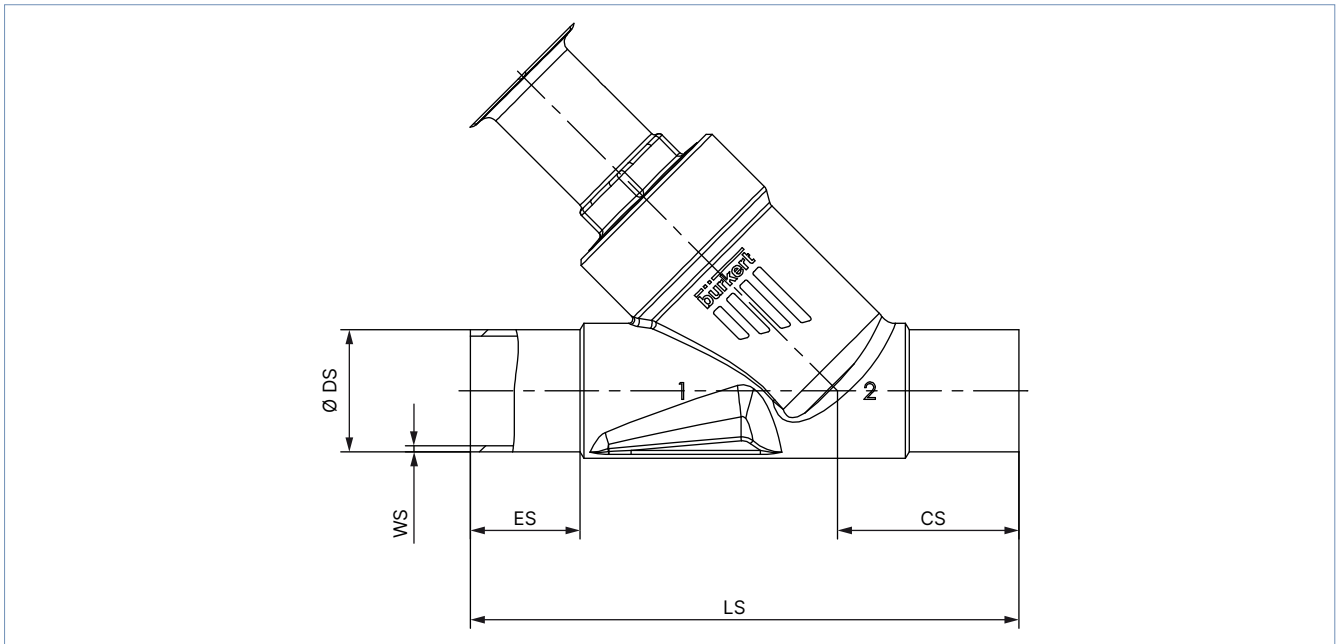

Nominal diameter (port connection)	DIN EN ISO 1127 / ISO 4200 / DIN 11866 series B					DIN 11850 - 2 / DIN 11866 series A				
	ES	CS	LS	Ø DS	WS	ES	CS	LS	Ø DS	WS
15	19	34	100	21.3	1.6	19	34	100	19	1.5
20	20	39	115	26.9	1.6	20	39	115	23	1.5
25	26	43	130	33.7	2.0	26	43	130	29	1.5
32	26	45	145	42.4	2.0	26	45	145	35	1.5
40	26	49	160	48.3	2.0	26	49	160	41	1.5
50	26	50	175	60.3	2.0	26	50	175	53	1.5
65	26	50	210	76.1	2.3	26	50	210	70	2

Nominal diameter (port connection)	ASME BPE / DIN 11866 series C				
NPS	ES	CS	LS	Ø DS	WS
½	30	46	135	12.7	1.65
¾	30	52	145	19.05	1.65
1	30	51	152	25.4	1.65
1½	30	60	182	38.1	1.65
2	30	64	210	50.8	1.65
2½	26	56	230	63.5	1.65

DTS 1000475061 EN Version: J Status: RL (released | freigegeben | validé) printed: 20.02.2025

5.4. Body with clamp connection

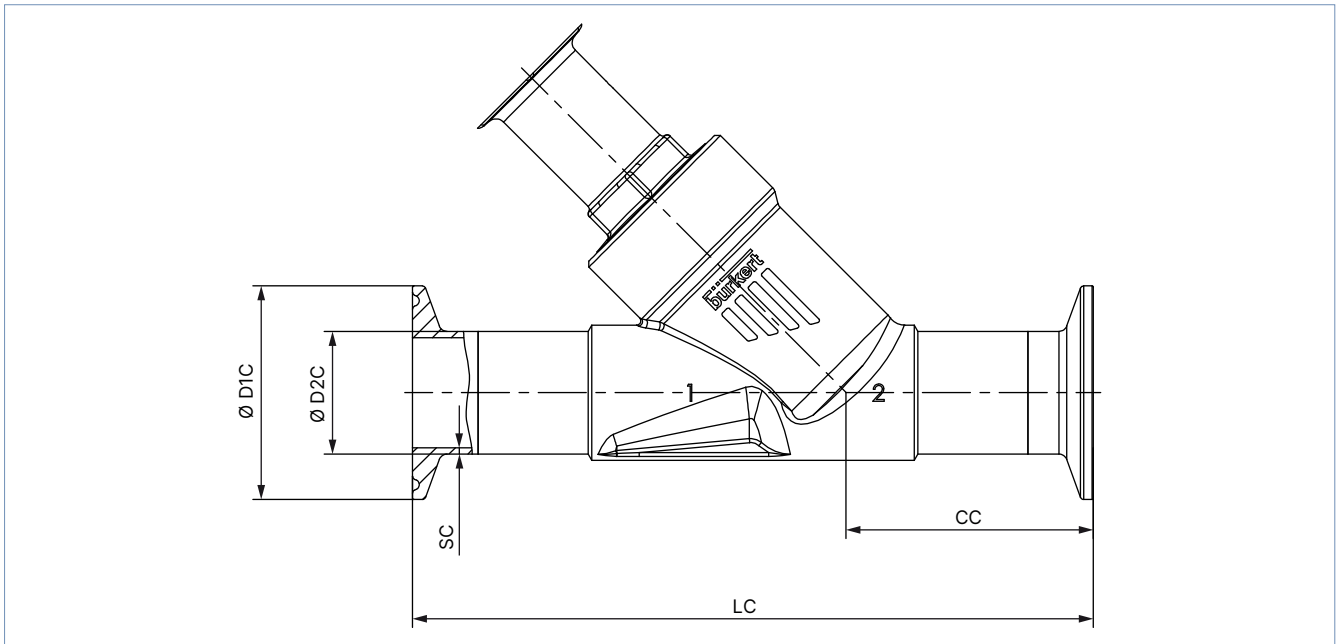

Nominal diameter (port connection)	Clamp: DIN 32676 series B Pipe: DIN EN ISO 1127 / ISO 4200 / DIN 11866 series B					Clamp: DIN 32676 series A Pipe: DIN 11850 - 2 / DIN 11866 series A				
	DN	LC	CC	Ø D1 C	Ø D2 C	SC	LC	CC	Ø D1 C	Ø D2 C
15	156	49.0	50.5	21.3	1.6	130	49.5	34.0	19	1.5
20	150	56.5	50.5	26.9	1.6	150	57.0	34.0	23	1.5
25	160	58.0	50.5	33.7	2.0	160	58.5	50.5	29	1.5
32	200	57.5	50.5	42.4	2.0	180	58.0	50.5	35	1.5
40	200	69.0	64.0	48.3	2.0	200	69.5	50.5	41	1.5
50	230	77.5	77.5	60.3	2.6	230	78.0	64.0	53	1.5

Nominal diameter (port connection)	Clamp: ASME BPE Pipe: ASME BPE / DIN 11866 series C					
	NPS	LC	CC	Ø D1 C	Ø D2 C	SC
½	130	49.0	25.0	12.7	1.65	
¾	150	56.5	25.0	19.05	1.65	
1	160	58.0	50.5	25.4	1.65	
1½	200	69.0	50.5	38.1	1.65	
2	230	77.5	64.0	50.8	1.65	

DTS 1000475061 EN Version: J Status: RL (released | freigegeben | validé) printed: 20.02.2025

## 6. Performance specifications

### 6.1. Fluidic data

#### Flow characteristics

**Note:**

- Modified equal percentage flow characteristic.
- Higher flow values compared to globe control valves

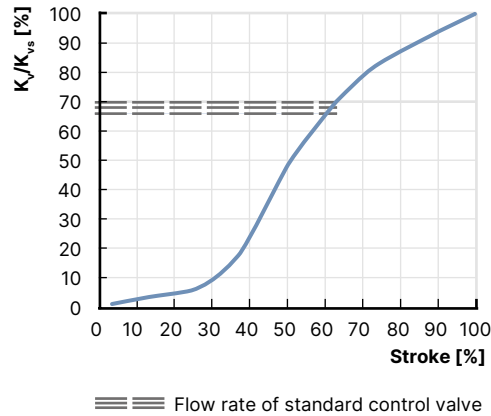

#### Overview of fluidic data for flow below seat (for liquids, steam and gases)

**Note:**

- $K_v$  value [m³/h]: measurement with water according to DIN EN 60534 - 2 - 4
- Operating limits (see "6.2. Operating limits" on page 15)

Nominal diameter (port connection)		Actuator size Ø	Operating pressure max. CF A (seat leakage class)			$K_v$ value at stroke [m³/h]											$K_{vs}$ value
DN	NPS		Seat seal			5%	10%	20%	30%	40%	50%	60%	70%	80%	90%		
		[mm]	Stainless steel	PTFE	PEEK	[m³/h]											[m³/h]
<b>ASME BPE (12.7 mm x 1.65 mm / 0.5" x 0.065")</b>																	
15	½	50 (D)	16 (IV)	16 (VI)	10 (VI)	0.22	0.24	0.30	0.56	1.2	1.5	1.6	1.6	1.6	1.6	1.6	
		70 (M)	25 (IV)	25 (VI)	25 (VI)												
<b>Alle Normen</b>																	
15	½	50 (D)	16 (IV)	16 (VI)	10 (VI)	0.16	0.17	0.22	0.40	1.2	2.7	3.5	4.0	4.5	4.8	5.0	
		70 (M)	25 (IV)	25 (VI)	25 (VI)												
20	¾	70 (M)	25 (IV)	25 (VI)	10 (VI)	0.26	0.27	0.40	1.1	4.0	5.9	7.2	8.3	9.1	9.6	10.0	
		90 (N)	25 (IV)	25 (VI)	25 (VI)												
25	1	70 (M)	12 (IV)	12 (VI)	7 (VI)	0.34	0.36	0.62	1.5	5.2	8.9	11.5	13.0	14.2	15.4	16.0	
		90 (N)	25 (IV)	25 (VI)	20 (VI)												
32	1¼	70 (M)	6 (III)	6 (VI)	–	0.43	0.52	0.82	1.4	4.0	9.3	13.8	16.4	19.2	21.5	23.0	
		90 (N)	16 (IV)	16 (VI)	10 (VI)												
		130 (P)	25 (IV)	25 (VI)	20 (VI)												
40	1½	90 (N)	12 (III)	12 (VI)	7 (VI)	0.47	0.62	1.1	2.6	10.0	17.0	21.5	25.5	29.0	31.5	34.0	
		130 (P)	25 (IV)	25 (VI)	20 (VI)	0.48	0.66	1.4	5.1	14.0	20.0	24.5	28.5	31.5	34.5	36.0	
50	2	90 (N)	7 (III)	7 (VI)	–	0.85	1.1	1.6	2.7	10.2	20.0	28.5	35.5	40.5	45.0	49.0	
		130 (P)	25 (20 <sup>1)</sup> ) (IV)	25 (20 <sup>1)</sup> ) (VI)	20 (VI)	0.87	1.2	1.8	4.0	15.2	26.0	35.0	40.5	45.0	48.0	53	
65	2½	130 (P)	16 (15 <sup>1)</sup> ) (IV)	16 (15 <sup>1)</sup> ) (VI)	10 (VI)	1.7	2.0	6.5	20.0	35.0	48.0	58	67	75	83	90	

1.) According to pressure equipment directive 97/23/EC for compressible fluids of group 1 (dangerous gases and vapours) according to article 3, number 1.3, letter a, first indent)

**Pilot pressure diagram with flow direction below seat (control function B)**

**Actuator size Ø 50 mm**

Maximum control pressure 7 bar(g)

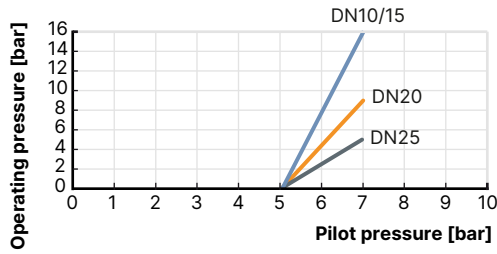

**Actuator size Ø 70 mm**

Maximum control pressure 7 bar(g)

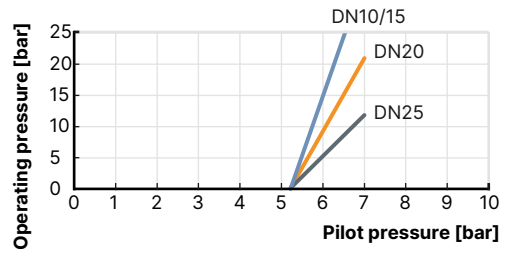

**Actuator size Ø 90 mm**

Maximum control pressure 7 bar(g)

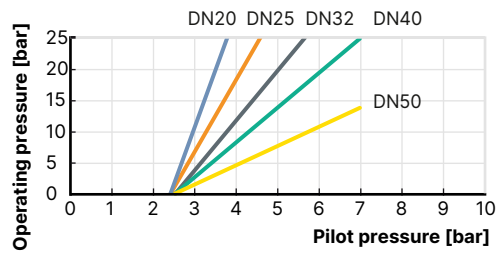

**Actuator size Ø 130 mm**

Maximum control pressure 7 bar(g)

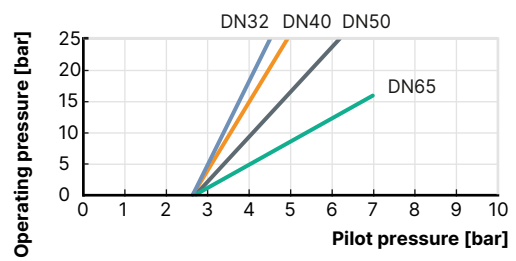

DTS 1000475061 EN Version: J Status: RL (released | freigegeben | validé) printed: 20.02.2025

## 6.2. Operating limits

### Operating limits for medium temperature and operating pressure

The operating range of Bürkert process valves is in addition to the maximum operating pressures limited by the nominal pressure according to the relevant standard.

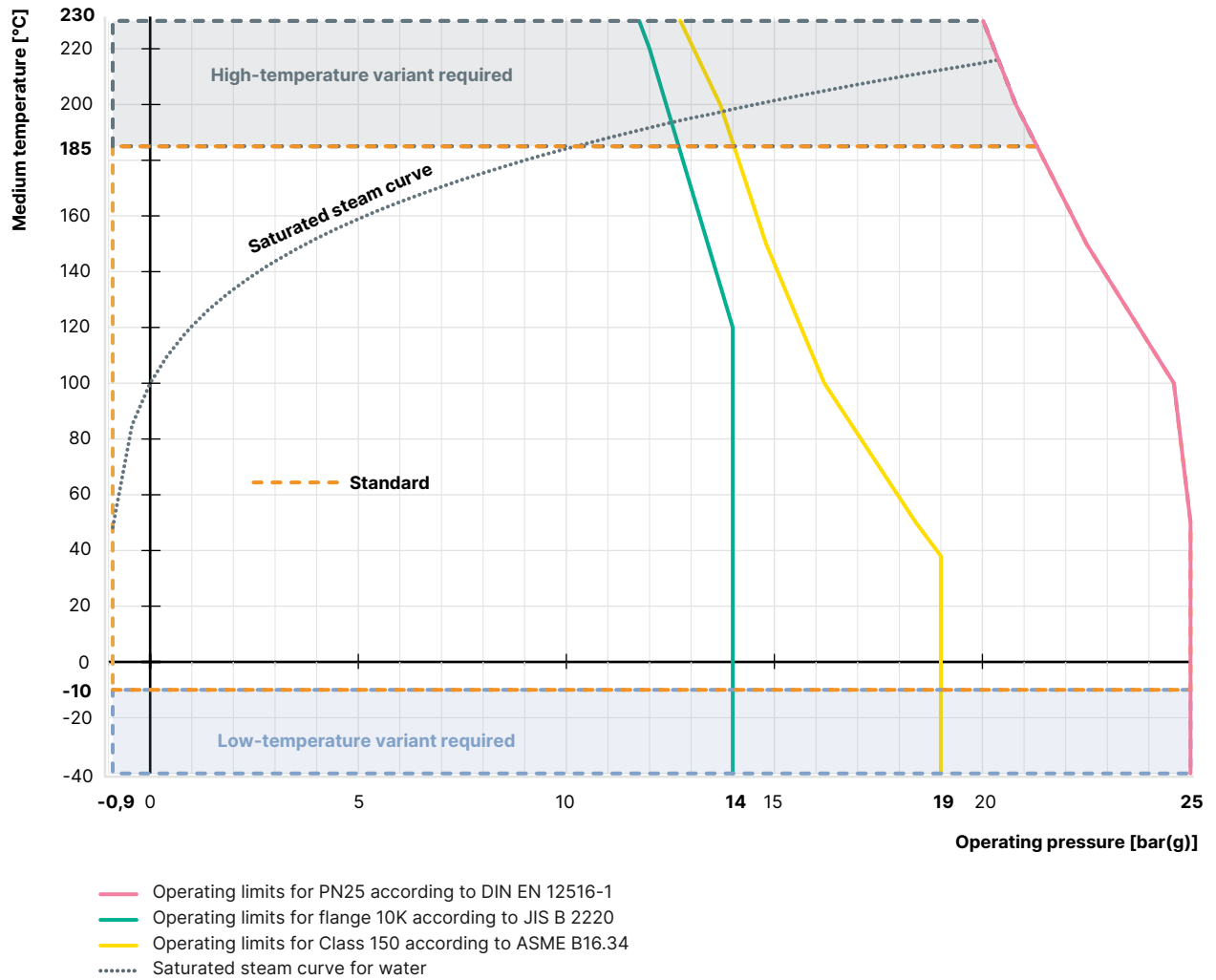

**Operating limits for ambient and medium temperature**

**ELEMENT Actuator**

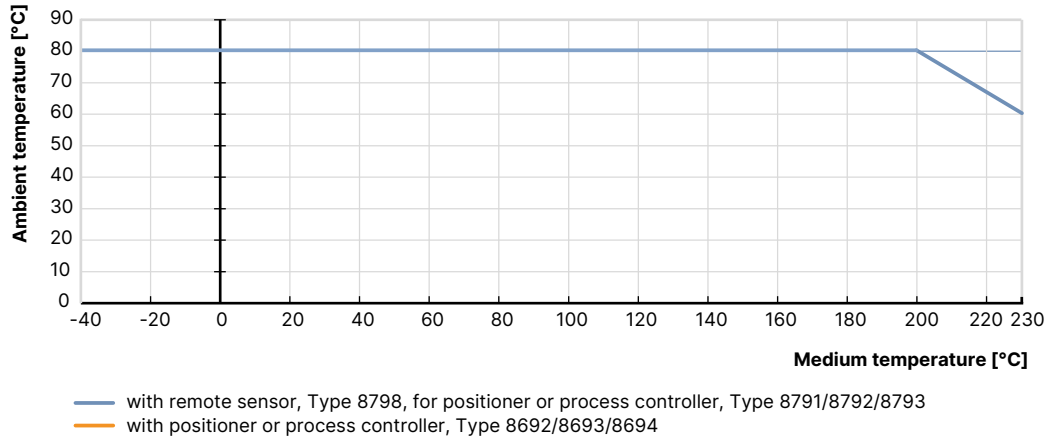

**Operating limits for seat seal**

Tight sealing required	Leakage class (DIN EN 60534 - 4)	Medium temperature	Seat seal
No An additional shut-off valve is recommended	III/IV (metal seals)  Metal-sealed valves have larger leakages (0.1% or 0.01% of the nominal flow rate are permissible).  Metallic seals are impervious even under demanding process conditions.	- 40...+ 230 °C	Stainless steel
Yes An additional shut-off valve is often unnecessary.	VI (soft seals)  By using plastics as sealing material, the control valves can close tightly.  Their use is not recommended in cases of increased erosion due to demanding process conditions.	- 40...+ 130 °C (recommended for ≤ + 130 °C) - 10...+ 230 °C (recommended for > + 130 °C)	PTFE PEEK

DTS 1000475061 EN Version: J Status: RL (released | freigegeben | validé) printed: 20.02.2025



### Operating limits for optional versions

#### High-temperature version

Thanks to an adaption of the spindle seal, this version is suitable for applications with steam, neutral gases and other heat transfer mediums up to + 230 °C.

#### Water version

For applications with water up to + 200 °C, a special configuration of the spindle seal increases service life significantly. It is recommended for water temperatures starting at + 85 °C.

#### Drinking water version

Wetted materials are tested in contact with the medium are tested for suitability with drinking water up to + 85 °C.

#### Vacuum version

Without leakage bore, this design is suitable for pressures down to - 0.9 bar(g).

#### Low-temperature version

Suitable for minimum medium temperatures down to - 40 °C

#### Version for oxygen

Non-metallic wetted materials are tested for suitability with oxygen and are suitable for operating pressures up to 25 bar(g) and medium temperatures up to + 60 °C.

## 7. Product accessories

### Process controller TopControl

#### Type 8693 ▶ Actuator size Ø 70/90/130 mm



The intelligent process controller Type 8693 is designed for integrated mounting on pneumatic actuators from the process control valve series Type 23xx/2103 and especially for the requirements of hygienic process conditions. Using the TUNE functions, the positioner and process controller can be initialised automatically. Easy operation and selection of additional software functions as well as parameterisation are carried out via the large graphic display and a touch keypad. Device configuration and parameterisation can also be conveniently carried out by the Bürkert Communicator software via a PC interface.

#### Features

- Contactless position sensor
- Universal control system for single and double acting actuators
- Highly dynamic actuating system without internal control air consumption in the balanced state
- Integrated diagnostic functions for valve monitoring
- Automatic initialisation of the positioner and process controller using the TUNE function
- Safeguarding in the event of failure of the electrical or pneumatic auxiliary power
- PROFIBUS DPV1, EtherNet/IP, PROFINET, Modbus TCP, Bürkert system bus (bÜS)
- Compact and robust hygienic stainless steel design

#### Customer benefits

- Quick and easy commissioning
- Intuitive and simple operation via a graphic display with backlight and touch keypad
- High system availability due to increased drive service life by means of spring chamber ventilation
- Guaranteed reliability and predictable maintenance through valve monitoring and diagnostics
- Easy maintenance and process monitoring

**Positioner TopControl**

**Type 8692 ▶ Actuator size Ø 70/90/130 mm**



The intelligent electropneumatic positioner Type 8692 is designed for integrated attachment to pneumatic actuators of the process control valve series Type 23xx/2103 and especially for the requirements of hygienic process conditions. The positioner can be initialised automatically using the TUNE function. Easy operation and the selection of the extensive additional software functions as well as parameterisation are carried out via the large graphic display and the touch keypad. The device configuration and parameterisation can also be conveniently carried out using the Bürkert Communicator software via a PC interface.

**Features**

- Contactless position sensor
- Universal positioning system for single and double-acting actuators in the balanced state
- Highly dynamic positioning system without internal control air consumption
- Integrated diagnostic functions for valve monitoring
- Automatic initialisation of the positioner by using the TUNE function
- Safeguard in the event of failure of the electrical or pneumatic auxiliary power
- PROFIBUS DPV1, EtherNet/IP, PROFINET, Modbus TCP, Bürkert system bus (bÜS)
- Compact and robust hygienic stainless steel design

**Customer benefits**

- Quick and easy commissioning
- Intuitive and simple operation via graphic display with backlight and touch keypad
- High system availability due to increased drive service life by means of spring chamber ventilation
- Guaranteed reliability and predictable maintenance through valve monitoring and diagnostics

**Positioner TopControl BASIC**

**Type 8694 ▶ Actuator size Ø 70/90/130 mm**



The compact positioner Type 8694/8696 is designed for integrated attachment to pneumatic actuators of the Type 23xx/2103 process control valve series and especially for the requirements of hygienic process conditions. Operation and parameterisation are performed via push buttons and DIP switches. The device configuration and parameterisation can also be conveniently carried out using the Bürkert Communicator software via a PC interface.

**Features**

- Contactless position sensor
- Universal positioning system for single and double-acting actuators
- Ultra dynamic positioning system without internal control air consumption
- AS-Interface, IO-Link, Bürkert system bus (bÜS) (only 8694)
- Compact and robust hygienic stainless steel design

**Type 8696 ▶ Actuator size Ø 50 mm**



**Customer benefits**

- Simple and safe commissioning using the teach function
- Minimum space requirement in the plant pipework for more flexibility in plant design
- High system availability due to increased drive service life by means of spring chamber ventilation

DTS 1000475061 EN Version: J Status: RL (released | freigegeben | validé) printed: 20.02.2025

**Process controller SideControl Remote**
**Type 8793 ▶ with remote sensor 8798 ▶ Actuator size Ø 70/90/130 mm**

The intelligent digital positioner and process controller Type 8793 is designed for mounting on lift or swivel drives with standardisation in accordance with IEC 534 - 6 or VDI/VDE 3845 for demanding control tasks. The variant with remote position sensor Type 8798 is used to control Bürkert process control valves. It is operated via a graphic display with backlight. The initialisation of the positioner and process controller can be done automatically using the TUNE function. The type of controlled system is automatically recognised and the appropriate controller structure with the corresponding optimum parameter set is determined.

**Features**

- Universal control system for single and double acting actuators
- Integrated diagnostic functions for valve monitoring
- Automatic initialisation of the position and process controller using the TUNE function
- Ultra-dynamic actuating system without internal control air consumption
- Illuminated graphic display with backlight and touch keypad
- PROFIBUS DPV1, EtherNet/IP, PROFINET, Modbus TCP, Bürkert system bus (bÜS)
- Compact and robust design
- Adaptation according to IEC 534 - 6 or VDI/VDE 3845 for lift and swivel drives or as remote variant on Bürkert process valves

**Customer benefits**

- Quick and easy commissioning
- Intuitive and simple operation via graphic display with backlight and touch keypad
- Guaranteed reliability and scheduled maintenance thanks to valve monitoring and diagnostics
- Easy maintenance and process monitoring
- Long service life

**Positioner SideControl Remote**
**Positioner Type 8792 ▶ with remote sensor Type 8798 ▶ Actuator size Ø 70/90/130 mm**

The intelligent digital positioner and process controller Type 8792 is designed for attachment to lift and swivel drives with standardisation according to IEC 534 - 6 or VDI/VDE 3845 for demanding control tasks. The Type 8798 version with remote position sensor is used to control Bürkert process control valves. It is operated via a graphic display with backlight. The initialisation of the positioner and process controller can be done automatically by using the TUNE function.

**Features**

- Illuminated graphic display with backlight and touch keypad
- Universal control system for single and double acting actuators
- Ultra-dynamic actuating system without internal control air consumption
- Integrated diagnostic functions for valve monitoring
- PROFIBUS DPV1, EtherNet/IP, PROFINET, Modbus TCP, Bürkert system bus (bÜS)
- Compact and robust design
- Adaptation according to IEC 534 - 6 or VDI/VDE 3845 for lift and swivel drives or as remote variant on Bürkert process valves

**Customer benefits**

- Quick and easy commissioning
- Intuitive and simple operation via a graphic display with backlight and touch keypad
- Guaranteed reliability and scheduled maintenance thanks to valve monitoring and diagnostics
- Long service life

**Positioner SideControl BASIC Remote**

**Positioner Type 8791 ▶ with remote sensor Type 8798 ▶ Actuator size Ø 70/90/130 mm**



The intelligent digital positioner and process controller Type 8791/8798 is designed for mounting on linear and rotary actuators with standardisation in accordance with IEC 534 - 6 or VDI/VDE 3845 for demanding control tasks. The variant with remote position sensor Type 8798 is used for controlling Bürkert process control valves. It is operated via a graphic display with backlight. The positioner and process controller can be initialised automatically using the TUNE functions.

**Features**

- Simple design
- Universal control system for single and double acting actuators
- Highly dynamic actuating system without internal control air consumption in the balanced state
- Adaptation according to IEC 534 - 6 or VDI/VDE 3845 for lift and swivel drives or as remote variant on Bürkert process valves
- AS-Interface, IO-Link, Bürkert system bus (bÜS) (only for positioner Type 8791 BASIC Remote)

**Positioner IP20 Type 8791 ▶ with remote sensor Type 8798 ▶ Actuator size Ø 70/90/130 mm**



**Customer benefits**

- Simple commissioning
- Simple device for simple control tasks
- Low energy consumption

DTS 1000475061 EN Version: J Status: RL (released | freigegeben | validé) printed: 20.02.2025

## 8. Networking and combination with other Bürkert products

The **angle seat valve Type 2300** can be combined with the **process controller Type 8693** or the positioner controller **Type 8692/8694** to form the **Continuous ELEMENT valve system Type 8802-YG**.

**Note:**

- Use the **Product Enquiry Form** for the configuration of other valve systems (see **"9.3. Bürkert Product Enquiry Form" on page 23**).
- You order two components and receive a completely assembled and tested valve.

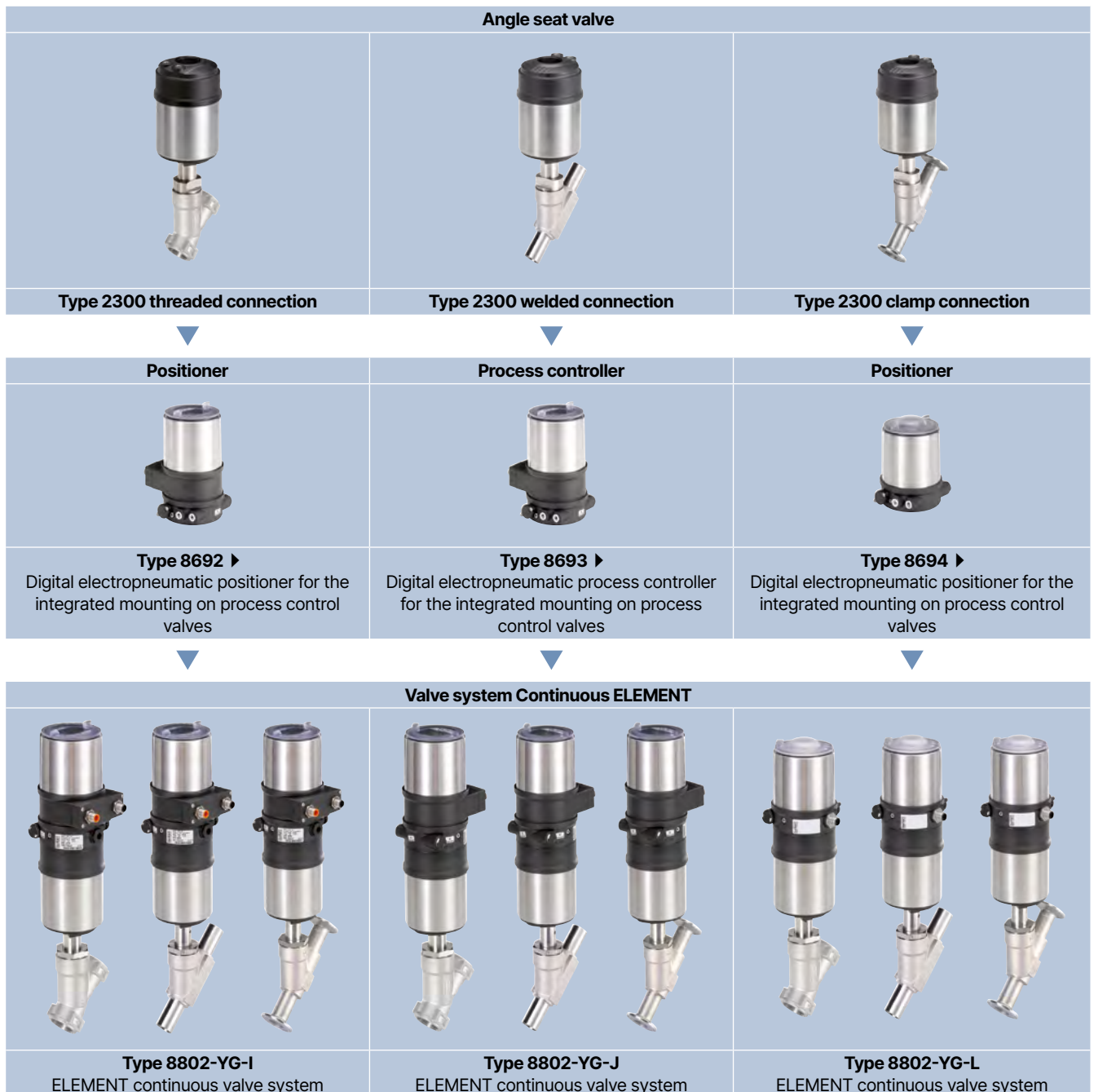

DTS 1000475061 EN Version: J Status: RL (released | freigegeben | validé) printed: 20.02.2025

The **angle seat valve Type 2300** can be combined with the **process controller Type 8793**, the **positioner Type 8792** or the **TopControl Basic Type 8696** to form the **Continuous ELEMENT valve system Type 8802-YG**.

**Note:**

- Use the **Product Enquiry Form** for the configuration of other valve systems (see **"9.3. Bürkert Product Enquiry Form" on page 23**).
- You order two components and receive a completely assembled and tested valve.

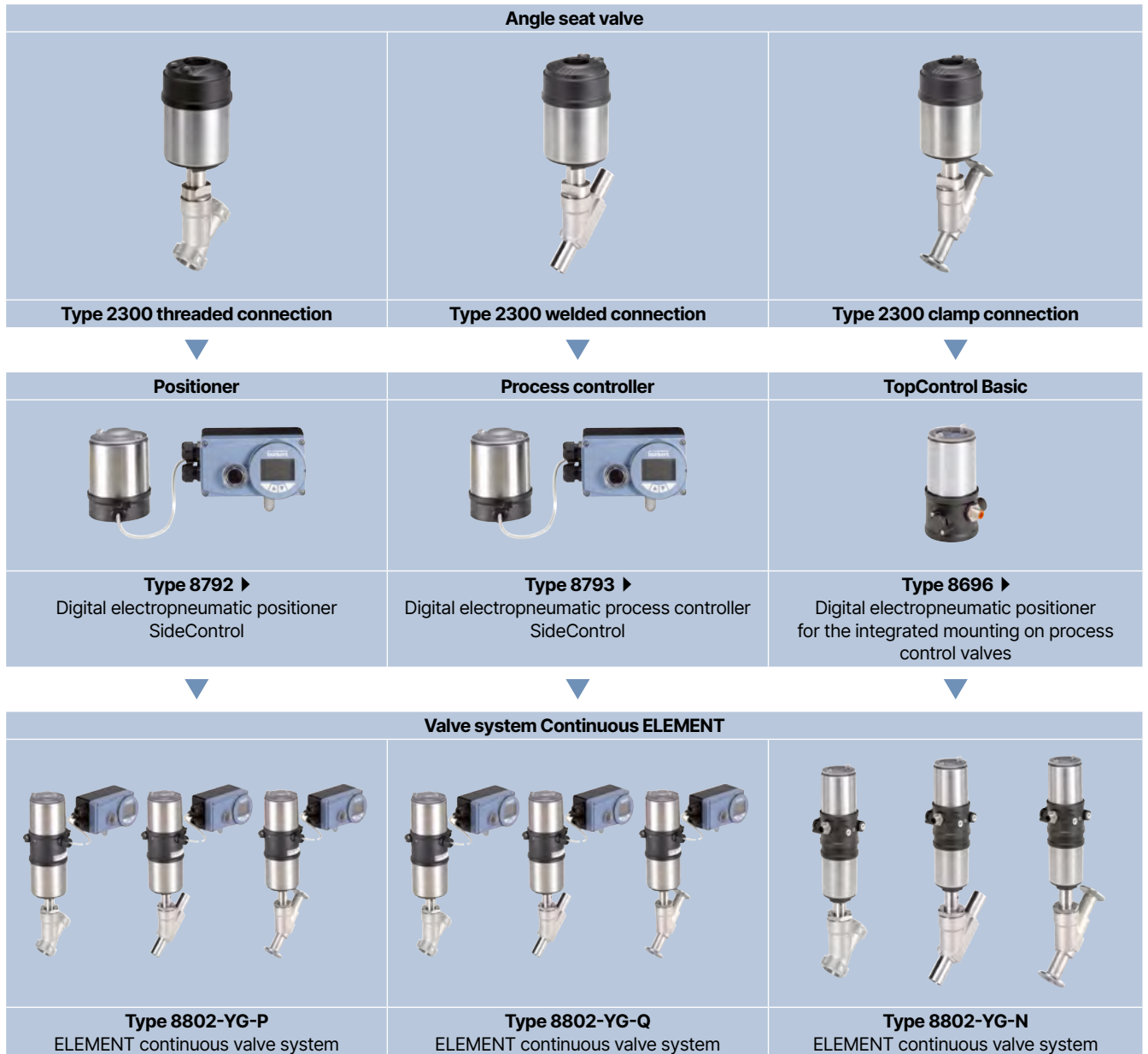

DTS 1000475061 EN Version: J Status: RL (released | freigegeben | valide) printed: 20.02.2025

## 9. Ordering information

### 9.1. Bürkert eShop



#### Bürkert eShop – Easy ordering and quick delivery

You want to find your desired Bürkert product or spare part quickly and order directly? Our online shop is available for you 24/7. Sign up and enjoy all the benefits.

[Order online now](#)

### 9.2. Bürkert product filter



#### Bürkert product filter – Get quickly to the right product

You want to select products comfortably based on your technical requirements? Use the Bürkert product filter and find suitable articles for your application quickly and easily.

[Try out our product filter](#)

### 9.3. Bürkert Product Enquiry Form

**Note:**

Please see our Product Enquiry Form for a full explanation of our specification key.

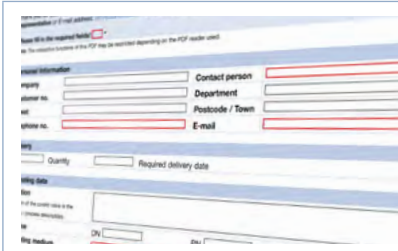

#### Bürkert Product Enquiry Form – Your enquiry quickly and compactly

Would you like to make a specific product enquiry based on your technical requirements? Use our Product Enquiry Form for this purpose. There you will find all the relevant information for your Bürkert contact. This will enable us to provide you with the best possible advice.

















































































[Fill out the form now](#)

DTS 1000475061 EN Version: J Status: RL (released | freigegeben | valide) printed: 20.02.2025



## 9.4. Ordering chart threaded connection

### Valves with flow direction below seat









































Control function	Nominal diameter (port connection)	Port connection thread	Actuator size Ø	K <sub>vs</sub> value water	Operating pressure max. +185 °C	Article no. Seat seal	Leakage class	Article no. Seat seal	Leakage class
	DN	[inch]	[mm]	[m <sup>3</sup> /h]	[bar(g)]	PTFE		Stainless steel	
<b>G thread</b>									
<b>A (CF A)</b> see control functions <sup>1)</sup>	15	G ½	50 (D)	5	16	213712 	VI	213763 	IV
		G ½	70 (M)	5	25	213713 	VI	213764 	IV
	20	G ¾	70 (M)	10	25	213715 	VI	213766 	IV
		25	G 1	70 (M)	16	12	213718 	VI	213768 
	G 1		90 (N)	16	25	245405 	VI	229276 	IV
	32	G 1¼	70 (M)	23	6	213719 	VI	213769 	III
		G 1¼	90 (N)	23	16	245406 	VI	225395 	IV
	40	G 1½	90 (N)	34	12	213720 	VI	213770 	III
		G 1½	130 (P)	36	25	223307 	VI	223310 	IV
	50	G 2	90 (N)	49	7	203500 	VI	206230 	III
G 2		130 (P)	53	25 (20 <sup>2)</sup> )	213697 	VI	213708 	IV	
65	G 2½	130 (P)	90	16 (15 <sup>2)</sup> )	239487 	VI	239503 	IV	
	<b>B (CF B)</b> see control functions <sup>1)</sup>	15	G ½	50 (D)	5	See diagram <sup>3)</sup>	213722 	VI	223313 
G ½			70 (M)	5	213721 		VI	223314 	IV
20		G ¾	70 (M)	10	213724 		VI	223316 	IV
25		G 1	70 (M)	16	213726 		VI	223318 	III
32		G 1¼	70 (M)	23	213727 		VI	223319 	III
40		G 1½	90 (N)	34	213728 		VI	223320 	IV
50		G 2	90 (N)	49	203510 		VI	223321 	III
65		G 2½	130 (P)	90	239495 		VI	239511 	IV
<b>NPT thread</b>									
<b>A (CF A)</b> see control functions <sup>1)</sup>	15	NPT ½	50 (D)	5	16	213729 	VI	213771 	IV
		NPT ½	70 (M)	5	25	213730 	VI	213772 	IV
	20	NPT ¾	70 (M)	10	25	213732 	VI	213774 	IV
		25	NPT 1	70 (M)	16	12	213734 	VI	213776 
	NPT 1		90 (N)	16	25	465032 	VI	464364 	IV
	32	NPT 1¼	70 (M)	23	6	213736 	VI	213777 	III
		NPT 1¼	90 (N)	23	16	465033 	VI	464365 	IV
	40	NPT 1½	90 (N)	34	12	213737 	VI	213778 	III
		NPT 1½	130 (P)	36	25	223308 	VI	223311 	IV
	50	NPT 2	90 (N)	49	7	203537 	VI	206239 	III
NPT 2		130 (P)	53	25 (20 <sup>2)</sup> )	213699 	VI	213709 	IV	
65	NPT 2½	130 (P)	90	16 (15 <sup>2)</sup> )	239488 	VI	239504 	IV	
<b>B (CF B)</b> see control functions <sup>1)</sup>	15	NPT ½	50 (D)	5	See diagram <sup>3)</sup>	213738 	VI	223322 	IV
		NPT ½	70 (M)	5		213739 	VI	223323 	IV
	20	NPT ¾	70 (M)	10		213741 	VI	223325 	IV
	25	NPT 1	70 (M)	16		213743 	VI	223327 	III
	32	NPT 1¼	70 (M)	23		213744 	VI	223328 	III
	40	NPT 1½	90 (N)	34		213745 	VI	223329 	IV
	50	NPT 2	90 (N)	49		203546 	VI	223330 	III
	65	NPT 2½	130 (P)	90		239486 	VI	239512 	IV

1.) Further information can be found in chapter "2. Control functions" on page 4.

2.) According to pressure equipment directive 97/23/EC for compressible fluids of group 1 (dangerous gases and vapours) according to article 3, number 1.3, letter a, first indent)

3.) See diagrams in chapter "Pilot pressure diagram with flow direction below seat (control function B)" on page 14.



Control function	Nominal diameter (port connection)	Port connection thread	Actuator size Ø	K <sub>vs</sub> value water	Operating pressure max. + 185 °C	Article no. Seat seal	Leakage class	Article no. Seat seal	Leakage class
	DN	[inch]	[mm]	[m <sup>3</sup> /h]	[bar(g)]	PTFE		Stainless steel	
<b>RC thread</b>									
<b>A (CF A)</b> see control functions <sup>1)</sup>	15	RC ½	50 (D)	5	16	213746 	VI	213779 	IV
		RC ½	70 (M)	5	25	213747 	VI	213780 	IV
	20	RC ¾	70 (M)	10	25	213749 	VI	213782 	IV
		25	RC 1	70 (M)	16	12	213751 	VI	213784 
	RC 1		90 (N)	16	25	245407 	VI	245438 	IV
	32	RC 1¼	70 (M)	23	6	213752 	VI	213785 	III
		RC 1¼	90 (N)	23	16	245408 	VI	245439 	IV
	40	RC 1½	90 (N)	34	12	213753 	VI	213786 	III
		RC 1½	130 (P)	36	25	223309 	VI	223312 	IV
	50	RC 2	90 (N)	49	7	203555 	VI	206249 	III
RC 2		130 (P)	53	25 (20 <sup>2.)</sup> )	213700 	VI	213710 	IV	
65	RC 2½	130 (P)	90	16 (15 <sup>2.)</sup> )	239489 	VI	239506 	IV	
<b>B (CF B)</b> see control functions <sup>1)</sup>	15	RC ½	50 (D)	5	See diagram <sup>3.)</sup>	213755 	VI	223331 	IV
		RC ½	70 (M)	5		213756 	VI	223332 	IV
	20	RC ¾	70 (M)	10		213758 	VI	223334 	IV
	25	RC 1	70 (M)	16		213760 	VI	223336 	III
	32	RC 1¼	70 (M)	23		213761 	VI	223337 	III
	40	RC 1½	90 (N)	34		213762 	VI	223338 	IV
	50	RC 2	90 (N)	49		203564 	VI	223339 	III
	65	RC 2½	130 (P)	90		239497 	VI	239513 	IV

1.) Further information can be found in chapter "2. Control functions" on page 4.

2.) According to pressure equipment directive 97/23/EC for compressible fluids of group 1 (dangerous gases and vapours) according to article 3, number 1.3, letter a, first indent)

3.) See diagrams in chapter "Pilot pressure diagram with flow direction below seat (control function B)" on page 14.

## 9.5. Ordering chart welded connection

Valves with flow direction below seat

Control function	Nominal diameter (port connection)	Connec-tion Ø DS x WS	Actuator size Ø	K <sub>vs</sub> value water	Operating pressure max. + 185 °C	Article no. Seat seal	Leakage class	Article no. Seat seal	Leakage class		
	DN	[inch]	[mm]	[m <sup>3</sup> /h]	[bar(g)]	PTFE		Stainless steel			
<b>DIN EN ISO 1127</b>											
<b>A (CF A)</b> see control functions <sup>1)</sup>	15	21.3 × 1.6	50 (D)	5	16	203565	VI	206250	IV		
		21.3 × 1.6	70 (M)	5	25	203566	VI	206252	IV		
	20	26.9 × 1.6	70 (M)	10	25	203568	VI	206254	IV		
		25	33.7 × 2	70 (M)	16	12	203570	VI	206256	III	
	33.7 × 2		90 (N)	16	25	245395	VI	245403	IV		
	32	42.4 × 2	70 (M)	23	6	203571	VI	206257	III		
		42.4 × 2	90 (N)	23	16	204766	VI	245404	IV		
	40	48.3 × 2	90 (N)	34	12	203572	VI	206258	III		
		48.3 × 2	130 (P)	36	25	223299	VI	223306	IV		
	50	60.3 × 2.0	90 (N)	49	7	274669	VI	274670	III		
60.3 × 2.0		130 (P)	53	25 (20 <sup>2)</sup> )	274672	VI	274673	IV			
<b>B (CF B)</b> see control functions <sup>1)</sup>	15	21.3 × 1.6	50 (D)	5	See diagram <sup>3)</sup>	203574	VI	223340	IV		
		21.3 × 1.6	70 (M)	5		203575	VI	223341	IV		
	20	26.9 × 1.6	70 (M)	10		203577	VI	223343	IV		
	25	33.7 × 2	70 (M)	16		203579	VI	223345	III		
	32	42.4 × 2	70 (M)	23		203580	VI	223346	III		
	40	48.3 × 2	90 (N)	34		203581	VI	223347	IV		
	50	60.3 × 2.0	90 (N)	49		274674	VI	274675	III		
	65	76.1 × 2.3	130 (P)	90		239498	VI	239515	IV		
	<b>DIN 11850 R2</b>										
	<b>A (CF A)</b> see control functions <sup>1)</sup>	15	19 × 1.5	50 (D)		5	16	203583	VI	223349	IV
19 × 1.5			70 (M)	5	25	203584	VI	223350	IV		
20		23 × 1.5	70 (M)	10	25	203586	VI	223352	IV		
		25	29 × 1.5	70 (M)	16	12	203588	VI	223354	III	
29 × 1.5			90 (N)	16	25	245396	VI	245409	IV		
32		35 × 1.5	70 (M)	23	6	203589	VI	223355	III		
		35 × 1.5	90 (N)	23	16	204767	VI	245410	IV		
40		41 × 1.5	90 (N)	34	12	203590	VI	223356	III		
		41 × 1.5	130 (P)	36	25	223300	VI	223357	IV		
50		53 × 1.5	90 (N)	49	7	203591	VI	223358	III		
	53 × 1.5	130 (P)	53	25 (20 <sup>2)</sup> )	213702	VI	223359	IV			
<b>B (CF B)</b> see control functions <sup>1)</sup>	15	19 × 1.5	50 (D)	5	See diagram <sup>3)</sup>	203592	VI	223360	IV		
		19 × 1.5	70 (M)	5		203593	VI	223361	IV		
	20	23 × 1.5	70 (M)	10		203595	VI	223363	IV		
	25	29 × 1.5	70 (M)	16		203597	VI	223365	III		
	32	35 × 1.5	70 (M)	23		203598	VI	223366	III		
	40	41 × 1.5	90 (N)	34		203599	VI	223367	IV		
	50	53 × 1.5	90 (N)	49		203600	VI	223368	III		
	65	70 × 2	130 (P)	90		239499	VI	239516	IV		

1.) Further information can be found in chapter "2. Control functions" on page 4.

2.) According to pressure equipment directive 97/23/EC for compressible fluids of group 1 (dangerous gases and vapours) according to article 3, number 1.3, letter a, first indent)

3.) See diagrams in chapter "Pilot pressure diagram with flow direction below seat (control function B)" on page 14.

Control function	Nominal diameter (port connection)	Connection Ø DS x WS	Actuator size Ø	K <sub>vs</sub> value water	Operating pressure max. + 185 °C	Article no. Seat seal	Leakage class	Article no. Seat seal	Leakage class
	DN [inch]	[inch]	[mm]	[m <sup>3</sup> /h]	[bar(g)]	PTFE		Stainless steel	
<b>ASME BPE</b>									
<b>A (CF A)</b> see control functions <sup>1)</sup>	½	12.7 × 1.65	50 (D)	1.6	16	203601	VI	223369	IV
		12.7 × 1.65	70 (M)	1.6	25	203602	VI	223370	IV
	¾	19.05 × 1.65	70 (M)	10	25	203604	VI	223372	IV
		25.4 × 1.65	70 (M)	16	12	203606	VI	223374	III
	1	25.4 × 1.65	90 (N)	16	25	245397	VI	464366	IV
		38.1 × 1.65	90 (N)	34	12	203607	VI	212906	III
	1½	38.1 × 1.65	130 (P)	36	25	223303	VI	223376	IV
		50.8 × 1.65	90 (N)	49	7	203608	VI	223377	III
	2	50.8 × 1.65	130 (P)	53	25 (20 <sup>2.)</sup> )	213703	VI	223378	IV
		63.5 × 1.65	130 (P)	90	16 (15 <sup>2.)</sup> )	239492	VI	239508	IV
<b>B (CF B)</b> see control functions <sup>1)</sup>	½	12.7 × 1.65	50 (D)	1.6	See diagram <sup>3.)</sup>	203609	VI	223379	IV
		12.7 × 1.65	70 (M)	1.6		203610	VI	223380	IV
	¾	19.05 × 1.65	70 (M)	10		203612	VI	223382	IV
		25.4 × 1.65	70 (M)	16		203614	VI	223384	III
	1½	38.1 × 1.65	90 (N)	34		203615	VI	223385	IV
	2	50.8 × 1.65	90 (N)	49		203616	VI	223386	III
	2½	63.5 × 1.65	130 (P)	90		239500	VI	239517	IV

1.) Further information can be found in chapter "2. Control functions" on page 4.





























































2.) According to pressure equipment directive 97/23/EC for compressible fluids of group 1 (dangerous gases and vapours) according to article 3, number 1.3, letter a, first indent)

3.) See diagrams in chapter "Pilot pressure diagram with flow direction below seat (control function B)" on page 14.

DTS 1000475061 EN Version: J Status: RL (released | freigegeben | validé) printed: 20.02.2025

## 9.6. Ordering chart clamp connection

### Valves with flow direction below seat

Control function	Nominal diameter (port connection)	Connection Ø D1 C x SC, Ø D2 C	Actuator size Ø	K <sub>vs</sub> value water	Operating pressure max. + 185 °C	Article no. Seat seal	Leakage class	Article no. Seat seal	Leakage class
	DN	[inch]	[mm]	[m <sup>3</sup> /h]	[bar(g)]	PTFE		Stainless steel	
<b>ISO 2852</b>									
<b>A (CF A)</b> see control functions <sup>1)</sup>	15	21.3 × 1.6. 50.5	50 (D)	5	16	o. r.	VI	o. r.	IV
		21.3 × 1.6. 50.5	70 (M)	5	25	20010520 	VI	378088 	IV
	20	26.9 × 1.6. 50.5	70 (M)	10	25	203652 	VI	223426 	IV
		25	33.7 × 2.0. 50.5	70 (M)	16	12	203654 	VI	223428 
	32		33.7 × 2.0. 50.5	90 (N)	16	25	245401 	VI	245414 
		40	42.4 × 2.0. 50.5	70 (M)	23	6	203655 	VI	223429 
	50		42.4 × 2.0. 50.5	90 (N)	23	16	204768 	VI	245415 
		40	48.3 × 2.0. 64.0	90 (N)	34	12	203656 	VI	223430 
	50		48.3 × 2.0. 64.0	130 (P)	36	25	223304 	VI	223431 
		50	60.3 × 2.6. 77.5	90 (N)	49	7	203657 	VI	223433 
50	60.3 × 2.6. 77.5		130 (P)	53	25 (20 <sup>2)</sup> )	213706 	VI	223434 	IV
	<b>B (CF B)</b> see control functions <sup>1)</sup>	15	21.3 × 1.6. 50.5	50 (D)	5	See diagram <sup>2)</sup>	o. r.	VI	o. r.
21.3 × 1.6. 50.5			70 (M)	5	o. r.		VI	o. r.	IV
20		26.9 × 1.6. 50.5	70 (M)	10	203661 		VI	223438 	IV
25		33.7 × 2.0. 50.5	70 (M)	16	203663 		VI	223440 	III
32		42.4 × 2.0. 50.5	70 (M)	23	203664 		VI	223441 	III
40		48.3 × 2.0. 64.0	90 (N)	34	203665 		VI	223442 	IV
50		60.3 × 2.6. 77.5	90 (N)	49	203666 		VI	223443 	III
<b>ASME BPE</b>									
<b>A (CF A)</b> see control functions <sup>1)</sup>	½	12.7 × 1.65. 25.0	50 (D)	1.6	16	203667 	VI	223444 	IV
		12.7 × 1.65. 25.0	70 (M)	1.6	25	203668 	VI	223445 	IV
	¾	19.05 × 1.65. 25.0	70 (M)	10	25	203670 	VI	223447 	IV
		1	25.4 × 1.65. 50.5	70 (M)	16	12	203672 	VI	223449 
	1½		25.4 × 1.65. 50.5	90 (N)	16	25	245402 	VI	245416 
		2	38.1 × 1.65. 50.5	90 (N)	34	12	203673 	VI	223450 
	2		38.1 × 1.65. 50.5	130 (P)	36	25	223305 	VI	223451 
		2	50.8 × 1.65. 64.0	90 (N)	49	7	203674 	VI	223452 
2	50.8 × 1.65. 64.0		130 (P)	53	25 (20 <sup>2)</sup> )	213707 	VI	223453 	IV
	<b>B (CF B)</b> see control functions <sup>1)</sup>	½	12.7 × 1.65. 25.0	50 (D)	1.6	See diagram <sup>2)</sup>	203675 	VI	223454 
12.7 × 1.65. 25.0			70 (M)	1.6	203677 		VI	223455 	IV
¾		19.05 × 1.65. 25.0	70 (M)	10	203679 		VI	223457 	IV
1		25.4 × 1.65. 50.5	70 (M)	16	203681 		VI	223459 	III
1½		38.1 × 1.65. 50.5	90 (N)	34	203682 		VI	223460 	IV
2		50.8 × 1.65. 64.0	90 (N)	49	203683 		VI	223461 	III

o. r. = on request

1.) Further information can be found in chapter "2. Control functions" on page 4.

2.) See diagrams in chapter "Pilot pressure diagram with flow direction below seat (control function B)" on page 14.

### Further versions on request



#### Process connection

Clamp according to DIN 32676, BS4825



#### Circuit function

B (normally open) and I (double-acting)