



Pneumatic rotary actuator for the automation of ball and butterfly valves

- Combination with top control positioner Type 8691/8692/8693/8694 possible
- Ideally suited for hygienic applications
- 100 % maintenance-free (welded stainless steel housing)
- Streamline design
- Standardised interface according to ISO 5211

Product variants described in the data sheet may differ from the product presentation and description.

Can be combined with

	Type 2654 2/2-way ball valve, 3-piece	▶
	Type 2651 2/2-way or 3/2-way ball valve, 2-piece	▶
	Type 2657 Ball valve, manually operated	▶
	Type 8691 Control head for decentralised automation of ELEMENT process valves	▶
	Type 8692 Digital electropneumatic positioner for integrated mounting on process control valves	▶
	Type 8693 Digital electropneumatic process controller for integrated mounting on process control valves	▶

Type description

The pneumatic actuator Type 2053 enables the automated actuation of ball and butterfly valves. The linear stroke movement of the actuator piston is deflected into a 90° rotary movement of the actuator stem. The interface on the armature is designed according to ISO 5211. In addition, the rotary actuator can be combined with the 8691/2/3/4 series position feedback sensors. The single-acting actuators are returned to the initial position by spring force, while double-acting actuators are returned by compressed air. The welded construction of the stainless steel housing ensures the actuator is 100% maintenance-free. Overall, the actuator is available in three different sizes: P0 - P1 - P2. All three sizes have an extremely high torque in the closing area despite their compact design. The air consumption per stroke cycle is very low due to the low cylinder volume. This offers a remarkable energy saving potential.

DTS 1000436877 EN Version: E Status: RL (released | freigegeben | valide) printed: 22.01.2026

Table of contents

1. General technical data	3
2. Approvals and conformities	3
2.1. General notes	3
2.2. Conformity	3
2.3. Standards	3
3. Control functions	4
4. Materials	4
4.1. Bürkert resistApp	4
4.2. Material specifications	4
Central section	4
Interface for ELEMENT control heads and positioners	5
Cover	5
Bottom plate	5
5. Dimensions	6
5.1. Variant P0	6
5.2. Variant P1	7
5.3. Variant P2	8
6. Performance specifications	9
6.1. Torque chart	9
Single-acting	9
Double-acting	9
6.2. Air consumption	9
7. Product operation	9
7.1. Functional overview	9
8. Networking and combination with other Bürkert products	10
9. Ordering information	11
9.1. Bürkert eShop	11
9.2. Bürkert product filter	11
9.3. Ordering chart	11
Double-acting, control head/positioner ready	11
Double-acting	11
Single-acting, control head/positioner ready	12
Single-acting	12
9.4. Ordering chart accessories	12
Form seal for control units of Type 8691/8692/8693/8694	12
Angled connector	12
Silencer	12
Reducing sleeves	13

1. General technical data

Product properties	
Dimensions	Further information can be found in chapter "5. Dimensions" on page 6.
Material	
Actuator stem	Stainless steel 1.4301/304
Seal	NBR
Housing	Stainless steel 1.4301/304
Piston	PA
Further information on materials can be found in chapter "4. Materials" on page 4.	
Performance data	
Rotation angle	90°
Pilot pressure	Single-acting actuator: 4.8...8 bar Double-acting actuator: 3...8 bar
Medium data	
Control medium	Filtered oil-free or lubricated compressed dry air
Control medium specifications	
Dust content	Class 5 (< 40 µm particle size)
Particle density	Class 5 (< 10 mg/m ³)
Pressure dew point	Class 4 (< 3 °C)
Oil concentration	Class 5 (< 25 mg/m ³)
Product connections and communication	
Pilot air ports	G 1/8
Armature-side interface	According to ISO 5211
Control head/Positioner interface	ELEMENT FA03
Environment and installation	
Ambient temperature	-10 °C...+ 60 °C

2. Approvals and conformities

2.1. General notes

- The approvals and conformities listed below must be stated when making enquiries. This is the only way to ensure that the product complies with all required specifications.
- Not all available variants can be supplied with the below mentioned approvals or conformities.

2.2. Conformity

In accordance with the Declaration of Conformity, the product is compliant with the EU Directives.

2.3. Standards

The applied standards which are used to demonstrate compliance with the EU Directives are listed in the EU-Type Examination Certificate and/or the EU Declaration of Conformity.

3. Control functions

Symbol	Description
	<p>Control function A (CF A) Pneumatically operated 2/2-way on/off valve Flow direction above seat Normally closed by spring force</p>
	<p>Control function I (CF I) Pneumatically operated 2/2-way on/off valve on either side Bidirectional Switching position dependent on external control</p>

4. Materials

4.1. Bürkert resistApp

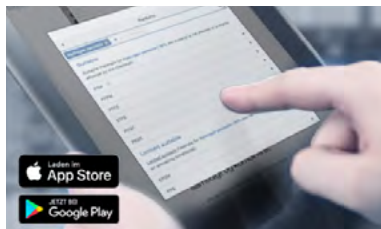

Bürkert resistApp – Chemical resistance chart

You want to ensure the reliability and durability of the materials in your individual application case? Verify your combination of media and materials on our website or in our resistApp.

[Start chemical resistance check](#)

4.2. Material specifications

Central section

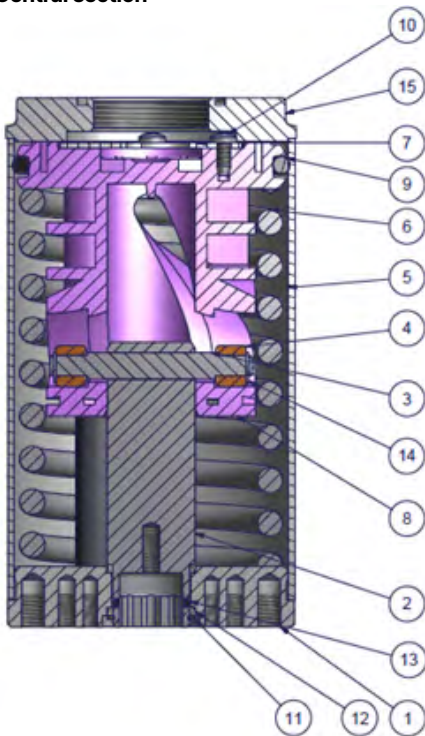

No.	Quantity	Element	Material
1	1	Bottom plate	Stainless steel 1.4301/304
2	1	Actuator stem	Stainless steel 1.4301/304
3	1	Parallel pin	Stainless steel 1.4301/1.4404/ 304/316L
4	2	Roller	20.401
5	1	Housing tube	Stainless steel 1.4301/304
6	1	Compression spring	Edelstahl 1.7102/54SiCr6
7	1	Retaining washer	Stainless steel 1.4301/304
8	1	Piston	PA
9	1	O-ring 72 × 5.2	NBR
10	3	Screw WN E5451 40 x 10-S	Stainless steel A2/404
11	1	Snap ring XFS- 023	Stainless steel 1.4310/302
12	2	Sliding disk	IGLIDUR W300
13	1	O-ring 19 × 2	NBR
14	2	Lock washer DIN 6799 - 5.0	Stainless steel A2/304
15	1	Cover	Stainless steel 1.4301/304

DTS 1000436877 EN Version: E Status: RL (released | freigegeben | valide) printed: 22.01.2026

Interface for ELEMENT control heads and positioners

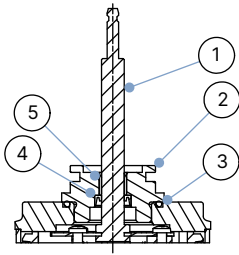

No.	Quantity	Element	Material
1	1	Spindle	Stainless steel 1.4301/304
2	1	Adaptor bolt	Stainless steel 1.4301/304
3	1	O-ring 37.77 × 2.62	NBR
4	1	Stem seal	EPDM
5	1	Socket	DU

Cover

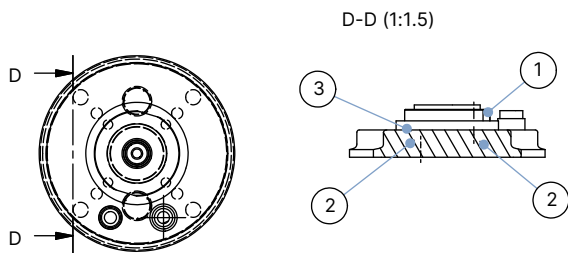

No.	Quantity	Element	Material
1	1	Press-in socket	Stainless steel 1.4301/304
2	1	Seal	EPDM
3	1	Press-in shell	Stainless steel 1.4301/304

Bottom plate

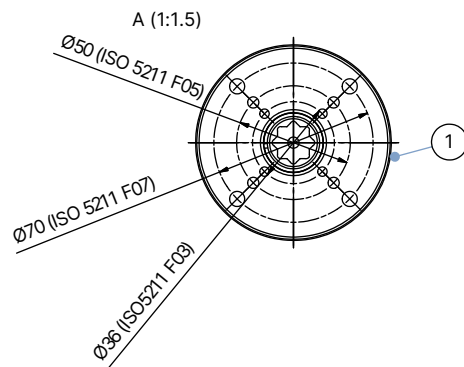

No.	Quantity	Element	Material
1	1	Bottom plate with interface according to ISO 5211	Stainless steel 1.4301/304

DTS 1000436877 EN Version: E Status: RL (released | freigegeben | valide) printed: 22.01.2026

5. Dimensions

5.1. Variant P0

Note:

- Dimensions in mm
- Actuators with the additional indication "Control head/Positioner ready" are equipped with an FA03 interface to be combined with ELEMENT control heads and positioners.

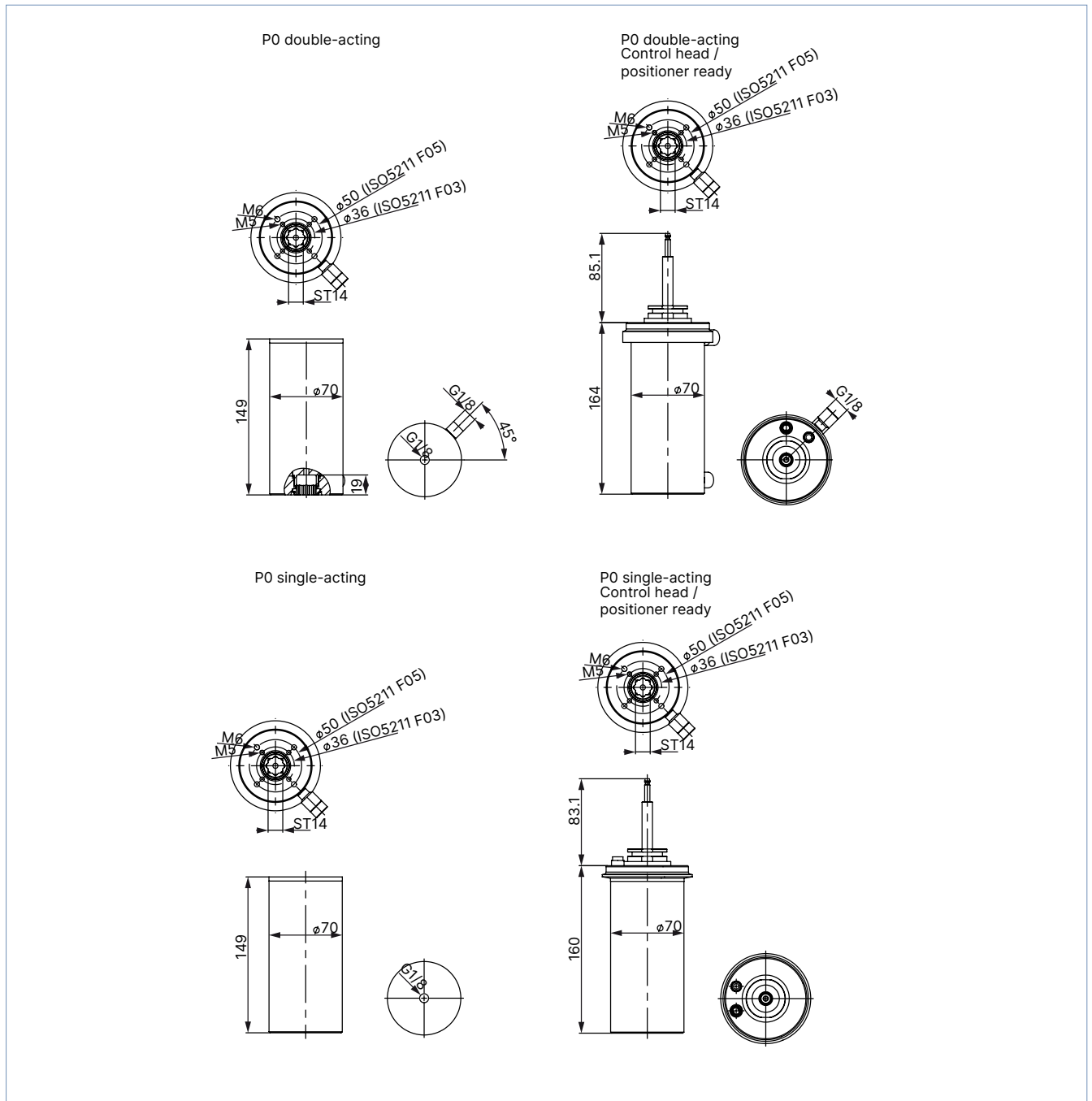

DTS 1000436877 EN Version: E Status: RL (released | freigegeben | valide) printed: 22.01.2026

5.2. Variant P1

Note:

- Dimensions in mm
- Actuators with the additional indication "Control head/Positioner ready" are equipped with an FA03 interface to be combined with ELEMENT control heads and positioners.

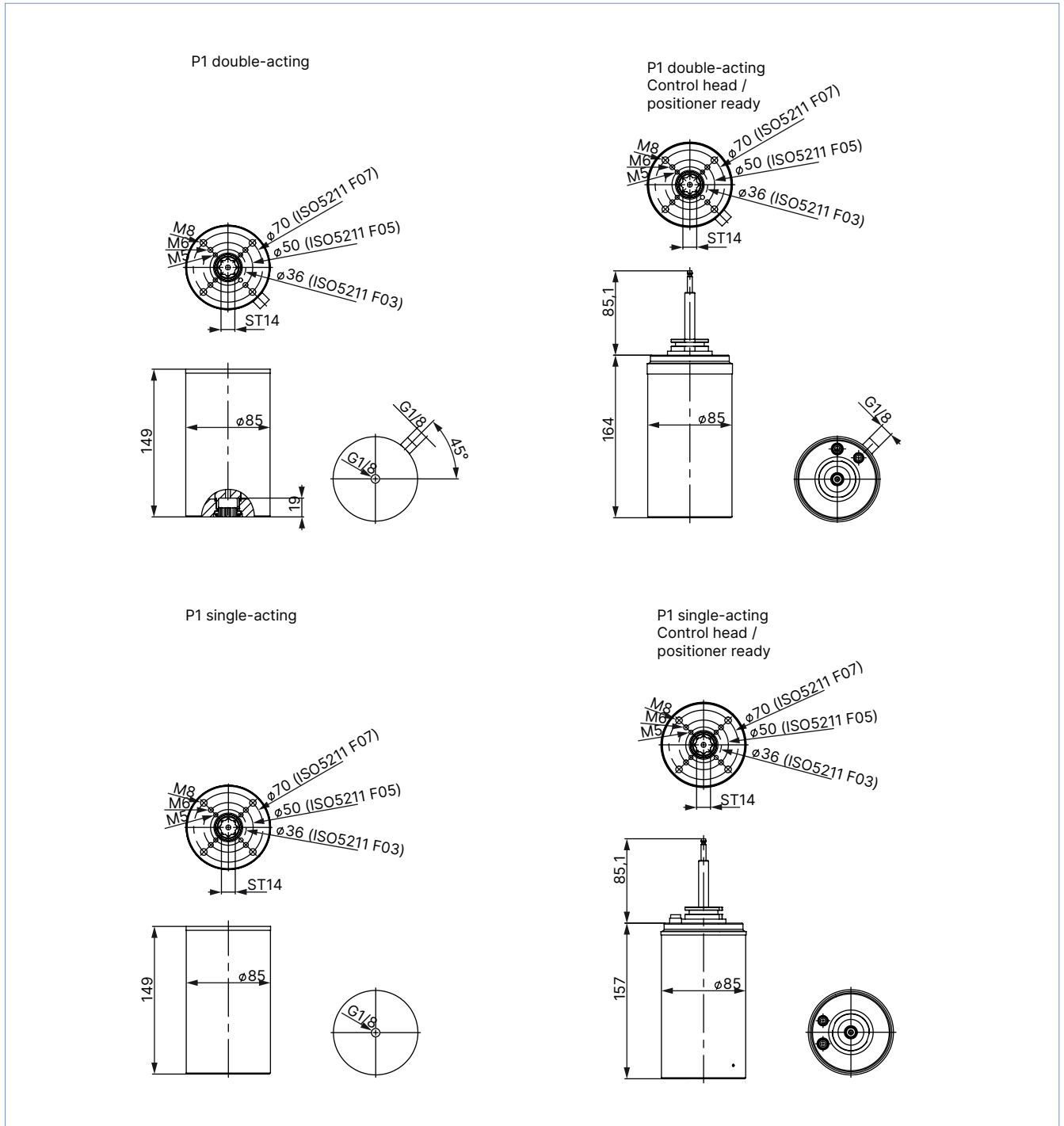

DTS 1000436877 EN Version: E Status: RL (released | freigegeben | valide) printed: 22.01.2026

5.3. Variant P2

Note:

- Dimensions in mm
- Actuators with the additional indication “Control head/Positioner ready” are equipped with an FA03 interface to be combined with ELEMENT control heads and positioners.

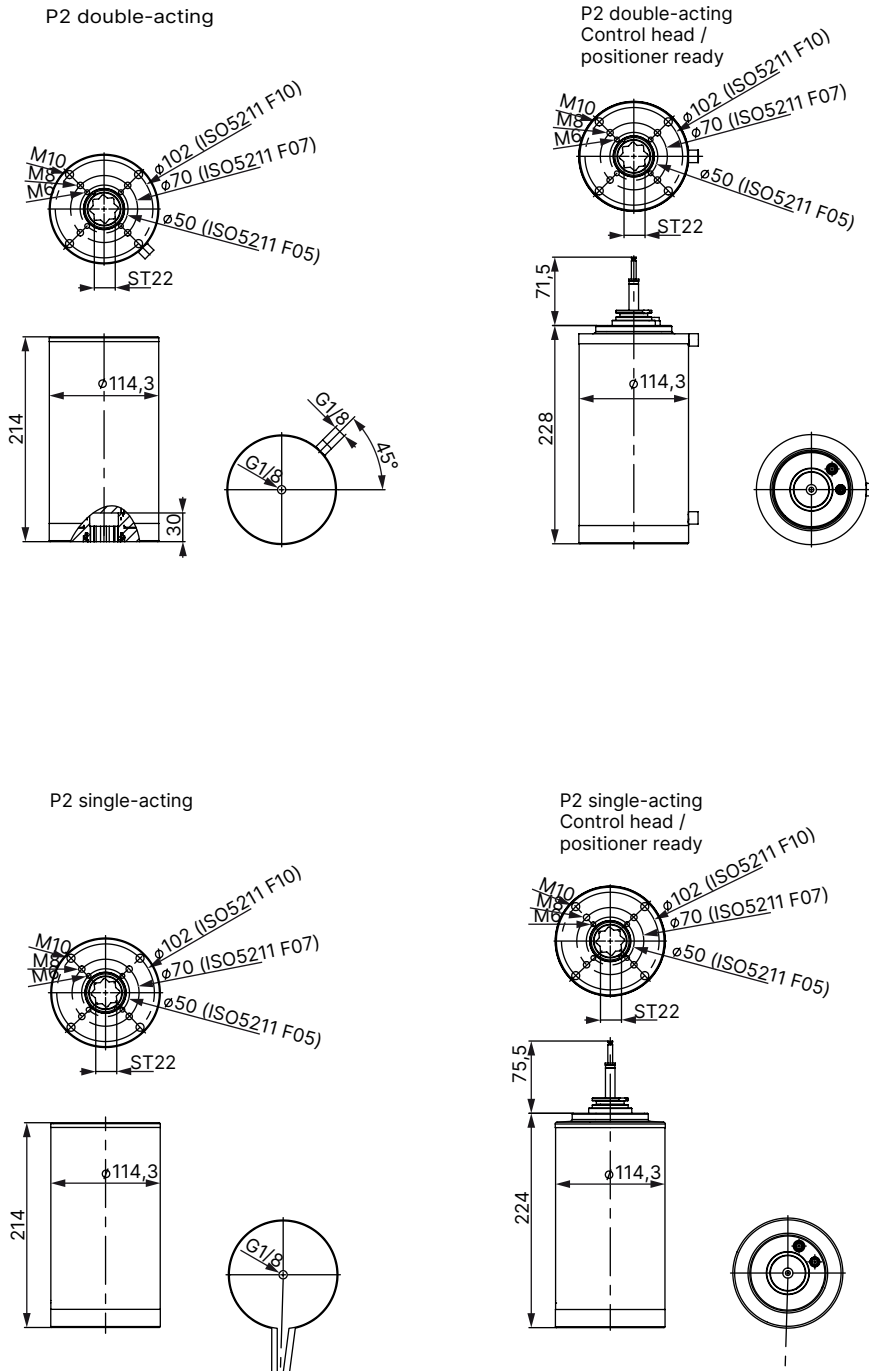

DTS 1000436877 EN Version: E Status: RL (released | freigegeben | valide) printed: 22.01.2026

6. Performance specifications

6.1. Torque chart

Single-acting

Note:

Regarding actuator choice, we recommend a safety torque equal to 1.3 times of the valve maximum torque.

Actuator size	Minimum torque for 6 bar pilot pressure ¹⁾
	[Nm]
P0	10
P1	28
P2	48

1.) For the balanced operation (ratio of the spring torque to the torque generated by compressed air), the actuator has to be operated with 6 bar compressed air. Lower pilot pressures reduce the torque.

Double-acting

Note:

Regarding actuator choice, we recommend a safety torque equal to 1.3 times of the valve maximum torque.

Actuator size	Torque (depending on the pilot pressure)			
	3 bar	4 bar	5 bar	6 bar
	[Nm]	[Nm]	[Nm]	[Nm]
P0	17	21	26	32
P1	26	36	44	50
P2	60	80	90	95

6.2. Air consumption

Actuator size	Control function	Pilot pressure	Air consumption
		[bar]	[l/stroke]
P0	Double-acting	3...8	0.5...1.2
P1			0.8...2.0
P2			1.9...5.0
P0	Single-acting	4.8...8	0.8...1.2
P1			1.2...2.0
P2			3.0...5.0

7. Product operation

7.1. Functional overview

Function	Description
	<ul style="list-style-type: none"> The linear lifting motion of the drive piston is redirected in a 90° rotational movement of the drive stem. The return to the initial position of the single-acting actuators is caused by spring force. For the double-acting actuators, the movement in both directions is caused by compressed air. <p>Note for actuator size P2 in combination with Bürkert control units:</p> <ul style="list-style-type: none"> Position feedback „open“: already at 75° opening angle Control range: 0...75° opening angle

DTS 1000436877 EN Version: E Status: RL (released | freigegeben | valide) printed: 22.01.2026

8. Networking and combination with other Bürkert products

Note:

The actuator of Type 2053 is perfectly suited for the combined use with ELEMENT control heads resp. positioners (Type 8691/8692/8693/8694) as well as quarter-turn valves like ball valves (Type 2651/2654/2657) and butterfly valves (Type 2671/2674). The described combination is named Type 8805.

Example:

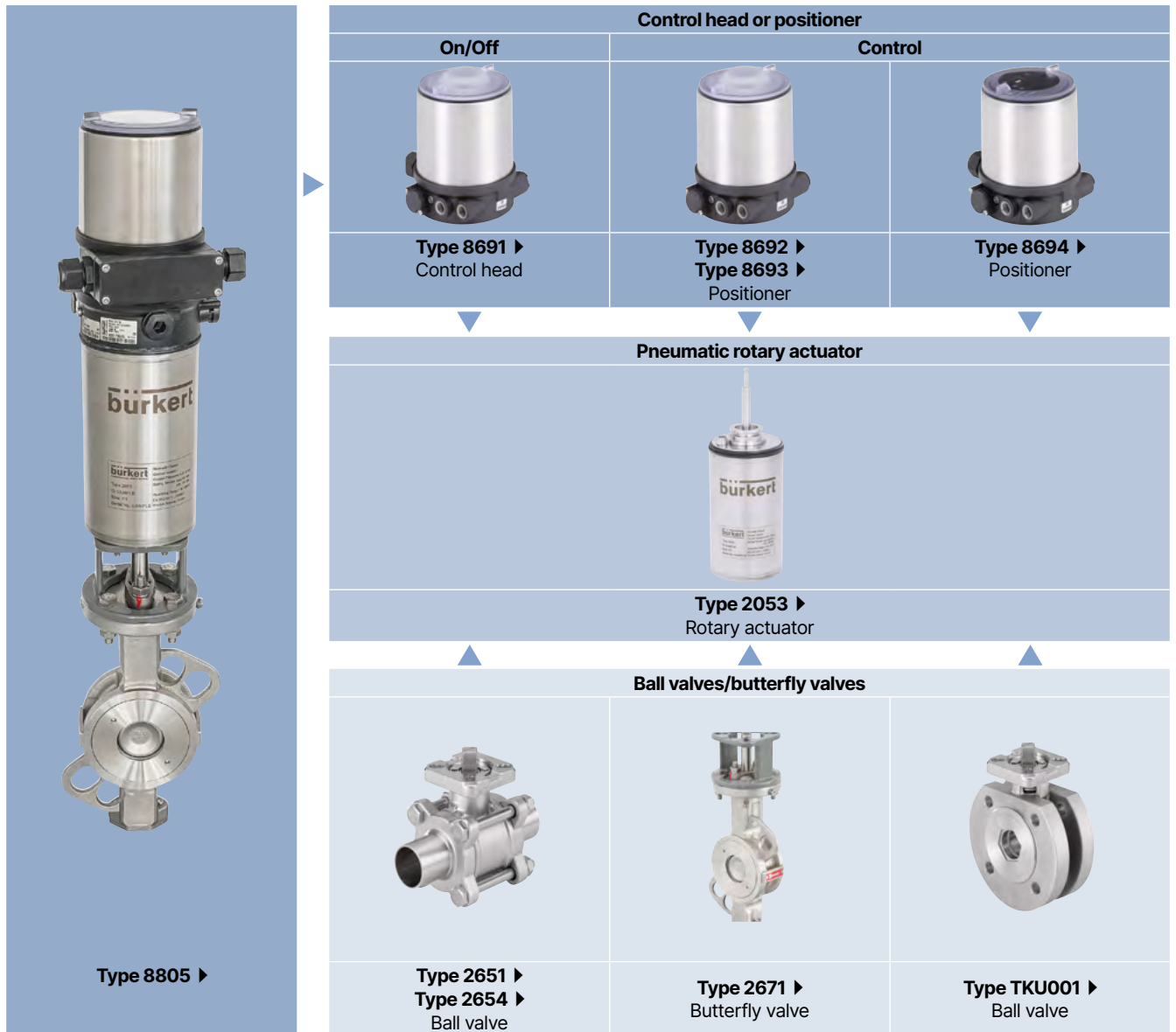

DTS 1000436877 EN Version: E Status: RL (released | freigegeben | valide) printed: 22.01.2026

9. Ordering information

9.1. Bürkert eShop



Bürkert eShop – Easy ordering and quick delivery

You want to find your desired Bürkert product or spare part quickly and order directly? Our online shop is available for you 24/7. Sign up and enjoy all the benefits.

[Order online now](#)

9.2. Bürkert product filter



Bürkert product filter – Get quickly to the right product

You want to select products comfortably based on your technical requirements? Use the Bürkert product filter and find suitable articles for your application quickly and easily.

[Try out our product filter](#)

9.3. Ordering chart

Double-acting, control head/positioner ready

Note:

- For all assemblies of actuator Type 2053 with control unit Type 8691/8692/8693/8694, you need the form seal for control units. The article number can be found in chapter **“9.4. Ordering chart accessories” on page 12.**
- Actuators with the additional indication “Control head/Positioner ready” are equipped with an FA03 interface to be combined with ELEMENT control head and positioners.

Actuator size	Interface according to ISO 5211	Double square	Weight	Article no.
		[mm]	[kg]	
P0	F03/05	14	2.15	369736
P1	F03/05/07	14	2.95	369740
P2	F05/07/10	22	6.65	369744

Double-acting

These actuators **cannot** be combined with the ELEMENT control heads and positioners.



Actuator size	Interface according to ISO 5211	Double square	Weight	Article no.
		[mm]	[kg]	
P0	F03/05	14	1.9	369734
P1	F03/05/07	14	2.7	369738
P2	F05/07/10	22	6.3	369742

DTS 1000436877 EN Version: E Status: RL (released | freigegeben | valide) printed: 22.01.2026

Single-acting, control head/positioner ready



Note:

- For all assemblies of actuator Type 2053 with control unit Type 8691/8692/8693/8694, you need the form seal for control units. The article number can be found in chapter "9.4. Ordering chart accessories" on page 12.
- Actuators with the additional indication "Control head/Positioner ready" are equipped with an FA03 interface to be combined with ELEMENT control heads and positioners.

Actuator size	Interface according to ISO 5211	Double square	Weight	Article no.
		[mm]	[kg]	
P0	F03/05	14	2.2	369735 
P1	F03/05/07	14	3	369739 
P2	F05/07/10	22	6.7	369743 

Single-acting

These actuators **cannot** be combined with the ELEMENT positioners.

Actuator size	Interface according to ISO 5211	Double square	Weight	Article no.
		[mm]	[kg]	
P0	F03/05	14	1.95	369733 
P1	F03/05/07	14	2.75	369737 
P2	F05/07/10	22	6.4	369741 

9.4. Ordering chart accessories

Form seal for control units of Type 8691/8692/8693/8694

Note:

For all assemblies of actuator Type 2053 with control unit Type 8691/8692/8693/8694, you need the form seal for control units.

Description	Article no.
Form seal for control units of Type 8691/8692/8693/8694	60014507 











Angled connector

Description	Article no.
Angled push-in fitting G 1/8, nickel-plated brass	780082 

Silencer

Description	Article no.
Silencer G 1/8	780779 

Reducing sleeves

Description	Article no.
Reducing sleeve double square/square 14/9 mm	665288 
Reducing sleeve double square/square 14/11 mm	665289 
Reducing sleeve square/square 17/14 mm	665290 
Reducing sleeve double square/square 17/14 mm	773348 
Reducing sleeve double square/square 17/11 mm	773343 
Reducing sleeve square/square 22/19 mm	773836 
Reducing sleeve double square/square 22/17 mm	684858 
Reducing sleeve double square/double square 22/14 mm	666684 
Reducing sleeve double square/square 22/11 mm	773344 
Reducing sleeve double square/square 27/22 mm	774594 
Reducing sleeve square/square 27/19 mm	774279 
Reducing sleeve square/square 27/17 mm	774193 